



INDIAN AGRICULTURAL
RESEARCH INSTITUTE, NEW DELHI.

287 54/36.

I. A. R. I. 6.

MGIPC—S1—6 AR/54—7-7-54—10,000.

CONTENTS

PART I

- Notes on the Nudibranchiate Mollusca from the Vancouver Island
Region (Plate I) 1
CHAS. H. O'DONOGHUE
- A Synchronous Rectifier for the Secondary Currents of an Induction
Coil (Plate II) 13
H. BONIS
- The Ecology, Food-relations and Culture of Fresh-water
Entomostraca 15
A. BROOKER KLUGH
- The Nearctic Species of the Genus *Rhaphium* Meigen
(Dolichopodidae, Dipt.) (Plates III to VI) 99
C. H. CURRAN

22754 / 36.

VOLUME XVI

1927-1928

NOTES ON THE NUDIBRANCHIATE MOLLUSCA FROM THE VANCOUVER ISLAND REGION

V. Two new species and one new record.

By CHAS. H. O'DONOGHUE, D.Sc., F.Z.S., F.R.S.C.

The following notes relate to three forms taken in the vicinity of the Biological Station, Nanaimo, B.C., during the summer of 1925. Collecting was not started so early as in previous years, and this summer stands out by the paucity of species and individuals found. They are all quite new to the region. One was recorded previously by MacFarland (2) from Monterey but not north of California, so that the present record extends its range very considerably northwards. The other two are apparently entirely new.

In the previous series of notes (5 and 7-9) of which this is a continuation, 44 species of Nudibranchs were recorded from the Vancouver Island region, and so the present addition brings the total up to 47, of which 27 belong to the Holohepatica and 20 to the Cladohepatica. Another paper (8) dealt with all the members of this group of Mollusca that have so far been recorded from the whole of the Pacific Coast of North America from the Isthmus of Panama to the north of Alaska and discussed their distribution. The number of distinct species there considered was 101. Since that list was compiled, and indeed since the following notes were written, MacFarland (4) has recorded two more forms (both Acanthodorids), both from California, so that with those and the two now described the total must be raised to 105. Furthermore, the number of species common to California and Vancouver Island was 10, but it must now stand as 11.

It is interesting to note that such a large proportion of the total from the coast (i.e. 47 out of 105) has been obtained in the Vancouver Island district since no collecting has been done on the oceanic coast on the west side of the island, and circumstances have not permitted of collecting during April and very early May, at which time one would expect to obtain a larger number of species than later.

My thanks are due to the Biological Board of Canada, at whose station at Nanaimo the following forms were collected.

radulae. In *A. atrogriseata* the radula has 26-27 rows with a formula 4.1.0.1.4, whereas in *A. columbina* it has 40-43 rows with a formula 5.1.0.1.5.

Acanthodoris armata sp. nov.

Body. The body is typically doridiform and regularly oval in outline. The mantle is fleshy and well developed, extending beyond the foot all round save that the tip of the latter projects during locomotion. The whole dorsum is covered with papillae of various sizes which, if anything, are slightly more numerous towards the margin.

Spicules. This species is particularly noteworthy because of the plentiful development of spicules in the skin. These take the form of relatively large spindle-shaped structures and may be simple or branched. When simple they are sometimes almost straight, but more generally boomerang shaped, and, when branched, they possess one or two branches near the middle of their length. The whole surface is provided with a few low, pointed projections. The spicules which guard the sides of the papillae are usually slightly smaller and smoother than those of the body; they have a median branch which projects into the papilla. The spicules are arranged in a characteristic manner. In the mid-dorsal region they lie with their long axes transversely; around this is a band where they are arranged parallel with the margin, and then around the margin itself they are disposed radially and are very plentiful. Each papilla has a group of from 6-12 running up its sides and projecting slightly above it. The whole armature is far more strongly developed than in any other species of *Acanthodoris* from this region that has been investigated previously.

Colour. The whole animal is a pale creamy white, but the presence of the papillae and spicules gives a kind of texture to the skin.

Dimensions. The specimens procured were all small, the largest measuring 4 mm. long by 2 mm. wide and 1.25 mm. high.

Head. The head is well marked and broad and is continued out laterally into a pair of triangular oral lobes. The mouth appears as a longitudinal slit.

Foot. The foot is well developed, transversely truncate at the anterior end, where it bears a slight median indentation, and bluntly pointed posteriorly.

Rhinophores. The rhinophore is provided with a cylindrico-conical perfoliate clavus, but it is so small when contracted that the number of leaves could not be ascertained satisfactorily. Each is retractile within a sheath whose margin does not appear to be guarded by papillae.

Branchiae. The branchiae consist of 9 tripinnate plumes arranged in a rough circle and are not retractile within a sheath. The anal papilla lies in the middle line, within the circle towards its hinder edge and is guarded by 4 or 5 spines.

Radula. The radula is pale coloured, relatively much broader than is general in the genus and contains 28-30 rows of teeth. The rachis is bare and the lateral teeth eight on each side, of which the innermost is much larger than the remainder, so that the formula reads 7.1.0.1.7. The innermost lateral tooth has a roughly oblong base, relatively much more drawn out in the longitudinal direction than in any other *Acanthodoris*. At its antero-lateral corner it bears a strong, curved spine. Some distance back from the point this bears a lateral ridge with from 9-10 tiny denticles on it. The lateral teeth, usually seven in number, although the outermost may be missing, are noticeably smaller. The fourth one of the row is the largest and the others diminish in size on both sides of this. The outside one, when present, is much smaller than any of the others, and consists almost entirely of the basal plate. The plate is approximately oval, but in 3-6 it is truncated posteriorly and bears a median point. Each base bears at its anterior end a raised flange with a curved, free border directed posteriorly. Generally in the *Acanthodoris* these outer lateral teeth are small and altogether not longer than the spine of the inner tooth beneath or inside which they lie. In the present species, however, they occupy a length nearly three times that of the spine of the large tooth, which only extends out beyond the second from the inside. Thus, as noted above, the radula as a whole is broader than customary in the genus.

A labial armature is apparently present, but it was too small to make out its details.

The genital aperture is high up on the right side of the body beneath the mantle.

Habitat. The specimens were obtained at False Narrows reef at low tide and were all found upon the Bryozoan *Flustra lichenoides* whose polyps apparently furnish the food of this form.

Notes. The present species calls attention to a phenomenon that has been noticed in several other doridiform nudibranchs. The opaque creamy white animal with the texture on it produced by the papillae is practically invisible when upon *Flustra lichenoides*. Of a form, somewhat similar in appearance, *Doridigitata maculata* (*Doris echinata*) it was previously recorded that "The general colour of the whole animal is an opaque white with from a dozen to forty small spots of a warm brown colour scattered irregularly over the dorsal surface. . . . Very

minute specks of the same colour cover the dorsum but not the papillae". This is a larger animal, and the presence of these spots helps to conceal it, for in the bryozoan colony the brown bodies show as small brownish spots, and in addition we find numerous brown diatoms growing over the zoarium. The result is that, while a large nudibranch of uniform colour would be readily distinguishable, when it is broken up by larger and smaller brown dots it is far harder to distinguish. A similar relationship holds between a *Corambe* (species not yet determined) and *Membranipora villosa*.

It would perhaps be going too far to suggest that these are examples of protective or concealing colouration because, in general, the typical doridiform nudibranch does not appear to be attacked by any other animal, and it is rather the fashion of the day to scoff at such phenomena. In *A. armata* in particular and *D. maculata* to a certain extent the dorsum and mantle are so well supplied with spicules that further protection would seem superfluous. The fact remains, however, that animals coloured as these are, are quite difficult to distinguish; if they are on their particular bryozoon they appear part of it, and if upon a frond of alga or a stone they look like a small colony.

Lastly there remain for notice certain features in the present species. In many respects it is a typical *Acanthodoris*, but it differs from other members of the genus *inter alia* in the lack of papillae on the rhinophore sheaths, the relatively wider radula, the more elongated base of the first pleural tooth and the relatively much larger and longer row of outer pleural teeth. We feel that these points while differentiating it from other forms are hardly sufficient to justify creating a special genus for it. For the present then it will be included with the other species under the name *Acanthodoris armata*.

It has been noted above that these notes were written before the appearance of MacFarland's excellent paper (4) on "The Acanthodorididae of the California Coast", and it is to be regretted that the information herein was not available to that author. He points out that the genus reaches great diversity in the Pacific waters and gives the following list of species recorded.

1. *A. pilosa* (O.F.M.). Alaska.
2. *A. pilosa* var *albescens* Bergh, Alaska. Vancouver Island.
3. *A. pilosa* var *purpurea* Bergh, Alaska.
4. *A. coerulescens* Bergh, Alaska.
5. *A. hudsoni* MacFarland, California.
6. *A. brunnea* MacFarland, California.
7. *A. rhodoceras* C & E. California.

8. *A. nanaimoensis* O'Donoghue, Vancouver Island.
To these the following may now be added:—
9. *A. lutca* MacFarland, California.
10. *A. columbina* MacFarland, California.
11. *A. atrogriscata* described above.
12. *A. armata* described above.

Family AEGIRETIDAE

Genus AEGIRES Loven 1844.

Aegires Lovén, Opvers k. vet. akad. Forh (Stockholm) Vol. 1. March 1844, p. 49.

Type of monotypy, *Polycera punctilucens* d'Orbigny, 1837.

Aegires albopunctatus MacFarland, Proc. Biol. Soc. Washington, vol. XVIII, 1905, p. 45, and (3, 1906, p. 133).

Body. The body is limaciform and somewhat spindle-shaped; it is blunt at the front end, bluntly pointed at the hinder end, and reaches its maximum width in the region of the branchiae about three-fifths of the way back. The head is fairly high, the body slopes up to the level of the branchiae and then suddenly falls. The animal is fairly hard to the touch owing to the presence of a large number of spicules in the skin. The dorsum is not distinctly marked off from the sides of the body, and the whole is furnished with a series of ridges, regularly arranged and bearing a number of blunt processes. One of these ridges starts as a prominent projection in the mid-dorsal line on the top of the head in front of the rhinophores. It passes backwards bearing another process and then at the level of the rhinophores splits into two which run back to the outer side of the branchiae, each bearing 5-6 large processes and 3-4 lower ones. Just in front of the branchiae in the middle line are from 1-3 projections. Another ridge arises on each side behind the rhinophores, level with their mesial edge, and runs back parallel with the others not quite as far as the level of the front of the branchiae. This bears three large and three low projections. A third lateral ridge commences below and in front of the rhinophore on each side and passes backwards behind the branchiae, where it bends mesially to end with its fellow in a common median process. On this ridge there are eight or nine large and four lower projections. Lateral to this again are from six to eight processes lying in a line but not arising from a ridge. The cephalic veil is provided with a double row of low projections, and it also has one or two larger ones on each side which lie on a ridge passing upwards and inwards to join or to end

near the anterior processes of the middle ridges. In addition to all these there are a few irregularly arranged projections, particularly on the tail, and a special group around the rhinophores.

Colour. The whole animal is of a whitish grey colour, caused by the presence of innumerable, tiny specks of intense, opaque white over a greyish white background. It bears a series of conspicuous dead black spots arranged between the ridges which themselves appear lighter by contrast. The clavus of the rhinophore is of a golden yellow.

Dimensions. The largest specimen measured 17 mm. long by 5.5 mm. wide and 4.5 mm. at its highest point.

Head. The head is relatively small, rounded and completely hidden from above by the thick outstanding cephalic veil. It is separated by a deep groove from the foot and continued out ventro-laterally as broad, leaf-like, triangular flaps which are coloured yellow on the dorsal surface of their tips. The mouth is a short longitudinal slit.

Foot. The foot is well developed, sharply marked off from the body, truncated transversely at its broad anterior end and passes back gradually into a somewhat pointed tail.

Rhinophores. The rhinophore is long and cylindrico-conical with a rounded tip. About seven-eighths of its length consists of the yellow coloured clavus which is wrinkled but not properly perfoliate. It is completely retractile within a sheath guarded by papillae. There are four large papillae joined together and so forming a sort of wall around the anterior, posterior and lateral sides, but no such structures occur on the mesial side, where the margin is quite smooth and low. In life the rhinophores are held almost upright; when retracted the sheaths close and the papillae are bent in over the top of it as if to form an additional protection.

Branchiae. The branchiae consist of three plumose tripinnate leaves arranged in a semicircle. Each is very retractile and guarded on the outside by a stout, digitiform branchial appendage almost as long as the plume when it is expanded. When the branchiae contract the appendages close down over them in a very characteristic manner, the whole forming a very striking appearance on the dorsum.

The centre of the semicircle is occupied by the relatively large anal papilla, its margins marked by a series of radiating folds. The renal aperture lies at the right anterior base of the papilla.

The reproductive opening lies on the right side of the body just behind the level of the rhinophores and immediately below the most lateral of the longitudinal ridges. The glans penis is cylindrical and armed with numerous tiny hooks.

Radula. The radula is broad, well developed and possesses a thin chitinous basal sheet extending well beyond the limits of the teeth. It contains seventeen half rows of teeth on each side arranged alternately. There is no median tooth and the formula of the first row is 9.0.7; of the second row 17.0.14, and of the more posterior rows 20.0.20. The teeth throughout are of a similar pattern, being simple uncini; the innermost is the smallest and the next four or five increase fairly rapidly in size.

Buccal armature. The lips are guarded with a thin curved disc of brownish yellow chitin. It is perforated by a T-shaped opening. Just inside the aperture the chitin becomes very much thickened and bears a large number of tiny chitinous rods. In addition to this the upper side bears a relatively large shield-shaped plate of chitin, thicker than the buccal disc. Apparently the food is pressed against this while being rasped by the radula.

Habitat. The specimens were obtained in 6-12 fathoms of water off a coarse gravelly and muddy bottom together with some seaweeds in Departure Bay.

Notes. This appears to be the same species as that described by MacFarland as *Acgires albopunctatus* although it presents some points of difference. The large spots on the dorsal surface are black, not brown, the papillate ridges are regularly arranged. Most interesting however is the difference in habitat. MacFarland (3) reports it as occurring under overhanging rocks at low tide and "especially common upon sponges in a tunnel-like grotto". The present material was obtained well below low-tide level immediately in front of the Station on a bottom where there are no sponges, and so far as can be ascertained it has never been collected on the shore; as a matter of fact it has not previously been recorded north of California. Another circumstance makes this still more remarkable, for after capture two of the animals laid pieces of egg ribbon with fertile eggs. They were therefore near spawning time when many other Nudibranchs migrate shorewards; also, they were taken near the end of July, when most other species have finished spawning.

MacFarland does not remark on the hardness of the body due to the extraordinary development of spicules.

Onchidorus fuscus (O. F. Muller) 1776.

The present species has been dealt with previously from the present area under the name *Lamellidoris bilamellata* (5, p. 174), (6, p. 126), (10, p. 139) and (8, p. 24) but calls for a further note here. My friend,

Mr. G. A. Hardy, of the Provincial Museum, Victoria, sent me some specimens of this for confirmation and examination. They were obtained by him from the bottom of the dry dock at Esquimalt, thus providing a new locality for the species. They were further noteworthy in being of exceptionally large size, measuring 31 mm. long even when preserved.

The range of colour variation in this species is quite large and has been dealt with previously (6, p. 126), but one of the present specimens, Mr. Hardy informs me, was practically white, thus presenting a far paler form than has been recorded before. Another interesting point is to be noticed, for while this species has been previously reported as spawning from the end of May to the middle of June (10, p. 139) the present examples were collected in February and some were spawning and others had spawned already.

It may be recalled that this species, under the name *Lamellidoris bilamellata*, was recorded from Vancouver Island as early as 1877 by Abrahams (1a).

Since the publication of a list of species and a bibliography of the Nudibranchs of the Pacific Coast of North America in this journal a paper by Kelsey (2a) has come to light which should have been included in that list. This paper contains the names of nineteen Nudibranchs occurring at San Diego, but as three of them are synonyms it reduces the actual number to sixteen. I do not think Kelsey's paper, although published in 1907, is referred to in any other work dealing with this group on the coast, and yet it is of interest because ten of the species are recorded from the San Diego district for the first time, a fact that is indicated below by putting an asterisk before their names. They are as follows: —

- *1. *Sphaerostoma palmeri* (Cooper) recorded as *Tritonia palmeri* p. 51.
2. *Diaulula sandiegensis* (Cooper) recorded as *Doris sandiegensis* and as *Diaulula sandiegensis* p. 39.
3. *Aldisa alabastrina* (Cooper) recorded as *Doris alabastrina* p. 39.
4. *Aldisa sanguinea* (Cooper) recorded as *Aldisa sanguinea* p. 33 and as *Doris sanguinea* p. 39.
- *5. *Cadlina flavomaculata* MacFarland p. 35.
- *6. *Cadlina marginata* MacFarland p. 35.
7. *Glossodoris californiensis* (Bergh) recorded as *Chromodoris californiensis* Bergh and as *Chromodoris universitatis* Cockerell p. 37.
- *8. *Glossodoris macfarlandi* (Cockerell) recorded as *Chromodoris macfarlandi* p. 37.

- *9. *Glossodoris porterae* (Cockerell) recorded as *Chromodoris porterae* p. 37.
- *10. *Dendrodoris vidua* (Bergh) recorded as *Doriopsis vidua* Burgh (sic) p. 39.
- *11. *Laila cockerelli* MacFarland p. 41.
- *12. *Thecacera velox* Cockerell record as *T. velox* Cockerell (sic) p. 51.
- *13. *Hopkinsea rosacea* MacFarland p. 41.
- 14. *Armina californica* (Cooper) recorded as *Pleurophyllidia californica* p. 47.
- 15. *Flabellina iodinea* (Cooper) recorded as *Acolis iodinea* p. 33.
- *16. *Hermsisenda crassicornis* (Eschscholtz) recorded as *Aeolis opalescens* Cooper p. 33.

LIST OF REFERENCES

- 1a. Abraham, P. S. "Revision of the Anthobranchiate Nudibranchiate Mollusca with Descriptions or Notices of forty-one hitherto undescribed species." Proc. Zool. Soc. Lond., 1877.
- 1. Guernsey, M. "Some of the Mollusca of Laguna Beach". Rep. Laguna Mar. Biol. Lab. May 1912.
- 2a. Kelsey, F. W. "Mollusks and Brachiopods collected in San Diego, California". Trans. San Diego Soc. Nat. Hist., Vol. I, 1907.
- 2. MacFarland, F. M. "A Preliminary Account of the Dorididae of Monterey Bay, California". Proc. Biol. Soc. Washington, Vol. XVIII, 1905.
- 3. Ibid. "Opisthobranchiate Mollusca from Monterey Bay, California and Vicinity". Bull. Bureau of Fisheries, Washington, Vol. XXV, 1906.
- 4. Ibid. "The Acanthodorididae of the California Coast". Nautilus, Vol. XXXIX, Nos. 2 and 3, 1925 and 1926.
- 5. O'Donoghue, C. H. "Nudibranchiate Mollusca from the Vancouver Island Region". Trans. R. Can. Inst., Vol. XIII, 1921.
- 6. Ibid. "Notes on the Nudibranchiate Mollusca from the Vancouver Island Region. I. Colour Variations". Trans. R. Can. Inst., Vol. XIV, 1922.
- 7. Ibid. "Idem III. Records of Species and Distribution". Trans. R. Can. Inst., Vol. XIV, 1922.
- 8. Ibid. "Idem IV. Additional Species and Records". Trans. R. Can. Inst., Vol. XV, 1924.

9. Ibid. "A List of the Nudibranch Mollusca recorded from the Pacific Coast of North America, with a note on their Distribution".
Trans. R. Can. Inst.
10. O'Donoghue, C. H., and O'Donoghue, E. "Notes on the Nudibranchiate Mollusca from the Vancouver Island Region. II. The Spawn of certain Species".
Trans. R. Can. Inst., Vol. XIV, 1922.

EXPLANATION OF PLATE

All figures were drawn with the aid of a camera lucida and at the multiplications indicated.

- Fig. 1. *Acanthodoris atrogiseata* sp. nov.; innermost lateral tooth X circa 335.
- Fig. 2. *A. atrogiseata*; the four outer lateral teeth X circa 335.
- Fig. 3. *Acanthodoris armata* sp. nov.; innermost lateral teeth X circa 800.
- Fig. 4. *A. armata*; the seven outer lateral teeth X circa 800.
- Fig. 5. *A. armata*; four spicules from the dorsum X circa 110.
- Fig. 6. *A. armata*; two spicules from a papilla X circa 110.
- Fig. 7. *Aegires albopunctatus* MacFarland; labial armature front view X circa 35.
- Fig. 8. *A. albopunctatus*; labial armature side view X circa 35.
- Fig. 9. *A. albopunctatus*; four inner lateral teeth X circa 135.

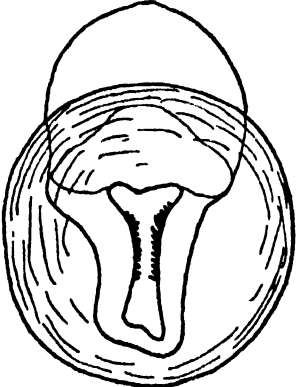
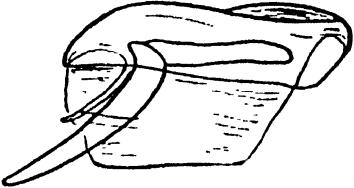
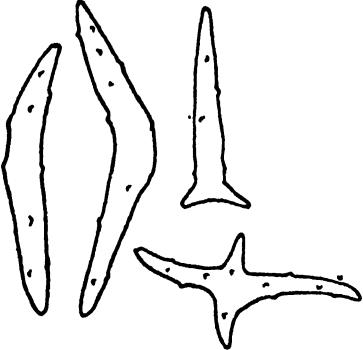
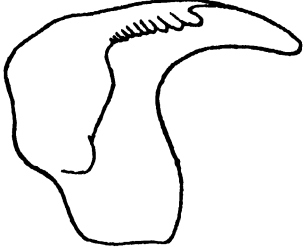
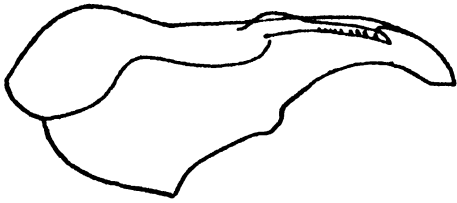

A SYNCHRONOUS RECTIFIER FOR THE SECONDARY CURRENTS OF AN INDUCTION COIL

By H. BONIS,
St. Marys, Ont.

For many purposes it may be desirable to obtain a uni-directional current from the secondary coil of a Ruhmkorff induction machine. I have found the device shown in the accompanying drawing very effective to this end. With two dry cells attached to a coil made up with four layers on the primary and four hundred turns of No. 36 wire on the secondary, I have obtained a perfectly steady direct current, registering five milliamperes on a jewell milliammeter. The synchronous principle involved requires that the long phosphor-bronze vibrating spring (V.) shall touch lightly, when at rest. The bronze clasp placed midway on the fine elastic tape which forms the string of the harp (H). The rest of the harp is of brass. When the machine is in action, this contact is much improved as the spring travels toward the magnetic cone at "break". Hence the current produced in the secondary coil finds a ready path through the circuit marked S.C. (short circuit). On the contrary, at "Make" the vibrator swinging back from the cone and away from the tape leaves a spark gap of at least $\frac{1}{2}$ " between the clasp and itself. The "Make" current of the secondary will consequently pass through the *external* circuit, whose resistance we may suppose to be less than that of the spark-gap. This external circuit ordinarily is represented by the work done by the machine. In the drawing the milliammeter takes the place of this work-resistance. If the milliammeter be joined up to the posts K and P₂ (first detaching the wire joining these posts) it will be found to register a current equal in magnitude and opposite in direction to that flowing between the posts P₂—P₂. This is the "break" current which has been shunted through the short-circuit wires S.C.—S.C. The primary circuit is the usual one, with the exception that the return circuit passes through an insulated bronze clasp on the spring from the platinum-pointed screw to the nearer battery post P, instead of through the spring and post P.

The writer wishes to acknowledge his indebtedness in the testing of this device to Mr. John Tanton, Science Master, St. Mary's Collegiate Institute.

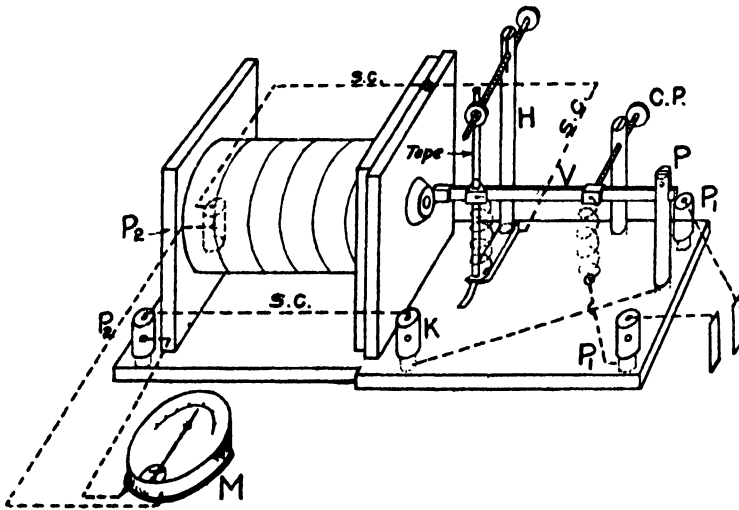

BONIS ON A SYNCHRONOUS RECTIFIER FOR THE SECONDARY CURRENTS
OF AN INDUCTION COIL

THE ECOLOGY, FOOD-RELATIONS AND CULTURE OF FRESH-WATER ENTOMOSTRACA

By A. BROOKER KLUGH,
Queen's University.

INTRODUCTION.

This investigation was undertaken, at the suggestion of Dr. J. G. Needham, to gain information which would lead to the development of a method of raising entomostraca as fish-food.

That these minute crustaceans constitute one of the most important foods of a large number of fresh-water fishes during their early life, and of some species throughout their lives, is generally recognized, and we need not, for the purpose of this paper, do more than refer to some of the more important American literature on this subject.

Forbes (1883) shows that many of the smaller fishes, which in turn serve as food for the larger predaceous species, feed very largely on entomostracans, the percentage of entomostraca in the animal food taken by *Eucalia inconstans* being 50%, by *Pygosteus pungitius* 40%, by *Labidesthes sicculus* 40%, by *Abramis chrysoleucas* 15%, by *Notropis heterodon* 56%, and by *Notropis atherinoides* 19%. The same author (1888) states that 50% of the food of young *Ameiurus natalis* consists of entomostracans, and (1880) that in early life the food of *Micropterus salmoides* is almost exclusively (95%) entomostracans, of young *Lepomis pallidus* 57%, and of young *Percina caprodes zebra* 60%. Ryder (1888) states that the sturgeon (*Acipenser sturio*) when one to two inches long feeds very largely on these planctonic crustaceans. Hankinson (1908) shows that young of *Perca flavescens* feed exclusively on entomostraca. Needham (1908) found that young *Eupomotis gibbosus* 50 mm long had eaten chiefly copepods.

Reighard (1913) lists a specimen of *Notropis cornutus* as having 2/3 of the food-mass cladocerans, and a young *N. hudsonius* as "filled with Cladocera." Baker (1916) gives the food of young *Catostomus commersoni* as 80%, of young *Ameiurus nebulosus* as from 25%-75%, of young *Eupomotis gibbosus* as 90%, and of young *Boleosoma nigrum olmstedii* as 50%, entomostracans. Pearse (1918) found that entomostracans made up the following percentages by volume of the food of some Wisconsin fishes:

<i>Fish</i>	<i>Ostracods</i>	<i>Copepods</i>	<i>Cladocerans</i>
<i>Abramis chrysoleucas</i>	1.9	16.5	57.6
<i>Ameiurus nebulosus</i>	6.7	8.4	33.1
<i>Catostomus commersonii</i>	16.8	14.8	3.6
<i>Cyprinus carpio</i>	7	10.4	3.6
<i>Eucalia inconstans</i>	3.2	19.3	16
<i>Fundulus diaphanus menona</i>	15.8	4.9	15.3
<i>Labidesthes sicculus</i>		8.7	32
<i>Lepomis incisor</i>	.4	7.9	16.6
<i>Micropterus salmoides</i>	.1	2.9	15.1
<i>Notropis heterodon</i>	.5	11	33.4
<i>Perca flavescens</i>	.4	7.8	17.6
<i>Pimephales notatus</i>	.3	2.6	25.1
<i>Pomoxis sparoides</i>	12	21.6	13.6
<i>Roccus chrysops</i>	.4	29.6	16.3
<i>Umbra limi</i>	23.1	3.6	1.3

Pearse and Achtenberg (1920) state that Cladocera form 20% and Copepoda 1.1% of the total food for the year of *Perca flavescens*. Clemens and Bigelow (1922) after examining the contents of the digestive tracts of 211 ciscoes of the following species, *Leucichthys criensis*, *L. artedi*, *L. sisco huronius*, *L. prognathus*, *L. harengus* and *L. ontariensis*, state that "Daphnia formed the great bulk of the contents" and "in many cases Daphnia alone were present". Moore (1922) says "the most important single item in the food of the young smallmouth bass is water-fleas", and lists cladocerans as among the most important food of young *Ameiurus nebulosus*, *Leucichthys osmeriformis*, *Ambloplites rupestris*, and *Notropis cayuga*. Bigelow (1923) found that the food of young *Catostomus commersonii* from 1.7 to 2.1 cm. in length was chiefly *Daphnia*, *Bosmina*, *Alona* and copepod nauplii.

Kemmerer, Bovard and Boorman (1923) state that *Daphnia pulex* is an important food of *Salmo irideus* and *Pomoxis annularis*.

Clemens, Dymond and Bigelow (1924) show that young whitefish, *Coregonus quadrilateralis* and *C. clupeaformis* feed largely on entomostracans, as do the young of the Pike Perch *Stizostedion vitreum*, and the Northern Sucker, *Catostomus catostomus* and the adults of the Spot-tailed Minnow, *N. hudsonius*.

Leim (1924) mentions copepods as one of the most important foods of the young shad, *Alosa sapidissima*, in fresh water.

In order to be consistently successful in raising any animal it is obvious that one must know the life-history of the animal, and its requirements, not only as to food, but as to all the other factors of

the environment, and one result of four years' experimental work on entomostracans has been to make this fact more obvious than ever. When one turns to the literature on Entomostraca he finds that it is mainly systematic and distributional, in which respects it is very extensive. This is only natural, since taxonomy and distribution form the ground-work for a knowledge of any group of organisms. Entomostracan anatomy is generally treated as a adjunct to systematic studies. The topic which ranks second in entomostracan literature is the life-cycle of certain species; and lastly come some papers on reactions to various stimuli, methods of swimming and feeding and an occasional paper on some physiological topic. In the literature dealing with the distribution and the habitats of Entomostraca there is a considerable amount of data which throws some light on the optimum conditions for existence of various species, and this is especially true of recent ecological studies of different bodies of water and their planctonic inhabitants (v. Birge 1897, Thienemann, 1912. Pearsall, 1922; Wagler, 1923; Naumann, 1923; Kennerer, Bovard and Boorman, 1923; Scott, 1899; Lemmermann, 1897; Reinsch, 1924; Ekman, 1914).

The papers on life-cycles contain data which are suggestive in regard to cultural operations, but, unfortunately, in regard to some of the points which are of the greatest practical importance the conclusions of different authors are diametrically opposed.

In regard to food there are, especially in the older literature, many generalizations, mostly entirely without adequate foundation, and even in recent literature there is a paucity of exact data on this matter. Moreover, there is, in recent literature, complete divergence of opinion as to the rôle which dissolved substances, organic detritus and living organisms play in the nutrition of entomostracans. Thus it will be seen that there is an almost complete lack of precise information in regard to life-cycles, food, and conditions of existence upon which to build a system of entomostracan culture.

The present investigation, which was begun in 1921, was carried on mainly at the Atlantic Biological Station, St. Andrews, N.B., and was aided by a grant from the Honorary Advisory Council for Scientific and Industrial Research. Various phases of the problem were attacked simultaneously, but in this paper the results will be presented under the three headings of the title—ecology, food-relations and culture. It is perfectly evident, however, that these phases overlap to a considerable extent, since food-relations are clearly a part of the ecology of a species, and culture is applied ecology.

ECOLOGY.

The chief points in entomostracan ecology which are brought out by a study of the literature are—

1. Fresh-water entomostracans may be roughly divided into four classes according to the general character of their habitat—(a) those which live in the open water of lakes, (b) those which live among vegetation at the margins of lakes and slow-flowing streams, (c) those which inhabit ponds and permanent pools, and (d) those which inhabit temporary pools (v. Birge, 1897, Herrick and Turner 1895, Vavra 1905, Fordyce 1901, Spandl, 1924).
2. The temperature of the waters plays a part in the distribution of many species (v. Dodds 1917 and 1920, Turner 1910).
3. The temperature acting indirectly through the change produced in the viscosity of the water, brings about cyclic changes in the structure of certain planctonic species (v. Stingelin 1897, Zacharias, 1903).
4. The character of the bottom of ponds influences the distribution of entomostraca (v. Naumann 1921).
5. Hydrogen ion concentration of ponds determines to a certain extent the character of their entomostracan fauna (Reed and Klugh, 1924).
6. The abundance and kind of aquatic vegetation has an influence on the abundance of entomostraca (Pond, 1905; Moore, 1920; Reinsch, 1924; MacKay, 1924).

The phases of entomostracan ecology, exclusive of food-relations, to which attention was given in the present investigation were—

1. Field studies of habitats.
2. The effect of temperature.
3. The effect of salt concentration.
4. The effect of Hydrogen ion concentration.
5. The effect of light.
6. The effect of photo-periodicity.
7. Enemies.

FIELD STUDIES OF HABITATS.

The object of these field studies was two-fold—to find out as much as possible about the conditions most favourable for various species of entomostracans and to ascertain which species were likely to be, by reason of their habitat preferences, most suitable for culture.

Field studies were carried on at various points in Ontario and New Brunswick, mainly in 1921 and 1922. As will be seen the organisms to which the chief attention was given in these field studies were Entomostraca, Protozoa and Algae. The observations on food and on enemies which were made in these studies are reported under these subjects.

Habitat A. A pool near the Biological Station, St. Andrews, N.B. First investigated on June 9th, 1921, and subsequently at various times in 1922, 1923, and 1924. This is a bog pool, surrounded by, but not overshadowed to any extent by, coniferous trees. The amount of water in this pool is dependent upon the precipitation: in early June it is about two feet deep in the middle. In the extremely dry summer of 1921 it dried up completely, then became filled again with the heavy rains of late August. In 1924 this pool went dry in late July, with the exception of the centre, where there was about two inches of water. A remarkable feature of this habitat was that at this time the little water remaining was literally filled with the large ciliate *Spirostomum ambiguum*. Entomostraca were at this time represented only by a few *Scapholeberis mucronata* and a very few *Simocephalus serrulatus*. On Aug. 23rd the pool was completely overflowed by a tremendous rain. In 1922 and 1923 the depth of water in the centre did not fall below six inches. The temperature of the pool varies with the season, and with the amount of water, from 14° C to 22° C. The Hydrogen ion concentration varies with the amount of water in the pool, with the relative development of the algae in the pool and with insolation, the variation being from pH 5.8 to 7.8.

The bottom of the pond consists of peat moss, *Sphagnum cymbifolium*, a Hypnum (which has not yet been found in fruit and consequently was nondeterminable), dead sedges and grasses, some dead leaves of deciduous trees, and intermingled with these, and in places covering the bottom, a flocculent layer, which, on microscopic examination, proved to consist of algae of various species. Growing out of the pool are numerous plants of *Iris versicolor*, and at the edges are *Onoclea sensibilis* and *Osmunda cinnamomca*. The almost complete absence of filamentous algae was a marked feature of this pool.

The following algae were present,—the letters a, c, f, and s, standing for abundant, common, frequent, and scarce respectively—*Tolypothrix tenuis*, s., *Merismopedium glaucum*, s., *Microcystis marginata*, f., *Chroococcus turgidus*, c., *Aphanothece pallida*, f., *Elakatahrix americana*, s., *Characium pringsheimii*, f., *Nephrocystium agardhianum*, s., *Rhaphidium falcatum*, s., *Coelastrum proboscideum*, a.,

Eremosphaera viridis major, c., *Ophiocytium cochleare*, s., *O. parvulum*, s., *Scenedesmus quadricauda*, c., *S. bijuga*, s., *Pediastrum boryanum*, f., *P. tetras*, s., *Volvox globator*, s., *Oedogonium crispum*, s.,—the only filamentous alga present.

The following Protozoans were present—*Halteria grandinella*, c., *Centropyxis aculeata*, c., *Arcella vulgaris*, s., *Diffugia pyriformis*, s., *D. acuminata*, s.

The Entomostraca present were—*Simocephalus serrulatus*, c., *Chydorus sphaericus*, f., *Scapholeberis mucronata*, f., *Cypridopsis vidua*, c., *Cyclops fuscus*, rare.

In this pool in July 1923 all the Entomostraca died out, with the exception of very few *Cypridopsis vidua*. Associated with this disappearance was a large water bacillus. All cultures of animals from this pool also died out at about the same time, and the same, or a very similar, bacillus was found in these cultures. This is suggestive of the possibility that the bacillus was the causative agent.

Habitat B. Pond near Kingston, Ont. Investigated October 20, 28, and Nov. 4, 1921. Average pH 7.6. No work done in summer, consequently no data on temperature range.

This pond had the following emerging vegetation—*Typha latifolia*, c., *Scirpus lacustris*, c., *Alisma plantago-aquatica*, f.

Floating vegetation—*Lemna minor*, c., *L. trisulca*, f., *Wolffia columbiana*, a.

Submerged vegetation—*Myriophyllum spicatum*, f., Algae—*Spirogyra crassa*, f., *Nephrocytium agardhianum*, s., *Gloiococcus mucosus*, s., *Scenedesmus obliquus*, f., *S. quadricauda*, s., *Rhaphidium falcatum*, c., *Pediastrum boryanum*, f.

The following protozoans were present—*Synura uvella*, s., *Phacus longicauda*, s., *P. pleuronectes*, f., *Diffugia corona*, s., *D. pyriformis*, s., *D. acuminata*, s., *Aspidisca costata*, f., *Euplotes carinata*, s., *Coleps hirtus*, f., *Astasia lagenula*, f., *Halteria grandinella*, s., *Trachelius ovum*, s., *Stylonychia pustulosa*, s., *Trachelomonas volvocina*, s., *T. westii*, c., *Petalomonas mira*, s., *Cyclidium glaucoma*, c., *Euglena terricola*, f., *Colpidium striatum*, f., *Arcella vulgaris*, s., *Actinosphaerium eichornii*, s., *Deropyxis amorpha*, s., *Lionotus wrzesniewskii*, s., *Urocentrum turbo*, s., *Paramoecium caudatum*, s., *Oxytrichia pellionella*, f., *O. platystoma*, f., *Actinophrys sol*, s., *Anisonema acinus*, s., *Amoeba limax*, s., *A. proteus*, f., *Vorticella aperta*, f., *Centropyxis aculeata*, f.

Entomostraca present—*Pleuroxus procurvatus*, a., *Simocephalus serrulatus*, f., *S. vetulus*, f., *Chydorus sphaericus*, a., *Cyclops serrulatus*, c., *Cypridopsis vidua*, s., *Cyclopypris forbesi*, s.

Other animals present were—*Lymnaea stagnalis*, c., *L. palustris*, c., *Physa ancillaria*, f., *Glossiphonia stagnalis*, f., *Hydra oligactis*, s.

Habitat C. A marshy pool on the St. Stephen road, near Chamcook Hill, N.B.

The following algae were present—*Pediastrum tetras*, s., *P. boryanum*, s., *Chlamydomonas globosa*, s., *Rhaphidium falcatum*, s., *Microcystis flos-aquae*, s., *Phormidium retzii*, c.

Protozoans—*Ophrydium versatile*, s., *Centropyxis aculeata*, c., *Diffugia acuminata*, s., *Vorticella convallaria*, f.

Entomostraca present—*Simocephalus serrulatus*, s., *Chydorus sphaericus*, c., *Cypridopsis vidua*, c., *Cyclocypris forbesi*, s.

Habitat D. A small pool with a muddy bottom and no large vegetation on the St. George Road near Chamcook Hill. First investigated July 5, 1921, and subsequently in 1922.

The water of this pool was green with—*Scenedesmus bijuga*, *Rhaphidium falcatum* and *Tetradon minimum*.

The only protozoans which could be discovered were—*Astasia lagenula*, s., and *Centropyxis aculeata*, f.

The following entomostracans were present—*Cyclops serrulatus*, a., *Simocephalus serrulatus*, c., *Chydorus sphaericus*, c., *Scapholeberis mucronata*, s., *Ceriodaphnia quadrangula*, s., *Cyclops ater*, rare, *C. fuscus*, s.

Habitat E. A small pool in the rock near the outlet of Chamcook Lake, N.B. Investigated July 5, 1921.

The following algae were present—*Chroococcus turgidus*, c., *Microcystis marginata*, f., *Gloeothece membranacea*, c., *Aphanothece saxicola*, c., *Nostoc comminutum*, s., *Aphanothece stagnina*, c., *Nostoc depressum*, f., *Merismopedium glaucum*, s., *Haematococcus pluvialis*, s., *Stigonema turfaceum*, c., *Tolythrix tenuis*, s., *Calothrix braunii*, s., *Oscillatoria splendida*, s., *Gonium pectorale*, s., *Chlamydomonas communis*, s., *Scenedesmus bijuga*, s., *S. quadricauda*, s., *Eremosphaera viridis*, s., *Rhaphidium falcatum*, s., *Pediastrum tetras*, s., *P. boryanum*, s., *Coelastrum microporum*, s., *Characium ambiguum*, s., *Kirchneriella lunaris*, rare.

Protozoa—*Amoeba proteus*, f., *Amoeba radiosa*, s., *Arcella vulgaris*, s., *Halteria grandinella*, a., *Euplotes charon*, f., *Trichonema hirsuta*, s., *Pontiglusia spectabilis*, s., *Centropyxis aculeata*, f., *Entosiphon ovatum*, s., *Lachrymaria olor*, s., *Diffugia pyriformis*, c., *D. acuminata*, s., *D. labostoma*, s., *Lionotus wrzesiowskii*, s., *Biomyxa vagans*, s., *Hyalosphaenia elegans*, s., *Astasia lagenula*, s.

The following Entomostraca were present—*Cypridopsis vidua*, c., *Chydorus sphaericus*, c.

Habitat F. Pool in a peat-bog near Bocabec Lake, N.B. Investigated Aug. 21, 1921, and July 17, 1923. The water was deep brown and had a pH of 5.8. The edges and part of the bottom of the pool consisted of *Sphagnum* (sp?—not in fruit), and many twigs which were coated with gelatinous algae, these being in most cases an admixture of species, but in some cases pure *Chaetophora attenuatum* and *Drapanaldia platyzonata*.

In addition to these the following algae were present—*Scenedesmus bijuga*, s., *Ophiocytium cochleare*, c., *O. arbuscula*, s., *O. parvulum circinatum*, f., *Dictyosphaerium pulchellum*, r., *Rhaphidium falcatum*, s., *Pediastrum tetras*, s., *Selenastrum minutum*, s., *Microcystis amethystina*, f., *Oscillatoria tenuis*, s.

Protozoans—*Amoeba guttula*, f., *Pleuromonas jaculans*, f., *Arcella vulgaris*, f., *Phacus orbicularis*, s., *Astasia lagenula*, c., *Stentor polymorphus*, s., *Paramoecium bursaria*, s., *Halteria grandinella*, f., *Trachelomonas westii*, s.

Entomostraca—*Scapholeberis mucronata*, c., *Simocephalus serrulatus*, f., *Chydorus sphaericus*, f., *Cypria exculpta*, c., *Cyclops fuscus*, s.

Habitat G. Pool in marsh, fed by a little stream, near Greenlaw, St. Andrews, N.B. Investigated Aug. 2, 1921. The macroscopic vegetation consisted of *Equisetum fluviatile*, *Elocharis acicularis*, and *Nitella flexilis*.

Algae present—*Bulbochaete rectangularis*, f., *Scenedesmus quadricauda abundans*, s., *Rhaphidium falcatum*, s., *Merismopedium glaucum*, s., *Oscillatoria tenuis*, s.

Protozoans—*Astasia lagenula*, s., *Phacus orbicularis*, s., *P. pleuronectes*, s., *Diffugia pyriformis*, s., *Halteria grandinella*, c.

Entomostraca—*Cyclops fuscus*, c., *C. serrulatus*, s.

Habitat H. Pool in old granite (Algoma formation) quarry, Barrie field, Ont. Investigated Oct. 15, 1921, Apr. 20, 1922, and Oct. 20, 1922. This pool is situated near the top of a slight elevation, so that it receives drainage from a limited area only. The depth of the water varies, according to the precipitation, from 8 feet at one end to 15 feet at the other, to 4 feet at one end and 11 feet at the other. The pool is bounded on the north-east, south and south-west by perpendicular walls of granite. The pH of the water varies from 6.2 to 6.8, the fluctuation being both daily and seasonal. It is lowest in the morning and highest in the evening and higher in autumn than spring.

The only emerging vegetation is *Typha latifolia*.

The flora and fauna of this pool showed considerable variation in

the different years, both as to the actual species found, and as to the relative abundance of species.

In Oct. 1921 the following occurred—

Algae—*Aphanothece microscopica*, a., *A. grevillei*, a., *Gloeothece magna*, f., *Microcystis marginata*, c., *Merismobedium glaucum*, c., *Tolypothrix tenuis*, c., *Oscillatoria tenuis*, c., *Oocystis borgei*, s., *Gloiococcus mucosus*, s., *Zygnema pectinatum*, c., *Spirogyra gracilis*, s., *Pediastrum boryanum*, c., *P. tetras*, s., *Sorastrum spinulosum*, s., *Rhaphidium falcatum*, s., *Gomphosphaeria aponina*, s.

Protozoa—*Amoeba verrucosa*, s., *Centropyxis aculeata*, f., *Diffugia pyriformis*, s., *Arcella vulgaris*, s., *Trachelomonas armata*, s.

Entomostraca—*Chydorus sphaericus*, a., *Cypridopsis vidua*, s., *Cyclops serrulatus*, c.

In October 1922 the following were found—

Algae—*Mougeotia genuflexa*, a., *Tolypothrix tenuis*, c., *Microcystis amethystina*, c., *Aphanothece microscopica*, c., *A. grevillei*, c., *Gloiococcus mucosus*, c., *Zygnema pectinatum*, f., *Pediastrum boryanum*, f., *P. tetras*, f.

Protozoa—*Diffugia pyriformis*, f., *Centropyxis aculeata*, f., *Astasia lagenula*, s., *Euglenia intermedia*, s., *Amoeba proteus*, s., *Colpidium striatum*, s.

Entomostraca—*Ceriodaphnia reticulata* a., *Cyprodopsis vidua*, c., *Chydorus sphaericus*, s.

Habitat I. A woodland pool near Aylmer, Ont. Investigated May 23, 1921.

Algae—*Zygnema pectinatum*, s., *Conferva bombycina*, c., *Chlamydomonas communis*, a.

Protozoa—*Centropyxis aculeata*, s., *Vorticella campanula*, s.

Entomostraca—*Daphnia pulex*, a.

Habitat J. Open water of Lake Missanag, Ont. Plancton taken at one metre at 6 p.m. Aug. 30.

The algae present were—*Coelosphaerium kuetzingianum*, c. *Anabaena circinalis*, s.

Entomostraca—*Diaptomus oregonensis*, a., *Cyclops brevispinosus*, c., *Bosmina longispina*, c., *Diaphanosoma leuchtenbergianum*, s., *Polyphemus pediculus*, s.

Habitat K. Large pond at Springwater, Ont. Abundance of submerged vegetation consisting of *Elodea canadensis* and *Myriophyllum spicatum*. Examination of material could not be made at the time, so that specific determination of the algae and protozoans was not satisfactory, and undoubtedly more occurred than listed.

Algae—*Rivularia incrustata*, c., on *Myriophyllum*, *Pediastrum boryanum*, c., *P. tetras*, c.

Entomostraca—*Bosmina obtusirostris*, a., *Scapholeberis mucronata*, c., *Daphnia hyalina*, a., *Simocephalus serrulatus*, f., *Chydorus sphaericus*, c., *Cyclops serrulatus*, a.

Habitat L. Pool on the banks of the Aux Sauble River, at Grand Bend, Ont., May 25, 1922. This pool was in the bed of the river when the river was in flood, and was fed by surface water running down the steep bank.

The Algae present were—*Gloiococcus mucosus*, c., *Scenedesmus bijuga*, a., *S. quadricauda*, a., *Pediastrum boryanum*, c., *Spirogyra* (not in fruit), c.

Protozoans—*Centropyxis aculeata*, c., *Diffugia corona*, f., *D. pyriformis*, f.

Entomostraca—*Daphnia pulex*, c., *Simocephalus serrulatus*, c., *S. vetulus*, s., *Scapholeberis mucronata*, s., *Kurtzia latissima*, s., *Pleuroxus procurvatus*, s., *Chydorus sphaericus*, c., *Cypridopsis vidua*, a.

Habitat M. Plancton taken at surface at reedy margin of Bocabec Lake, N.B., July 17, 1923.

Algae—*Scenedesmus quadricauda*, s., *Gloiococcus mucosus*, s., *Anabaena flos-aquae*, s.

Entomostraca—*Pleuroxus striatus*, a., *P. hastatus*, f., *Ophryoxus gracilis*, s., *Acropterus angustatus*, s., *Sida crystallina*, c., *Polyphemus pediculus*, s., *Scapholeberis mucronata*, s.

Habitat N. A spring pool on the St. Stephen Road near St. Andrews, N.B. Pool shaded, except on west, by trees. Water temperature low—14° to 17° C. pH 6.8. Bottom of fine gravel, with some twigs and one or two dead leaves. Water cloudy with a semi-opalescent appearance.

This is a most interesting habitat because at the first examination there were large numbers of *Cyprinotus incongruens* present and no visible means of sustenance, since there were no algae, protozoans, or other possible food substances, in the material collected. This suggested that the ostracods were possibly living on the material which imparted a cloudiness to the water. Examination of food-balls from the intestines of the ostracods, however, revealed the fact that they consisted of algae. Examination of the water showed that the cloudiness was not due to bacteria, which were present in very small numbers only. A further investigation of this habitat revealed the fact that there was a thin coating of a very fine Tribonema-like alga, much finer than any described species, among which were small colonies of *Palmella*, on some of the

twigs, and that the ostracods were scraping off, and eating, this material. Some of the twigs brought to the laboratory and placed in culture jars with the ostracods confirmed these observations.

Habitat O. Pond in quarry in Pamelia limestone (Black River group of the Ordovician) at Barriefield, Ont. Examined in October 1921, April and October 1922, and May and October 1923. The depth of water varies with the season from 4 to 10 feet in the deepest part. The pH shows a range of from 7.6 to 9.2.

Algae present—*Spirogyra nitida?* (Not in fruit) 1921, *Cladophora fracta*. 1922 and 1923, *Chlamydomonas communis*. All three years.

Entomostraca 1921—*Diaptomus birgei*, a., *Bosmina longirostris*, a., *Ophryoxus gracilis*, s., *Chydorus faviformis*, s.

Entomostraca 1922 and 1923—*Diaptomus birgei*, a., *Simocephalus vetulus*, c., *Cyclops americanus*, c., *Potamocypris smaragdina*, c.

Habitat P. Pool in peat-bog near Bocabec Lake. Examined Aug. 21, 1921, and Aug. 20, 1923. pH, 6.5.

Algae present—*Rhaphidium falcatum*, c., *Scenedesmus bijuga*, c., *S. obliquus*, c., *Ophiocytium cochleare*, c., *Volvox globator*, f., *Pediastrum tetras*, s., *Drapanaldia acuata*, c., *Eremosphaera viridis*, s., *Sorastrum spinulosum*, s., *Chlamydomonas globosa*, s., *Chroococcus turgidus*, s., *Microcystis amethystina*, s.

Protozoans—*Amoeba guttula*, c., *Astasia lagenula*, f., *Halteria grandinella*, c., *Petalamonas alata*, s.

Entomostraca—*Cyclops serrulatus*, f., *Simocephalus serrulatus*, f.

Habitat Q. A pond about 40 yards long by 15 yards wide in the grounds of Sir Thomas Tait near St. Andrews, N.B. The site of this pond was until 1913 a marshy place fed by a spring, and the pond was created by building up one side. The pH of the water was 7 and the temperature during the summer varied from 14° C to 20° C.

The algae most abundant were—*Gloiococcus mucosus*, *Rhaphidium falcatum*, and *Pediastrum boryanum*.

The Entomostraca were—*Diaptomus birgei*, common throughout the summer; *Cyclops fuscus*, scarce in early summer, and becoming commoner later in the season; *Simocephalus serrulatus*, common, near shore, early in the summer, becoming scarcer later; *Chydorus sphaericus*, frequently throughout the season; *Ilyocypris bradyi*, scarce on the bottom.

Habitat R. A pond on top of a rocky headland on Campobello Island, N.B. The chief point of interest about this habitat was the fact that *Ceriodaphnia reticulata* was present in very large numbers in early July, and that all the specimens bore greater or less numbers of a species of *Chlorangium* (apparently undescribed). This infestation

became more marked in August and the numbers of *Ceriodaphnia* showed a marked decrease. Specimens of *Ceriodaphnia* which were badly infested proved non-viable in experimental work. The *Chlorangium* appeared to be deleterious chiefly because, when present in large numbers on the antennae and feet, it hindered the movements of the cladocerans. These facts, while not fully worked out because of the difficulty of getting to this rather remote station, suggest that ectoparasites, such as this *Chlorangium*, may play a part in bringing about a reduction in the numbers of certain entomostracans and may have to be taken in consideration in cultural operations.

Habitat S. A very small pool, about three feet long by a foot wide on the shore of Bocabec Lake, N.B. The remarkable feature of this habitat was that the flora consisted exclusively of *Chlamydomonas communis* and the fauna entirely of *Polyphemus pediculus* which was present in enormous numbers, and which I had always previously found to be a plancton of the waters of lakes. The only other entomostracan was *Alona costata* which was present in small numbers. It is, in my experience, extremely rare to find a habitat which contains practically a "pure culture" of a single plant and a single animal as was the case here.

THE EFFECTS OF ENVIRONMENTAL FACTORS ON ENTOMOSTRACA.

The environment of an entomostracan, or any other organism, consists of a complex of factors, and while the study of natural habitats, especially if long-continued and carried out on a quantitative basis, may yield valuable suggestions as to the action of various factors, it is necessary to resort to the method of experimentation to disentangle the various factors.

The experiments on the effects of environmental factors, especially of temperature, salt concentration and photo-periodism, were conducted mainly with a view to ascertaining how these factors influenced reproduction, and particularly as to what effect they had in the induction of, or the inhibition of, the ephippial condition in cladocerans. The reason why this matter of the onset of the ephippial condition was a centre of interest was because field studies of those species which inhabit pools—and it is these species which are most suitable for culture—had shown that just prior to the drying up of the pools that the great majority of the females were ephippial. Furthermore, it was found that in mass cultures when a large number of the individuals became ephippial the period of reproduction was at an end and the culture rapidly diminished.

Thus it is clearly extremely important to have as much knowledge as possible concerning the factors which bring about the ephippial condition.

The literature concerning the cause of the ephippial condition in cladocerans is extensive—and entirely contradictory. Weismann (1877 and 1880), Ekman (1905), Popoff (1907), Kuttner (1909), Woltereck (1909 and 1911), Papinicolau (1911) and Scharfenberg (1910) hold that the sex cycle in Cladocera is independent of external conditions, while Kurz (1874), Schmankewitsch (1877), Kerhevé (1892) Ostwold (1894), Jssakowitsch (1907), Langerhans (1909), Keilhack (1909), McClendon (1910), Grosvenor and Smith (1913), Agar (1914), Smith (1915) and Banta (1921) contend that the sex cycle is influenced by external conditions. These latter authors correlated the ephippial condition with various factors, Schmankewitsch with increasing salt concentration due to evaporation, Kerhevé with scarcity of food, Ostwold with temperature, Jssakowitsch with temperature and nutrition, Grosvenor and Smith with over-crowding, and McClendon suggested several factors—temperature, nutrition and excretory products. Green (1909) after a study of the life-cycle of *Simocephalus vetulus*, says "The study of general cultures leads to conclusions which are in agreement with results obtained by a study of isolated females, namely, that onset of sexuality is independent of food shortage, and suggests that it is related to accumulations of certain excretions." He contends that in this species no female which has been parthenogenetic ever becomes sexual, but that many females which have produced ephippia become parthenogenetic, and that cultures of *S. vetulus* can never be terminated merely because of the onset of sexuality. In the discussion of the factors which may play a part in bringing about the ephippial condition there is a fact which should not be lost sight of—that these factors may be different in the case of different species. This may, to a certain extent at least, explain the discrepancy in the conclusions of various workers in the cases in which different species have been used. If we consider the effect of temperature in this respect we find that the maximum production of ephippia occurs at a time of rising temperature in the case of those species which inhabit temporary pools, but at a time of falling temperature in the case of limnetic species. Thus it would not seem reasonable that any pronouncement in this matter should be expected to hold for the Cladocera as a whole. In the case of the efficiency of excretory products in bringing on sexuality, it is perfectly legitimate to suppose that this may be a factor in the case of species of small pools, but it seems rather far-fetched to assume that it will be true also of the species of the open waters of lakes—firstly

because these substances would have to be produced in enormous quantities, or be tremendously potent, to affect such large masses of well-stirred water; secondly because these limnetic species are not able to exist under any such impure, oxygen-deficient, condition as is implied by a concentration of excretory products. The same holds good in a consideration of salt concentration as a factor: it may be true for pool species but it cannot be true for limnetic species.

In connection with the technique of these experiments on the effects of various factors it is necessary to anticipate a little and to mention that by the time these experiments were made I had already done a considerable amount of work on the food of various species of entomostracans and had developed methods of growing algae, to serve as food, in any desired quantity and also of growing algae in a culture solution with the animals. Which of these methods was used depended upon the nature of the experiment: in temperature and photo-periodicity experiments the latter method was used, in salt concentration, hydrogen ion concentration and light experiments the former. In the experiments with cladocerans females only were used as initial experimental animals. In each case a number of the animals, usually three (sometimes more, and occasionally but one) were placed in shell vials 4 cm high by 15 mm in diameter, and kept corked, except during feeding and transfers.

In describing the condition of the cladocerans I have adopted certain conventional expressions, which should be explained. "Clear" means without eggs, embryos, or ephippia. "Eggs," unqualified, means that there were parthenogenetic eggs in the brood-pouch. Embryos are designated as being in stage 1, 2, 3, 4, or 5. Stage 1 indicates that the eggs had become slightly longer than wide, that is, they had lost the perfectly spherical appearance of freshly-produced eggs. Stage 2 means that the developing embryo had taken on a "granulated" appearance. Stage 3 indicates that the head of the embryo had become differentiated from the body and the eye was visible. Stage 4 means that the antennae of the embryo, closely folded against the carapace, were visible. Stage 5 means that the embryos were mature, with free antennae, and ready to leave the brood-pouch.

The experiments are listed under the serial numbers which were given them at the time the experiments were set up.

THE EFFECT OF TEMPERATURE.

Ostwald (op. cit) and Wollereck (1909) found that an increased temperature caused daphnids to become mature at a smaller size. McClendon (op. cit.) found that *Daphnia pulex* attained maturity in 35

days at a temperature of 4-10° C, in 14 days at from 19-20° C, and in 6 days at 29-31° C, and that heat hastened the appearance of sexual forms.

Experiment 2R. At room temperature, which varied from 16° to 22° C. One *Simocephalus serrulatus* with 11 eggs; two clear. Set up July 10.

- July 11. 1 with 11 embryos stage 3; 1 with 5 eggs; 1 clear.
 „ 12. 1 with 11 embryos stage 4; 1 with 5 eggs; 1 clear.
 „ 13. 1 with 11 embryos stage 5; 1 with 5 embryos stage 2; 1 with 4 eggs.
 „ 14. 1 clear; 1 with 5 embryos stage 3; 1 with 4 embryos stage 2; 11 young.
 „ 15. 1 clear; 1 with 5 embryos stage 5; 1 with 4 embryos stage 3; 10 young.
 “ 16. 1 with 3 eggs; 1 clear; 1 with 4 embryos stage 4; 15 young.
 „ 17. 1 with 3 embryos stage 1; 1 with 4 embryos stage 5; 1 with 3 eggs; 15 young.
 „ 18. 1 with 3 embryos stage 2; 1 clear; 1 with 3 eggs; 18 young.
 „ 20. 1 with 3 embryos stage 1; 1 clear; 18 young.
 „ 21. 1 with 3 embryos stage 2; 1 clear; 17 young; some nearly adult size.
 „ 22. 1 with 3 embryos stage 2; 1 with 3 eggs; 17 young.
 „ 23. 1 with 3 embryos stage 5; 1 with 3 eggs; 16 young.
 „ 24. 1 clear; 1 with 3 eggs; 19 young of various sizes.
 „ 25. 1 with 2 eggs; 1 with 3 embryos stage 1; 19 young, some of adult size. Experiment discontinued.

Experiment 18Q. Raised temperature. Set up July 14th. Three individuals of *Simocephalus serrulatus*, one with 5 eggs, one with 5 embryos stage 5, and one with 3 embryos stage 5.

- July 14. Temperature 30° C.
 „ 15. „ 9 A.M. 25°: Noon 29°. One with 9 eggs, one with 2 eggs, one with 3 embryos, 8 young.
 „ 16. „ 9 A.M. 29: Noon 30: 5 P.M. 35. One with 11 embryos, one with 10 embryos, one clear, 18 young.
 „ 17. „ 9 A.M. 26: Noon 31: 5 P.M. 30. One with 4 early embryos, one clear, one dead. Very numerous young—too many to count accurately.
 „ 18. „ 9 A.M. 26: Noon 33: 5 P.M. 30. Two clear. Very numerous young.

- July 19. ,, 9 A.M. 24: Noon 30: 5 P.M. One adult clear,
the other dead. Very numerous young.
- ,, 20. ,, 9 A.M. 29: Noon 31: 5 P.M. 31. Last adult
dead. Very numerous young.

Experiment 18R. Raised temperature. Set up July 14th. Three individuals of *S. serrulatus*, one with 11 embryos stage 2, two with 8 embryos stage 4.

July 14. Temperature 30 C.

- ,, 15. ,, 25, 29, and 30. One with 12 early embryos, one with 10 early embryos, one with 8 well advanced embryos, 14 young.
- ,, 16. ,, 29, 30 and 35. Two clear, one dead. 31 young.
- ,, 17. ,, 26, 31 and 30. Another adult dead, one 3 with eggs, 31 young.
- ,, 18. ,, 26, 33 and 30. One with 3 embryos. Very numerous young.
- ,, 19. ,, 24, 30 and 31. Last adult dead. All but 5 young dead.

Experiment 18N. Reduced temperature. Set up July 28th. Three individuals of *S. serrulatus*, one with 8 embryos stage 2, one with 4 embryos stage 4, one clear.

June 28. Temperatures 12 and 14.

- ,, 29. ,, 14, 14. 4 young.
- ,, 30. ,, 14. One adult dead. 12 young.
- July 1. ,, 14 and 16. No change.
- ,, 2. ,, 14 and 14. No change.
- ,, 3. ,, 14 and 14. Adults dead. 12 young.

Experiment 1E. Reduced temperature. Set up July 17. Six individuals of *S. serrulatus*, one with 12 embryos stage 3, one with 3 embryos, two with 1 egg, two clear.

July 17. Temperatures 13 and 14.

- ,, 18. ,, 13, 13, and 14. No change.
- ,, 19. ,, 13, 13, and 14. 9 young.
- ,, 20. ,, 13, 13, and 13. One with 14 eggs. 8 young.
- ,, 21. ,, 13, 13, and 15. 3 young.
- ,, 22. ,, 13, 14, and 15. No change.
- ,, 23. ,, 15 and 13. No change.
- ,, 24. ,, 13, 12, and 13. No change.
- ,, 25. ,, 13, 13, and 13. 4 adults dead.
- ,, 26. ,, 13, 13, and 13. Adults and young dead.

Experiment 18V. At room temperature 16—20° C. Three individuals of *Ceriodaphnia reticulata*, each with 2 embryos stage 3. Set up July 14.

July 15. Embryos stage 4.

„ 16. „ stage 5.

„ 17. 6 young.

„ 18. No change.

„ 22. 3 adults, 9 young.

„ 23. No change.

„ 25. 3 adults. Numerous young.

„ 26. No change.

„ 30. One adult dead. Numerous young.

„ 31. Another adult dead. Numerous young.

Aug. 1. No change until Aug. 10th, when experiment was discontinued.

Experiment 18W. Raised temperature. Set up July 14. Two *Ceriodaphnia reticulata*, each with one egg; one with three embryos stage 5.

July 14. Temperature 30.

„ 15. „ 25, 29, and 29. 3 young.

„ 16. „ 29, 30, and 34. One with 2 embryos. One with 2 eggs. 12 young.

„ 17. „ 26, 31, and 30. One with 2 embryos stage 3. Other adults dead. 14 young.

„ 18. „ 26, 30, and 30. 14 young.

„ 19. „ 24, 30, and 30. One adult clear. 16 young.

„ 20. „ 29, 30, and 31. Adult dead, young nearly mature.

Experiment 6R. Reduced temperature. Set up July 29. One *Ceriodaphnia reticulata*, with 3 embryos stage 4; two with 2 eggs.

July 29. Temperature 13.

„ 30. „ 13, 13, and 14.

„ 31. „ 13, 14, and 15.

Aug. 1. „ 14, 14, and 14. 3 young.

„ 2. „ 14, 14, and 15.

„ 3. „ 14, 14, and 15. 5 young.

„ 4. „ 14, 14, and 14.

„ 5. „ 14, 14, and 14. Two adults dead.

„ 6. „ 14, 15, and 14. Last adult dead. 5 young.

Experiment 1M. Raised temperature. Set up July 24. Three individuals of *Scapholeberis mucronata*, one with 4 embryos stage 4, one with 3 embryos stage 2, one with 3 embryos stage 2.

July 24.	Temperature 31.	
„ 25.	„	25, 28, and 29. 6 young.
„ 26.	„	26, 29, and 31. 9 young.
„ 27.	„	30, 30, and 31. Adults with embryos. 9 young.
„ 28.	„	28, 28, and 30. 14 young.
„ 29.	„	29, 30, and 31. Numerous young.
„ 30.	„	29, 30, and 32. „ „
„ 31.	„	31, 31, and 32. One adult dead. Numerous young.
Aug. 1.	„	30, 31, and 34. Very numerous young.
„ 2.	„	27, 27, and 29. Another adult dead.
„ 3.	„	25, 27, nad 27. Last adult dead. Very numerous young, some almost mature.

Experiment 18K1. Reduced temperature. Set up July 3. Three individuals of *Scapholeberis mucronata*, one with 6 embryos, stage 3 one with 3 embryos stage 3, one clear.

July 4.	Temperature 14.	No change.
„ 5.	„	14 and 15. One adult with 3 eggs.
„ 6.	„	14 and 14. 9 young.
„ 7.	„	15 and 15. No change.
„ 8.	„	15 and 18. One adult dead.
July 9.	Temperature 14.	Another adult dead, 7 young dead.
„ 10.	„	14. No change.
„ 11.	„	12 and 12. Last adult dead. Two young.
„ 12.	„	13, 13, and 14. No change.
„ 13.	„	12, 12, and 12. No change.
„ 14.	„	12, 12, and 12. No change.
„ 15.	„	12, 12, and 12. Young nearly adult size.
„ 17.	„	12, 13, and 14. No change.
„ 18.	„	13, 13, and 14. No change.
„ 19.	„	13, 13, and 14. One young with 2 eggs.
	No change.
„ 26.	„	13, 13, and 13. Two adults, 2 young.
„ 27.	„	14, and 14. One adult and 1 young dead.
„ 28.	„	13, 13, and 12. One adult with 2 eggs.
„ 29.	„	13, 13, and 13. One young dead.
	No change.
Aug. 2.	„	13 and 14. One adult and 2 young.

Aug. 3.	„	14, 14, and 14.	One adult and one young dead.
.....No change.			
„ 10.	„	14, 14, and 14.	Young adult size.
„ 11.	„	14, 14, and 15.	One with ephippial egg.
.....No change.			
„ 16.	„	14 and 14.	Dead.

Experiment 2N. At room temperature, which varied from 16° to 22°C. Three individuals of *Scapholeberis mucronata*, one with 1 embryo stage 2, two with 2 embryos stage 4. Set up July 7.

July 8.	4 young.
„ 9.	5 young.
„ 10.	5 young.
„ 11.	10 young.
„ 12.	Adults with embryos. Several young.
„ 13.	Five now of adult size. Numerous smaller young.
„ 14.	No change.
„ 15.	No change.
„ 16.	Seven now of adult size. Numerous young.
„ 17.	7 adults, numerous young of various sizes.
„ 18.	7 adults, numerous young of various sizes.
„ 19.	7 adults, numerous young of various sizes.
„ 20.	Numerous adults, numerous young.
„ 21.	Numerous adults, numerous young, and this condition prevailed until July 31 when the experiment was discontinued.

Experiment 2M. Reduced temperature. One *Scapholeberis mucronata* with 2 embryos stage 4, two with 2 embryos stage 3. Set up July 7.

July 8.	Temperature 14, 14, and 14.	1 young.
„ 9.	„ 14, 14, and 14.	1 young.
„ 10.	„ 14, 16, and 13.	1 young.
„ 11.	„ 12, 12, and 13.	3 young.
„ 12.	„ 13, 13, and 13.	Two adults dead. 1 young.
„ 13.	„ 13, 12, and 12.	1 adult, 1 young.
„ 14.	„ 12, 12, and 12.	1 adult, with eggs. 1 young.
„ 15.	„ 12, 13, and 12.	1 adult, 1 young.
„ 16.	„ 12, 13, and 14.	1 adult, 1 young.
„ 17.	„ 12, 13, and 13.	1 adult, 1 young, nearly adult size.
„ 18.	„ 13, 13, and 14.	1 adult, 1 young, nearly adult size.

July 19.	„	13, 14, and 14.	2 adults.
„ 20.	„	13, 13, and 14.	No change, experiment discontinued.

Experiment 2P1. Raised temperature. One *Scapholeberis mucronata* with 1 embryo stage 5, one with 1 embryo stage 3, one with 7 embryos stage 2. Set up July 9.

July 10.	Temperature	27, 30, and 30.	1 young.
„ 11.	„	26, 26, and 27.	2 young.
„ 12.	„	27, 30, and 30.	9 young.
„ 13.	„	30, 30, and 30.	Numerous young.
„ 14.	„	42—All dead.	

The results of these experiments, and of many others of a similar nature which are not reported in detail, indicate that in these three species of cladocerans a high temperature, i.e., 25—34°C, materially increases the rate of parthenogenetic reproduction, that a low temperature, i.e., 12—14°C, retards this process. It would appear, however, from the “room temperature” experiments reported, and from many others, that on the whole a temperature of from 16° to 22°C is most favourable for these species, as while the rate of reproduction is not so rapid, the adults live longer, and produce, in the aggregate, more young. That the thermal death-point of these cladocerans is between 34° and 42°C was shown, inadvertently, by the temperature of the water-bath running up to this latter temperature (due to a variation in gas-pressure) during one night, and thus killing all the individuals of several cultures of all three species. Warren (1900) found the thermal death-point of *Daphnia magna* to be 38. 25°C.

The effect of temperature on the rate of growth of the Ostracod *Cyprinotus incongruens* is shown very clearly by the results of four experiments which were carried out on the effect of light, two of these experiments being made with the animals in vials in the sea, and two in vials in a glass container full of water in an open place on land. The temperature in a former case varied from only 12° to 13°C and in the latter from 7°—12° at night and from 17° to 31°C during the day. Forty animals were used in each case, and the average growth rate per individual during one week was 407 μ in the case of the lower temperature and 1105 μ in the case of the higher temperature.

THE EFFECT OF INCREASED SALT CONCENTRATION

The experiments on the effect of an increase in the salt concentration were carried out in three ways—

1. The animals were placed in culture media in which the salt concentration was $1\frac{1}{2}$, 2, and 4 times as strong as that in which the controls were carried.
2. The animals were placed in water from the original habitat which had been reduced to $1/2$, $1/4$, $1/8$, $1/16$ and $1/32$ the volume respectively by boiling, and then aerated after cooling.
3. The animals were placed in pool water reduced to $1/2$ the volume, and then transferred, every forty-eight hours, to the next highest concentration, viz., pool water reduced to $1/4$, $1/6$, $1/8$, $1/12$, $1/16$, $1/20$ and $1/32$.

Experiments in which 1 and 2 were combined with a high temperature and a low temperature were also carried out.

These experiments will be reported in detail only in the cases in which the results are of special interest.

Exp. 18D. Three *S. mucronata*, with respectively 5 eggs, 3 eggs and clear, placed in culture solution $1\frac{1}{2}$ concentration on June 26. Carried until July 22nd, when there were 9 adults and 21 young, of various sizes. None ephippial.

Exp. 1W. One *S. mucronata*, clear, in culture solution twice concentration. Set up Aug. 8. Carried to Aug. 16, when dead with 4 embryos stage 4.

Exp. 6F. Three *Ceriodaphnia reticulata*, one with 1 embryo stage 1; two clear. Placed in culture solution of twice the concentration on July 28. One dead with 2 eggs on July 31. One dead with 1 embryo on Aug. 1. One adult, clear, and 1 young, dead on Aug. 5.

Exp. 18U. Six *S. mucronata*, one with 4 eggs, rest clear, placed in culture solution of twice the concentration on July 15. All adults alive and numerous young on July 29. Some young of adult size on Aug. 1, 4 with ephippia on Aug. 2, and another on Aug. 12. Five shed ephippia and 9 ephippial individuals on Aug. 17. Only 3 alive on Aug. 24. Last dead on Aug. 29. 14 shed ephippia present.

Exp. 2K. Three *Simocephalus serrulatus*, 1 with 2 embryos, 2 clear, placed in culture solution of twice concentration on July 4th. Condensed data as follows—

July 12. One adult with 1 egg; 2 clear; 1 young.

„ 14. One adult with ephippium; 1 with 1 egg; 1 clear; 1 young.

„ 17. 1 adult with ephippium, 1 with 1 egg, 1 with 1 embryo; 1 young; 1 shed ephippium.

- July 24. 1 „ 6 young.
 „ 25. 1 „ 6 „
 „ 26. 1 „ 6 „
 „ 27. 1 „ 5 „
 „ 28. 6 individuals.
 „ 29. 6 „
 „ 30. 6 „
 „ 31. 4 adults, 9 young.
 Aug. 1. 3 adults, 9 young.
 „ 2. 2 „ 5 „
 „ 3. 2 „ 5 „
 „ 4. 2 „ 5 „
 „ 5. 2 „ 5 „
 „ 6. 2 „ 5 „
 „ 7. 7 individuals.
 „ 8. 4 adults, 5 young.
 „ 9. 3 „ 3 „
 „ 10. 2 „ 2 „
 „ 11. 2 „ 1 „
 „ 12. 2 „ 1 „
 „ 13. 2 „ 1 „
 „ 14. 2 „ 1 large and 3 small young.
 „ 15. 2 „ 4 young.
 „ 16. 2 „ 4 „
 „ 17. 2 „ 4 „
 „ 18. 2 „ several young.
 „ 19. 2 „ „ „
 „ 20. 2 „ „ „
 „ 21. 2 „ „ „
 „ 22. 2 „ „ „
- Exp. 6a. Six *S. mucronata* placed in pool water twice concentrated (pool 2) on July 7.
- July 8. No change.
 „ 9. Several young.
 „ 10. 4 adults, 4 young. [4 adults transferred to pool 4 (Exp. 6A1) 4 young to 6AB.]
 „ 11. (6A1) 4 adults and numerous young.
 „ 12. „ 3 „ „ „ „
 „ 13. „ 3 „ „ „ „ „
 „ 13. Three young transferred to pool 6 (Exp. 6A1B). Others to other experiments.

- July 14. (6A1B). Three young.
 „ 15. „ 2 young.
 „ 16. „ 2 „
 „ 17. Transferred to pool 8.
 „ 18. 2 young.
 „ 19. 2 young. Transferred to pool 12.
 „ 20. 2 individuals.
 „ 21. 2 adults, 6 young. Transferred to pool 16.
 „ 22. 2 „ 6 „
 „ 23. 2 „ 6 „ (1 adult and 1 jv. to 6A1B1).
 „ 24. 1 adult, 5 young.
 „ 25. 5 individuals.
 „ 26. 3 with ephippia, 2 with eggs.
 „ 27. 3 with ephippia, 2 with eggs.
 „ 28. 1 with ephippium, 3 shed ephippia.
 „ 29. 5 adults, 1 with ephippium.
 „ 30. 5 adults.
 „ 31. 5 adults, 2 with ephippia, 4 shed ephippia.
 Aug. 1. 4 adults, 2 with ephippia, 5 shed ephippia.
 „ 2. 4 adults, 2 with ephippia, 2 young.
 „ 3. 4 „ 2 „ „ 2 „
 „ 4. 3 „ 2 „ „ 2 „
 „ 5. 3 „ 2 „ „ 6 shed ephippia. 2 young.
 „ 6. 2 „ each with ephippium, 6 shed ephippia.
 „ 7. 2 „ „ „ „ 6 shed „
 „ 8. 1 „ 7 shed ephippia. 2 young.
 „ 9. 3 individuals.
 „ 10. 2 adults, 1 with ephippium.
 „ 11. 2 adults, 8 shed ephippia.
 „ 12-13. No change.
 „ 14. 2 adults, 1 with 1 embryo.
 „ 15. 1 adult.
 „ 16-21. No change.
 „ 22. Dead.

In the other experiments of this series may be summarized as follows—

Pool 12 (i.e. concentrated to 1/12). Ephippia were produced in 3 cases and not produced in 1 case.

Pool 16. Ephippia were produced in 4 cases and not produced in 2 cases.

Pool 20. Ephippia were produced in 2 cases.

The animals usually died in a few days in pool 20, and always died within four days in pool 32.

The results of the experiments by these three methods indicates that an increase in salt concentration induces the ephippial condition. In the case of those experiments in which the animals were left for a long time in the same culture solution before ephippia were produced I am inclined to discount the salt concentration factor as the causative agent, as in these cases it is just as likely that certain excretory products may have been the real agents, but in case of the third method, in which the animals were transferred frequently to fresh solutions the possibility of influence of excretory products is completely eliminated. It is difficult to find an explanation for the formation of ephippia at low temperature rather than at higher temperatures, as this is exactly the opposite of the condition which prevails in the spring pools when they are drying up and when, as repeated field observations testify, ephippia are produced in large numbers.

The tendency of old cultures, especially those in which the population has increased rapidly by parthenogenetic reproduction, to become ephippial has been noted by several authors, Grosvenor and Smith (*op. cit.*), Langerhans (1909), Smith (1915), and the suggestion has been made that certain excretory products are the causative factor. As I made no experiments directly aimed at confirming or refuting this idea I shall mention here that in four cases cultures of this character became ephippial, and furthermore that when fresh animals, direct from their natural habitat, were introduced into these old culture solutions they died within 12 to 14 hours. This very limited data would point to certain toxic substances as a causative agent of the sexual condition in cladocerans, but as to the actual existence of these substances, and as to what is the nature of these substances, are questions which, like many other matters in entomostracan metabolism, must be left for future biochemical investigations to solve.

THE EFFECT OF HYDROGEN ION CONCENTRATION

In the somewhat extensive literature which has grown up in recent years concerning the influence of Hydrogen ion concentration upon various organisms there is, as far as I know, but one paper (Reed and Klugh, 1924) in which entomostracans are mentioned. There is no question, however, but that this factor is of great importance not only because it probably controls to a certain extent the distribution of many species, but because it appears that the tolerance of a species to a wide

range of pH indicates a tolerance to a fairly wide range of other environmental factors, which is a matter of prime importance from the cultural standpoint.

In these experiments the "steps" in the Hydrogen ion concentration were not made very close, as even if adjustment was made to 2/10 of a pH unit at the beginning of an experiment, it would be impossible to hold it to this throughout the experiment as the respiration of the animals, the decomposition products from the organic detritus which was put in as food, and other chemical changes, cause a change in the pH which would very quickly swing it more than 2/10 of a unit. In all cases pH readings (colorometric) were made at the conclusion of the experiment in order to ascertain if the pH had really been, throughout the experiment, within the range it was supposed to be. In these experiments dried organic detritus was placed in the vials as food, instead of algae, because obviously the photosynthesis of living algae would bring about a rapid change in the pH. The use of soft glass, such as that of which vials are made, is open to objection, when close readings of pH are to be made, because of the solubility of the glass, but in this case, where readings were only to a whole unit, it is not a source of serious error.

No discussion of the value of detritus as food will be entered upon here, as this matter will be taken up under the heading of "food relations." In one case (Exp. FF), however, the experiment had to be re-set with algae as food, because the animals died when supplied with detritus only.

In each case three animals were used, and they were placed in solutions of pH 4, 5, 6, 7, 8, 9, and 10, respectively, the pH being adjusted in all cases by the use of NaOH and HCl, so that the possible influence of different salts was avoided.

Experiment AA.		pH Range of <i>Cyclops fuscus</i> .							
	18.	19.	20.	21.	22.	23.	24.	25.	
pH4	3	Dead.							
pH5	3	3	3	3	3	3	2	2	
pH6	3	3	3	3	3	3	2	2	
pH7	3	3	3	3	3	3	2	2	
pH8	3	Dead.							
pH9	3	Dead.							
pH10	3	Dead.							

Experiment BB.		pH Range of <i>Cyprinotus incongruens</i> .							
Aug.	18.	19.	20.	21.	22.	23.	24.	25.	
pH4	3	3	Dead.						
pH5	3	3	3	3	3	3	Dead.		
pH6	3	3	3	3	3	3	2	2	
pH7	3	3	3	3	3	3	3	3	
pH8	3	3	3	3	3	3	3	3	
pH9	3	3	3	3	3	2	1	Dead.	
pH10	3	Dead.							

Experiment CC.		pH Range of <i>Simocephalus serrulatus</i> .							
Aug.	18.	19.	20.	21.	22.	23.	24.	25.	
pH4	3	Dead.							
pH5	3		3	3	Dead.				
pH6-5	3		3	3	3	3	3	3	
pH7	3	3	2	2	2	Dead.			
pH8	3		3	3	Dead.				
pH9	3	Dead.							
pH10	3	Dead.							

Experiment EE.		pH Range of <i>Cypria exculpta</i> .							
Aug.	18.	19.	20.	21.	22.	23.	24.	25.	
pH4	3	Dead.							
pH5	3	3	3	3	3	2	1	Dead.	
pH6	3	3	3	3	3	3	3	3	
pH7	3	3	3	3	3	3	3	3	
pH8	3	3	3	3	3	3	3	2	
pH9	3	2	2	2	2	1	1	Dead.	
pH10	3	1	1	1	1	1	1	Dead.	

Experiment FF.		pH Range of <i>Alona costata</i> .									
Aug.	18.	19.	20.	21.	22.	23.	24.	25.	26.	27.	
pH4	3	Dead.									
pH5	3	3	Dead.	Re-set	Dead.						
pH6	3	1	Dead.		Dead.						
pH7	3	Dead.		with	3	3	3	3	3	Dead.	
pH8	3	Dead.			3	3	3	Dead.			
pH9	3	Dead.		Algae	3	Dead.					
pH10	3	Dead.			Dead.						

In considering the results of these experiments it must be borne in mind that these entomostracans were all inhabitants of pools in a sandstone and granite region where all the waters have a pH which

is less than 7.2, and that some of them were inhabitants of bog pools in which the water was decidedly on the acid side. Unfortunately no entomostracans from a limestone region were available for experimentation, as it would have been interesting to see if their range of tolerance was not more on the alkaline side. Finally I should state that I regard these merely as initial experiments, which should be repeated many times before definite conclusions are drawn.

THE EFFECT OF LIGHT

The effect of light on entomostraca has been considered almost exclusively from the standpoint of the reactions of these animals to phototactic stimuli, and in regard to this matter there is a considerable amount of data (v. Bert, 1869; Lubbock, 1881; Merejkowsky, 1881; Birge, 1897; Davenport and Lewis, 1899; Yerkes, 1899 and 1900; Fordyce, 1901; Parker, 1901; Radl, 1901; Juday, 1903; Esterly, 1907; Ostwald, 1907; Franz, 1910; Mast, 1911; Ruttner, 1914; and Banta, 1921). Little seems to have been done on the influence of light on general metabolism, growth, feeding, or the life-cycle. McClendon (op. cit.) mentions an experiment, in which cultures were kept in the dark, in weak light and in sunshine, which gave negative results. Warren (1900) found that 5 individuals of *Daphnia magna* made slightly greater growth and produced many more young under a ground glass and in red light than in green or blue light or in darkness. His light-conditions were, however, so poorly controlled that little reliance can be placed on his data for red, green and blue light, as the intensities of the green and blue were apparently very low, while that of the red may have been high. Light affects entomostracans, directly or indirectly, in many ways. The amount of light received by a small body of water or by the different parts of a large body of water determines to a very large extent the quantity and the composition of the flora, and this in turn affects the entomostracans in at least two ways—it influences the food supply, both as to algae and organic detritus, and also the amount of shelter. It affects the activity, and hence the amount of food taken, in the case of many species. It plays a part in controlling the bacteria which may possibly be pathogenic for entomostracans. It influences—phototactically—the vertical distribution of entomostracans, and hence the layers of water with a greater or less ample food-supply, into which they are brought. It is possible that light, and especially the shorter wave-lengths, may have a direct lethal effect on some fresh-water entomostracans, as has been shown by Huntsman (1924) for certain marine copepods.

As no method of obtaining exact quantitative data on the light factor of ecological habitats had been developed, an instrument was designed and constructed for this purpose. This instrument, which is described elsewhere (Klugh, 1925), was not ready for use until late in the season of 1924, so that very little data has so far been obtained with it. It was found, however, that in a pool constructed in the open where it received full sunshine, *Cyprinotus incongruens* thrived, while in a pool constructed in the woods, where the light value on sunny days was but 2%, and on cloudy days 10%, of the light in the open, it died out. *Cyclops fuscus*, on the other hand, lived in both pools, but did best in the shaded pool.

Four experiments were carried out, with the co-operation of J. Russel Martin, to ascertain the effect of light intensity on the effect of light of different wave-lengths on the growth-rate of *C. incongruens*. These experiments were carried out as follows:—

In all cases the experimental animals were placed in shell vials in water from their habitat, together with detritus from their habitat and a measured quantity of a pure culture of a palmella alga, as food. There was at all times an abundance of food, so that a difference in the quantity of food available was not a factor in accelerating or retarding the growth rate. The temperature was exactly the same for all the animals of a given series. This was brought about in the case of the four series on intensity by arranging the vials in such a manner that they floated at the surface of the same body or vessel of water, and in the case of the series on the effect of wave length by having the "colour-boxes" side by side and constantly checking by a thermometer. The only variable in these experiments, therefore, was light.

In these experiments on the intensity of light the intensity was controlled in the following manner. Pieces of photographic film were exposed to a weak light for various brief periods, then developed, fixed and dried. These were then matched, visually, against a set of neutral filters of known transmission, and the pieces which matched the filters having the desired transmission were selected. This method of obtaining neutral transmission filters is, of course, by no means as accurate as the use of a standard photometric instrument, but as a large number of films differing in density from one another by very small steps, were prepared to select from, and as the set of filters of known transmission, against which these were matched, differed from each other in steps of ten per cent., it is believed that the error in the transmission of the filters prepared in this manner is not greater than five per cent. That is, the intensity given as

fifty per cent.; certainly it was not as low as forty per cent. or as high as sixty per cent.

In the case of the experiment on the effect of light of different wave-lengths the spectrum was divided into three regions by the use of Wratten filters Nos. 26, 58 and 47. The red filter No. 26, has a total transmission of twenty-two per cent. and a transmission greater than ten per cent. only from w. l. 690μ downwards. The green filter, No. 58, has a total transmission of twenty-three per cent. and a transmission above ten per cent. only from 580μ to 490μ . The blue filter, No. 47, has a total transmission of 2.9 per cent., and a transmission greater than ten per cent. only from w.l. 500μ upwards. The spectrophotometric curves, and full transmission data on these filters are given in "Wratten Light Filters" issued by the Eastman Kodak Company. All the filters were brought to very nearly the same total transmission value, i.e., a close approximation to 2.9 per cent., by placing a prepared film filter of approximately 12.5 per cent. behind the red and green filters in the colour-boxes, those neutral filters being selected whose density fell between that of the ten per cent. and fifteen per cent. filters of the set of known transmission.

In each experiment a sufficiently large number of animals was used to eliminate errors due to individual variations in growth rate. Each animal was measured with a micrometer eyepiece, the length being recorded in micra, at the beginning of the experiment, and again at its conclusion a week later.

In the case of the intensity experiments the corks of the vials were sealed over with paraffin, and each vial was placed in a larger vial, which had a piece of cork at the bottom to cut off light from this direction. The vial in which the animals were to be exposed to full light was simply placed in a larger vial, which was sealed with paraffin. The vial in which the ostracods were to be exposed to an intensity of fifty per cent. light had the fifty per cent. transmission film placed between it and the larger vial, the vial in which the animals were to be exposed to an intensity of twenty per cent. had a twenty per cent. film placed between it and the larger vial, while the vial for total darkness was wrapped in black paper and then in white paper before it was placed in the larger vial. The white paper outside the black for the "darkness vial" was used to prevent a possible rise in temperature due to absorption of heat by the black paper, and that the rise in temperature was no greater when exposed to full sunlight than in the other vials was proved before the beginning of the experiments.

In the experiments on the effect of light of different wave-lengths the vials were placed in small boxes, with a light-tight sliding door at the back, and the filters forming the whole front of the box. These "colour boxes" were placed close to the glass in an east window.

Effect of Light Intensity. Experiment No. 1. This experiment was set up on June 24. The vials were arranged on a board which was fixed to a floating breakwater in the St. Croix River so that they were just beneath the surface of the water. The lengths of the animals (averages of 10) were as follows, all measurements being in micra:—

Full light 925.6. Fifty per cent. light 901.5. Twenty per cent. light 911.3. Darkness 602.1.

When read on July 1 the measurements were as follows:—

Full light 1115.1. Fifty per cent. light 1066. Twenty per cent. light 1154.5. Darkness 895.4.

The average increase per animal was:—

Full light 189.1. Fifty per cent. light 154.5. Twenty per cent. light 92. Darkness 57.3.

Effect of Light Intensity. Experiment No. 2. This experiment was carried out in the same way as experiment No. 1. The experiment was begun on July 22 when the measurements were as follows:—

Full light 379.4. Fifty per cent. light 369.1. Twenty per cent. light 349.0. Darkness 362.4.

On July 29 the measurements of the animals were as follows:—

Full light 597.7. Fifty per cent. light 634.4. Twenty per cent. light 590.9. Darkness 449.4.

The average increase per animal was:—

Full light 218.3. Fifty per cent. light 265.3. Twenty per cent. light 241.9. Darkness 87.0.

Effect of Light Intensity. Experiment No. 3. This experiment was performed in the same way as experiment No. 1 except for the following modifications: the boards supporting the vials were placed in large glass jars which were kept filled with water and were placed in an open situation; a sinker was attached to each board to hold the vials about one centimeter below the surface of the water; and the experiment with the intensity of the light at twenty per cent. was omitted. Six vials were used each containing ten animals. On July 21 the measurements of the animals were as follows:—

Full light 362.05. Fifty per cent. light 377. Darkness 306.2.

On July 28 the average lengths of the animals were as follows:—

Full light 977.05. Fifty per cent. light 962. Darkness 519.6.

The average increase per animal was as follows:—

Full light 615. Fifty per cent. light 585. Darkness 213.4.

Effect of Light Intensity. Experiment No. 4. This experiment was a repetition of experiment No. 3. The experiment was begun on July 29 and on that date the measurements of the animals were as follows:—

Full light 512.2. Fifty per cent. light 576.4. Darkness 545.7.

On August 5 the average lengths of the animals were as follows:—

Full light 903.1. Fifty per cent. light 1048.9. Darkness 677.3.

The average increase per animal was as follows:—

Full light 490.9. Fifty per cent. light 472.5. Darkness 131.6.

Effect of Light of Different Wave-lengths. The details of the procedure of this experiment are described above. On July 21, when the experiment was begun, the measurements of the lengths of the animals were as follows:—

Red 373.1. Green 376.3. Blue 368.

On July 28 the average lengths of the animals were as follows:—

Red 456.5. Green 548.8. Blue 573.9.

The average increase per animal was as follows:—

Red 83.4. Green 180.7. Blue 205.9.

A probable explanation for the more rapid rate of growth in full light and in fifty per cent. light than in the dark is that the animals are more active in light than in the dark and as a result of their activity they spend more time in feeding. The greater activity of *C. incongruens* in light of high intensity was proved experimentally. The higher mortality which was found in the case of the animals in the dark may possibly be associated with bacterial infection, as Dr. Guilford Reed, who kindly examined the contents of a vial which had been in the dark and in which the mortality had been high and of that of a vial which had been in full light, reported a heavy infection of bacteria of *B. coli* type in the former vial and no bacteria of this type in the latter. The greater growth in the blue region of the spectrum may likewise be associated with greater activity, as the animals appeared to be more active in blue light than in red.

One experiment on the effect of light intensity on the growth-rate of *Scapholeberis mucronata* was carried out, the method being the same as employed for *Cyprinotus*, with the exception that only five young, 338 μ in length, were used at each intensity. In this experiment the average increments per animal per week were as follows:—

100 per cent.—185.

50 per cent.—154.

Darkness— 61.

Two other experiments of the same nature with this species were failures because of the death of all the animals in darkness.

The reasons for the greater growth in the light in this species, and for the high mortality in the dark, are probably the same as for *Cyprinotus*. That *S. mucronata* is far more active in light than in darkness or in an extremely dim light was proved by many observations.

THE EFFECT OF PHOTOPERIODISM

The effect of the relative length of day and night upon the metabolism of plants has been considered by several authors, as MacDougal (1903), Tournais (1912), and especially Garner and Allard (1920) who suggested the name photoperiodism for this phenomenon. Recently Marcovitch (1924) has shown that the appearance of the sexual forms of several species of *Aphis* is controlled by photoperiodism.

Four experiments with *Simocephalus serrulatus* and two with *Scapholeberis mucronata* were carried out to test the effect of photoperiodism, the experimental animals being exposed to north light for only six hours per day (12 noon to 6 p.m. in July), while the controls were in north light for the whole period of daylight. No effect on the production of ephippia was found, as none were produced in either the experimental animals or the controls, and the only difference was that the animals exposed to light throughout the day lived longer and produced more young than those which received but six hours light.

It cannot be assumed from these negative results that photoperiodism does not play a part in the onset of sexuality in any cladocerans, as the animals experimented on were both from pools, and there is a possibility that this factor may be effective in the case of planctonic species which produce ephippia in the largest numbers when the days are rapidly growing shorter.

ENEMIES

The chief enemies of entomostracans are, as far as I have been able to determine, fish, dragonfly nymphs and Hydra. The role of fish as enemies is sufficiently demonstrated by the data given at the beginning of this paper, and, moreover, as we are here concerned with the raising of entomostracans as food for fish, we regard as enemies, in the practical sense, only those animals which compete with the particular species of fish we wish to benefit by the supply of entomostracans provided.

Dragonfly nymphs feed voraciously upon entomostracans. I have seen a nymph of *Aeschna umbrosa* snap up six *Simocephalus serrulatus* in a minute, though in this case, it is true, the nymph had not been fed since the previous day. From observations in the field I am inclined to think that in many habitats the chief food of dragonfly nymphs consists of entomostracans.

Hydra viridissima, *H. oligactis* and *H. vulgaris* seem to feed almost exclusively on entomostracans. Repeated observations, both in the field and laboratory, tend to confirm this statement. I have seen a specimen of *H. oligactis* with five specimens of *Cyprinotus incongruens* in its gastro-vascular cavity at one time.

While the above-mentioned animals are apparently the chief enemies of entomostracans there are several other animals which feed on these minute crustaceans to a greater or less extent, and concerning three of these I secured positive data.

I had noticed on several occasions that when tadpoles of *Rana clamitans* and *Rana sylvatica* became abundant in a pool the number of cladocerans decreased. Furthermore, I felt fairly certain that I had, while watching the animals in their natural habitat, seen a tadpole eat a cladoceran, but exact observation on this matter was practically impossible in the field. In order to make certain, experiments were made in the laboratory. First four tadpoles of *Rana sylvatica* were dissected and the contents of their alimentary tracts examined, with entirely negative results as far as entomostracan remains were concerned. On June 26 six specimens of *Simocephalus serrulatus* were placed in a vessel with two tadpoles of *R. sylvatica* and with algae as food for the latter. The tadpoles were watched closely for two hours and seemed to pay no attention to the cladocerans. On June 28 all the cladocerans had disappeared and on dissecting the tadpoles three of the cladocerans were found in their intestinal tracts. This proved that the cladocerans had been eaten either purposely, or accidentally along with the algae. On June 29 six *S. serrulatus* were placed in a vessel with two tadpoles, of the same species, and with no algae. On June 30 only one cladoceran remained. Here, again, the eating might have been accidental as the tadpoles might have taken the cladocerans along with the algal cells which were present in their excrement and which they were seen to re-ingest. On June 28 six tadpoles were put in filtered pool water with no food. The water was changed on June 29 and again on June 30, so that all excrement was removed, and as no food had been taken no more intestinal contents remained to be excreted. On June 30 six *S. serrulatus* were placed in a vessel with three of these tadpoles, and

six in another vessel with the three other tadpoles. On July 1 all the cladocerans had disappeared from the first vessel and only one remained in the second. On July 2 the last cladoceran had disappeared. Examination of the contents of the alimentary tracts of three of these tadpoles showed remains of cladocerans. This conclusively proved that tadpoles of *R. sylvatica*, while they undoubtedly feed chiefly on algae, do sometimes purposely take cladocerans.

Another animal which was proved to be an enemy of entomostracans was the larva of *Corethra*. Larvae of a species of this genus which were obtained from Bocabec Lake, and kept in vessels in the laboratory for three weeks, were repeatedly seen to seize and devour specimens of *Cyclops fuscus*, *Simocephalus serrulatus*, and *Ceriodaphnia reticulata*. Baird (1850 p. 7) and Birge (1897 p. 311) mention *Corethra* as an enemy. Young larvae of *Dytiscus* feed voraciously on entomostracans but larger larvae pay no attention to them.

Animals which were experimented with to see if they might possibly be enemies of entomostracans, but which proved to be entirely innocent in this respect, were *Ranatra fusca*, *Notonecta undulata*, and *Gerris remigis*.

Among the enemies of entomostracans must be reckoned certain other entomostracans, as *Leptodora kindtii* (Birge, 1897, p. 351) feeds largely on smaller cladocerans and I have repeatedly seen large *Cyclops fuscus* seize and devour small specimens of its own species.

FOOD-RELATIONS

The earlier writers on Entomostraca are extremely vague in their statements as to the food of these animals. Müller (1785) states that they live on vegetable matter. Jurine (1820) says that *Cyclops* is carnivorous and that *Daphnia* feeds on animalcules, Schaeffer, as quoted in the translation in Jurine (op. cit), refers to the food of entomostracans as "insectes." Straus (1821) gives vegetable matter as their diet. Baird (1850 p. 6) says that they are carnivorous and feed on animalcules, and Ryder (1881) makes the same statement. Kochs (1892) says "Von dem richtigen Gedanken ausgehend, dass die kleinen Kruster von Infusorien leben."

A considerable number of more recent authors infer from the occurrence of certain species of entomostracans in waters in which algae are abundant that these animals feed on green algae, and "pools rich in algae" is a common phrase in describing the habitat of a species. Thus Schacht (1897) says of *Diaptomus stagnalis*, "The pool in which they were taken was particularly rich in decaying vegetable matter.

It literally swarmed with Volvox. The food-supply was practically inexhaustible and the specimens taken were unusually large."

Fordyce (1901) speaks of "an abundant growth of Cladoceran food in the form of infusoria and algae of several varieties." Birge (1897) has given the best account of the food of entomostracans, as observed in their natural habitat, with which I am familiar. He states (p. 353) that three species of *Daphnia* eat *Aphanizemonon* with avidity, also filamentous diatoms, including *Fragillaria*, *Melosira*, and *Diatoma*, and (p. 355) that *Cyclops* is carnivorous, devouring rotifers, nauplii, and other animals as well as plants. He mentions *Cyclops* as feeding also on *Ceratium*, but that this hard-shelled flagellate is not eaten by *Daphnia*, nor to any large extent by *Diaptomus*, which feeds mainly on *Anabaena* and *Aphanizemonon*. His statement (p. 353), "since these preferences for various kinds of food are so strikingly marked" is especially worthy of note, as it is often assumed that there is little or no choice in the matter of food among entomostracans.

Vavra (1891) says of the Ostracoda, "Zur Nahrung dienen den meisten Arten vorzüglich die Leichen verschiedener Wasser—und anderer Thiere, an denen sie sich massenhaft anzusammeln pflegen. Eine geringere Anzahl von Arten sucht vegetabilische Nahrung auf und ich fand in dem Verdauungskanal derselben oft die Schalen von Diatomaceen and Algenreste überhaupt."

Apstein (1896), on the basis of examination of contents of their alimentary tracts, states that *Bosmina*, *Daphnia* and *Diaptomus* feed on *Melosira*.

Woltereck (1908) says, "Zwar kann man auch mit Kulturen von *Scenedesmus*, *Rhaphidium*, u.s.w. die pelagischen Daphnien ernähren, aber viel besser gedeihen sie bei Fütterung mit kleinsten Palmellaceen, *Chlorella*, u. dgl."

McClendon (op. cit) says, "I had in the laboratory a pure culture of a unicellular green alga which the daphnids ate readily."

Scharfenberg (1914), speaking of *Scenedesmus*, says, "Es hat sich wieder als ein ganz besonders gutes Futter für Cladoceren bewährt."

Dodds (1915) says, "The Entomostraca feed almost exclusively upon microscopic plant forms which are abundant in all waters."

Smith (1915) states that they feed on "Green Algae such as *Protooccus*."

Birge (1918) says that the food of the Cladocera "consists largely of algae, though nothing edible is rejected that the current brings in," which seems somewhat at variance with his statement (1897, p. 353) as to selection of food.

Moore (1920) records *Bosmina* feeding on the antherozoids of *Volvox*, and *Scapholeberis* having in the digestive tract "a miscellaneous diet of unicellular and palmelloid algae."

Moore (1922, p. 61), speaking of *Cyclotella*, says, "It occurs throughout the summer as the dominant plankton alga in the food canal of the three most common species of water-fleas."

Green (op. cit) raised his experimental *Simocephalus vetulus* by placing a single female, with eggs or embryos in the brood pouch, in a three gallon aquarium in which a growth of green algae had been obtained by stocking the jar with algae, inserting two or three frogs, and keeping the jar covered to insure the maintenance of a high percentage of CO₂ and the depletion of oxygen. He states that the daphnids "did not thrive on algae artificially produced," that is, by the use of culture solutions, but that the animals did well on algae produced as above.

Reviewing the literature which has so far been cited we see that the food of all the entomostracans mentioned is given as consisting of living organisms—either plant or animal—with the exception of some ostracods which are said to feed on dead animal matter. The organisms which are listed as entomostracan food may be divided into groups as follows:—(1) Protozoa. No data as to species eaten, or as to whether any protozoan is actually eaten. (2) *Diatoms*. The genera *Melosira*, *Cyclotella*, *Fragillaria* and *Diatoma* found in alimentary tracts. (3) Flagellata. *Volvox* suggested because of its abundance in the habitat; *Ceratium* seen to be eaten. (4) Cyanophyceae. *Aphanizomenon* and *Anabaena* mentioned. (5) Chlorophyceae. "Unicellular green algae" mentioned but no generic or specific determinations except *Scenedesmus*, and *Volvox*. (6) Other entomostracans. Given as eaten by *Leptodora* and *Cyclops*.

We now turn to two other kinds of foods which have been suggested as furnishing nutrition for entomostracans—organic substances in solution and organic detritus. Suggestions that organic substances in solution may play a part in the nutrition of entomostracans, especially of *Daphnia pulex*, are found in the earlier literature in which it is noted that certain entomostracans are abundant in pools which contain a large amount of these substances in solution, as in the case of barn-yard pools. Such observations, of course, convey no precise information as to the exact nature of the food, as in these cases it *might* be the dissolved substances, or it might be detritus which gathers in such places, or it *might* be algae, or other organisms which are nourished by the dissolved substances.

The first experimental evidence on the rôle of organic sediment and dissolved organic substances in the nutrition of entomostracans was furnished by Knörrich (1900), who placed a group of ten daphnids in an unfiltered straw-infusion and another group of ten in a filtered straw-infusion, the experiment running for ten days, and the infusion being changed daily in the latter case. From these experiments he concludes that "die organische tote Substanz, sedimentär oder gelöst, von den Krustaceen all Nahrungsmittel erfolgreich verwertet worden ist," and that, "gelöste organische Substanzen von den Krebstierchen sowohl aufgenommen als auch verwertet werden."

Pütter (1908, 1909, 1911) included the entomostracans among the animals which derived a considerable amount of their nutriment from the organic substances dissolved in water. Wolff (1904) says, "für *Simocephalus retulus* die Püttersche Theorie sich vollkommen zutreffend erwiesen hat."

Pütter's methods and conclusions have been called into question by several investigators, as Lohman (1910), Kerb (1910), and Lipschütz (1913). Kerb found that daphnids lost weight in an organic solution. Lipschütz' results from investigations on fish, actinians and ascidians, entirely contradict the conclusions of Pütter in regard to the use of dissolved substances by these animals, and in regard to cladocerans, Lipschütz, after reviewing the work of Wolff and Kerb, says, "Man kann auch für die Krustaceen die Frage nach der Möglichkeit einer Aufnahme gelöster organischer Stoff aus dem natürlichen Medium nicht bejahend beantworten."

Kuttner (1909) says, "Als Futter verwendete ich bei *Moina paradoxa* Weizenmehl, bei übrigen Arten einen Brei von pflanzlichen Detritus, den ich erhielt, indem Wasserpflanzen, hauptsächlich Elodea, mit einem Holzlöffel durch ein feines Drahsieb presste."

Naumann (1918 and 1920), as a result of a study of the filtration apparatus and an examination of the contents of the alimentary tracts of cladocerans, comes to the conclusion that "staubfeine Detritus" plays the chief part in the nutrition of cladocerans of the "filtrierenden Typus," and that the algae other than *Chlamydomonas* are not digested. Naumann (1923), discussing the feeding of copepods, shows that *Cyclops leuckartii* and *Heterocope appendiculata* mainly "als Raubtiere arbeiten," *Diaptomus gracilis* "gehört dem Typus der nicht wählerisch arbeitenden Fein—und Grob-Filtratoren an," and that nauplii exhibit "der schwach wählerisch arbeitenden Feinfiltratoren."

My investigations on the food-relations of Entomostraca fall under three headings:—

1. Examinations of the contents of the alimentary tracts of numerous species.
2. Observations on food-taking, including:—
 - (a) The kind of material actually swallowed.
 - (b) The action of the mouth-parts.
 - (c) The progress of the material through the alimentary canal.
3. Experiments in keeping the animals on various kinds of food.

EXAMINATIONS OF INTESTINAL CONTENTS

If the kind of material found in the alimentary tract is a safe guide to the nature of the food of entomostracans, then the majority of those species with which I have dealt feed on unicellular green algae. It is by no means easy to indentify specifically the algae found in the alimentary canals of these animals, because of the finely-comminuted condition of most of the material, but here and there, by examining a large number of animals, one is able to find a cell sufficiently intact to determine the species with certainty. The determinations which I have made are as follows:—

Simocephalus serrulatus—palmella forms (these are spherical green algae of indeterminate systematic position, which will be discussed later), *Scenedesmus bijuga*, *S. quadricauda*, *Rhaphidium falcatum*, *Chlamydomonas communis*, *Pediastrum boryanum*, *P. tetras*, *Haematococcus pluvialis*.

Daphnia pulex pulicaria—palmella forms, very small colonies of *Volvox aureus*.

Daphnia retrocurva—palmella forms.

Ceriodaphnia reticulata—palmella forms, *Scenedesmus bijuga*, *S. quadricauda*. *Rhaphidium falcatum*.

Scapholeberis mucronata—palmella forms. *Scenedesmus bijuga*, *S. quadricauda*, *Chlamydomonas communis*. Small *Eremosphaera viridis*.

Sida crystallina—palmella forms, *Pediastrum boryanum*. *P. tetras*.

Bosmina longirostris—palmella forms, *Rhaphidium falcatum*.

Ophryoxus gracillis—palmella forms.

Pleuroxus hastatus—palmella forms.

Pleuroxus striatus—palmella forms.

Alona guttata—*Scenedesmus bijuga*, palmella forms.

Alona costata—*Chlamydomonas communis*, palmella forms.

Chydorus sphaericus—palmella forms.

Polyphemus pediculus—*Chlamydomonas communis*.

Cypridopsis vidua—*Chaetophora elegans*, *Conferva bombycina tenuis*, palmella forms.

Potamocypris smaragdina—palmella forms.

Cyprinotus incongruens—palmella forms.

Cypris fuscata—palmella forms.

Cyclocypris castanea—palmella forms, *Scenedesmus quadricauda*.

Cyclops bicuspidatus—*Chaetophora elegans*.

Cyclops fuscus—palmella forms, *Chlamydomonas communis*, chitin fragments.

Diaptomus birgei—palmella forms.

In the case of the higher animals the finding of certain substances in large quantity in the alimentary tract is taken as prima facie evidence that the animals feed on these substances, and a large part of our knowledge of the food of these animals, especially of birds and fishes, rests upon such evidence. Until very recently such evidence has been regarded as entirely satisfactory in the case of entomostracans, but the observations of Naumann (1920) that algal cells pass through the intestinal tract of some cladocerans in an apparently undigested condition, and observations of my own that under certain conditions algal cells are extruded apparently intact from the posterior end of the alimentary canal, throw some doubt on the validity of conclusions based on this evidence.

The question as to the weight which is to be given to evidence from the examination of intestinal contents of entomostracans is by no means a simple one, but involves several considerations. If entomostracans take into their alimentary tracts any material which is brought to the mouth by the current set up by the feet (in cladocerans) or by the maxillae (in copepods) and which is small enough to swallow, without any selection, and if much of this material is extracted in an apparently unchanged condition, then the data derived from the examination of intestinal contents is of no significance. If, however, there is selection of material—some kinds being swallowed and some kinds rejected, then it is prima facie evidence that the material swallowed is food material. If, moreover, it is ascertained by critical observation that a certain material does, under certain circumstances, undergo a change in the alimentary tract—even though under other circumstances this same material is extended apparently unchanged—this is further evidence that the material in question has a food value. Thus more than the mere examination of the intestinal contents is evidently necessary before sound conclusions can be drawn as to the food of any species of entomostracan, and the data given above must be considered in the light of the results attained by the other methods which are dealt with in succeeding sections.

While on the subject of the examination of intestinal contents I may state that I place very little reliance on evidence as to the nature of the food of any aquatic animal from the finding of "staubfeine Detritus" in the alimentary tract, as any material which is not too hard may be reduced to this condition by the activity of the digestive process.

ACTUAL OBSERVATIONS ON FOOD-TAKING IN ENTOMOSTRACANS

I have devoted a great amount of attention to this matter, chiefly because, at the time I began my investigations, there was apparently an entire lack of data on this subject, and, latterly, because of the bearing such observations have on the validity, or otherwise, of conclusions based on the examination of the contents of the intestinal tracts.

The difficulties of this work are very great, and I have brought into play many and various devices in an effort to surmount them. The main inherent difficulty is that the animal must be kept continuously in view for a considerable time and at the same time sufficient magnification must be employed to allow the recognition of each particle of material which is brought to the mouth, and to see the actual operation of swallowing. Some methods have proved effective with some species, but quite useless with others. The chief methods which I have employed are:—

1. The watching of the animals in a spectroscopic cell through a 12X hand-lens. This method is of use only in the case of large species and when the animals are feeding on algae—which have been previously, or may be subsequently, specifically determined under the compound microscope—or on some other definite food material, which lies close against the glass. This method has given fairly satisfactory data on some ostracods and some copepods.
2. The observation of animals in a spectroscopic cell through a compound microscope, with a "Davon" tele-microscopic attachment, the microscope being so mounted that it could be swung to follow the movements of an animal. This method, at first, seemed to hold great promise, but the difficulty, which, after trials of various powerful electric "spotlight" lamps, and systems of mirrors to reflect sunlight, proved insuperable, was to get sufficient illumination at magnifications high enough to allow of the specific recognition of food-material. This method, therefore, yielded only some data on the course of the currents which brought material towards the mouth in cladocerans.
3. The watching of animals on a slide, in a minimum amount of water, under the compound microscope. Various modifications of this method were tried, cells of different kinds being given a trial, and

in spite of the difficulty imposed by evaporation, which shortened the period of continuous observation, the use of an amount of water insufficient for the animals to swim in (with, of course, no cover glass) proved most satisfactory. This method gave some very good data on some species of cladocerans, especially *Simoccephalus serrulatus*, *Daphnia pulex pulicaria*, *Ceriodaphnia reticulata*, and *Sida crystallina*, but was of no use in the case of ostracods or copepods.

The use of very small cells (made by using a cardboard "form" the size and shape of the cell, covering this with rosin and beeswax cement, fastening it to a slide, and cementing a portion of a cover-glass over it) set up on the stage of an "erect image" (prism system) microscope, fixed in a horizontal position. The size of the cell had to be very nicely adapted to the size of the animal to be used, so as to allow sufficient room for the free movement of the appendages, but not enough room for the animal to move out of the field of view. This method yielded very good results in the case of copepods, more especially when only one kind of food material was supplied at a time, as the depth of the cell precluded the use of high powers. Of special value in this method was a battery of eye-pieces of various magnifications up to 25X, which permitted a rapid change to higher powers when the animal was in an exceptionally favourable position to observe the action of the mouth-parts.

Most work was done with *Simoccephalus serrulatus*. This species was seen to swallow palmella forms, *Haematococcus pluvialis*, *Scenedesmus bijuga*, *S. quadricauda*, *Rhaphidium falcatum*, *Tetraedron minimum*, and *Chlamydomonas communis*. An extensive series of observations upon the method of feeding and the rate of feeding in this species was carried out with the co-operation of R. Gordon Sinclair, the animals being placed in a hollow-ground slide with a suspension of palmella algae and observed through a compound microscope, various objectives and eye-pieces being employed as occasion demanded. The method of feeding is as follows:—The algae are strained out and packed between the bases of the feet by the fine setae on these appendages, and passed slowly forward until the masses of algae reach the anterior part of the thorax, at which point portions are introduced between the mandibles by the action of the maxillae. The mandibles, by a rotatory and oscillatory motion, grind the algae once between their distal surfaces after which the algae pass into the oesophagus. In the oral portion of the oesophagus the material is collected into balls, each of which, after reaching a definite size, is caused to pass to the stomach by the

constriction of the oesophageal walls. When the intestine has become more or less tightly packed with material a definite amount of excreta is ejected from the anus. However, not all the material which is packed between the bases of the feet and introduced between the mandibles, is eaten by the animal. When a much-entangled mass of material comes within the reach of the maxillae, or when some undesirable material is introduced between the mandibles, a very precise method of ejection comes into play. This method is as follows:—(1) the labium, which acts as a sort of slide on which the food is passed forward, is drawn downward and backward by the contraction of its attached muscles, (2) the first foot is bent at its basal joint and is drawn forward and upward, (3) with two or three rapid downward and backward motions of the first foot the undesired material is removed from between the mandibles by the two spines on the anterior face of the basal joint of the first foot, (4) the force of the rejection carries the material backward and among the legs, and, (5) with a powerful scoop of the post-abdomen the material is ejected into the water behind the animal. Large masses of entangled algae, *Euglena intermedia* and its cysts, *Paramoecium caudatum* and *P. bursaria*, were observed to be ejected in this manner.

An attempt was made to get some quantitative data on the food of *Simocephalus serrulatus*. Several animals were weighed on an analytical balance, each being left on filter paper for a standard time (15 seconds), to take off the surface water, before weighing. The individuals weighed ranged in weight from 1.3 to 0.7 milligrams, this range corresponding with a range in size from 2.944 mm. long by 1.984 mm. wide to 1.792 long by 0.1216 wide. It was found that a mass of pal-mella algae of 1.248 cu. mm. weighed 0.5 milligrams and contained 8,551,500 cells, which figures must, of course, be regarded as approximations only. The rate of feeding of 56 individuals was determined and the length of time required to fill the intestine with fresh material varied from thirty minutes to two hours and fifty-five minutes. This variation was so wide that an average figure would be entirely meaningless, and, moreover, precluded the acquisition of quantitative data on the food of this species.

Some figures which were obtained in the course of this investigation are, however, of interest. Twelve individuals were measured with a micrometer eye-piece, as to their length, breadth and thickness and the length and average diameter of the alimentary tract, and from these figures the mass of the animals and of their alimentary tracts was calculated. The average of these figures is as follows:—

Length of body	1.629 mm.
Breadth of body	0.963 mm.
Thickness of body	0.814 mm.
Length of stomach	0.187 mm.
Diameter of stomach	0.124 mm.
Length of intestine	1.455 mm.
Diameter of intestine	0.090 mm.
Mass of animal	1.274 cu. mm.
Volume of stomach	0.003 cu. mm.
Volume of intestine	0.0123 cu. mm.

Sida crystallina has been seen to eat palmella forms, *Pediastrum tetras*, and *Scenedesmus quadricauda*. The majority of *Volvox aureus* colonies are too big for it, as are also full-size specimens of *Eremosphaera viridis*. *Euglena intermedia*, *Paramoecium caudation*, *P. bursaria*, and *Astasia lagenula* were rejected. Though the food stream is continuous in this species, it does not eat continuously, as for various periods of time the labium may be kept up and the mandibles motionless. Observations on ten individuals which had been kept in filtered water until the contents of their alimentary tracts had changed from green to brownish-yellow and then placed, individually, on slides in a suspension of palmella algae, showed that they required from 15 to 28 minutes to fill the alimentary canal with fresh algae. After this the animals continued to feed, and when this process was continued at a rapid rate, much of the algae appeared to be extruded intact from the tract.

Ceriodaphnia reticulata was seen to swallow palmella forms, and *Rhaphidium falcatum*; *Daphnia pulex pulicaria* swallowed very small colonies of *Volvox aureus* and *Chlamydomonas communis*; *Scapholeberis mucronata* was seen, by a study of the very largest specimens, to eat palmella forms and *Chlamydomonas communis*; and *Polyphemus pediculus* was observed to swallow *Chlamydomonas communis*.

Exact observations on the food-taking of ostracods are very difficult on account of the opacity of the shell, but I have, under exceptionally favourable circumstances, seen *Cypridopsis vidua* crop the ends off the delicate filaments of *Chaetophora elegans*; and *Cyprinotus incongruens* scrape the coating of palmella algae from the angles of dead *Carex* stems and also take in minute portions of the muscle of dead insects.

Cyclops fuscus has been seen to take in palmella algae, and to seize, and partially devour small specimens of its own species and of *Diaptomus birgei*.

Diaptomus birgei has been observed to swallow palmella algae.

THE RAISING OF ENTOMOSTRACANS ON CERTAIN KINDS OF FOOD.

Whatever doubts may exist as to the validity of conclusions based upon the examination of intestinal contents, or even upon direct observations of the taking of material into the alimentary tract, there is no ambiguity about conclusions based on the raising of entomostracans on a certain food material.

I have produced pure cultures of palmella algae, as will be described later, and on this food-material I have reared many generations of the following species:—*Simocephalus serrulatus*, *Ceriodaphnia reticulata*, *Scapholeberis mucronata*, *Sida crystallina*, *Pleuroxus hastatus*, *Alona guttata*, *Alona costata*, *Chydorus sphaericus*, *Cypridopsis vidua*, *Cyprinotus incongruens*, *Cypris fuscata*, *Cyclocypris lutea*, *Cyclocypris forbesi*, *Cyclocypris castanea*, *Cypria exculpta*, *Cyclops serrulatus*, and one generation of *Cyclops fuscus*.

This is conclusive evidence that these species are able to live, grow, and reproduce upon a diet of planctonic Chlorophyceae. Knörrich (op. cit.) found the same thing to be true for *Daphnia pulex*. This is obviously a conclusion of supreme importance in regard to the culture of entomostraca, but it does not settle the question as to whether organic detritus may not also be able to function as nutritive material for entomostracans.

In order to get some light on this matter I undertook, with the co-operation of L. R. Merkley, a somewhat extensive series of experiments on the feeding of entomostracans on organic detritus.

What is organic detritus, or "staubfeine Detritus?" The only logical definition, to my mind, is—organic detritus is the fine sedimentary material resulting from the disintegration and partial decay of plant and animal matter. Under natural conditions there is no question but that this organic detritus must be mixed with a greater or lesser amount of inorganic detritus, and microscopic examination of detritus from the bottom of various aquatic habitats has shown me that the ratio of inorganic to organic material varies from about ten to about ninety per cent. As to the nutritive substances in organic detritus we have practically no data. The nearest approximation to an analysis of such detritus from the nutritive standpoint, that I know of, is the analysis of reed, "muck," peat, well decomposed, given by Dachnowski (1924) as follows:—ash, 16.65, crude protein, 17.69, crude fibre, 9.05, nitrogen-free extract, 45.20 and fat, 0.44%.

It was evidently necessary for the carrying out of these experiments to prepare organic detritus free from algal cells, and this proved to be more of a problem than was anticipated. Detritus was secured from the

bottom of a marshy pool, but it was, of course, rich in algal cells, chiefly *palmella* forms. The first method which was tried to obtain algal-free detritus was to stir up the detritus thoroughly in a little water, filter the mixture, allow the filtrate to stand, and collect the sediment with a pipette. When filtration was through varying thicknesses of absorbent cotton, algal cells passed through; when it was through filter-paper, of varying degrees of retentivity, only bacteria passed through; and when it was done under pressure through filter-paper in a Buchner funnel or through asbestos wool in a Gooch crucible, only bacteria and very minute protozoans (*Pleuromonas jaculans*) passed through. Consequently, after having exhausted the possibilities in the way of filtration, this method was abandoned.

The next method tried was heating the detritus to 60°C. When material thus treated was examined the algal cells seemed to be flaccid and apparently dead, but when kept for forty-eight hours and again examined there was a considerable growth of fresh algal cells. The detritus was next heated to 80°C, with substantially the same result.

The next method used was boiling the detritus for three minutes. The objection to this method is, obviously, that such a high temperature almost certainly causes a change in some of the organic compounds present so that one would not be justified in arguing from effects obtained by detritus thus prepared as to the rôle of natural detritus, and it was for this reason that lower temperatures were first tried. The effect of boiling was that the algal cells appeared to be dead and no fresh cells developed by the end of five days. A further objection to this method was that this mass of dead organic matter provides a most excellent culture-medium for bacteria, which multiplied in it enormously, and that to keep it in sterile condition meant the application of more heat.

Another method which was tried was spreading out the detritus in a very thin layer in a large glass dish and exposing to the sun until thoroughly dry. This method, which was tried without much hope of success because of the well-known ability of many algae, and especially algal spores, to withstand desiccation, gave results which were, contrary to expectations, fully as good as boiling. After moistening a sample of this dried detritus, and leaving it for five days, no living algal cells were visible. This method had the double advantage, over boiling, of avoiding the use of heat and allowing the material to be kept without the development of bacteria.

In most of the experiments both boiled and dried detritus were used, and the water used in all of these experiments was water from

Bocabec Lake or Tait's Pond which had been boiled, filtered, and aerated. Another difficulty however arose, one which necessitated the "scrapping" of some of the earlier experiments. This was that, after a lapse of from five to nine days, algal cells made their appearance among the detritus. This growth of algae was undoubtedly due to the multiplication of cells which were either attached to the animals when they were transferred to the experimental vials, or were extruded intact from their alimentary tracts. They were not introduced in water with the animals, as double transfer from filtered water was standard technique throughout, nor were they introduced by means of the pipettes, as these were kept filled with 25% hydrochloric acid when not in use. There is, of course, a possibility that some of this algal growth may have been due to the development of spores, but this seems unlikely for two reasons—firstly, most of the algae were palmella forms, which I have never seen to produce resistant spores, and secondly, no such growth took place in boiled detritus, or in moistened dried detritus, which was kept for ten days. In later experiments this difficulty was overcome by transferring the animals to vials containing fresh detritus every five days.

Before giving the results of these experiments there is a very interesting observation which should be mentioned. In some of the preliminary work with various kinds of prepared detritus I had three specimens of *Simocephalus serrulatus* which had been left in filtered water until their intestinal contents were brownish-yellow and then placed in a sample of previously heated detritus in which algal cells were so rare that at most two cells could be found in the field of a 16 mm. objective—which meant, roughly, that algal cells did not make up more than 1/10,000 of the material. When I examined the animals after they had been in the vial containing this detritus for forty-eight hours I found that their intestinal tracts were filled with fresh, bright-green, algal cells, and a re-examination of samples of the detritus showed that algal cells were as scarce as they had been in the beginning. The ability of the animals to gather so many algal cells when the latter were present in such extremely small numbers seemed almost unbelievable, but a repetition of the experiment gave a similar result, and this observation furnishes a very striking example of the selection of food by this cladoceran.

EXPERIMENTS ON DETRITUS AND ALGAE AS FOOD FOR *Scapholeberis*
Mucronata

Experiment F1. Three *Scapholeberis mucronata* in Bocabec water plus *Chlamydomonas communis*. Set up July 14.

- July 15. —3.
 „ 16. —2.
 „ 17-20.—2.
 „ 21. —2 and 4 jv.
 „ 22. —2 and 6 jv.
 „ 23. —2 and numerous jv.
 „ 24-31.—2 and numerous jv.
 Aug. 18. —five individuals.

Exp. F2. Duplicate of F1.

- July 15-17.—3.
 „ 18. —3 and 5 jv.
 „ 19. — „ „ „
 „ 20. —3 and 9 jv.
 „ 21. —3 and 10 jv.
 „ 23-25.— „ „ „ „
 „ 26. —3 and numerous jv.
 „ 27-31.— „ „ „ „
 Aug. 18. —9 individuals.

Exp. F3. Three *S. mucronata* in Bocabec water plus palmella algae.

- July 15. —3 and 1 jv.
 „ 16. —2 and 1 jv.
 „ 17. — „ „ „
 „ 18. — „ „ „
 „ 19. —1.
 „ 20. —Dead. A very heavy growth of algae.

Exp. F4. Duplicate of F3.

- July 15-17.—3 and 1 jv.
 „ 18. —3 and 3 jv.
 „ 19. —3 and 2 jv.
 „ 20. —1 and 1 jv.
 „ 21. —Dead. A very heavy growth of algae.

Note is made of the very heavy growth of algae which was present at the time these experimental animals died, because I have noticed in many cases that when a very abundant growth of algae has been present in a limited amount of water casualties have been heavy. No adequate explanation suggests itself.

Exp. F5. Three *S. mucronata* in pool water plus *Chlamydomonas communis*.

- July 15-19.—2 and 1 jv.
 „ 20. —2.

July 21-23.—2.

„ 24. —2 and 2 jv.

„ 25-30.—2 and 7 jv.

Aug. 18. —3 individuals.

Exp. F6. Duplicate of F5.

July 15-17.—3.

„ 18-20.—3 and 3 jv.

„ 21. —3 and 6 jv.

„ 22-23.—3 and numerous jv.

„ 24. —1 and 3 jv.

„ 25-31.—2.

Aug. 18. —2.

Exp. F7. Three *S. mucronata* in Bocabec water plus cooked detritus.

July 15-16.—2.

„ 17. —1.

„ 18. —Dead.

Exp. F8. Duplicate of F7.

July 15-16.—2 and 4 jv.

„ 17. —1 and 1 jv.

„ 18. —1.

„ 19. —Dead.

Exp. F9. Three *S. mucronata* in Bocabec water plus cooked detritus.

July 15-18.—3 and 1 jv.

„ 19. —3 and 3 jv.

„ 20. —3 and 2 jv. Growth of algae.

„ 21-25.—2 and 2 jv.

„ 26. —3.

„ 27. —3. Heavy growth of algae.

Exp. F10. Duplicate of F9.

July 15-19.—3 and 2 jv.

„ 20. —„ „ „ „ . Volvox, desmids and palmella algae present.

„ 21. —„ „ „ „

„ 22. —3.

„ 23. —2. Much Volvox and heavy growth of other algae.

Experiments H1, 2, 3, 4, 5, and H6 with *Ceriodaphnia reticulata* were rendered entirely inconclusive by the fact that algae developed in the boiled detritus on the fourth day, and all the animals had green algal cells in their alimentary tracts. Owing to a scarcity of animals of this species the experiment could not be re-set.

EXPERIMENTS ON *Alona costata*

Exp. K1. Three *Alona costata* in Bocebec water plus *Chlamydomonas communis*.

July 26.-Aug. 9.—3.

Aug. 10. —Dead.

Exp. K2. Duplicate of K1.

July 26.-Aug. 5.—3.

Aug. 6. —Dead.

Exp. K3. Three *A. costata* in Bocabec water plus palmella algae.

July 26.-Aug. 3.—3.

Aug. 4. —Dead.

Exp. K4. Duplicate of K3.

July 26.-Aug. 2.—3.

Aug. 3. —Dead.

Exp. K5. Three *A. costata* in Bocabec water plus boiled detritus.

July 27. —Dead.

Exp. K6. Duplicate of K5.

July 27. —Dead.

Exp. K7. Three *A. costata* in Bocabec water plus dried detritus.

July 27. —Dead.

Exp. K8. Duplicate of K7.

July 27. —3.

„ 28-31.—1.

Aug. 1. —Dead.

EXPERIMENTS ON *Ophryoxus gracilis*.

Exp. L1. Three *O. gracilis* in pond water plus *Haematococcus pluvialis*.

July 30. —3.

„ 31. —3 and 3 jv.

Aug. 1. —3 and 6 jv.

„ 2-4 —„ „ „ „

„ 5. —3 and 3 jv.

„ 6. —3 and 2 jv.

„ 7-8. —„ „ „ „

„ 9. —1.

„ 10. —Dead.

Exp. 12. Duplicate of 11.

July 30. 3.
 „ 31. —2 and 2 jv.
 Aug. 1. —2 jv.
 „ 2-3. —1 jv.
 „ 4. —Dead.

Exp. L3. Three *O. gracilis* in pond water plus palmella algae.

July 30. —3.
 „ 31. —2 and 2 jv.
 Aug. 1. —„ „ „ „
 „ 2. —Dead.

Exp. L4. Duplicate of L3.

July 30. —3.
 „ 31. —2.
 Aug. 1. —2.
 „ 2. —1.
 „ 3. —Dead.

Exp. L5. Three *O. gracilis* in pond water plus dried detritus.

July 30-31.—3.
 Aug. 1. —Adults dead, 3 jv.
 „ 2-3. —2 jv.
 „ 4. —Dead.

Exp. L6. Duplicate of L5.

July 30. —3.
 „ 31. —1.
 Aug. 1. —Dead.

Exp. L7. Three *O. gracilis* in pond water plus boiled detritus.

July 30. —3.
 „ 31. —2 and 3 jv.
 Aug. 1. —„ „ „ „
 „ 2-3. —2 and 2 jv.
 „ 4. —1.
 „ 5. —Dead.

Exp. L8. Duplicate of L7.

July 30. —3.
 „ 31. —2 and 6 jv.
 Aug. 1. —„ „ „ „
 „ 2-3. —1 and 2 jv.

Aug. 4-6. —1 and 1 jv.
 „ 7. —1.
 „ 8. —Dead.

Experiments N1, 2, 3, 4, 5, and N6 with *Sida crystallina* in Bocabec water and with *Haematococcus pluvialis*, boiled detritus and dried detritus, were quite inconclusive, as one set of animals with *H. pluvialis* lived 11 days, while the other set died on the second day, and the two sets with boiled detritus lived for 5 and 7 days, respectively, while both sets with dried detritus died on the second day.

EXPERIMENTS ON THE FOOD OF *Diaptomus birgei*.

In the experiments with this species two new types of food material—soluble starch and casein—were tried, and a variation—two sets being supplied with maximum palmella algae and two sets with minimum palmella algae—was introduced.

Exp. S1. Four *D. birgei* in pond water with minimum palmella algae.
 Aug. 12. —4.
 „ 13-15. —4.
 „ 16. —1.
 „ 17. —Dead.

Exp. S2. Nine *D. birgei* in same as above.
 Aug. 12-15. —9.
 „ 16-30. —8.
 „ 31-Spt. 10.—4 Exp. discontinued Spt. 10.

Exp. S3. Five *D. birgei* in pond water with maximum algae.
 Aug. 12. —5.
 „ 13. —Dead.

Exp. S4. Duplicate of S3.
 Aug. 13. —5.
 „ 13. —Dead.

Exp. S5. *D. birgei* in pond water plus dried detritus.
 Aug. 12. —6.
 „ 13. —4.
 „ 14-30. —3.
 „ 31. —1.
 Spt. 1. —Dead.

Exp. S6. Nine *D. birgei* in same as above.

Aug. 12. —9.

„ 13-22. —9.

„ 23-30. —7.

„ 31. —6.

Spt. 1. —Dead.

Exp. S7. Seven *D. birgei* in pond water plus boiled detritus.

Aug. 12. —7.

„ 13-20. —7.

„ 21-31. —6.

Spt. 1. —Dead.

Exp. S8. Eight *D. birgei* in same as above.

Aug. 12-19. —8.

„ 20-22. —7.

„ 23-29. —5.

„ 30-31. —4.

Spt. 1. —1.

„ 2. —Dead.

Exp. S9. Eight *D. birgei* in pond water plus soluble starch.

Aug. 12-15. —8.

„ 16-20. —6.

„ 21-23. —5. One animal removed for examination of intestinal contents.

„ 24-29. —4.

„ 30-Spt. 2. —3.

Spt. 3-4 —2.

„ 5. —Dead.

Exp. S10. Duplicate of above.

Aug. 12-15. —8.

„ 16-18. —6.

„ 19-25. —5.

„ 26. —4.

„ 27-30. —3.

„ 31-Spt. 1. —2.

Spt. 2. —1.

„ 3. —Dead.

Exp. S11. Nine *D. birgei* in pond water plus casein (pure).

Aug. 12-13. —9.

„ 14. —Dead. Solution putrid.

Exp. S12. Duplicate of S11. Results exactly similar.

From this set of experiments it would appear as if this species can derive its nutriment either from small planctonic algae or from fine organic detritus. The lethal effect of the presence of too large a quantity of algae is apparent. It would appear as if this species can digest soluble starch as a specimen from (S9) was on Aug. 23 washed in several changes of distilled water, and placed in a weak iodine solution, when a mass in the intestine gave the starch reaction. The decomposition of the casein was undoubtedly the cause of the sudden death of the animals in S11 and S12, and this indicated that this method of experimenting with pure proteins as nutriment for entomostracans is not feasible.

EXPERIMENTS ON THE FOOD OF *Cyprinotus incongruens*.

Exp. W1. Three *C. incongruens* in pond water plus minimum palmella algae.

Aug. 20-Spt. 6.—3.

Spt. 7-10.—2. Exp. discontinued.

Exp. W2. Duplicate of W1.

Aug. 20-Spt. 10.—3. Exp. discontinued.

Exp. W3. Three *C. incongruens* in pond water plus maximum algae.

Aug. 20-Spt. 10.—3. Exp. discontinued. Several young.

Exp. W4. Duplicate of W3.

Aug. 20-Spt. 10.—3. Exp. discontinued.

Exp. W5. Three *C. incongruens* in pond water plus boiled detritus.

Aug. 20-25.—3.

„ 26-29.—1.

„ 30. —Dead.

Exp. W6. Duplicate of W5.

Aug. 20-25.—3.

„ 26. —2.

„ 27-29.—1.

„ 30. —Dead.

Exp. W7. Three *C. incongruens* in pond water plus dried detritus.

Aug. 20-25.—3.

„ 26. —2.

„ 27. —1.

„ 28. —Dead.

Exp. W8. Duplicate of W7.

Aug. 20-26.—3.

„ 27-28.—2.

„ 29-31.—1.

Spt. 1. —Dead.

The results of this set of experiments are perfectly clear-cut, and they show, moreover, that this species is not affected adversely by the presence of a large amount of algae.

EXPERIMENTS ON THE FOOD OF *Cypridopsis vidua*.

The results of this set of experiments—Y1-Y6—with algae, and boiled and dried detritus, may be summarized as follows. The last animal in one vial with algae died after 15 days, while in the other vial with algae two of the animals were alive after 25 days, when the experiment was discontinued. The last of the animals in both of the vials with boiled detritus died after 9 days, and the last of the animals in the vials with dried detritus died after 15 days, and 16 days, respectively. This would indicate that this species derives nutriment both from algae and from detritus, but that the former is the preferable food-material.

EXPERIMENTS OF THE FOOD OF *Cypria exculpta*.

The results of these experiments—V1-V4—may be thus summarized. The last animal in one vial with algae died after 18 days, and in the other vial with algae 2 of the animals lived to the end of the experiment (25 days). In one of the vials with dried detritus one animal died on the second day, another on the fourth day, and the last on the eleventh day; in the other vial with dried detritus one animal died on the second day, and the remaining two animals on the thirteenth day. Thus it would seem that this species derives nourishment from both algae and detritus, but thrives better on the former.

EXPERIMENTS ON THE FOOD OF *Cyclops fuscus*.

One set of experiments was set up as follows:—

- B1. One *C. fuscus*, with egg-sacs, in pond water, plus palmella algae.
- B2. One *C. fuscus*, with egg-sacs, in one-half pond water and one-half M. culture solution, plus algae.
- B3. One *C. fuscus*, with egg-sacs, in one-half M. solution and one-half leaf infusion, plus algae. Experiments set up on July 1.

The results may be summarized as follows:—

B2 died on July 6.

B3 lived until July 15, by which time the algae had increased enormously. B1 had the following history, which is of interest because it gives some data on the rate of growth of the young:—

- July 4. —Eggs hatched.
 „ 5-6. —1 ad. and numerous nauplii.
 „ 7-8. —1 ad. and 3 metanauplii.
 „ 9. —1 ad., 2 metanauplii, 1 young in 1st copepod stage.
 „ 10-13.—3 copepods. Adult dead.
 „ 14. —3 copepods.
 „ 15. —3 young in 1st cyclops stage.
 „ 16-23—3 young in a cyclops stage.
 „ 24. —2 adults. Experiment discontinued.

Experiments D1-D4, with *C. fuscus* in pond water plus algae and three kinds of detritus, set up on July 10, resulted as follows:—

- D4, with algae, dead on July 17.
 D1, with filtration detritus (bacteria and minute protozoans), dead on July 19.
 D2, and D3, with boiled and dried detritus, respectively, lived until July 20, when the experiment was discontinued on account of a growth of algae.

Experiments G1-G8, set up on July 18, were as follows:—

- G1, One *C. fuscus* with egg-sacs, and one without egg-sacs, in 1/3 leaf infusion and 2/3 M solution diluted with 1/2 water, plus palmella algae.
 G2. Duplicate of above.
 G3. Two *C. fuscus* (as above) in Bocabec water plus boiled detritus.
 G4. Duplicate.
 G5. Two *C. fuscus* (as above) in 1/3 leaf infusion and 2/3 M solution diluted with 1/2 water, plus boiled detritus.
 G6. Duplicate.
 G7. Two *C. fuscus* (as above) in Bocabec water, plus palmella algae.
 G8. Duplicate.

Results were, briefly, as follows:—

- G1. Both lived to end of experiment on July 25.
 G2. Both dead on July 20.
 G3. Both lived to end. Growth of algae on July 24.
 G4. Both lived to end.
 G5. Both lived to end. Large number of protozoans on July 21.
 G6. Both lived to end. Large number of protozoans on July 21.
 G7. Dead on July 20.
 G8. Dead on July 23.

This experiment was discontinued on July 25, because of the protozoans and algae present in the detritus.

Experiments J1-J6, with *Chlamydomonas communis* and two kinds of detritus, and O1-O6, with *Haematococcus pluvialis* and two kinds of detritus, gave results in favour of detritus in both cases.

Summarizing these experiments with *Cyclops fuscus* it would appear that this species is omnivorous—thus bearing out data from other sources—and that the presence of large quantities of algae in a limited amount of water is inimical to it.

EXPERIMENTS ON THE FOOD OF *Simocephalus serrulatus*.

The earlier experiments with this species were quite inconclusive, as animals which appeared to be thriving on boiled and dried detritus were found to have fresh algal cells in their intestinal tracts. In Exp. M1-M6, with *Haematococcus pluvialis* and two kinds of detritus, one set of three with the algae died on the second day, the other set on the third day, of those with boiled detritus the last animals died on the eighth and the ninth days, respectively, and of those with the dried detritus the last animals died on the ninth day and the third day, respectively. In experiments T1-T4 with algae and boiled detritus, the three animals with algae were dead, in one case, on the third day, and in the other on the fifth day, while the animals with detritus lived until the tenth day in one case, and two of the animals lived until the end of the experiment (13 days) in the other case.

Experiments P1-P6 are given in detail because they bring out some interesting points in regard to the culture of this species.

Experiment P1. Three *S. serrulatus* in a $\frac{1}{2}$ oz. vial with pond water and palmella algae.

Aug. 5-7. —3.
 „ 8. —1.
 „ 9. —Dead.

Experiment P2. Three *S. serrulatus* in a 4 oz. bottle with pond water and palmella algae.

Aug. 5-14. —3.
 „ 15. —3 adults and 5 jv.
 „ 30. —21.
 Spt. 12. —40.
 „ 30. —100 (+ —).
 Oct. 15. —160 (+ —).

- Nov. 1. —180 (+ —).
 Feb. 20. — 60 (+ —). Nearly all ephippial.
 Mar. 1. — 25. (Two adults transferred to P2A).
 Mar. 8. —Dead.

Of the adults transferred to $\frac{1}{2}$ leaf infusion and $\frac{1}{2}$ pure pond water, with addition of palmella algae, on March 1, one had 3 and the other 7 eggs. They were subsequently re-transferred after the production of each brood, and gave broods as follows—No. 1: 3 jv. on March 8, 6 jv. on March 14, 4 jv. on Mar. 22, 4 on Mar. 28, dead on Ap. 1. No. 2: 7 jv. on Mar. 12, 7 jv. on Mar. 19, 3 jv. on Mar. 27, dead on Ap. 2.

Experiment P3. Three *S. serrulatus* in a $\frac{1}{2}$ oz. vial with pond water and boiled detritus.

- Aug. 5-7. —3.
 „ 9. —2.
 „ 10-11.—1.
 „ 12. —Dead.

Experiment P4. Three *S. serrulatus* in a 4-oz. bottle with pond water and boiled detritus.

- Aug. 5. —3.
 „ 5-8. —2.
 „ 9. —Dead.

Experiment P5. Three *S. serrulatus* in a $\frac{1}{2}$ oz. vial with pond water and dried detritus.

- Aug. 5. —3.
 „ 6. —2.
 „ 7. —Dead.

Experiment P6. Three *S. serrulatus* in a 4-oz. bottle with pond water and dried detritus.

- Aug. 5. —3.
 „ 6. —2.
 „ 7-11.—1.
 „ 12. —Dead.

The interest of this set of experiments lies, of course, in P2. I am not inclined to think that the fact that there was a larger volume of water in P2 than in P1 was the decisive factor, as subsequent experiments did not warrant such a conclusion, though it is possible that it *may* have had something to do with the matter. I am inclined to believe, rather that I had here chanced to get three animals of higher

"viability," of a more resistant strain, than most individuals of this species. This idea of resistant strains, which may apply to all entomostracans, is certainly indicated by a very large number of my experiments with *Simocephalus serrulatus*. This species is, as I know to my cost, decidedly "freaky" under experimental conditions, and I think that this "freakiness" is very largely explained by the viability or non-viability of different strains. The second point of interest is the way in which this culture kept increasing, by parthenogenetic reproduction and with the appearance of very few ephippia, until the bottle was crowded, when the animals were nearly all ephippial and the culture died out rapidly. This bears out, most excellently, the conclusions of Grosvenor and Smith (op. cit.) and several observations of my own on other cultures. The resumption of rapid parthenogenetic reproduction by the two individuals transferred to fresh culture medium when the old culture was dying out, is quite conclusive evidence that the nature of the reproduction in this species is not a cyclic phenomenon but is directly dependent on external factors.

THE CULTURE OF ENTOMOSTRACA

Naturally the matter of culture has entered, more or less, into some phases of the subjects which have been dealt with in the foregoing sections of this paper, as the work presented in the previous sections was undertaken to secure data which would lay a foundation for a system of producing entomostracans in quantity. In the present section the matter of mass cultures of entomostracans, first in the laboratory, and later under field conditions, will be dealt with.

From the investigations on food-relations which have been presented it is evident that planctonic Chlorophyceae are the chief source of nutrition for a considerable number of entomostracans. It is therefore plain that the first step in the production of mass cultures of these entomostracans is the culture of these algae in any desired quantity.

THE CULTURE OF ALGAE AS FOOD FOR ENTOMOSTRACA

As is well known to algologists, solutions of nutrient salts promote the growth of algae, and several such solutions have been originated and used by various workers. Of these I selected those of Molisch, Moore and Knop. The formulae of these solutions are as follows:—
Molisch Solution:—

Water, distilled 1,000 cc.

KNO₃ 0.8 grms.
 KH₂PO₄ 0.4 "
 MgSO₄ 0.4 "
 FeSO₄ (1% sol.) 10 minims.

Moore's Solution:—

Water, distilled 1,000 cc.
 NH₄NO₃ 0.5 grms.
 KH₂PO₄ 0.2 "
 MgSO₄ 0.2 "
 CaCl₂ 0.1 "
 FeSO₄ (1% sol.) 10 minims.

Knop's Solution:—

Water, distilled 1,000 cc.
 KNO₃ 0.5 grms.
 KH₂PO₄ 0.5 "
 MgSO₄ 0.5 "
 Ca(NO₂)₂ 2. "
 FeSO₄(1% sol.) 10 minims.

Comparative tests of these solutions showed that Moore's solution gave the best results, but that growth was relatively slow in all cases. I had noticed in the course of my ecological field work that the best growth of plancton algae occurred in pools in which there were considerable quantities of dead leaves, and this suggested that some organic substance dissolved out of these leaves might be favourable to the development of these algae. I consequently obtained a quantity of dead leaves of *Acer pennsylvanicum*, placed 25 grammes in 500 cc. of distilled water, heated to 60°C, let stand for 24 hours with frequent squeezing strained through cheese-cloth, and filtered. This procedure gave a clear light brown fluid, with a "leafy" odour. The work of Arteri (1901) and Knörrich (op. cit.) indicated that peptone gave an acceleration of growth in the case of some species of Chlorophyceae, so that I made up a 1% solution of Peptonum siccum to use, together with the leaf infusion, in a series of comparative tests. This series was set up, in duplicate, as follows:—Equal quantities (equality being attained in this matter by producing a homogeneous suspension and using one drop of this suspension, delivered from the same pipette) of mixed algae from Habitat A were placed in test-tubes containing the following solutions:—

1. Molisch solution.
2. Molisch $\frac{3}{4}$ plus Peptone $\frac{1}{4}$.
3. Molisch $\frac{1}{2}$ plus Leaf-infusion $\frac{1}{2}$.

4. Moore's solution.
5. Moore's $\frac{3}{4}$ plus peptone $\frac{1}{4}$.
6. Moore's $\frac{1}{2}$ plus leaf-infusion $\frac{1}{2}$.
7. Knop's solution.
8. Knop's $\frac{1}{2}$ plus leaf-infusion $\frac{1}{2}$.
9. Knop's $\frac{1}{2}$ plus leaf-infusion $\frac{1}{2}$ plus 0.5% FeCl_2 .
10. Knop's $\frac{1}{2}$ plus leaf-infusion $\frac{1}{2}$ plus 0.5% NaHCO_3 .
11. Tap water.

These were set up on August 10, and it was apparent by August 14 that there was a great difference in the efficiency of the different solutions. Critical examination on August 20 showed:—

1. No growth.
2. Fair growth, great development of bacteria and moulds.
3. Good growth, practically free from bacteria and moulds.
4. No growth.
5. Fair growth, immense development of bacteria and moulds.
6. Good growth, few bacteria and moulds.
7. Fair growth, few bacteria and moulds.
8. Good growth, few bacteria and moulds.
9. Good growth, few bacteria and moulds.
10. Poor growth, algae brown, large numbers of bacteria.
11. Decrease.

Examination of September 4 showed:—

1. Poor growth.
2. Poor growth, immense numbers of bacteria and moulds.
3. Good growth.
4. Fair growth.
5. Fair growth, large numbers of bacteria.
6. Excellent growth (increase estimated at about 60 times) practically free from bacteria and moulds.
7. Poor growth.
8. Good growth.
9. Good growth.
10. A proportion of the algae were green. Many bacteria present.
11. Decrease.

Examination of the material showed that No. 6—Moore's $\frac{1}{2}$ plus leaf-infusion $\frac{1}{2}$ —was most favourable to the increase of the planktonic Chlorophyceae, as at the end of the experiment the material consisted almost entirely of Palmella-forms, *Scenedesmus bijuga* and *Coelactrum proboscideum*, with very few Cyanophyceae or Protozoa.

Previous to this series of experiments, which I have mentioned first because it is the most complete set, I had run a lot of experiments with Molisch solution, Molisch solution plus peptone, and Molisch solution plus leaf-infusion. In all cases the addition of peptone gave an increase in growth of the algae, but an even greater increase in bacteria and moulds, while the addition of the leaf-infusion gave a marked increase in algae with the production of few bacteria or moulds. Experiments with Moore's solution, pure, with peptone and with leaf-infusion, gave similar results.

I have frequently mentioned "Palmella-forms" in speaking of the food of entomostracans and also as one of the algae which increase very rapidly on culture in a Moore solution plus leaf-infusion medium. In a very great many cases where a mixed "stock" of algae—such for instance as one from Habitat A the species of which are listed in the report on this habitat—is used, these Palmella-forms increase to such an extent that they finally constitute practically the entire mass of algae produced by cultivation. This is true also for culture with Molisch solution pure, Molisch solution plus leaf-infusion, and Moore's solution pure. The fact that these "Palmella-forms" are so eminently suitable for culture, and enter so largely into the food-relations of the entomostraca, renders it of considerable interest to know their systematic status and their life-history, and I have carried on extensive investigations in regard to these matters. A full discussion of this subject, which is in fact one of the most difficult problems in the whole field of algology, and the presentation of the data which I have so far accumulated concerning these algae, would be out of place in this paper, and must be reserved for separate presentation at a later date. A brief discussion of the matter is, however, desirable here.

The algae which I include under the general term "palmella-forms" are spherical, or nearly spherical, unicellular or colonial Chlorophyceae which are present in greater or less numbers in all collections of fresh-water algae. This includes forms which have been described as constituting the genera *Palmella*, *Chlorococcum*, *Chlorella*, *Gloeocystis*, *Planktosphaeria*, *Chlorobotrys*, *Botrydiopsis*, *Chlorosphaera*, *Protococcus*, *Palmellococcus*, *Heterococcus*, *Pleurococcus*, *Schizochlamys*, *Sphaerocystis*, and *Tetraspora*, and as long as one confines himself merely to the examination of these forms as they occur in collections of algae from various habitats he can place all the forms as belonging to some species or other of one of these genera. But as soon as one resorts to the method of pure culture, isolating single cells, or single colonies, of

these forms, he begins to doubt the adequacy and the precision of the classification of these forms, as forms which would appear, from critical microscopic examination, to belong to the same species, behave quite differently when cultured under exactly similar conditions. Some produce only cells which resemble very closely the original cell, others produce cells which differ widely from the original form, others produce filaments of greater or less length and complexity of branching, while still others develop into filamentous forms which are definitely recognizable as belonging to some species or other of the genera *Stigeoclonium* or *Chaetophora*. Moreover, the form and size of the "palmella-forms" is influenced to an extraordinary degree by changes—such as variation of the pII concentration, salt concentration, and presence of organic compounds—in the culture medium. Furthermore, some of these algae, while simple in structure, have very complicated life-histories. Most of the literature concerning these algae is purely descriptive, but a considerable amount of cultural work has been done on them by Artari (1892), Klebs (1896), Livingston (1900), Chodat and Adjaroff (1903), Snow (1903), Chodat (1909), and Schramm (1917). The result of this cultural work so far has been, to my mind, to raise problems rather than to settle them, and it is only by long-continued investigations by pure culture methods, and by constant checking of the data thus obtained against field-factorial data, that the taxonomy of these forms can be put in a satisfactory condition.

The fact that organic material in solution greatly augments the growth of planctonic Chlorophyceae is perfectly evident from my experiments and bears out the results obtained by Artari (1901), Knörrich (op. cit.), and Snow (op. cit.). But while the fact is plain enough, the actual causative factor of this increased metabolism is, as yet, entirely obscure. The suggestion that the active growth-augmenting agent might be in the nature of a vitamin is a hypothesis which at once strikes one as having some degree of probability. Bottomly (1914, 1914a, 1917, 1920) has claimed that a vitamin-like substance is present in extracts of peat, but his contention has been refuted by other workers (v. Mendiola, 1919; Clark and Roller, 1924, Sacger, 1925). In the case of my leaf-infusion I put the matter to the following test. Cultures of palmella algae were set up, equal quantities of a homogeneous suspension of cells and equal volumes of solution being used in all cases, and to these were added different proportions of leaf-infusion as follows:— $\frac{1}{2}$ volume, $\frac{1}{4}$ volume, $\frac{1}{8}$ volume, $\frac{1}{16}$ volume, 10 drops, 5 drops and 1 drop. If the active agent were a vitamin one would expect that, within limits, the growth-rate would be increased as much

by the addition of small quantities as by large. As a matter of fact the increase of the algae was in direct proportion to the amount of leaf-infusion added with the exception that very small quantities gave no measurable augmentation of growth, and this, while not absolutely conclusive evidence, indicates that the increase in growth is due to some organic substance which is assimilated and not to a vitamin. As to what the organic compound in question may be, it is, in the present state of our knowledge, dangerous even to hazard a guess. In an infusion of dead leaves there are unquestionably very large numbers of organic compounds present, such as proteoses, polypeptids, amino-acids, hemi-celluloses, pentoses, pentosans, glucosides, pectins and tannins, and as some of these groups are as yet imperfectly known chemically, it is evident that a satisfactory analysis of such a complex medium as a leaf-infusion is practically impossible at the present time.

LABORATORY CULTURES OF ENTOMOSTRACA

Having developed a satisfactory method of producing planctonic Chlorophyceae in any desired quantity the next step was the raising of mass cultures on the algae thus produced. Experiments on this matter were carried out in four ways:—

1. The culture medium was added to a collection of material containing both algae and entomostracans, by substituting the culture medium, as far as feasible, for the water from the habitat.
2. By taking some of the mixed "stock" of algae and placing a little of this, together with a few entomostracans of a given species, in a culture vessel.
3. By raising quantities of palmella in culture solution, and placing a little of this, together with selected entomostracans, in a culture vessel.
4. By keeping entomostracans in filtered tap water, and feeding every day with palmella grown in culture solution.

Results obtained by method No. 1:—

A. On June 15 about a hundred specimens of *Cyprinotus incongruens* were brought, together with water from the pool, from Habitat N. Twigs, with a very thin coating of algae, from the same pool were placed in the vessel. The animals remained in practically undiminished numbers until July 1, when bacteria began to appear in large quantities. No noticeable growth of algae had occurred. By July 16 only three individuals of *Cyprinotus* were left. On that date Molisch solution plus leaf-infusion was added. By July 24 there was a noticeable growth

of algae and a marked decrease in bacteria. By July 26 there was an immense increase in algae, chiefly palmella algae and *Scenedesmus bijuga*, and there were 27 young *Cyprinotus*. By August 12 there were very large numbers (some 150) young *Cyprinotus*, and the algal growth was still increasing. On Aug. 19 the growth of algae on the sides of the vessel was decreasing, and the vivid green, which indicates rapid growth of these forms, was less marked. On Aug. 20 the algae were assuming a decidedly yellowish tinge, and the pH of the culture was now 6.8 (that of the original solution was pH 5.8). Half the solution was poured off and more Molisch plus leaf-infusion added. By Aug. 25 there was a noticeable renewal of algal growth. By September 7 the water was green with palmella and very small forms of *Scenedesmus* and there were 60 *Cyprinotus* of adult size and 237 young.

B. On June 17 twenty-one specimens of *Cyclocypris castanea* were brought from a small grassy pond. These were reduced to two (by the taking of specimens for dissection) by June 22. Molisch solution plus leaf-infusion was added to the vessel containing these two individuals. By June 28 marked growth of *Scenedesmus* was evident. By July 20 there were 22 *Cyclocypris*. By Aug. 3 there were 110 and 20 were taken out for dissection. By September 7 there were 180 (estimated) and by September 13 there were 323 (by actual count).

C. On July 26 Molisch solution plus leaf-infusion was added to material from Habitat D, in which *Scapholeberis mucronata* and *Ceriodaphnia quadrangula* were present. By Aug. 10 there was a great increase (approximately 40 times) in algae, chiefly palmella and *Scenedesmus bijuga*, and a marked increase in the entomostracans. By Aug. 17 there were hundreds of *S. mucronata* and over a hundred *C. quadrangula*, the increase in the latter being estimated at about 60 times. By Aug. 22 there was a further increase in algae, and in *S. mucronata*. *C. quadrangula* was forming ephippial eggs and dying out. By Aug. 25 *S. mucronata* was forming ephippial eggs and dying out.

D. On Aug. 1 material from Habitat G, with *Cyclops fuscus*, was brought in. No increase in algae and very few nauplii of *Cyclops* by Aug. 20. Added Moore's solution plus leaf-infusion. By September 1 there was a marked increase in algae, chiefly *Scenedesmus quadricauda* and *Rhaphidium falcatum*, and increase in nauplii. By September 12 there were very numerous nauplii and metanauplii of *Cyclops* and a large number of females carrying egg-sacs.

Results attained by method No. 2.

A. On July 7 three adults of *Scapholeberis mucronata* were

placed in Moore's solution plus leaf-infusion with algae from Hab. A. The three individuals had respectively 1 well advanced embryo, 2 well-advanced embryos and 2 nearly mature embryos. The algae grew well and the history of this culture was follows:—

- July 8. 3 adults.
 „ 9. „ „ 3 young.
 „ 10. „ „ 5 young.
 „ 11. „ „ „ „
 „ 12. 3 adults two with embryos, 5 young.
 „ 13. „ „ „ „ „ 2 young of nearly adult size.
 „ 14. „ „ „ „ „ 5 young of nearly adult size.
 „ 15. 8 adults.
 „ 16. „ „
 „ 17. „ „ numerous young.
 „ 18. „ „ „ „
 „ 20. „ „ „ „
 „ 21. „ „ „ „
 „ 22. „ „ „ „ of several broods, some nearly
 adult size.
 „ 23. Numerous adults, numerous young.

No change until July 28, when experiment was discontinued because the culture was becoming crowded, and the animals were transferred to other cultures.

B. Six adults of *Scapholeberis mucronata*, one with 4 eggs, the others clear (i.e., eggs or embryos) were placed in Moore's solution plus leaf-infusion, with algae 1821 on July 18. The algae grew well and there was no change in the animals until July 27, when there were several young. The subsequent history was as follows:—

- July 29. 6 adults, numerous young.
 „ 31. 6 adults, numerous young.
 Aug. 2. 16 young of nearly adult size.
 „ 3. 24 adults, 4 with ephippia, numerous young.
 „ 17. „ „ 9 with ephippia, several shed cphippia, numerous
 young.
 „ 21. Numerous adults, many with ephippia.

C. Ten *Alona costata* placed in Moore's solution plus leaf-infusion, diluted with 10 times water, with algae from Habitat S, on Aug. 4. On Aug. 10 there were 720.

Results attained by method No. 3:—

A great many of the cultures mentioned under "The Environ-

mental Factors" come under this head. The following are examples of this method.

A. Three individuals of *Simocephalus serrulatus* were placed in Moore's solution plus leaf-infusion with palmella algae from stock culture. The specimens of *S. serrulatus* had respectively 6 well-advanced embryos, 2 well-advanced embryos and 1 well-advanced embryo. The algae grew well, and the history of this culture was:—

- July 4. Set up.
- „ 5. 1 adult dead. Brood of 6 young.
- „ 6. 1 adult with 5 eggs. Several young.
- „ 7. 1 adult with 5 eggs „ „
- „ 8. 1 „ „ „ „ 1 with 4 eggs. Several young.
- „ 9. „ „ „ „ embryos, 1 with 4 eggs. Several young.
- „ 10. „ „ „ „ „ 1 with 4 eggs. Several young.
- „ 11. „ „ „ „ „ 1 with 4 embryos. Several young.
- „ 12. „ „ „ 4 „ 1 clear, numerous young.
- „ 13. Young of adult size.
- „ 15. Numerous adults and numerous young.

B. Three young *Simocephalus serrulatus* placed in Moore's solution plus leaf-infusion, with algae from stock culture on July 21. Good growth of algae, but no change in animals until July 29.

- July 29. 1 with 3 eggs, 1 with 1 egg, 1 clear.
- Aug. 1. 1 with 3 embryos, 1 with 2 eggs, 1 with ephippium.
- „ 7. 1 with ephippium dead, 1 with 5 embryos, 1 with 4 eggs.
- „ 11. 2 clear. Several young.
- „ 12. 1 with 5 eggs, 1 with 6 eggs. Several young.
- „ 14. 1 with 5 embryos, 1 with 6 embryos. Several young.
- „ 22. 2 with 6 embryos. Numerous young of various broods.
- „ 29. Young of adult size, and numerous smaller young, 1 adult with ephippium.

C. One *Simocephalus serrulatus* with 6 embryos (stage 4) placed in Moore's solution plus leaf-infusion with algae from stock culture on Aug. 5.

- Aug. 6. Adult clear. 6 young.
- „ 7. „ „ „ „
- „ 11. No change since Aug. 7.
- „ 12. Adult with 17 eggs. 6 young.
- „ 14. Adult with 17 eggs removed to another culture. 6 young.
- „ 18. 2 young, nearly adult size.
- „ 20. 1 with 6 eggs, 1 with 9 eggs.

- Aug. 21. 1 with 6 embryos, 1 with 9 embryos.
 „ 24. 1 with 9 eggs, 1 with 10 eggs. Several young.
 „ 25. 1 with 9 embryos, 1 with 10 embryos. Several young.
 „ 27. 1 adult clear, 1 with 10 embryos. Several young.
 „ 29. 1 with 9 eggs, 1 with 6 eggs. Numerous young.
 „ 30. 1 with 9 embryos, 1 with 6 embryos. Numerous young.
 Sept. 1. 1 with 4 eggs, 1 clear, numerous young of 3 broods.

Results attained by method No. 4:—

A. Three adults of *Sida crystallina* placed in tap water on July 18 and fed with palmella from stock culture. They had respectively 5 embryos, 7 eggs and 9 eggs. On July 20 there were five young. The adults lived until the experiment was discontinued on September 6, when there were 37 young of various broods.

B. Three adults of *Daphnia pulex pulicaria* placed in tap water on July 19, 1923, and fed with palmella from stock culture. By September 6 there were two adults and numerous young.

It is not to be inferred from the foregoing that these methods have always proved to be an unqualified success, as there have been cases in which cultures which have been treated, as far as known, in identically the same manner as successful cultures, have died out. Sometimes it has been allowable to connect these failures with some possible cause, as bacteria in the case of *S. serrulatus*, or Chlorangium in the case of *Ceriodaphnia reticulata*, but frequently the unsatisfactory verdict "death due to causes unknown" has been the only statement which could be made.

CULTURE OF ENTOMOSTRACA UNDER FIELD CONDITIONS

In reviewing the literature on raising entomostracans in the field as food for young fish one is struck by the fact that a good deal has been written as to the great possibilities of such a procedure but that very little has actually been done. As Kendall (1921) says in regard to this matter, "To state that a project is feasible is one thing; to demonstrate it is another."

Raveret-Wattell (1887), in describing the method of raising entomostracans as food for young trout at the Grenaz establishment in France, says, "Daphniae were raised in the very basins which were destined for the fish," and refers to "Daphniae, forming dense clouds in the water."

Mason (1887), writing of Gremaz, says, "the process of Mr. Lugrin, which has been patented in several countries, consists in spread-

ing upon the bottom of the tanks a material impregnated with the elements necessary to produce spontaneously a limitless number of *Daphnia*, *Cyclops* and *Limnaea*, as well as fresh-water shrimps." He gives no information as to the nature of this wonderful patented spontaneous generator of the desired forms of life.

Seal (1892) suggested methods of raising entomostracans and other small crustaceans but presented no actual data.

Kochs (1892) made use of cow manure, which gave rise to bacteria and infusoria on which he claimed *Daphnia*, *Cyclops* and *Cypris* thrived.

Page (1894) deals with this subject and gives, in an appendix, a report by Chabot-Karlen on the raising of entomostracans by Durand at the School of Agriculture at Beaume, the method used being the placing of *Potamogeton* and *Nasturtium officinale* in holes dug in clayey land, when *Conferva* and *Vaucheria* developed and partially decayed and in this mixture of partially decayed plants *Cyclops* was said to become abundant.

Raveret-Wattell (1898) described a method of raising entomostracans in use at Rouen, France, this method being the filling of a basket, weighted with rocks, with horse manure, sinking it in a cask, and introducing some *Daphnia*, which multiplied rapidly.

Knörrich (1900), after a review of the production of zooplankton by the use of manure, says, "Alle diese beobachteten Erscheinungen lassen den Schluss zu, dass die Gegenwart organischer Stoffe für die Entstehung einer Mikroorganismenwelt ausserordentlich günstig ist, und diese Thatsache wird in vielen Fällen für die praktischen Massnahmen auch ohne weiteres genügen."

Kendall (1921) gives a review of the literature on the production of small crustaceans as fish-food. He says, "There can be no doubt that these crustaceans would afford a most valuable food supply for young fishes if their culture should prove practicable on a scale to meet the demand"—and—"If a system of crustacean culture can be devised which will meet the demand of the fish-culturist and the fish-farmer, it will be a boon of inestimable importance. This paper does not pretend to devise such a system."

My experiments on the field culture of entomostracans were begun in 1922. I had six cement tanks constructed, with walls and bottom four inches thick, the interior dimensions being 2 ft. by 2 ft. by 1 ft. deep, and fitted with taps. Four of these were placed in the open and two in the woods. After a thorough washing three of the tanks were filled to within three inches of the top with Moore's solution plus leaf-

infusion diluted with twice the volume of tap water (from Chamcook Lake, a body of water in a granitic region), and a culture of palmella algae was placed in each tank. Instead of increasing, the algae died out, and the explanation of this came when the pII of the liquid in the tanks was found to be over 10. Evidently the calcium of the fresh cement was going into solution rapidly, and a rough quantitative analysis for calcium showed that about two and a half times as much of this element was present in the liquid in the tanks as had been present in the solution which had been added. Treatment of the walls and bottom of a tank with H_2SO_4 resulted in no improvement. Lining a tank with puddled clay, and allowing it to stiffen before adding water was a failure, as the clay fell off the sides of the tank as soon as it became wet. Three of the tanks were then coated inside with hot paraffin, and algal cultures started in them were moderately successful, though the pH still ranged from 8.8 to 9.6. *Simocephalus serrulatus*, *Scapholeberis mucronata*, *Ceriodaphnia reticulata*, *Chydorus sphaericus*, *Cyclops fuscus* and *C. serrulatus* introduced into these tanks died out promptly and they did the same in water from the tanks in glass vessels. The paraffin coating on the inside of the tanks was heavy and there is no reason to believe that any calcium could possibly come through it, but the rise in Hydrogen ion concentration was undoubtedly due to the fact that it was impossible to keep a thick coating of paraffin on the rims of the tanks and on the walls above the water line, as the heat of the sun melted the paraffin and it ran off, so that rain carried calcium into the tanks. Here operations for this season ceased and it was thought that the weathering of the cement from September until the following June would remedy the trouble.

In June, 1923, the tanks were filled with water, and after allowing twenty-four hours to elapse a reading of the pII was made. This, much to our disappointment, ranged from 9.4 to 10. The tanks were all paraffined, those which had previously been treated being scraped to remove the scaly paraffin which still adhered in places, and filled with the culture solution mentioned above. The algal cultures started in the tanks grew rapidly and there was an enormous production of palmella. The pH of the liquid in the tanks naturally varied with the amount of photosynthesis, but it was never lower than 8.4 and all the entomostracans introduced into the tanks died out. A more acid culture solution was tried, but the results were the same, and these operations were abandoned at the end of the season with the knowledge, most arduously gained, that new cement, even after weathering for a winter, is a failure for entomostracan culture.

In June, 1924, the tanks were again tested, as it was thought that possibly the cement would have weathered sufficiently by this time, but the pH was still high, and, while the algae did well in them, the entomostracans died out as promptly as ever.

These continued attempts to make use of cement tanks were due to the fact that this material is unquestionably the most suitable, both from the standpoint of construction and permanence, for receptacles for the field culture of entomostracans, and the result of these experiments, though disappointing in the extreme, are of value in that they clearly show that cement cannot be used for this purpose.

While the tests of the tanks were being made in 1924 other receptacles for the field cultures of entomostracans were prepared. These were of three kinds:—

1. Wooden boxes, paraffined on the inside, 2 ft. by 2 ft. by 1 ft. deep.
2. A hole, three feet deep and two feet across, dug in gravelly soil, lined with puddled clay, and coated with fine washed gravel.
3. A series of holes dug in a clay subsoil and lined with fine washed gravel.

The paraffined boxes at first seemed to be satisfactory. Algae grew well in them, and *Cyprinotus incongruens* and *Alona costata* increased to a marked extent. *Cyclops fuscus* died out in a box, from what cause it is difficult to say. Later the boxes gave rise to trouble due to the melting of the paraffin by the sun and its running out of the upper parts of the seams, so that the water-tight part of the boxes became progressively less.

The hole in the gravelly soil was lined with puddled clay and filled with water on June 16. Next day the bottom, and the sides as far as possible, were coated with fine washed gravel. On July 19 twenty-five *Cyprinotus incongruens* were placed in it and a supply of palmella. On July 29 there were numerous young. By July 1 the water had evaporated to one-third its original bulk and was replenished by means of a bucket and a syphon. It was found that the incoming water, even when thus relatively slowly introduced, stirred up the clay so that the water became extremely turbid. A sponge was fastened to the end of the syphon when more water was added on July 3, and this prevented the turbidity. Water had to be added to this pool every three to six days, depending on the weather conditions. By July 12 there were very large numbers of *Cyprinotus* present. On July 16 the pool was found

completely dry, and the evidence furnished by a round hole in the bottom indicated that someone had pushed a stick through the clay lining.

Of the pools made in a clay subsoil three were at the edge of an open marshy place in the woods where they received full sunlight from 9 o'clock until 6 o'clock in July, and two were in a boggy spot in the spruce woods where they were densely shaded. The amount of light received by the latter pools was 2% of that received by the former when the sun was shining and 10% of that received by the former pools on a cloudy day. All the holes were filled with water (pH. 6.4) from a deep hole, in the centre of the open marshy place, which had been dug some years ago and kept tightly covered. This water contained no entomostracans and had no growth of algae. In all cases palmella algae, which had been grown in Moore's solution plus leaf-infusion in one of the paraffined cement tanks, was placed in the pools. In the case of the pools in the open no subsequent addition of algae was necessary, but in the case of the densely shaded pools the supply of algae had to be replenished at intervals.

Pool No. 1, in the open, dug on July 9, was stocked with 25 *Cyprinotus incongruens* on July 12. They did extremely well and by July 20 there were many young. By Aug. 15 *Cyprinotus*, adults and young of various sizes, were very abundant. It was obviously impossible to make an actual count, or even a close estimate, of the numbers under field conditions, but a rough conservative estimate places the number at 500 on Aug. 20.

It is worthy of special note that the period from the beginning of July until the middle August was unusually dry, so dry, in fact that all the pools, including several spring pools, within a radius of several miles had dried up. This condition was very clearly proven by the fact that on Aug. 6 a trip of forty-five miles was made by motor car with the object of securing entomostracans for experimental purposes, and every place where pools were known usually to exist, or which looked to be a likely site of a pool, was examined, but every site of a pool was entirely dry. Consequently not a single pool-inhabiting entomostracan could be found throughout this whole stretch of country and the only individuals of these species which were living at this time were those in the pools which we had dug and had kept filled with water, and those which were in our laboratory cultures. The significance of this fact lies in the bearing it has upon the views

expressed by some writers, as Seal (op. cit.) and Muntadas (1887), that the raising of entomostracans is unnecessary as a plentiful natural supply is always available for fish-feeding operations.

On Aug. 23 came a torrential rain of over twenty-four hours duration. We had no accurate rain-gauge data, but some of my cement pools, into which there was no "run-in" except a very limited amount from the flat rim, showed a rise of water-level of six inches. The result, naturally, was that all my dug pools were completely overflowed. The site of the three in the open place was now a "lake" of many yards in extent, and the site of the two in the woods was another smaller sheet of water. After the water had subsided an examination of the brim-full pools showed that the numbers of entomostracans in the pools had greatly diminished, and that the majority had evidently been washed out and scattered over the whole marshy area. The inhabitants of the three pools had, naturally, become mixed up, and *Cyprinotus*, which was formerly present only in one pool was now present in all three. This species was, however, still present in larger numbers in its original pool than in either of the others, and continued to increase, with the result that by September 10 there were considerable numbers present in this pool.

Pool No. 2, in the open place which was dug on July 12, was stocked with 10 *Cyclops fuscus*, and 25 *Scapholeberis mucronata*. Some of the former species lived, but showed no increase (though the presence of nauplii was, of course, impossible to detect under field conditions) until the occurrence of the "cloud-burst." The latter species showed some increase but did not become abundant.

Pool No. 3, in the open, which was dug on July 12, was stocked with 25 *Simocephalus serrulatus*. Some continued to live, but their rate of reproduction was low, and there was no marked increase in numbers up to the time of the wash-out.

Pool No. 4, in the woods, which was dug on July 9, was stocked with 25 *Cyprinotus incongruens*, all of which had apparently died out by July 20. It was re-stocked with *Cyclops fuscus*, July 15, and some, at least, lived until the flood.

Pool No. 5, in the woods, which was dug on July 12, was stocked with 25 *Simocephalus serrulatus* and 25 *Scapholeberis mucronata*. By July 25 there was a decided increase in the numbers of both species, and they continued to increase until the over-flowing of the pool.

ACKNOWLEDGEMENTS

It is a pleasure to acknowledge the generous assistance which has been accorded me in the prosecution of this research, and to express my thanks to the following:—To Dr. J. G. Needham for suggesting this problem and for his counsel throughout the course of the work. To Dr. A. P. Knight, Chairman of the Biological Board of Canada, to the Biological Board, and to Dr. A. G. Huntsman, Director of the Atlantic Biological Station, for quarters and facilities for carrying on this investigation. To the Honorary Advisory Council for Scientific and Industrial Research for grants for the purchase of apparatus and supplies. To my colleague, Dr. Guilford Reed, for aid in the bacteriological and biochemical phases of the problem. To Miss Margaret Wilton, and Messrs. R. Gordon Sinclair, J. Russel Martin and L. R. Merkle for their co-operation on certain phases of the investigation. And to Mr. Nathan VanPatten, Librarian of Queen's University, and Mr. E. R. B. Willis, Assistant Librarian of Cornell University, for facilitating bibliographic work in their respective libraries.

SUMMARY

1. Entomostraca constitute one of the most important foods of a large number of fresh-water fishes during their early life, and of some species throughout their lives.
2. It is consequently highly desirable to establish a system of culturing these minute crustaceans as food for young fish.
3. Success in culture can only be obtained through a knowledge of the life-history, the food-relations, and the environmental requirements of the animals concerned.
4. The vast mass of literature in Entomostraca deals with their systematics, distribution and life-cycle. In regard to their food-relations and the influences of environmental factors, the literature is entirely contradictory.
5. Ecological field studies yield data on environmental requirements of the various species. Detailed studies of numerous habitats are presented.
6. The life-cycle of Cladocerans is dependent upon environmental conditions. The accumulation of excretory products, and increasing salt concentration, seem to be the chief factors in bringing about the ephippial condition in certain species.
7. The tolerance in regard to Hydrogen ion concentration varies in different species. Those with a wide pH range are also tolerant

over a wider range of other factors and hence are more suitable for culture than those with a narrow pH range.

8. Light is an important environmental factor for entomostracans. It has previously been considered only from the standpoint of phototactic response. The growth-rate of *Cyprinotus incongruens* is faster in full light than in 50% light or in darkness.
9. A raised temperature—27-32°C—hastens the rate of parthogenetic reproduction, but shortens the length of life, in some cladocerans.
10. Negative results were obtained from experiments on photoperiodism with *Scapholeberis mucronata*. This factor might, however, be effective in the case of limnetic species.
11. The chief enemies of entomostracans are—fish, dragonfly nymphs and Hydra. They are also eaten by Corethra, young larvae of Dytiscus, tadpoles of *Rana sylvatica*, and by the entomostracans *Leptodora kindtii* and *Cyclops fuscus*.
12. The chief food of the entomostracans experimented with is planctonic Chlorophyceae, though some species can unquestionably make use of fine organic detritus.
13. The best algae to culture as food for entomostracans are “palmella forms,” i.e., unicellular, spherical Chlorophyceae of uncertain systematic position. The status of these algae is briefly discussed.
14. The most satisfactory medium for the culture of these algae is Moore’s nutrient salt solution and leaf infusion. The rôle of the latter in the metabolism of these forms is considered.
15. *Simocephalus serrulatus* and *Sida crystallina* exhibit a definite choice of food. The method of rejection in the former species is described in detail.
16. There is some evidence that in *Simocephalus serrulatus* there are strains which are more “viable” than others.
17. Some results obtained suggest that certain bacteria may be pathogenic for entomostracans.
18. The epizoötic protozoon, Chlorangium, appears to affect *Ceriodaphnia reticulata* injuriously.
19. Tanks of new cement are a failure for bulk production of entomostracans, because the calcium continually goes into solution and raises the pH above the range of tolerance of these animals.
20. Wooden tanks, well paraffined, are satisfactory except that the paraffin melts off in the hot sun and the upper joints become leaky.

21. Holes dug in the soil and lined with puddled clay, then with fine gravel, are satisfactory as far as living conditions are concerned, but they are not likely to prove permanent.
22. Holes dug in clay soil are entirely satisfactory, provided ample side-drainage is provided to prevent the over-flowing of the pools.

LITERATURE CITED

- Agar, W. E. 1914. Parthenogenetic and Sexual Reproduction in *Simoccephalus vetulus* and other Cladocera. *Jour. Genetics.* 3:179.
- Apstein, C. 1896. *Das Süßwasserplankton.*
- Artari, A. 1901. Zur Ernährungsphysiologie der grünen Algen. *Ber. Deutsch bot. Gesel.* 19:
- Baird, W. 1850. *Natural History of the British Entomostraca.*
- Baker, F. C. 1916. The Relation of Mollusks to Fish in Oneida Lake. *Tech. Pub. No. 4, N.Y. State College of Forestry.*
- Banta, A. M. 1921. Selection in Cladocera on the Basis of a Physiological Character. *Car. Inst. Washington Pub. No. 305.*
- Bert, P. 1869. Sur la question de savoir si tous les animaux voient les mêmes rayons que nous. *Arch. de physiol.* 2:547.
- Bigelow, N. K. 1923. The Food of Young Suckers in Lake Nipigon. *Univ. Toronto Studies. Pub. Ont. Fish. Research Lab. No. 21.*
- Birge, E. A. 1897. Plankton Studies on Lake Mendota. 2. *Trans. Wisc. Acad. Sc. Arts and Let.* 21:274.
- Bottomley, W. B. 1914. Some Accessory Factors in Plant Growth and Nutrition. *Proc. Roy. Soc. B.* 88:237.
-1914a. The Significance of Certain Food Substances for Plant Growth. *Ann. Bot.* 28:531.
-1917. The Isolation from Peat of Certain Nucleic Acid Derivatives. *Proc. Roy. Soc. B.* 90:39.
-1920. The Growth of Lemna Minor Plants in Mineral Solutions and in their Natural Media. *Ann. Bot.* 34:345.
- Chodat et Adjaroff. 1903. Culture des Algues. *Arch. d. Sc. phys. et Nat.* 15:353.
- Chodat, R. 1909. Étude critique et experimental sur le polymorphisme des Algues. *Genève.*
- Clark, N. A. and Roller, E. M. 1924. "Auximones" and the Growth of the Green Plant. *Soil Sc.* 17:193.
- Clemens, W. A. and Bigelow, N. K. 1922. The Food of Ciscoes in Lake Erie. *Univ. of Toronto Studies. Pub. Ont. Fish. Research Lab. No. 3.*

- Clemens, W. A., Dymond, J. R. and Bigelow, N. K. 1924. Food Studies of Lake Nipigon Fishes. *Ibid.* No. 25.
- Dachnowski, A. P. 1924. The Chemical Analysis of Various Peat Materials by Means of Foodstuff Analyses. *Jr. Agr. Res.* 29:69.
- Dakin, W. J. 1908. Notes on the Alimentary Canal and Food of the Copepoda. *Int. Rev. ges. Hydrobiol. u. Hydrog.* 1:772. (Marine Copepoda).
- Davenport, C. B. and Lewis, F. I. 1899. Phototaxis of *Daphnia*. *Sci. N. S.* 9:368.
- Dodds, G. S. 1915. A Key to the Entomostraca of Colorado. *Univ. Col. Studies.* 11:265.
-1917. Altitudinal Distribution of Entomostraca in Colorado. *Proc. U.S. Nat. Mus.* 54:59.
-1920. Entomostraca and Life Zones. *Biol. Bull.* 39:89.
- Ekman, S. 1905. Die Phyllopoden, Cladoceren und freilebenden Copepoden Nordschwedischen Hochgebirge. *Zool. Jahrb. Syst.* 21:1.
-1914. Die Bodenfauna des Vattern, qualitative and quantitative untersucht. *Int. Rev. ges. Hydrobiol. u. Hydrog.* 7:146.
- Esterly, C. O. 1907. Reaction of *Cyclops* to Light and Gravity. *Am. Jr. Physiol.* 18:47.
- Forbes, S. A. 1880. On the Food of Young Fishes. *Bull. Ill. State. Lab. Nat. Hist.* 1:60.
-1883. The Food of the Smaller Fresh-water Fishes. *Ibid.* 1:61.
-1888. Studies of the Food of Fresh-water Fishes. *Ibid.* 2:434.
- Fordyce, C. 1901. The Cladocera of Nebraska. *Studies from the Zool. Lab. Univ. of Neb.* No. 42.
- Franz, V. 1910. Phototaxis und Wanderung. *Int. Rev. Ges. Hydrobiol. u. Hydrog.* 3:306.
- Freidenfelt, T. 1913. Zur Biologie von *Daphnia longiremis* und *Daphnia cristata*. *Int. Rev. ges. Hydrobiol. u. Hydrog.* 6:229.
- Garner, W. W. and Allard, H. A. Effect of the Relative Length of Day and Night and Other Factors on Growth and Reproduction of Plants. *Jour. Agr. Res.* 18:553.
- Green, W. R. 1919. Studies on the Life-cycle of *Simocephalus vetulus*. *Biol. Bull.* 37:49.
- Griffiths, B. 1923. The Phytoplankton of Bodies of Fresh Water and the Factors Determining its Occurrence and Composition. *Jour. Ecology.* 11:184.

- Grosvenor, G.H., and Smith, G., 1913. The Life-cycle of *Moina rectirostris*. *Quart. Jour. Micr. Sci.* 43:511.
- Hankinson, T. L. 1908. A Biological Survey of Walnut Lake. Michigan. Rpt. Geol. Sur. Mich. for 1907. p. 155.
- Hardy, W. B. and McDougall, W. 1893. On the Structure and Functions of the Alimentary Canal of *Daphnia*. *Camb. Phil. Proc.* 8:41.
- Hartmann, O. 1920. Studien über die Cyclomorphose bei Cladoceran. *Arch. f. Hydrobiol.* 10:236.
- Herrick, C. L. and Turner, C. H. 1895. Synopsis of the Entomostraca of Minnesota. *Geol. and Nat. Hist. Sur. of Minn. 2nd Rpt. of State Zoologist.*
- Huntsman, A. G. 1924. Limiting Factors for Marine Animals. 1. The Lethal Effect of Sunlight. *Contr. Can. Biol. N.S.* 2:83.
- Jssakowitsch, A. 1907. Geschlechtsbestimmende Ursachen bei den Daphniden *Arch. f. Mikr. Anat.* 69:223.
- Juday, C. 1903. The Diurnal Movements of Plankton Crustacea. *Trans. Wisc. Acad. Sci. Arts and Let.* 14:534.
- Keilhack, L. 1906. Zur Biologie des *Polyphemus pediculus*. *Zool. Anz.* 30:911.
-1909. Zur Bedeutung der Generationszyklen bei den Cladoceren. *Int. Rev. ges. Hydrobiol. u. Hydrog.* 2:238.
- Kemmerer, G., Bovard, J. F. and Boorman, W. R. A. 1923. Northwestern Lakes of the United States: Biological and Chemical Studies with Reference to Possibilities in the Production of Fish. *Bull. U. S. Bur. Fish.* 39:51.
- Kendall, W. C. 1921. Fresh-water Crustacea as Food for Young Fishes. *U.S. Bur. Fish. Document No.* 914.
- Kerb, H. 1910. Ueber den Nährwert der im Wasser gelösten Stoffe. *Int. Rev. ges. Hydrobiol. u. Hydrog.* 3:496.
- Kerhevé, L. B. de. 1892. De l'apparition provoquée des ephippies chez les Daphnies (*Daphnia magna*). *Mem. Soc. Zool.* 5:227.
- Klebs, G. 1896. Die Bedingungen der Fortpflanzung bei einigen Algen und Pilzen. Jena.
- Klugh, A. B. 1925. Ecological Photometry and a New Instrument for Measuring Light. *Ecology.* 6:203.
- Knörrich, F. W. 1900. Studien über die Ernährungsbedingungen einiger für die Fischproduction wichtiger Mikroorganismen. *Forschb. Biol. Sta. Plön.* 3:1.
- Knauthe, K. 1907. Das Süßwasser. Neudamm.

- Kurz, W. 1874. Ueber androgyne Missbildung bei Cladoceren. Sitz. Math. Naturw. Akad. Wien Ab. 1. 69:45.
- Kuttner, O. 1909. Untersuchungen über Fortpflanzenverhältnisse und Vererbung bei Cladoceren. Int. Rev. ges. Hydrobiol. u. Hydrog. 2:633.
- Langerhans, V. H. 1909. Ueber experimentelle Untersuchungen zu Fragen der Fortpflanzung, Variation und Vererbung bei Daphniden, Verh. d. deutsch Zool. Gesell. p. 281.
- Leim, A. H. 1924. The Life-history of the Shad (*Alosa sapidissima*) with Special Reference to the Factors Limiting its Abundance. Contrib. Can. Biol. N.S. 2: No. 11.
- Lemmermann, E. 1897. Resultate einer biologischen Untersuchung von Forellenteichen. Forschb. Biol. Sta. Plön. 5:67.
- Lipschütz, A. 1913. Die Ernährung der Wassertiere durch die gelösten organischer Stoffe der Gewässer. Ergeb. d. Physiol. 13:1.
- Livingston, B. E. 1900. On the Nature of the Stimulus which Causes the Change of Form in Polymorphic Green Algae. Bot. Gaz. 30:289.
- Lohman, H. 1909. Ueber die Quellen der Nahrung der Meerestiere und Püters Untersuchungen hierüber. Int. Rev. ges. Hydrobiol. u. Hydrog. 2:10.
- Lubbock, J. 1881. On the Sense of Colour among Some of the Lower Animals. Pt. 1 Jour. Linn. Soc. (Zool.) 16:121.
- Mackay, H. H. 1924. A Quantitative Study of the Plankton of the Shallow Bays of Lake Nipigon. Univ. of Toronto Studies. Pub. Ont. Fish. Res. Lab. No. 26.
- Marcovitch, S. 1924. The Migration of the Aphididae and the Appearance of Sexual Forms as Affected by the Relative Length of Daily Light. Jour. Agr. Res. 27:513.
- Mast, S. O. 1911. Light and the Behaviour of Organisms. p. 277, 280.
- MacDougall, D. T. 1903. The Influence of Light and Darkness on Growth and Development. Mem. N.Y. Bot. Gard. 5:319.
- McClendon, J. F. 1900. The Effect of External Conditions upon the Reproduction in *Daphnia* and the Structure of the Ephippium. Am. Nat. 44:523.
- Mendiola, N. B. 1919. Variation and Selection within Clonal Lines of *Lemna Minor*. Genetics. 4:151.
- Merejkowsky, M. C. 1881. Les Crustacés inférieurs distinguent-ils les couleurs? Comp. Rend. Acad. Sc. Paris. 93:1160.
- Moore, E. 1920. Some Plants of Importance in Fish Culture. U.S. Bur. Fish. Document No. 881.

- Moore, E. 1922. The Primary Sources of Food of Certain Food, Game and Bait Fishes of Lake George. *In* A Biological Survey of Lake George. N.Y. State Conser. Com.
- Muntadas, F. 1887. Report on the Piscicultural Establishment of Piedra, Aragon, Spain. Bull. U.S. Fish. Com. 7:211.
- Naumann, E. 1918. Ueber die natürlliche Nahrung des limnesche Zooplanktons. Ein Beitrag zur Kenntniss des Stoffhaushalts im Süßwasser. Lunds Universitets Arsskrift N.F. Avd. 2 Bd. 14. Nr. 31.
-1920. Spezielle Untersuchungen über die Ernährungsbiologie des tierischen Limnoplanktons. 1, Ueber die Technik des Nahrungserwerb hie den Cladoceren und ihre Bedeutung für die Biologie der Gewässertypen. *Ibid.* Bd. 17. Nr. 4.
-1921. Die Bodenablagerungen des Süßwassers. Arch. f. Hydrobiol. 13:97.
-1923. Speziell Untersuchungen über die Ernährungsbiologie des Tierischen Limnoplanktons. 2. Ueber den Nahrungserwerb und die natürliche Nahrung der Copepoden und der Rotiferen des Limnoplanktons. Lunds. Univ. Arsskr. N.F. Avd. 2 Bd. 19. No. 6.
- Needham, J. G. 1908. Report of Entomological Field Station Conducted at Old Forge, N.Y. in the Summer of 1905. Bull. N.Y. State. Mus. No. 124. p. 172.
-1922. A Biological Survey of Lake George, N.Y. N.Y. State Conser. Com.
- Ostwald, W. 1904. Experimentelle Untersuchungen über den Saisonpolymorphismus bei Daphniden. Arch. f. Entwicklmech. d. Organ. 18:415.
- 1907. Zur Theorie der Richtungsbewegungen niederer schwimmenden Organismen. Arch. f. ges. Physiol. 117:384.
- Papinicolaou, G. 1910. Experimentelle Untersuchungen über die Fortpflanzungsverhältnisse bei Daphniden. Biol. Cent. 30:639, 737, 753, 785.
- Parker, G. H. 1901. Reactions of Copepods to Various Stimuli and the Bearing of this on Daily Depth Migrations. Bull. U.S. Fish. Comm. 1901.
- Pearsall, W. H. 1922. A Suggestion as to the Factors Influencing the Distribution of Free-floating Vegetation. Jour. Ecol. 9:16.
-1923. A Theory of Diatom Periodicity. Jour. Ecol. 11:165.
- Pearse, A. S. 1918. The Food of the Shore Fishes of Certain Wisconsin Lakes. Bull. U.S. Bur. Fish. 35:247.

- Pearse, A. S. and Achtenburg, H. 1920. Habits of Yellow Perch in Wisconsin Lakes. Bull. U.S. Bur. Fish. 36:279.
- Pond, R. H. 1905. The Biological Relation of Aquatic Plants to the Substratum. U.S. Fish. Com. Rpt. for 1903, p. 483.
- Popoff, M. 1907. Depression der Protozoenzelle und der Geschlechtszellen der Metazoen. Arch. f. Protistenk. Supp. Bd. I.
- Pütter, A. 1908. Die Ernährung der Wassertiere. Zeit f. all. Physiol. 7:
-1911. Die Ernährung der Wassertiere durch gelöste organische Verbindungen. Pflügers Arch.
-1909. Die Ernährung der Wassertiere und der Stoffhaushalt der Gewässer. Jena.
- Radl, E. 1901. Ueber der Phototropismus einiger Arthropoden. Biol. Cent. 21:75.
- Reed, G. B. and Klugh, A. B. 1924. The Correlation between Hydrogen ion Concentration and the Biota of Granite and Limestone Pools. Ecology. 5:272.
- Reighard, J. 1913. An Ecological Survey of the Fishes of Douglas Lake, Cheboygan County, Michigan, in Midsummer. Bull. U.S. Fish. Com. 33:219.
- Reinsch, F. K. 1924. Die Entomostrakenfauna in ihrer Beziehung zur Macroflora der Teiche. Arch. f. Hydrobiol. 15:251.
- Ruttner, F. 1914. Bemerkungen zur Frage der vertikalen Planktonwanderung. Int. Rev. ges. Hydrobiol. u. Hydrog. Biol. Sup. 1914.
- Ryder, J. A. 1881. The Protozoa and Protophytes Considered as the Primary on Indirect Source of the Food of Fishes. Bull. U.S. Fish. Com. 1:236.
-1888. The Food of the Sturgeon. Bull. U.S. Fish. Com. 8:263.
- Saeger, A. 1925. The Growth of Duckweeds in Mineral Nutrient Solutions with and without Organic Extracts. Jr. Gen. Physiol. 7:517.
- Seal, W. P. 1892. The Present Status of Trout Culture. Trans. Am. Fish. Soc. 1892. P. 33.
- Schacht, F. W. 1897. North American Species of Diaptomus. Bull. Ill. State Lab. Nat. Hist. 5:141.
- Scharfenberg, U. V. 1910. Studien und Experimente über die Eibildung und der Generationzyklus von *Daphnia magna*. Int. Rev. ges. Hydrobiol. u. Hydrog. Biol. Sup. 1910.
-1914. Weitere Untersuchungen an Cladoceren über die experimentelle Beeinflussung des Geschlechts und der Daueibildung. Int. Rev. ges. Hydrobiol. u. Hydrog. Biol. Sup. 1914.

- Schmankewitsch, W. 1877. Zur Kenntnis des Einflusses der äusseren Lebensbedingungun auf die Organisation der Tier. Zeit. Wiss. Zool. 29:429.
- Scott, T. 1899. The Invertebrate Fauna of the Inland Waters of Scotland. 17th Ann. Rpt. of the Fishery Board of Scotland.
- Smith, G. W. 1915. Life-cycle of Cladocera. Proc. Roy. Soc. B. 88:418.
- Snow, J. 1903. The Plankton Algae of Lake Erie. Bull. U S Fish. Com. for 1902. pp. 369-394.
- Spandl, H. 1924. Cladoceren fliessender Gewässer. Arch. f. Hydrobiol. 15:227.
- Stingelin, T. 1897. Ueber jahreszeitliche, individuelle und lokale Variation bei Crustaceen. Forsch. Biol. Sta. Plön. 5:150.
- Straus, M. 1821. Mem. du Museum d'Hist. Nat. (Citation from Baird, 1850).
- Thienemann, A. 1912. Die Faktoren welche die Verbreitung der Süswasserorganismen regeln. Arch. f. Hydrobiol. 8:267.
- Tournais, J. 1912. Influence de la lumière sur la floraison du houblon japonais et du Chanvre. Compt. Rend. Acad. Sc. Paris. 155:297.
- Turner, G. H. 1910. Ecological Notes on the Cladocera and Copepoda of Augusta, Georgia. Trans. St. Louis Acad. 19:151.
- Vavra, W. 1891. Monographie Ostracoden Böhmens. Arch. d. nat. Landesf. von Böhmen. Bd. 8. Nr. 3.
- Wagler, E. 1923. Ueber die Systematik, die Verbreitung und der Abhängigkeit der Daphnia cucullata von physikalischen und chemischen Einflüssen des Milieus. Int. Rev. ges. Hydrobiol. u. Hydrog. 11:41.
- Warren, E. 1900. On the Reaction of Daphnia magna to Certain Changes in its Environment. Quart. Jour. Micr. Sc. 43:199.
- Weismann, A. 1877. Beiträge zur Naturgeschichte der Daphnoiden. Die Eibildung bei den Daphnoiden. Ztschr. f. Wiss. Zool. 28:93.
-1880. Beiträge zur Naturgeschichte der Daphnoiden. Samen und Begattung bei Daphnoiden. Ibid 33:55.
- Wesenberg-Lund, C. 1908. Plankton Investigations of the Danish Lakes.
- Wolff, M. 1909. Ein einfacher Versuch zur Pütterschen Theorie von der Ernährung der Wasserbewöhner. Int. Rev. ges. Hydrobiol. u. Hydrog. 2:715.
- Woltereck, R. 1909. Weitere Experimentelle Untersuchungen über Artveränderung, speziell über Wesen quantitativeer Artunterscheide bei Daphniden. Verhdl. d. deutsch Zool. Gesel. 1909.
-1911. Beiträge Analyse der Vererbung erworbener

Eigenschaften. Transmutation und Prainduction bei Daphniden.
Ibid.

.....1911a. Ueber Veränderung der Sexualität bei Daphniden.

Int. Rev. ges. Hydrobiol. u. Hydrog. 4:91.

Yerkes, R. M. 1899. Reactions of Entomostraca to Stimulation by Light.

Am. Jour. Physiol. 3:157.

.....1900. Reactions of Entomostraca. 2. Reactions of
Daphnia and Cypris. Ibid. 4:405.

Zacharias, O. 1903. Ueber die jahrezeitliche Variation von Hyalodaphnia
kahlbergensis. Scheodl. Forschb. Biol. Sta. Plön. 10:293.

Zschokke, F. 1900. Die Tierwelt der Hochgebirgseen. Neu Denskr.
d. Schweiz. naturf. Ges. Bd. 37.

THE NEARCTIC SPECIES OF THE GENUS RHAPHIUM
MEIGEN (DOLICHOPODIDAE, DIPT.)

By C. H. CURRAN,
Entomological Branch, Dept. of Agriculture, Ottawa.

(Continued from Vol. XV, p. 260)

1. *Rhaphium nigrociliatum* new species
(Figs. 1, 2, 3).

Length 5 to 5.5 mm. Face velvet-brown, beard brown, front four coxae black pilose; femora blackish with black hairs; squamae with brown cilia; genital lamellae divided. A very distinct species on account of the above combination of characters.

Male. Face narrow, deep brown, narrowest in the middle. Front opaque brown. Occiput deep green, the ground colour obscured by brown pollen; orbital cilia black, rather fine, extending about to the middle of the eyes; lying mostly below the middle are eight to ten long hairs on either side which curve forward; beard brown with more or less rusty tinge. Palpi black, with black hairs. Antennae black, the third joint about twice as long as wide, tapering to a rounded point; penultimate joint of arista swollen, the last section rather fine, still slightly tapering, the arista as long as the antennal joints combined. (See fig. 2.)

Mesonotum deep green, shining on the posterior half, the ground colour obscured on the anterior half or more by brown pollen, which leaves two darker vittae separated by the rather long and abundant acrostical bristles. Mesopleura bronzed, the remainder of the pleura greenish and greyish pollinose. Scutellum shining green or bronzed with one large and from one to four smaller bristles on either side, the small ones basal and very variable. Propleura brown pilose.

Coxae black with grey pollen, the anterior four with rather abundant black hair, the posterior ones with whitish hair and no black bristle, the middle ones with a strong, the hind ones with a weaker, black thorn. Trochanters and femora black, with thin brownish grey pollen, the front ones with dense brownish pile behind, which becomes quite long apically and with short almost yellowish hair below, but this becomes longer and brown on the apical half. Middle femora with fairly long black

hair below, which is however paler basally, the femora elsewhere with short black hair. Anterior four tibiae black with the apical third reddish in certain lights, the posterior ones reddish in certain lights, the dorsal surface yellowish, with the basal fourth black, the apical fourth or less darkened and sometimes brown; the anterior four bear unusually numerous black bristles on their upper surface, the hairs black. Anterior four tarsi usually blackish from the tip of the first joint, but they may be reddish on the bases of the second and third joints. First joint of the front tarsi not twice as wide at apex as at base, the second three-fourths as long as the first, but little enlarged at apex, the three apical joints sub-equal, the whole tarsus longer than the tibia. First two joints of posterior tarsi sub-equal.

Wings slightly cinereous. Squamae and halteres yellow, the former with abundant black cilia.

Abdomen green, rather thickly greyish pollinose, the incisures, a more or less distinct basal triangle which reaches almost to the apex of each segment and the last two segments, bronze-brown, although the latter are often more or less green in certain lights. Hair black, that on the sides and venter fine, white. Genitalia black, with greyish pollen, the outer lamellae brown, furcate, with fine brownish yellow fringe; the inner lamellae shining brown, very short. For shape see fig. 1.

Female. Face wide, the upper portion almost square, sometimes appearing scarcely longer than wide, but at the antennae usually quite as wide as long, the ground colour evidently blackish, but densely covered with brownish yellow pollen, which is more brown on the upper part. Front bronze-black, rather densely yellowish brown pollinose. Occiput blackish green, with brownish grey or grey pollen, the beard brownish reddish. Palpi black, in some lights pollinose like the face; elongate oval, their hair black. Antennae black, short, the third joint cordately triangular, broader than long, scarcely longer than the first. Arista about as long as the front and face together, the penultimate section thickened and half as long as the width of the third antennal joint. (See fig. 3.)

Mesonotum with the middle line, lateral margins behind the suture, and the posterior depression green, the scutellum of the same colour, and these parts greyish pollinose; mesonotum elsewhere bronzy, covered with moderately abundant brownish grey pollen. Pleura green-black, with bronze and green reflections, covered with greyish pollen. Propleura yellow pilose.

Coxae green, grey pollinose, yellow pilose, the apical half of the middle ones black-haired, the front ones with black marginal hairs

apically. Anterior four trochanters and femora black; posterior femora black with the basal third and the apical half of their trochanters reddish. Tibiae reddish, their bases blackish, the apical fifth of the hind ones brownish at least on the posterior surface; basitarsi yellowish or reddish, except apically, the hind ones darker, the tarsi elsewhere black. Apical bristles of the femora more abundant than usual, and there are several long black hairs apically on or near the lower edge of each, the tibial bristles also more numerous and longer than usual. Tarsi normal.

Wings decidedly tinged with brownish. Squamae with abundant yellow cilia. Abdomen green, greyish pollinose, the incisures bronzed.

Described from nineteen males and eight females collected by Dr. J. M. Aldrich at Tennessee Pass, Colo., 10,240 ft., July 7th to 12th.

Type, allotype and paratypes—Male and female. Cat. No. 28075, U.S.N.M.

Paratypes—No. 645 in the Canadian National Collection, Ottawa.

2. *Rhaphium nigrum* Van Duzee

“Male. Length 4 mm.; of wing 3.7 mm. Face very narrow, black. Palpi black. Front opaque black; eyes with brown hairs. Antennae black; third joint about as long as the two basal joints taken together; arista about equal to the antenna in length. Hairs of the beard mixed black and brownish.

“Thorax black, scarcely at all greenish on the dorsum, which is dulled with brown pollen. Abdomen dark green, the apical segments almost black. Hypopygium black; its outer lamellae very broad at base, forked, one branch wide, short and blunt, the other long, rather narrow and more pointed; they are brownish; inner appendages yellow, black at upper corner, enlarged and truncate at tip, fringed with pale hairs. Coxae black with long black hairs; middle pair with a long black thorn at tip. Femora black, a little yellowish at the tip, fore femora with long black hair on posterior surface; middle femora with long black hair below and three slender bristles on posterior side and one on anterior side at tip; hind femora with long black hair below, which is a little longer towards their tips. Fore tibiae more than half black; middle pair yellowish, blackened on basal half above, four anterior tibiae with strong bristles; hind tibiae dark yellow, scarcely darker at tip, but dark at base, thickened towards the tip, their bristles stout. Fore tarsi one and a fourth times as long as their tibia, black from the tip of the first joint, still the base of the second joint a very little yellow, first joint as long as second, a very little thickened at tip, second joint abruptly narrowed near the base, both these joints with minute blunt

black spines below, the three apical joints of nearly equal length. Middle tarsi with the two first joints yellow, the second half as long as the first (other joints missing). Hind tarsi black, second joint shorter than the first and fifth, only slightly shorter than the fourth. Calypters and halteres yellow, the former with black cilia.

"Wings dark gray, with black veins; third vein considerably but evenly arched; last section of fourth vein only slightly bent near apical third, ending slightly back of the apex of the wing; last section of fifth vein about twice as long as the cross-vein; hind margin of wing nearly evenly rounded.

"*Female*. A female that I think belongs with the male described above, although not taken at the same place or in the same year, has the wings about as in the male, except that they are a little darker with slightly hyaline spot around the cross-vein; the bend in the last section of the fourth vein is a little nearer its centre, but otherwise about the same; it ends just back of the apex of the wing as in the male. The face is gray with the suture near its centre; palpi black with black hairs; beard whitish; front, thorax and abdomen green with grey pollen; coxae with long white hairs. Femora black with yellowish tips; fore femora with long white hair on the posterior surface; middle and hind ones with pale hairs below, the latter with a row of slender black bristles, on lower outer edge; middle femora with two bristles on each side at tip; fore and middle tibiae yellow, hind ones like those of the male, fore and middle tarsi as long as their tibiae, darkened from the tip of the first joint, which is as long as the three following taken together.

"Described from one male taken at Katmai, Alaska, in July, 1917; and one female taken at Savonoski, Naknek Lake, Alaska, in June, 1919." (Original description)

Type in Ohio State University.

3. *Rhaphium boreale* Van Duzee

Male. Length 4-4.5 mm.; of wing, 3.3-4 mm. Face narrow, black. Palpi black. Front green, nearly covered with white pollen. Antennae black; third joint scarcely longer than the two basal joints taken together; arista about as long as the antennae. Beard black, sometimes more brown. Eyes with pale hairs.

Thorax and abdomen green with whitish pollen, the former quite shining. Hypopygium black; its outer lamellae long and narrow, yellowish brown, plain, as long as the height of the hypopygium and

fringed with long pale hairs; the inner appendages very small, black, with a hair at tip.

Coxae black with black hair, the middle pair with a black thorn at tip. Femora black; anterior pair with long black hair on their posterior surface; middle pair with several black bristles on each side near the tip; posterior pair with two preapical bristles. Fore and middle tibiae yellow, the former with two, the latter with three rows of long bristles. Hind tibiae blackish or yellowish brown with a yellow glabrous line on upper surface, and with two rows of rather stout bristles. Fore tarsi longer than their tibiae, darkened from the tip of the first joint, which is about twice as long as the second and a little enlarged at tip; last three joints of about equal length. Middle tarsi black from the tip of the first joint, slightly longer than their tibiae; the first joint nearly as long as the three following taken together, fourth scarcely longer than the fifth. Hind tarsi black, each joint a little longer than the one following it. Halteres yellow. Calypters dark yellow with yellowish cilia, which appear black in certain lights.

Wings greyish; third vein considerably but evenly arched; last section of fourth vein bent near its middle, ending in the apex of the wing; last section of fifth vein scarcely twice as long as the cross-vein; hind margin of the wing rather evenly rounded.

Female. What seems to be the female of this species has the face grey; the suture below the middle, making the lower part of the face small; it is a little pointed at the centre of its lower edge; palpi black, rather small, their tips yellowish, beard white, scanty; fore coxae with yellow hairs, sometimes with one or more black hairs at tip; femora and tibiae yellow; hind femora more or less black at tip or along the upper edge; middle and hind femora with preapical bristles; fore tarsi scarcely as long as their tibiae, the first joint as long as the remaining four taken together; middle tarsi fully as long as their tibiae, first joint as long as the three following joints taken together; hind tarsi black, first and second joints of nearly equal length. Wings grey; slightly brownish in front of second vein; third vein very slightly recurved at tip; last section of fifth vein more than twice as long as the cross-vein.

Described from six males and eight females, taken at Savonoski, Naknek Lake, Alaska, and in June and July, 1919, and two males taken at Katmai, Alaska, in July, 1917, and two males taken by J. M. Aldrich at Anchorage, Alaska, July 20, 1921. (Van Duzee, Ohio Jour. of Sci., XXIII, 246, 1893)

Paratypes—Males, Cat. No. 28094, U.S.N.M.

4. *Rhaphium vanduseei* new species
(Figs. 4, 5).

Length 5 to 5.5 mm. Face black; beard chiefly black; prothorax pale pilose; front coxae black pilose; anterior four femora blackish on basal two-thirds, the hind ones yellow except the apical fourth or less; genital lamellae branched.

Male. Face very narrow (eyes narrowly separated), wider above and below, brown or black; front bluish or green blue, moderately whitish pollinose. Occiput green, thickly greyish white pollinose; the black orbital cilia extend almost to the middle of the eyes and much below the level of the antennae; beard black, but yellowish around the neck. Palpi dull black, the margins sometimes appearing greyish, the few hairs black. Antennae black, the third joint tapering, large, as long as the front, the arista as long as the face, its basal section over twice as long as wide, swollen. (See fig. 5)

Mesonotum green-blue, thinly brownish pollinose on more than the anterior half, with broad bare stripe (outside the acrostical bristles) which is somewhat darker. Pleura green and black-green, covered with greyish pollen. Prothorax whitish pilose.

Coxae blackish, grey pollinose, their pile black, yellowish on the hind pair, the middle ones with a moderately short, rather loose thorn. Trochanters brown. Anterior four femora black, their apical third reddish; posterior ones yellowish with the apical fourth or fifth brownish, the latter colour less extensive below. The anterior femora bear long black hair on the posterior surface and a row of similar hairs on the apical half of the antero-ventral surface, the preapical bristles not distinguishable. The middle femora bear a row of long pale hairs on less than the basal half below, some of which are longer than the width of the femora and directed somewhat basad; beyond these are several shorter, stronger apically directed hairs, and on the postero-ventral surface three or four long bristly hairs, the anterior surface with two widely spaced preapical bristles. The hind femora bear rather long, erect hair on the basal half of the anterior surface above, and one small anterior preapical bristle. Tibiae yellowish, the apical fifth of the posterior ones blackish. Tarsi black or brown, the basal two or three joints of the front four yellowish, their apices somewhat infuscated or not, or all the joints of the tarsi may appear somewhat reddish or yellow basally, as in the paratype. The first joint of the front tarsi is swollen apically, the second joint three-fourths as long, the third as long as the last two.

Wings brownish hyaline, the cross-vein oblique. Squamae and halteres yellow, the former white ciliate.

Abdomen green, thinly greyish pollinose, the sides more thickly so, the incisures blackish-bronzed. Hair black, on the sides and venter white. Genitalia black, the outer lamellae brownish with fine brown hairs; wide basally, constricted before the middle where there is a short arm; inner lamellae long and slender, brownish. (See fig. 4)

Female. Face rather narrow for a female, argenteous, the upper section at least one and one fourth as long as wide. Front green, densely greyish pollinose. Occiput densely greyish pollinose on green ground, the beard whitish. Palpi brown, reddish apically, but thickly greyish pollinose, their hair black. Antennae black, the third joint subcordate, but little longer than wide; arista as long as the face.

Anterior coxae reddish yellow, their pile white, but there are several black bristles on the apical margin exteriorly. Posterior four coxae mostly blackish but with reddish reflections in large part, the middle ones with yellow pile and several black apical bristles, the hind ones with white hair and no bristle. Legs reddish yellow, the tibiae paler, the apex of the posterior tibiae and the tarsi as in the male, the basitarsi simple. The hair on the anterior femora is somewhat longer than usual, and there is one preapical posterior bristle, the hairs below this noticeably strong; middle femora normally with an anterior and two postero-ventral preapical bristles, the hind femora with a small anterior one.

Described from three specimens from Lafayette, Ind., May 24 and August 7 and 14 (Aldrich).

Paratype—♂, May 24, 1917; No. 649 in the Canadian National Collection, Ottawa.

Type and Allotype—Male and female, Cat. N.o 28076, U.S.N.M.

5. *Rhaphium nudum* Van Duzee

(Figs. 6, 7).

Length 4.5 to 5 mm. Face and beard black; genital lamellae with a short median branch; legs black, the front four tibiae and hind ones except the tip, yellow; coxae without spine.

Male. Face very narrow, slightly widened above, opaque black. Front deep green, rather thickly dark brown pollinose. Occiput deep blue green, thinly greyish brown pollinose, the beard black. Palpi black, with brownish tips, small, their strong hairs black. Third antennal joint

slightly longer than the front, rather strongly tapering, the arista longer than the face. (See fig. 7)

Mesonotum deep green, becoming watery blue-green behind, with a dark vitta on either side of the middle line; thinly brownish pollinose. Pleura largely blackish; greyish pollinose. Propleural pile black.

Coxae blackish green, grey pollinose, wholly black-haired except on the outer side of the hind ones which bear yellowish tinged fine hairs. No coxal spines. Femora, apical fourth or less of hind tibiae, hind tarsi, last three joints of front four tarsi and apices of the first two joints, blackish or brown; apices of the femora, tibiae and bases of first two tarsal joints, reddish, but in some specimens they are only reddish brown. First two joints of the front tarsi broadened and thickened apically, the second not much shorter than the first, the apex of the first joint and whole of the second with noticeably developed longer black bristly hair on the anterior surface. Femora wholly black-haired, the bristles on tibiae more numerous than ordinarily.

Wings somewhat cinereous; cross-vein straight, oblique. Squamae and halteres yellow, the former with abundant yellow cilia. Abdomen green basally and laterally, greyish pollinose, the disc and last two or three segments bronzed. Genitalia (fig. 6) black, the lamellae brown, with fine, short, brown hair. Pile of sides of abdomen yellow, of venter white, the dorsal hairs black.

Female. Face wide, the upper section almost square, the lower a little longer than wide or equal, and about as long as the upper; brownish golden pollinose. Front deep bronze green, the colour chiefly obscured by grey-brown pollen. Occiput rather bright grey-green, greyish pollinose, the beard yellowish. Palpi large, brown, black-haired, their pollen similar to that on face. Third antennal joint subcordate, as wide as long; arista situated at apex, almost as long as face and palpi.

Propleural pile yellowish, that on the coxae similar; the anterior coxae broadly, obscurely reddish on anterior apex. Legs reddish, the hind femora more or less brownish above on apical half, their tibiae and tarsi as in male, the other tarsi coloured as in male, simple in structure. Anterior femora with two or three fine preapical bristles in row on upper edge, the hind ones with a median one on anterior surface, the middle with two anterior and two or three posterior preapical bristles.

Description from numerous specimens from Ottawa, Ont., and Hull, Que., June. Originally described from Fairbanks, Alaska.

This is one of the several species of Dolichopodidae which I have taken commonly near Ottawa and which Van Duzee has described from

Alaska. It is probably the most common species in the genus in the vicinity of Ottawa, and I took well over fifty specimens in less than fifteen minutes near Hull in a shaded gully with extensive mud beds. It was possible to take a score or more at each sweep of the net over the mud. Both sexes are readily recognized, the female by the unusually brownish golden face.

Type—Cat. No. 25960, U.S.N.M.

6. *Rhaphium terminale* Van Duzee

(Figs. 8 and 9).

Male. Length 4.5 mm. Face very narrow, black. Palpi and proboscis black. Front usually steel blue, sometimes green, not very bright. Antenna (fig. 9) black; third joint scarcely more than half as long as the face; arista nearly twice as long as third joint. Hairs of the eyes brown. Beard black, abundant.

"Thorax green, rather dull, its posterior slope and the scutellum usually steel blue, the latter with two pair of marginal bristles, the outer pair half as long as the median ones. Abdomen green, the last two segments usually more purple; hairs on its dorsum black, those on the basal edge of first segment and the long ones on the sides of first and second segments yellowish; venter black, its hairs white. Hypopygium (fig. 8) of moderate size, black; its outer lamellae long, tapering, ribbon-like, brown, fringed on the edge and one side with long pale hairs; inner appendages a little paddle-shaped, testaceous, with four minute spines near the middle on one edge.

"Coxae wholly black, anterior pair shining on posterior surface, the anterior half dull with black hairs, those along the outer edge of anterior side pale; middle and hind coxae with pale hairs, the former with a black thorn at tip. All femora black, fore and middle ones with yellow tips; outer surface of fore femora with long black hair above and a row of slender black bristles below; there are a few long pale hairs between these bristles and the black hair above. Middle femora with a few pale hairs at base below and three long, slender, black preapical bristles on posterior side and one on anterior side; hind ones with one very small preapical bristle, their hair short, except a few longer hairs at base above. Fore and middle tibiae brown at base, apical half yellow, their bristles long, middle ones with a row of four bristles on lower anterior edge. Hind tibiae black at base and tip, still mostly yellowish, sometimes only the extreme base infuscated, their bristles rather strong. Fore tarsi a little longer than their tibiae; first joint a little enlarged

at tip and extending beyond the base of second joint, which is slightly compressed, except at tip, of about equal width, three-fourths as long as first; fourth and fifth of about equal length and taken together about as long as third. Middle tarsi black from the tip of the first joint, still sometimes the second is yellowish at base. Hind tarsi wholly black, with the first and second joints of about equal length. Calypters, their cilia, and the halteres pale yellow.

"Wings grayish, veins brown or yellowish; third vein bent backward; at tip it is a little recurved forward; last section of fourth vein bent beyond its middle, nearly parallel with third towards its tip, ending in the apex of the wing; last section of fifth vein nearly one and one-third times as long as the cross-vein.

"*Female*. Face broad, its pollen coarse and yellowish; suture near the centre of its length, lower portion with oral edge rounded, and with the metallic green ground colour showing through the pollen. Antennae small, third joint not longer than wide. Beard white, rather abundant on the sides. Thorax with the posterior part of the dorsum more or less coppery red. Hairs on the dorsum of the abdomen mostly whitish, those on the sides of first and second segments moderately long, white. Fore coxae with white hairs. Fore femora black or green with their tips broadly yellow, and sometimes yellow below, their posterior surface with rather long white hair and several small black bristles near the tip. Middle and hind femora yellow, the latter more or less blackened at tip, at least above, and with one small preapical bristle; middle ones with two or three preapical bristles on each side. All tibiae yellow; posterior ones blackened a little at base and tip; middle ones with two bristles on anterior surface. Fore tarsi as long as their tibiae, darkened toward their tip, last joint black, second joint a little more than half as long as first, last three joints of about equal length, still the fourth a little the shortest. Middle tarsi blackened from the tip of the first joint, which is as long as the three following taken together; fourth shorter than fifth. Hind tarsi wholly black, first and second joints of equal length.

"Described from seven males and seven females, Alaska."

Type—Male, Cat. No. 25959, U.S.N.M.

"This species has the appendages of the hypopygium very much like those of *elegantula* Meigen, but it is smaller, duller, the legs are much more blackened, and the hair on fore coxae is mostly black in this form, while in *elegantula* it is whitish; they also differ in other points." (Van Duzee)

In the Canadian National Collection there are two paratypes, ♂ ♀ donated by the United States National Museum.

7. *Rhaphium banksi* Van Duzee new species

(Figs. 10, 11)

The manuscript for this species has been prepared by Mr. M. C. Van Duzee.

Male. Length 4.7 mm. Face narrow, silvery white. Palpi white, small. Front green with white pollen. Antennae black; third joint as long as the face, tapering to a point; arista apical, as long as the antenna. (See fig. 11.) Beard white, abundant; the black orbital cilia descend to upper third of the eye.

Thorax dark green, shining; scutellum with one pair of marginal bristles. Abdomen green with black incisures, its sides dulled with white pollen; hairs on the abdomen pale, except a very few on the hind margins of the segments along the middle of the dorsum; the hairs on the sides long and white. Hypopygium black with green reflections, the outer lamellae (Fig. 10) large, brown with a black border and black dots where the hairs are inserted, they are broad, somewhat triangular, tapering to a point at lower outer corner, fringed with black hairs; the inner appendages are a pair of small but rather long, dark, slightly clavate organs, and the central filament has its tip large and truncate at apex.

All coxae blackish with long white hair and bristles; middle pair without a thorn at tip. All femora black; anterior pair with long white hair on their posterior surface; middle ones with long white hairs on lower posterior surface; hind ones with long white hair on upper edge of basal half. Fore and middle tibiae yellow, the latter more brownish. Hind tibiae wholly black. All tarsi black or dark brown; middle basitarsi with a few spines below at base; joints of fore tarsi as 33-13-7-5-7; those of middle ones as 42-23-18-7-7; joints of hind pair as 37-34-22-13-9. Calypters yellow with a brown tip and white cilia. Halteres yellow.

Wings tinged with brown in front of third vein, which is bent backward at tip; last section of fourth vein considerably bent, parallel with third at tip; last section of fifth vein not quite twice as long as the cross-vein.

Described from one male taken at Dyke, Va., May 14, by Nathan Banks, for whom the species is named.

Type in the Van Duzee collection.

8. *Rhaphium albibarba* Van Duzee

(Figs. 12, 13).

"*Male*. Length 4 mm.; of wing the same. Face narrow, silvery white. Palpi velvety black, edged with white pollen, and with a few small black hairs. Front steel-blue, dull. Antennae black (fig. 13); third joint about as long as the face, rather slender toward the tip; arista slightly more than half as long as the antenna, its first joint short. The long black orbital cilia reaching down to upper fourth of eye height, below these the long, dense beard is sordid white.

"Thorax blue-green, dulled with gray pollen; dorsum with the usual brown stripe on each side of the acrostical bristles; scutellum with one pair of long bristles, two pairs of small ones between them, and three pairs of long hairs basally on its margin, and two small black hairs on the disk; propleura with long white hairs. Abdomen metallic green, dulled with gray pollen, hairs on the dorsum black, those on the sides of the first three segments and extending on to the dorsum of first are yellowish and on the lower edge long and dense. Hypopygium (fig. 12) black, rather small, upper half dull, lower part shining; outer lamellae triangular, black, fringed with long pale hairs, they are scarcely as long as the height of the hypopygium; inner appendages long and shining black, pointed, extending forward under the abdomen; they have several delicate hairs on upper surface.

"Coxae, legs and feet wholly black, except tip of fore tibia, apical half of middle tibia and base of fore and middle basitarsi, which are yellowish. All coxae with long whitish hair, that on the anterior pair very dense; middle pair with a thorn of black bristles at tip. All femora fringed with long whitish hairs on lower posterior surface, those on middle pair not so numerous but on the others very abundant; posterior ones also have besides those already mentioned a few pale hairs on lower outer edge ending with one or two black ones and with a small black preapical bristle. Tibiae with numerous bristles on upper surface, those on posterior ones more scattering. Fore tarsi as long as their tibiae, first joint as long as the three following taken together, second, third, and fourth each a little shorter than the preceding one; fourth, and fifth of about equal length; fore basitarsus considerably enlarged below at tip. Hind tarsi stout, scarcely as long as their tibiae, first and second joints of equal length. Calypters and stem of halteres brownish, cilia of the former whitish, knobs of halteres yellow.

"Wings tinged with brownish gray, darkest in the middle of the cells, a hyaline spot surrounds the cross-vein and extending somewhat at its middle; third vein bent at about the same distance from its tip

along the upper edge of the fifth vein; last section of fourth vein bent so as to approach fourth and about parallel with it near their tips, fourth ending in the apex of the wing; first vein reaching about half the distance to the cross-vein; last section of fifth vein twice as long as the cross-vein.

"Described from one male taken at Anchorage, Alaska, July 21.

"*Type*—Male, Cat. No. 25961, U.S.N.M." (Original description)

I have not seen this species. The wings evidently are somewhat as in *campestre* Curr., but the almost wholly black legs will at once serve to distinguish the species.

9. *Rhaphium armatum* Curran

(Figs. 14, 15).

Length 5 mm.; antennae 1.25 mm. *Male*. Face as wide as the first antennal joint, slightly wider above, densely silvery white pollinose. Front green, the ground colour largely obscured by white pollen so that it only shows weakly above, the anterior margin and sides below blackish. Occiput green, slightly brassy or bronzed, narrowly white pollinose on lower three-fourths along the orbits; upper cilia black, the beard white, not dense. Antennae black, third joint as long as height of head, gradually tapering from its base, very short pubescent; arista slightly longer than first two antennal joints. (See fig. 15.) Palpi black, white pollinose in front, where there are also a few white hairs; proboscis blackish.

Mesonotum rather blackish green, not brilliantly shining, with two approximate bronzed stripes on the middle line; the sides before the base of the wings whitish pollinose. Pleura with two or three paler green areas, but generally blackish green, with moderately abundant whitish pollen.

Coxae, femora and posterior tibiae and tarsi, black or green, the apices of the trochanters and extremely narrow bases of the femora, yellow; apices of front four femora, their tibiae, first four joints of middle tarsi and the anterior basitarsi, except the apex, yellowish, joints of middle tarsi infuscated apically, the front tarsi brownish. Coxae entirely white-haired, no black bristles; legs with short, appressed black pile except white hair as follows: behind the front femora, where it is abundant, behind the middle femora, where it is long and moderately abundant; a few long hairs at the base of the posterior ones on the upper surface. Middle femora with one or two preapical bristles on front surface and two on posterior surface. First joint of front tarsi incrassate apically,

the posterior femora increased in width from the slender base almost to the apex. Middle coxae with strong black thorn, posterior coxae lacking one.

Wings slightly fuscous, more so in front. Squamae yellow, with white cilia. Halteres yellow, the stem short and slightly fuscous.

Abdomen brassy green, the incomplete bases of the segments bronze-black on basal half or less, the fifth segment almost all this colour, the sixth segment more blackish. Pile black, moderately long, on the sides longer, white. Genitalia black; outer lamellae short, rather narrow, fuscous, with short yellow marginal hair apically; inner lamellae as long as the outer, sharply curved away from the body near their apex, at the point of the curve sending forward two slender filaments, which curve sharply upwards, then again forwards to end in a fine acute point; these lamellae are black as far as the curve, thence bright yellow. (See fig. 14)

This species is difficult to place. It has the aspect of *P. melampus* Lw., but shorter genitalia and longer hind legs; still the antennae indicate relationship to *melampus*. The long legs place the species near *crassipes*, *canadense*, etc.

Originally described from Quebec and New York.

Type in Canadian National Collection.

Paratype—Male, Cat. No. 28077, U.S.N.M.

10. *Rhaphium barbipes* Van Duzee

Ent. News, XXXIV, 239, 1923.

“♂. Length 5.3 m.m. Face narrow, silvery white; front green. Antennae black; third joint nearly as long as the face; arista as long as the antennae. The long white beard abundant and reaching the upper fourth of the eye, the upper orbital cilia short, black.

“Thorax green, shining with a spot of white pollen on each side extending from the humeri to the suture and a blackish spot above the root of the wing; scutellum with four marginal bristles.

“Abdomen green, apical segments almost black, spots of white pollen and long white hair on the sides. Hypopygium not very large, its outer lamellae as long as the height of the hypopygium, curved, of equal width, not tapering, fringed with pale hairs; inner appendages not quite one-third as long as the outer, straight, blunt, divergent.

“Coxae, femora, hind tibiae and hind tarsi black. Coxae with long white hair, middle and hind pairs with a black thorn at tip; tips of fore and middle femora and their tibiae yellow. Fore femora on

posterior surface, middle pair below and hind ones on anterior surface with abundant, long, white hair. Fore tarsi yellow, infuscated towards their tips, first joint slightly compressed, a very little hollowed below beyond their middle and with a row of about seven blunt teeth on the middle of lower edge; joints of fore tarsi as 37-17-13-8-8. Middle tarsi black from the tip of first joint. Joints of hind tarsi as 48-37-16-15-15. Calypters and halteres yellow, the former with white cilia.

"Wings very slightly tinged with brown; third and fourth veins approach each other a little but are parallel towards their tips.

"♀ Two females that seem to belong with this male have the face wide, white, rounded below, its suture below the middle; third antennal joint about half as long as in the male; beard not conspicuous, except on lower part of the head; coxae, fore and hind femora, and posterior tibiae and their tarsi black; all trochanters, entire middle femora and the first joint; middle tarsi mostly blackish; wings as in the male, still more tinged with brown.

"Described from one pair (male *holotype*, female *allotype*) taken at Machias, Maine, July 21 and 22; and one female found at Princeton, Maine, July 12; all were taken by C. W. Johnson and are in the collection of the Boston Society of Natural History." (Original description)

11. *Rhaphium orientale* new species

(Figs. 16, 17)

Allied to *barbipes* Van Duzee from which it evidently differs only by the outer genital lamellae being clothed with long, coarse black hairs instead of yellow hairs.

Length 6 to 6.5 mm. *Male*. Face long, narrow, a little widened above, silvery white, brownish just at the antennae. Front rather narrow, deep green, thinly greyish pollinose. Occiput greyish or whitish pollinose, blackish between the orbital bristles and eye margins; beard abundant, white; eyes emarginate at upper fourth, yellow pilose. Palpi black, with ochreous pollen in some lights, their fine hairs pale. Third antennal joint three times as long as wide, tapering; antenna hardly twice as long as third antennal joint. (See fig. 17)

Mesonotum deep green, mostly with bronze reflection, the median and sub-lateral vittae clearly green. Notopleura and pleura greyish pollinose. Propleural pile white. Acrostical bristles strong, reaching the posterior fifth of the mesonotum. Scutellum with four strong bristles.

Coxae black or green, grey pollinose, white pilose; posterior four coxae with thorns; posterior coxae with black bristle among the pale hairs on the outer surface. Femora black, the apices of the anterior four reddish. Anterior four tibiae and basal joint of their tarsi, reddish yellow, the legs elsewhere black or brown, although the bases of the joints of the front tarsi are usually somewhat reddish. First joint of front tarsi hardly three-fourths as long as the remaining joints, on the anterior lower margin with a row of short, stout spinules not reaching the base or apex, behind with six or seven similar spinules on the slightly swollen apex and with several longer finer hairs towards the base. Anterior four femora with long whitish hair behind, and below, the anterior pair with short white hairs on the lower anterior edge; posterior femora with long whitish hair in front except apically. Anterior femora without preapical bristles, the middle ones with two or three in front and behind towards the lower edge, the posterior pair with a row of six to eight black cilia on apical third of each of the lower edges and with three or four black bristles on the anterior surface before the apex.

Wings tinged with brownish or luteous. Squamae and halteres yellow, the former white ciliate.

Abdomen green, the bases of each segment, expanded in the middle, bronze black, the apical segment wholly of this colour, the paler areas greyish pollinose. Sides of abdomen and venter with whitish pile. Genitalia black, lightly greyish pollinose; outer lamellae brown with stout black hairs. (Fig. 16)

Female. Face with parallel sides, rather narrow for female; front often almost black; palpi large, sub-triangular, black, with silvery grey pollen which has a slight brownish reflection, the hairs black. Third antennal joint twice as long as wide, tapering; arista one-fifth longer than face.

Anterior coxae with several black bristles apically; middle coxae with an apical fringe of strong black bristles, the hind ones similarly armed. Legs coloured as in male, the hind femora without white hair and with much shorter cilia below.

Described from 4 ♂ and 8 ♀, Barber Dam, New Brunswick, June 25, 1914, (J. D. Tothill); and 1 ♀, Oromocto, N.B., July 9, 1913; 1 ♂ New Bedford, Mass., May 31, 1896, (Hough).

Type and Allotype—No. 1352 in the Canadian National Collection, Ottawa.

Paratypes—Male and female, Cat. No. 28078, U.S.N.M.

12. *Rhaphium spinitarsis* Curran

(Fig. 18).

Length 4 mm. Femora black, face moderately narrow, silvery white; middle basitarsi with several long black bristles below, anterior four tibiae wholly yellow, the hind ones black with the basal two-thirds pale yellow above.

Male. Face moderately narrow, with nearly parallel sides, slightly widened on upper third; silvery white. Front green to black green, bare. Occiput green, very thinly whitish pollinose. Beard yellowish. Palpi black, with brownish yellow anterior margin, the hairs black. Antennae black, the third joint twice as long as wide, acute (not as long as the face); arista as long as the face, its penultimate joint about twice as long as wide, swollen.

Mesonotum green, usually almost all bronzed, with a dull bronze line outside the acrostical bristles. Pleura green and bronzed, grey pollinose. Prothorax yellowish pilose.

Coxae green or black, grey pollinose, with yellowish pile, middle coxae with a long, slender black thorn, and a black bristle on the outer margin towards the end, the posterior ones without bristle. Coxae, femora, posterior tibia and tarsi, black, the posterior tibiae yellowish on the basal two-thirds of their dorsal surface. Anterior femora with moderately long black hairs behind, below with long pale hairs on more than the basal half, the middle ones with pale hairs below on basal half, and very long pale hairs on basal third of the postero-ventral surface. Front femora with posterior, middle with one anterior and posterior, the hind with anterior preapical bristle. Anterior four tibiae pale yellowish. Anterior four tarsi black from the tip of the first joint; anterior basitarsus gradually very slightly thickened to apex, but not conspicuously enlarged, the three following joints very strongly compressed and much higher than wide, the hair conspicuous on the basitarsi. Middle basitarsi (fig. 18) with three unusually long bristles on the basal fourth below, and a smaller one just before the middle.

Wings brownish tinged, with cross-vein almost rectangular. Squamae and halteres yellow, the former with white cilia.

Abdomen green, with bronze reflections, thinly greyish pollinose, the sides evidently only a little more so. Hairs black, on the sides and venter yellowish. Genitalia black; outer lamellae brown, with black hairs, the inner shining black.

Originally described from Manitoba and Colorado. Occurs also in Alberta.

Type in Canadian National Collection.

Paratype—Male, Cat. No. 27525, U.S.N.M.

13. *Rhaphium johnsoni* Van Duzee

Ent. News, XXXIV, 240, 1923.

"*Male*. Length 5-5.5 mm. Face narrow, silvery white. Front shining green. Antennae black; third joint about as long as the height of the front; arista apical, a little longer than the antennae. Beard long, abundant, white; upper orbital cilia black, rather short.

"Thorax dark shining green; scutellum with four large marginal bristles. Abdomen green, its incisures black or bronze, hairs on its dorsum black, those on the sides and venter long and white. Hypopygium black, not very large; its outer lamellae rather short, black, of about equal width to the tip, which is somewhat truncate; inner appendages small.

"Coxae black with long white hair, middle pair with black bristles at tip, these do not form a thorn. Femora black, fore and middle pairs with yellow tips, the former with long white hair on posterior surface; middle ones with long white hair on both anterior and posterior edges below. Hind femora with rather long, black, stiff hairs on outer surface and lower inner edge. Fore and middle tibiae and most of their tarsi yellow. Hind tibiae and tarsi wholly black. Joints of fore tarsi as 37-11-9-4-10; of hind tarsi as 40-37-25-11-12. Calypters and halteres yellow, the former with white cilia.

"Wings grayish; third and fourth veins bent so as to approach each other a little, but parallel towards their tips; last section of fifth vein as long as the cross-vein.

"*Female*. A female that seems to belong with these males has the antennae very nearly like the male's; face wide with its sides parallel, rounded below, its suture just above lower third; the white hair forming the beard, on the coxae and on the fore and middle femora much shorter than in the male, the black hair on the hind femora also short.

"Described from three males and one female. The *holotype*, a male, was taken at Lahaway, Ocean Co., New Jersey; the female (*allotype*) was taken by Nathan Banks, at Falls Church, Virginia, May 16; one of the other males was taken at Jeffrey, New Hampshire, June 18, and the other at Kingston, Rhode Island, June 17, by C. W. Johnson. Holotype and allotype in the author's collection."

14. *Rhaphium caudatum* Van Duzee, new species

(Figs. 19, 20).

The manuscript for this species has been prepared by Mr. M. C. Van Duzee.

Male. Length 4 mm. Face narrow, silvery white. Front dark green. Palpi black with a little white pollen, nearly as long as the width of the base of the third antennal joint. Antennae black, third joint more brown, nearly as long as the height of the head; arista apical, one third as long as the third antennal joint. (See fig. 20.) Orbital cilia and the rather long beard white.

Dorsum of thorax dark blue-green, quite shining; pleura more black with white pollen. Scutellum with four marginal bristles, the outer pair much the smallest. Abdomen green with a few black hairs on the dorsum and white hair on the sides and venter. Hypopygium (fig. 19) black or dark brown with short black bristles at the end; outer lamellae black, small, hairy, inner appendages larger, black and formed as follows—a broad stem with a transverse, curved bar at the end, this bar extends posteriorly as a short, bare, curved horn, and anteriorly in a long, curved, forked appendage with a few hairs on the side, one of its forks slightly enlarged at tip and fringed with stiff little hairs, the other branch is somewhat yellowish, thin and narrower, terminating in four hairs; penis yellow, short and blunt (in the paratype all these appendages are less conspicuous, being more closely drawn up to the hypopygium).

Coxae, femora, hind tibiae and their tarsi black. Fore and middle coxae and posterior surface of anterior femora with long white hair. Middle coxae with a black thorn at tip; the posterior pair also have a slender thorn. Middle femora with a few white hairs on lower posterior surface, hind femora with a few long white hairs at base above. Fore and middle tarsi yellow, but with the tips of some of their joints blackened; first joint of fore tarsi slightly enlarged at tip; joints of fore tarsi as 29-12-9-7-7; of middle ones as 48-23-18-12-8; those of hind tarsi as 42-41-27-18-10. Calypters and halteres yellow, the former with white cilia.

Wings greyish, a little tinged with brown; venation about as usual in the genus; last section of fifth vein fully one and a half times as long as the cross-vein.

Described from two males which I took in 1909, the *holotype* at Colden, N.Y., May 23, and the other at Toronto, Ont., May 30.

Types in the author's collection.

15. *Rhaphium discolor* Zetterstedt

(Fig. 21).

Male. Vertex and frons aeneous green, somewhat pruinose; eyes pale-hairy. Epistoma narrow, silvery white. Palpi blackish. Occiput green, a little greyish pruinose; postocular hairs black above, whitish yellow below. Antennae black, almost as long as the head, the third joint about twice as long as the two basal; arista shorter than the antennae. Thorax dark green or somewhat olive, a little greyish pruinose, shining; there are a pair of faint, darker stripes in the middle. Pleura green, greyish pruinose, most behind; propleura with pale hairs. Abdomen green or a little aeneous or coppery, with narrow, dark incisures, slightly greyish pruinose; it is clothed with short, black hairs, longer and pale at the sides of the three first segments; there are hind marginal bristles, somewhat long on the first segment. Venter greenish, grey pruinose, with white hairs, which are long towards the base. Hypopygium (Fig. 21) blackish, the ventral lobes of moderate length, lancet-shaped, pointed with the apex curved a little downwards; the outer lamellae not long, triangularly dilated at the apex with the angle dorsally; they are brownish, short-haired at the margin. Legs with the coxae grey; femora black, the anterior with the apex yellow, the front femora somewhat metallic green; tibiae yellow, or the hind tibiae often darker to dark brown, and blackish at the apex; anterior tarsi blackish towards the end, hind tarsi more or less dark to quite black; the first joint of the front tarsi about as long as the second, slightly dilated below towards the apex; the second a little dilated at the base, the three last short; middle femora thin, middle metatarsus almost as long as the four following joints; hind metatarsus as long as the second joint. The legs have short, black hairs; the coxae are pale-haired; front femora with a row of strong, black bristles below, and with longish, white hairs on the posterior side, the upper row of which are black; middle femora with long, white hairs on the basal half below, and with black bristles at the apex on both sides; hind femora with one or two preapical bristles; tibiae with two dorsal rows of bristles, longest on the anterior tibiae, middle tibiae besides with two antero-ventral and some small ventral bristles; front metatarsi short-ciliated above and below, the second joint above; middle metatarsus with small bristles below, longest at the base. Wings almost hyaline; veins black, discal vein with a small, even curve. Squamulae yellow, with a white fringe. Halteres pale yellow.

Female. Frons aeneous. Epistoma broad, brownish; palpi large,

brownish grey. Antennae short, the third joint about as long as the two basal; arista not twice as long as the antennae. Legs with the femora yellow and quite short-haired; front tarsi simple, the first joint about as long as the two next, the middle metatarsi about of the length of the three next; anterior coxae with no black hairs at apex. Wings somewhat brownish tinged.

Length 3.8–4.7 mm. (Lundbeck)

Coquillett and Van Duzee have recorded this species from Alaska. The above description is copied from the English edition of Lundbeck's *Diptera Danica*, Part IV. Lundbeck describes the species as *Porphyrops consobrina* Zett.

16. *Rhaphium brevilamellatum* Van Duzee, new species

(Figs. 22, 23)

The manuscript for this species has been prepared by Mr. M. C. Van Duzee.

Male. Length 5 mm. Face narrow, silvery white. Palpi black. Front green, dulled with white pollen. Antennae (fig. 23) black; third joint about three times as long as wide and twice as long as the basal two joints taken together. Arista apical, about as long as the antenna. The black orbital cilia rather strong, reaching below the middle of the eye; beard white, abundant.

Dorsum of the thorax and abdomen shining green, the latter with bronze reflections and black incisures; prothorax with white hair above the fore coxae; scutellum with one pair of large marginal bristles and outside of these, but rather close to them, is a pair of small bristles. Hypopygium (fig. 22) black; its outer lamellae brown with a short stem terminating in a nearly round lamella, which is fringed with a few short hairs; inner appendages longer than the outer, somewhat spear-shaped, pointing at tip, with a short stem.

All coxae black, without thorns at tip; fore coxae with long white hair on anterior surface, middle and hind ones with rather sparse white hairs. Fore and middle femora black with apical fourth yellow, the former with long white hair on the posterior surface and black bristles below, which are as long as the width of the femora; middle pair with a few white hairs below. Hind femora black on whole lower surface and apical half above, the basal half above being brownish yellow. Hind tibiae moderately enlarged apically; bristles of the tibiae strong, those of the posterior pair not as long as the others; fore and middle tibiae yellow, posterior pair black, a little yellowish above on basal three-fourths.

Fore tarsi almost wholly yellow, first joint not enlarged at tip; middle tarsi yellow with extreme tips of the joints brown; hind pair wholly black; joints of fore tarsi as 24-18-7-5-7; of middle ones as 42-21-13-12-8; and of hind ones as 40-38-25-15-10. Calypters, their cilia and the halteres yellow.

Wings greyish; tip of third vein bent backward; last section of fourth vein a little arched, almost parallel with third; last section of fifth vein about one and a half times as long as the cross-vein.

Described from two males taken by W. L. McAtee, at Mt. Vernon, Va., July 4, 1917.

Type—Male, Cat. No. 28092, U.S.N.M.

Paratype—Author's collection.

17. *Rhaphium brevicornis* Van Duzee

Ent. News, XXXIV, 241, 1923.

Male. Length 4 mm. Face rather wide above, narrow below, silvery white. Front green, dulled with grey pollen. Antennae black; third joint scarcely longer than wide at base, conical; arista apical, about twice as long as the antennae. Beard sordid whitish, not very abundant for the genus; the black upper orbital cilia extend down to about upper fourth of eye height; there is only one pair of postvertical bristles.

"Thorax green, dulled with brownish pollen and with a brown stripe on each side of the acrostichal bristles.

"Abdomen green, with a few white hairs on the sides, that are longest on first segment. Hypopygium black; its outer lamellae are long, narrow, brown, ribbon-like, of nearly equal width throughout, fringed with pale hairs on one side, if stretched out they would nearly reach the ventral edge of second segment; the inner appendages are a pair of straight organs, slightly widened at tip and reaching the ventral edge of fourth segment.

"Coxae and femora black, tips of the latter narrowly yellow. Fore and middle coxae with long sordid whitish hair, middle ones without a thorn at tip. Fore femora with long delicate white hair on posterior surface, middle pair with only short hair. Tibiae yellow, hind pair black at tip, the black shading into the yellow and reaching to or beyond the middle on posterior side. Fore and middle tarsi yellowish, darker at tip, the former just equal to their tibiae in length, their joints as 28-13-12-9-9, first joint a little widened at tip below. Fore tibiae with rather long hair on lower surface. Middle tarsi with their joints as

32-23-15-10-9. Hind tarsi wholly black, their joints as 40-55-20-14-9. Calypters and halteres yellow, the former with white cilia.

"Wings tinged with brown; third and fourth veins slightly arched so as to approach each other, being nearest together at tips; last section of fourth only a little arched, without a distinct bend; last section of fifth vein twice as long as the cross-vein.

"*Female*. Face very wide, yellowish white; front nearly opaque with brown pollen. Antennae as in the male; thorax dulled with brown pollen, the brown stripes can scarcely be traced, but the central band has less pollen. Coxae blackish with very short pale hairs; fore femora yellowish on anterior, black on upper and posterior surfaces; middle femora wholly yellow, still the upper edge is dark; hind femora yellow with the tip black above; tibiae yellow, hind pair with apical two-fifths black and slightly black at extreme base; tarsi coloured about as in the male.

"Described from two males and one female, taken by Mr. Cole at Hood River, Oregon, the males on June 2 and the female on April 21. Types in the author's collection." (Original description)

18. *Rhaphium nigrovittatum* new species

(Fig. 24).

Length 4 mm. Face and beard white; femora black, coxae blackish, without thorn; third antennal joint not over one and one-half times as long as wide; mesonotum green, with four brownish black vittae.

Male. Face rather narrow, slightly widened above, silvery white. Front dark green, almost blackish, rather thickly greyish pollinose. Occiput green, greyish pollinose, orbital cilia black, beard white. Palpi blackish, their apices broadly reddish, grey pollinose. Third antennal joint about one and one-half times as long as wide; arista as long as the face, its basal section almost twice as long as wide, thickened on apical half.

Mesonotum green, with broad median and sub-lateral bronzy or brown-black vittae, the median one narrowly interrupted for its whole length, all of them rather entire; they vary slightly in width. Pleura dark green, greyish pollinose. Propleura with white pile.

Coxae greenish, greyish pollinose, their apices more or less broadly reddish, their pile white, rather abundant. Trochanters brownish. Femora blackish brown, their bases narrowly yellowish, the apices of the front four, immediate apex of the posterior femora, anterior four tibiae and tarsi yellow, the posterior tibiae yellow at the base, the apical

fourth brownish, the intermediate area becoming gradually darker to the apical brown region. Front femora with long white hair behind and below, the middle ones with shorter white hair behind on lower half; middle femora with anterior and posterior, the hind with anterior preapical bristle. Last two or three joints of the front four tarsi brownish, the anterior basitarsi not or scarcely swollen apically, three times as long as the next joint.

Wings tinged with brownish, darker anteriorly, the cross-vein almost rectangular. Squamae and halteres yellow, the former with white cilia.

Abdomen green on basal half and sides, the incisures and disc caudally, bronzed, conspicuously greyish pollinose. Hairs black; on the sides basally and on the venter, whitish. Genitalia brownish red, moderately greyish pollinose so as to somewhat obscure the actual colour and make it appear darker, the outer lamellae dirty yellowish, the inner brownish reddish, the hair shining yellowish. (Fig. 24)

Described from three males, Juliaetta, Idaho; May 2, 1902, collected by Dr. J. M. Aldrich.

Type—Male, Cat. No. 27079, U.S.N.M.

Paratype—♂, No. 670, in the Canadian National Collection, Ottawa.

19. *Rhaphium campestre* Curran

(Figs. 25, 26)

Length 6 mm. Face narrow, white, third antennal joint acute, nearly three times as long as wide, anterior femora black, the hind ones black on upper half except sometimes (in teneralis), the basal fifth.

Male. Face narrow, slightly widened above, silvery white. Front dark green, scarcely greyish pollinose, but narrowly brownish below. Orbital cilia black, reaching to about the middle of the eyes, the beard white. Occiput green, grey pollinose on lower half or more. Palpi black, covered with silvery pollen and clothed with whitish hair. Proboscis black. Antennae black, the third joint tapering to a point from just beyond the base, about two and one-half times as long as wide, the arista thickened on basal joint and not strongly differentiated. (See fig. 26)

Mesonotum and scutellum bright green, with a pair of brownish vittae on the anterior three-fourths which lie between the dorso-central and acrostical bristles. Lateral declivity behind the suture blackish; humeri greyish pollinose. Pleura green, with some blackish areas,

especially marked below the wing base, rather densely greyish pollinose. Prothorax white pilose. Scutellum evenly convex apically, with four bristles, the outer ones weak.

Coxae green and black, with greyish pollen, the pile greyish yellow, the middle coxae with a few strong apical bristles in addition to the black spine, the posterior coxae with a black bristle exteriorly but without apical spine; the anterior coxae without black bristles. Trochanters mostly blackish. Anterior femora green, with thin greyish dust, their apex and sometimes the narrow base reddish; posterior femora reddish on the lower half, (sometimes on the base above and apically) the upper half or less shining black or brownish black, the posterior tibiae brown except the dorsal surface on the basal two-thirds or less, their tarsi brown or black; middle and hind tarsi blackish from the apex of the first segment, the legs elsewhere reddish. Anterior tarsi short, the first joint twice as large apically as basally, the second also enlarged apically, not twice as long as the width of the first. Anterior femora with two preapical bristles in front, and four or five behind, two on the upper, the remainder on the lower margin, the middle femora with two in front and three behind, the posterior femora with one in front and two behind; anterior four femora with rather long whitish hair below, the legs elsewhere with black hairs and bristles.

Wings (Fig. 25) tinged with brown, the large cross-vein broadly whitish. Squamae and halteres yellow, the former with white cilia.

Abdomen green, the incisures blackish, the green portion conspicuously greyish white pollinose, the pollen more condensed laterally, the hairs black, the sides and venter with longer whitish hairs. Genitalia partly hidden, the outer lamellae yellowish with a brown upper margin and apex, elongate oval, the longer hairs black, the others pale. Inner lamellae brownish, becoming reddish on apical half, broad, elongate-triangular.

Female. Length 6.5 mm. Face wide, the upper section very slightly wider than long, the whole lower two-thirds of the head yellowish grey pollinose, the front except immediately above the antennae blackish bronze, the occiput apparently similar. Beard yellowish. Palpi large, triangular, black in ground colour, the tip reddish, the hairs black.

Mesonotum bronze-black, brown pollinose, the pollen leaving a narrow, almost bare stripe on the outer side of the acrosticals, which are small. The prescutellar depression green, with greyish pollen. Pleura green, with grey pollen.

Coxae green, their apices narrowly reddish, densely greyish pollinose

and clothed with greyish yellow hair, the middle ones with several black bristly hairs apically, the hind ones with a black bristle before the apex on the outer side. Legs reddish, the posterior femora slightly darker above apically, the narrow base of the posterior tibiae, the apical fifth on the posterior side, and the posterior tarsi wholly, black, the remaining tarsal joints as in the ♂. Femora with bristles as in ♂, but they are weaker, the pale pile much shorter. Anterior tarsi practically simple.

Wings as in ♂. Abdomen similar.

This species is characterized by the pale fascia about the cross-vein, which at once distinguishes it from any species described.

Originally described from Manitoba (type locality), Saskatchewan, Alberta and British Columbia. Additional specimens have come to hand from Alberta.

Type in the Canadian National Collection.

Paratypes—Male and female. Cat. No. 27524, U.S.N.M.

20. *Rhaphium subarmatum* Curran

(Fig. 27).

Length 6 to 6.5 mm. Allied to *slossonae* but the posterior tibiae are wholly black; face silvery white, beard white; third antennal joint three times as long as wide, acute.

Male. Face narrow, slightly widened above, silvery white. Front green, with more or less purplish reflection below, white pollinose. Occiput green, darker inside the black orbital bristles; whitish pollinose, the beard abundant, white. Palpi brown, with a white margin in some lights, their hair black. Antennae black, third joint about three times as long as wide, moderately tapering, its arista slightly longer than the joint, its first section not swollen, as broad as long.

Mesonotum brilliant green or greenish blue, very thinly pollinose, the declivous margins behind the suture darker. Pleura blackish, their middle green, greyish white pollinose. Propleura white pilose.

Coxae green, with greyish yellowish pollen and white pile, the anterior ones with two or three black bristles at apex towards the outer margin, the middle ones with a strong lateral one on the outer anterior edge and the outer half of the apex with strong, closely placed black hairs which do not form a thorn, the posterior coxae with a strong median exterior bristle. Trochanters black, the middle ones paler. Anterior femora and hind legs black, the apices of the front femora, middle legs and anterior tarsi reddish yellow, the middle tarsi black

from the apex of the first joint but the bases of the next two joints broadly paler, the anterior tarsi becoming brownish from the apex of the second joint. Anterior femora with long pale hair behind and below, the middle ones with shorter pale hair on these surfaces basally, with three anterior and posterior sub-ventral preapical bristles, the hind ones with conspicuous erect black hairs above and an incomplete row of short fine spinules below.

Wings tinged with brownish or luteous more so anteriorly, the cross-vein somewhat oblique. Squamae and halteres yellow, the former white ciliate.

Abdomen green, greyish pollinose, the broad incisures and last two segments purplish black. Hair black, on the sides basally and the venter, whitish. Genitalia black (fig. 27), the lamellae brown, with fairly coarse black hair.

Female. One specimen seems to belong here. Face narrow for a female, the upper section about twice as long as wide, silvery white. Palpi black, with brownish grey pollen, their pile black. Third antennal joint twice as long as wide, tapering, the arista two and a half times as long as the joint, its basal section thickened, not one and a half times as long as wide.

Anterior four femora and whole of hind legs, black, the middle tarsi as in the male, the front basitarsi with longer hairs than usual. Apex of middle femora, tibiae and base of tarsi reddish yellow. Middle femora with two anterior and two or three posterior preapical bristles and with rather long black hairs below, the hind ones with shorter hair than in the male and no distinct preapical bristle.

Type—♂, Oromocto, N.B., July 9, 1913, (A. B. Baird); No. 668 in the Canadian National Collection, Ottawa.

Allotype—♀, same data.

Paratypes—Male and female. Cat. No. 28080, U.S.N.M.; 2 ♂, Franconia, N.H.; 5 ♂, same data as type; ♀, Gornish, N.B., July 11, 1913.

21. *Rhaphium crassipes* Meigen

(Figs. 28, 29, 30, 31).

Length 4 to 4.5 mm. Front four legs yellow, the anterior femora largely and their last two tarsal joints black, the apical joint of these tarsi, the middle ones especially, broadened; hind legs black, the base of the tibiae and much of the femora yellow; posterior four coxae with

abundant longish, black bristly hair apically, but not with the normal spines.

Male. Face silvery white, in some views tinged with creamy yellowish, narrow, scarcely widened above. Front dark green, moderately greyish pollinose. Occiput green, with moderately abundant greyish pollen, the beard pale yellowish. Palpi normal, brownish with paler tips, their pollen greyish yellow, the few hairs whitish. Antennae black; third joint slightly longer than the front, gently concave below, rather strongly tapering, the arista one-fourth longer than the antenna. (See fig. 30)

Mesonotum dark green, moderately clothed with greyish brown pollen which leaves a sub-median darker stripe in certain views. Pleura thickly greyish pollinose. Propleural pile pale yellowish.

Coxae greenish black, grey pollinose, the front ones and base of the middle with yellowish tinged pile, the former without black hairs, the latter on the apex with abundant black hairs not forming a compact spine, the posterior coxae with similar abundant black bristles and on the outer side a row of bristly hairs, the basal half of which are yellow, the remainder black. Posterior legs black, the basal fifth of the femora and usually the whole under surface, and the basal fifth of the tibiae reddish yellow; anterior femora greenish black, the base narrowly, at least below, and the apical anterior lower half, or often the whole under edge, yellowish, the middle legs, anterior tibiae and the first three tarsal joints yellowish, the apical two tarsal joints black, the last joint of the anterior tarsi slightly broadened, that of the middle tarsi much so (fig. 29). Anterior basitarsi strongly angularly thickened at apex, the following joints not quite as long as the basal.

Wings quite cinereous in front, fading out to posterior edge; cross-vein slightly oblique. Squamae and halteres yellow, the former with white cilia.

Abdomen dark green, with a wide basal bronze triangle on each segment, the apical segment wholly bronze-black, the sides of the abdomen thickly greyish pollinose. Genitalia black, the long outer lamellae brownish or yellowish brown with brown margins, the hairs mostly brownish or partly brownish yellow. (See fig. 28)

Female Face moderately wide, brassy brownish grey pollinose, the upper section one and one-fourth as long as wide, the lower part one-fourth wider than long. Front almost concolorous with face. Palpi large, brown, with a reddish border, the hair black, the pollen similar to that on face. Third antennal joint one and one-fourth longer than

wide, triangular, the under edge gently concave; the arista slightly longer than the face.

Mesonotum more thickly pollinose. Coxae with shorter black hairs at apex, the hind ones without black bristles in the external row. Femora and tibiae reddish yellow except that the posterior surface of the front femora is usually chiefly brownish and the apical half to two-thirds of the hind ones is of the same colour on the upper half or at least on the apical third. Posterior basitarsi obscurely reddish at base, the front four tarsi with the apical two joints black. Only middle tibiae with strong posterior and anterior preapical bristles. The abdomen is lighter in colour.

Re-described from ten males and 30 females from Ottawa, Ont., and Megantic and Hull, Que., (Curran); and one female, Banff, Alta., August (Garrett).

This European species has been reported from Alaska by Van Duzee. I found it rather commonly at Megantic, Que., but have only taken it in the vicinity of suitable wooded areas as it seems to prefer shade to the open muddy banks of streams. Lundbeck reports it as occurring in "northern and middle Europe down into France; towards the north to Northern Sweden, and in Finland and Siberia."

The female is fairly easily recognized by its pollinose front and the colour of the legs.

22. *Rhaphium ornatum* Van Duzee

(Figs. 32, 33, 33a).

♂. Length 5 mm. Face narrow, silvery white. Front green. Antennae (fig. 32) black, third joint as long as the face; arista apical, as long as third joint. Beard moderately long, white; the black orbital cilia reach down nearly to the middle of the eye, there are three postvertical bristles on each side.

"Thorax shining green with a brown stripe on each side of the acrostichal bristles; scutellum with two pairs of marginal bristles, the outer ones much smaller than the inner pair; in one male there is a pair of marginal hairs between the central bristles.

"Abdomen green with bronze brown incisures and the usual white hairs on the sides. Hypopygium black with short, black, stiff hairs; its outer lamellae long, slender, tapering, blackish with yellow base, fringed with pale hairs; inner appendages slender, curved, yellowish, reaching the ventral edge of fourth segment. (See fig. 33a)

"Coxae black with white hair; middle pair with a long black thorn

at tip. Fore femora black more or less yellow on anterior surface, broadly yellow at tip, their lower posterior surface with long white hair, upper posterior surface with three small black bristles near the tip. Middle femora and basal half or more of hind femora yellow, the latter with nearly the apical half black; middle and hind femora each with a few small yellow hairs below. Fore and middle tibiae yellow, the former with a little silver pollen on posterior surface. Hind tibiae black with basal half of upper and about basal third of lower surface yellow. Fore tarsi (fig. 33) with the first two joints yellow, last four infuscated; the first is much widened below at tip; second joint two-thirds as wide as long, being nearly as wide as the tip of the first; joints of fore tarsi as 33-12-11-9-6. Middle tarsi black from the tip of first joint, their joints as 48-27-17-9-9, the first joint has several longer hairs at base below. Hind tarsi wholly black, their joints as 48-40-21-18-14. Calypters and their cilia yellow; knob of halteres yellow, stem brown.

"Wings slightly tinged with brown; third and fourth veins considerably bent, approaching each other and again separating just before their tips; last section of fifth vein one and one-half times as long as the cross-vein.

"♀. Face wide, rounded below, its suture at its middle; antennae small, third joint about as long as the two basal joints taken together; arista more than twice as long as the antennae. Femora and tibiae coloured about as in the male, except that the hind tibiae are yellow with about apical third black; femora with short hair; fore tarsi plain, blackened from the tip of the first joint. Wings about as in the male.

"Described from two males and two females; the males were taken at Colden, Erie County, New York, July 9 and 23; the females at Lancaster, Erie County, New York, June 2. Types in the collection of the author." (Original description)

R. petchi Curran is a synonym. Several specimens have been taken by the author at Hemmingford, Que., Hull, Que., and Ottawa, Ont. Up to the present only occasional specimens have been found, usually in rather open spaces along streams.

23. *Rhaphium rotundiceps* Loew

(Figs. 34, 35, 36).

Length 3.75 to 4.25 mm. Genital lamellae furcate; (fig. 34); anterior femora largely, the hind ones on apical third, apical fourth of their tibiae and hind tarsi black; middle coxae with long spine.

Male. Face very narrow, moderately widened on upper third;

silvery white. Front bright green, thinly whitish pollinose. Occiput blue-green, whitish pollinose, with long, not abundant white beard. Palpi small, brown, their tip silvery white, their pollen whitish when visible, the hairs black. Third antennal joint (fig. 35) almost as long as the face, rather broad, elongate triangular; arista almost as long as face and palpi.

Mesonotum rather bright green, moderately brownish grey pollinose, with a darker vitta on either side of the middle line. Pleura more or less blackish on posterior half, greyish pollinose. Propleural pile white.

Coxae blackish, greyish pollinose, nearly the apical half of the front ones yellow, the apex of the middle and hind ones more or less widely reddish. Anterior coxae, base of middle, and outer surface of hind ones with not abundant whitish hair, the front ones with three to five bristly black hairs apically, the middle ones with stout black hairs on outer edge and apical half and a long, strong black spine; the hind ones with only two or three inconspicuous black hairs at apex. Trochanters and legs yellowish, the anterior femora chiefly brownish, with the apical third (more or less, more below) yellowish, the apical third of the hind femora, apical fourth of their tibiae and all of their tarsi, black, the apices of the first two joints of the front four tarsi and the whole of the following three joints, brown. Anterior basitarsi simple. (See fig. 36.) Anterior femora with one or two preapical posterior bristles, the middle and hind each with one anterior, the middle with two posterior.

Wings moderately tinged with brownish, the cross-vein slightly oblique. Squamae and halteres yellow, the former with fine white cilia.

Abdomen brassy green, rather thickly greyish pollinose, the narrow base and elongate median triangle bronzed, the terminal segment largely brilliant bluish. Genitalia black, the inner and outer lamellae (fig. 34) brown, with fine brownish yellow hairs.

Female. Face one-fourth head width, greyish argenteous, the upper section but little longer than wide, the lower as long as the upper. Front blue green, thinly whitish pollinose. Palpi rather large, sub-triangular, fairly acute, pollinose like the face, their hair black, tip obscurely reddish, ground colour brownish. Third antennal joint sub-cordate, as wide as long; arista as long as face and palpi, slender.

Anterior coxae with only the bases brownish; the hair as in the male but shorter and less abundant; lacking the preapical bristle on outer side of hind ones. Legs as in male but the anterior femora are usually all yellow and only the apical fifth of the hind ones are black except below, where it is obscurely reddish and always less widely black.

Abdomen rather brassy green in mature specimens. In a teneral female the face is argenteous.

Description from numerous specimens from Hull, Quebec, June, July. Originally described from District of Columbia. Occurs in New England States and probably all north-eastern America.

The female of this species is extremely difficult to distinguish from its allies, and only the fact that two pairs were obtained in coitu enables me definitely to associate specimens with the male, which has very distinct genitalia.

24. *Rhaphium grande* Curran

(Figs. 37, 48)

Large, 7.5 mm. Thorax bright green or blue green; middle and hind coxae with terminal thorn of black hairs; cilia of squamae and halteres yellow; legs chiefly yellowish.

Length 7.5 mm. *Male*. Face very narrow; narrowest about the lower two-thirds; shining yellowish white; brown just below each antenna. Front bright green, the sides and ocellar tubercle deep blue or blackish; bare except for the black bristles. Occiput green; superior bristles black; hairs on lower half white, abundant. Antennae (fig. 38) black; third joint elongate oval-triangular, its apex sharply rounded; arista terminal, its first joint twice as long as wide, rather stout. Eyes brown pilose, the posterior orbits with pale pile. Palpi black, yellow pollinose anteriorly, black haired.

Thorax brassy green, sometimes bluish on the disk, with a wide, geminate, slightly darker median line; scarcely pollinose; pleura thinly greyish white pollinose. Bristles black; propleura with rather abundant milky white hair. Scutellum concolorous with disk of thorax, with three or four bristles laterally, the inner one much the strongest.

Legs: coxae blackish, rather thickly greyish pollinose; all rather abundantly milky white pilose; the front four with a long, black, stout hair on the outer surface sub-apically, the middle ones with a long apical thorn of dark hairs, the hind ones with a much shorter apical thorn and no external bristle. Front femora metallic green, the narrow base and broader apex, reddish yellow; middle and hind femora reddish yellow, the former with a metallic green stripe on the inferior basal half, the latter with a ventral black stripe. Femora black-haired, the front four white-haired beneath, the middle ones with long hair beneath; front femora with rather long moderately abundant black hair on posterior surface, stouter apically; the middle and hind each with five to eight

strong black bristles behind and three or four in front apically. Hind femora black above at apex. Tibiae yellowish, the hind ones black on inner surface, their apex darkened, all with two rows of black bristles outwardly, the middle ones with two bristles on apical fourth beneath, one anterior, one posterior. Tarsi black, the front four basitarsi wholly pale, the front one swollen at apex, the second joint rising at its top.

Wings hyaline, yellowish anteriorly and along the veins; anal cell rounded apically. Third vein curved backward apically, the fourth vein curved forward beyond the middle of its last section, then curved back apically to end in the tip of the wing. Costa simple. Alulae small with long fringe of white hairs. Squamae pallidly yellowish, with long yellowish white cilia. Halteres yellow, their basal half pale brownish, finely whitish pubescent.

Abdomen metallic green, with brassy reflections; first segment and narrow bases of the remainder, broadened medianly, blackish, rather dull, bordered with bronze. Hairs sparse, black; first three segments with long pale yellow hairs laterally. Sixth segment bright blue. (What I have termed the first segment in describing the colour is not usually counted and I have not counted it otherwise.) Genitalia (fig. 37) black, the bulb more or less greenish. Lamellae moderately broad sub-basally, as long as last two abdominal segments, dirty yellowish, the apical fourth brown, hair black. Claspers black, shining, flattened, with subparallel sides, the end a little curved downwards so as to appear clubbed from lateral view; from same view they are very thin. Sides of abdomen thinly white pollinose.

Originally described from British Columbia and not since recorded. Type in Canadian National Collection.

25. *Rhaphium slossonae* Johnson

(Fig. 39).

Large, bluish species, with bronzy black abdominal incisures and violaceous terminal segment. Middle and hind coxae with spine.

Length 6.5 to 7.25 mm. *Male*. Face extremely narrow, slightly widened below, rather strongly widened above, silvery yellowish white. Front brilliant green, with thin whitish pollen. Occiput bright green, with more or less extensive blue areas, the pollen greyish white; beard white. Palpi black, whitish pollinose, the hairs black. Third antennal joint twice as long as wide, rather wide apically, the under edge gently concave. Arista apical, slightly longer than the face.

Mesonotum brilliant green or blue green, often with blue or

violaceous reflections, the latter more or less in the form of vittae, the usual darker vittae bronzed, the whole very thinly brownish pollinose. Pleura with more or less blackish areas, thickly greyish pollinose. Propleural pile white.

Coxae black, with more or less greenish reflections; thickly greyish pollinose, their apices broadly reddish; pile greyish white; several black bristles towards apex of front coxae on outer edge; apical third of middle ones with stout black hairs which form a long spine, the hind ones with a slender spine, the irregular pile on outer edge pale. Femora reddish yellow, the anterior femora broadly black on the dorso-posterior surface except at base and apex or this colour may extend on to most of the upper surface; apical fourth of posterior femora and their tibiae and tarsi, black, the anterior four tarsi brownish from tip of first joint or with the base of the second joint reddish. Anterior basitarsi enlarged on apex to more than double their basal width, the anterior edge of all the joints with longer hair than elsewhere. Anterior femora with two or three anterior and four to six posterior preapical bristles, the middle ones with three anterior and four or five posterior, the hind femora with one on each surface. Anterior four femora with long white pile behind and beneath.

Wings cinereous hyaline, with a slight brownish tinge. Cross-vein slightly oblique. Squamae and halteres yellow, the former with abundant long whitish cilia.

Abdomen bright green, the bases of the segments broadly bronzed black, increasingly widely so, the last segment violaceous or brilliant bluish. Pale areas with abundant greyish white pollen, especially laterally. Hairs black; long and whitish on sides and venter. Genitalia (fig. 39) dark green on basal portion, elsewhere rather dull black, the long lamellae brownish, with long, fine, brownish, hairs, the inner black ones with shorter fine brown hairs.

Female. Face argenteous, the upper section one and one-third as long as wide, the lower section wider than long. Palpi black, with greyish pollen on base, outer margin and apex, elsewhere the pollen brownish, the hairs black. Third antennal joint small, one and one-third times as long as wide, very conspicuously concave on under surface beyond middle; arista longer than face.

Middle coxae with only a few black hairs; anterior femora normally all reddish yellow, the hind ones darkened on apical sixth except below, the bristles on the femora as in male; only slightly variable. Tarsi simple. Abdomen with the terminal segments bronzed.

Descriptions from 12 ♂ and 5 ♀ from Hull, Que. Specimens have

been examined from Montreal, Que.; Fredericton, N.B., and New York State. Originally described from New Hampshire.

I have taken this species only along the shores of the Ottawa River, and Brother Joseph Ouellet took it along the St. Lawrence River at Montreal. It seems to prefer the borders of rivers as it was not found elsewhere.

There is a number of allied species of very similar appearance, *R. grandis* Curran being the closest related form, but it is readily distinguished by having the under surface of the hind femora wholly black.

26. *Rhaphium elegantulum* Meigen

(Fig. 40)

Male. Vertex and frons aeneous; eyes whitish-hairy. Epistoma very narrow, silvery white. Palpi small, greyish. Occiput green, a little greyish pruinose; postocular hairs black above, white below. Antennae black, not long, shorter than the head, the third joint longer than the two basal; arista longer than the antennae. Thorax bright green, not pruinose, shining. Pleura green, greyish pruinose; propleural hairs pale. Abdomen green or more or less coppery, especially towards the end, the sixth segment steel-blue or somewhat purplish; abdomen haired with short, black hairs, longer and pale at the sides of the three first segments; there are short hindmarginal bristles, longer on the first segment. Venter grey, with white hairs, which are long towards the base. Hypopygium (fig. 40) black or blackish green; the ventral lobes somewhat long, blackish brown, a little dilated and hollowed and thus somewhat spoon-like; outer lamellae rather long, simple, they are narrow, attenuated into a long apex, of dirty yellowish or brownish colour, longish-haired. Legs with the coxae grey, femora yellow, hind femora black at the apex, especially above; tibiae yellow, hind tibiae black towards the apex; anterior tarsi blackish or brown about from the apex of metatarsus, hind tarsi black. Middle coxae with a strong, hind coxae with a small, black apical spine; front metatarsus as long as the two next joints, thickened below towards the apex; middle metatarsus shorter than the following joint. The legs have short, black hairs, the coxae are whitish-haired, front coxae with a few black bristles at apex; front femora with short, middle femora with somewhat long, white hairs below, otherwise the femora only short-haired; they have all some bristles at the apex on both sides; all tibiae with long bristles in two dorsal rows, the middle tibiae besides with a ventral pair of bristles

below the middle; middle metatarsi a little spinulose beneath. Wings somewhat brownish; veins black, discal vein with a slight and even curve. Squamulae yellow, with a whitish yellow fringe. Halteres yellow.

"Female. Similar to the male. Epistoma broad, this and the large palpi brownish grey. Antennae shorter than in the male, third joint about as long as first two, arista somewhat longer than the antennae. Legs about as in the male, hind femora not or slightly dark at the apex; anterior metatarsi relatively longer, about of the length of the three next joints, there are no coxal spines and the front metatarsi are simple. Front and middle coxae with some black, bristly hairs at the apex. Femora quite short-haired. Wings more brownish than in the male.

"Length 5.8 to 7 mm.

"The pupa is yellow, it has a length of about 8 mm. (exuvia)." (Lundbeck)

Van Duzee reports this species from Alaska. Otherwise it has not been recorded from North America. It is widely distributed in Europe. Type probably in Paris Museum.

27. *Rhaphium tricaudatum* Van Duzee

Ohio Jour. Sci., XXIII, 243, 1923.

"Male. Length 4 mm.; of wing the same. Face very narrow, silvery white. Palpi black. Front green. Antennae black; third joint about twice as long as the two basal joints taken together. Arista about as long as the antenna. Orbital cilia black, descending to upper third of the eye. Beard abundant, whitish; eyes with white hair.

"Thorax and abdomen green, a little dulled with grayish pollen, the former with the usual two dark lines in front. Hypopygium black with its outer lamellae divided into three long branches, the posterior one the shortest; they are brownish, fringed with long pale hairs; inner appendages black, straight, styliform.

"Coxae and femora black; fore and middle femora yellow at tip. Fore coxae with long white hair on its anterior surface, without black ones at tip. Middle and hind coxae with less abundant white hair, without a spine at tip. Fore femora with rather long pale hair on posterior surface, those near the tip black and bristle-like. Middle femora with long white hairs below on basal half and several black bristles on each side at tip. Hind femora with one or two preapical bristles. Tibiae yellow; fore and middle ones each with two rows of long bristles; posterior pair a little blackened at tip, its bristles rather strong, but

shorter than on the other tibiae. Fore tarsi longer than their tibiae, the first two joints and base of third yellow, last three joints black; first joint thickened at tip, as long as second, second a little excavated below near the base and slightly so before the tip; first and basal half of second joint with a row of minute blunt spines below; third and fifth joints of nearly equal length, fourth a little shorter; middle tarsi yellow with last two joints black, of nearly equal length, slightly compressed, so that the fifth is twice as wide as the third. Hind tarsi brown, only the last two joints black, first scarcely longer than the second and about equal to the third and fourth taken together; fifth joint but little longer than wide. Calypters, their cilia and the halteres yellow.

"Wings greyish; third vein gently and evenly arched; last section of fourth vein a little bent just beyond its middle, nearly parallel with third towards its tip, ending in the apex of the wing; last section of fifth vein scarcely twice as long as the cross-vein; hind margin of wing nearly evenly rounded.

"Female. Face wide, grey, the ground colour sometimes showing through on the lower part, which is somewhat rounded in outline below; suture just below the middle of the face. Antennae black, small, third joint about as long as wide, scarcely pointed at tip, arista nearly three times as long as the antenna. Front opaque with gray pollen. Beard yellowish white. Palpi large, obtusely pointed, black with black hair and white pollen. Fore coxae more or less yellowish with rather long white hair; I see two black hairs at tip in some specimens. Femora and tibiae yellow; posterior femora and tibiae blackened at tips. Fore femora with a row of rather long black hairs on upper posterior edge, ending in several slender bristles. Middle and hind femora each with one or more preapical bristles. Fore and middle tarsi darkened from the tip of first joint, still only the apical joints black, both with their joints normal, the first joint being nearly as long as the following three joints taken together. Hind tarsi about as in the male. Wings as in the male, except that the last section of fifth vein is fully twice as long as the cross-vein.

"Described from one male and seven females, taken at Savonoski, Nakinek Lake, Alaska, in June and July, 1919, and two females from Katmai, Alaska, in August, 1917.

"This is very much like *tridactyla* Frey, from Lapland. The male differs in having the inner appendages of the hypopygium nearly straight and not enlarged at tip; and in having the hind tibiae largely yellow.

"The outer lamellae are also very slightly different from his drawing of those of *tridactyla*. The female differs in having the tips of the hind

femora broadly black on upper and lateral surfaces. The front nearly opaque with white pollen, and the last two joints of middle tarsi not widened." (Original description)

28. *Rhaphium canadense* Curran

(Figs. 41, 42).

Length 4 to 4.5 mm. Allied to *tridactyla* Frey of Europe and *tricaudatum* V.D. from Alaska. Genital lamellae with three branches; middle femora wholly yellow.

Male. Face narrow, silvery white, slightly widened above; palpi small, silvery white, with whitish hairs. Front bluish, sometimes with a brassy reflection, which makes it appear more greenish, the whole margin narrowly blackish; thinly yellowish pollinose, the pollen more evident below. Occiput green, mostly covered with white pollen, the cilia black to slightly below the level of the antennae, the pile elsewhere long, not very dense, white. Antennae black, the first two joints polished; second joint four times as wide as long, the third about three times as long as wide, tapering from base to the rather acute apex, the antennae about as long as the face; arista not quite apical, although appearing so, as long as the third joint, its basal segment slightly longer than wide. (See fig. 42)

Mesonotum green, thinly greyish pollinose; a median geminate vitta and a sub-lateral stripe bronzed; pleura green, white pollinose.

Coxae green, white pollinose and pilose, the middle ones with a strong black apical thorn, the hind ones with a pencil composed of three or four hairs. Legs yellowish; front femora blackened posteriorly and above except at base and apex; posterior femora on apical third, (only apical fourth below), the posterior tarsi and last two joints of the front and middle tarsi, black, the posterior tibiae brownish yellow, appearing blackish from most views. Long pile on middle and front femora white. The rest of the hair black. Middle femora with one anterior and one posterior preapical bristle, the hind ones with one anterior. Posterior legs no longer than usual; front basitarsus incrassated apically.

Wings cinereous hyaline, quite greyish when seen together; posterior cross vein slightly oblique and very gently curved. Squamae yellow, with white cilia.

Abdomen bronze green, the sides green and moderately white pollinose, the narrow incisures and last segment blackish. Pile white along the sides, elsewhere black. Each segment with an apical row of black bristles. Outer lamellae brownish yellow, the three nearly equal

arms black, each arm fringed with not abundant long, straight or curved stout hairs, the outer or first branch with a dense terminal tuft of short, yellow, apically curved hairs, the inner or apical branch with a smaller tuft of finer white hairs, the middle arm not with apical condensation of short hairs. Inner lamellae long, slender, yellow, broadened at the sub-apical third to form a small, whitish fringed lobe, their apical third slender, acute. (See fig. 41)

Female. Face silvery, one-fifth the width of the head; apical third of palpi yellow, base black; covered with yellow pollen, all the hairs black, one hair near the apex distinctly stronger than the others; front nearly one-fourth the width of the head, bright blue, on the lower half rather thickly white pollinose, above, thinly so.

Legs yellow, the last two joints of the front four and the whole of the posterior tarsi, blackish.

This species differs from *P. tridactyla* Frey of Europe in having the middle tarsi plain. In *tridactyla* the arms of the genital lamella are not equal in length, the inner being less than a third as long as the terminal and the inner lamellae are short and broad. (Curran)

Originally described from the Province of Quebec. Specimens have been examined from New York and Ohio.

Type in Canadian National Collection.

Paratypes—Male and female. Cat. No. 26501, U.S.N.M.

29. *Rhaphium punctitarsis* Curran (Figs. 43, 44).

Length, 5 mm; antennae slightly over 1 mm. A peculiar species having lamellae, which are formed of triangles borne on a short stem, their anterior edge transverse but still somewhat concave and dentate, their inner edge straight, the outer-posterior edge gently convex, and with the apical half of the third joint of the middle tarsus pure white, the tarsus yellow basally, black beyond.

Male. Face rather narrow, its sides almost parallel, perhaps slightly convex about the middle, silvery white. Front blue, at least bluish in the middle above, polished; black immediately above the antennae. Occiput green, whitish pollinose except above; cilia black to the level of antennae, the hair white. Antennae black, first joint thick, not long; third joint not quite as long as the height of the head, tapering from base to apex, wider than the second joint at the base, without noticeable

pubescence; arista about one-third as long as third joint. Palpi yellow, white pollinose apically, their hair white, proboscis brown.

Mesonotum green, thinly pollinose, the pollen appearing to form greyish yellow vittae in some lights. A polished bronze area before the root of the wing; sides before the suture white pollinose. Pleura blue-green or partly blackish, moderately white pollinose.

Coxae green, whitish pollinose, white pilose, the middle ones with an apical thorn of black hair, the posterior ones with a weak pencil of only four or five hairs. Legs reddish yellow; posterior femora with a black streak on basal half below, above either wholly black or pale on the middle part, the apical sixth, extending basally above, black; posterior tibiae and tarsi and last two joints of remaining tarsi, black. Apical half of third joint of middle tarsi white. Long pile behind the front femora and shorter pile basally beneath the remainder, white, the pile elsewhere black, the white part of the tarsi bare. Front basitarsus more swollen than usual apically; third joint of middle tarsi as long as the two following but scarcely as long as the second; first joint of hind tarsi slightly shorter than the second. (See fig. 44). Preapical femoral bristles farther from apex than usual, the middle femora with two, the posterior one at apical sixth, the hind femora with one small one.

Wings cinereous, somewhat narrower basally than is usual. Squamae yellow, with white cilia. Halteres yellow.

Abdomen green, whitish pollinose laterally, brassy on dorsum, the bases of the segments bronzed, darker at immediate base; sixth segment black. Pile black, white laterally. Genitalia short, roundish, black, the lamellae as described above, their stem brownish yellow, the broad apex polished black, the teeth and outer margin with moderately long, fine yellow hairs.

Female. Face wider, silvery white; palpi yellow, becoming black on basal third, their pile black. Front bright blue; dull brown below the transverse carina. Third antennal joint three times as long as wide, two-thirds as long as the face, elongate triangular, its lower edge slightly concave sub-basally; arista slightly longer than the face.

Front coxae very narrowly pale apically; middle coxae margined with strong black hairs apically, their apex narrowly pale. Posterior femora at most slightly brown at base below and above, their apical sixth black. Posterior tibiae and tarsi and apical two and a half joints of the front four tarsi, black, though sometimes only the last two joints are black, the second joint often brownish.

Originally described from 9 specimens from Hull, Quebec, collected during June, 1923. In 1924 this species was extremely abundant in a

swamp at Aylmer, Quebec, and well over a hundred specimens were taken in two days. In addition, the species occurred fairly commonly at Hull during the same year. The dates range from April to July, but the species was most abundant during April and May. It is found, insofar as my experience goes, only in shady swamps where specimens are fond of resting on leaves in small sunny patches.

Type in Canadian National Collection.

Paratypes—Females, Cat. No. 26502. U.S.N.M. The National Museum also contains specimens of both sexes from Aylmer, Que.

30. *Rhaphium gracile* Curran
(Figs. 45, 46, 47).

Length, 5.5 mm. Face and beard white; front bright green; legs chiefly yellow, the posterior tibiae and tarsi brown; outer lamellae triangular, broad, jagged apically, the inner ones very slender, long; middle coxae with a black apical spine; arista shorter than the long riband-like third antennal joint.

Male. Face narrow, white, its sides almost parallel; front brilliant green-blue. Occiput green, greyish pollinose except above; orbital cilia black, not descending to the middle of the eyes, the beard abundant, white. Proboscis brown; palpi small, yellow, with white pollen and hairs. Antennae (fig. 46) black; third joint slightly tapering, not quite as long as the height of the head, the arista slightly over one half as long as the third joint, fairly stout, the penultimate section not twice as long as wide.

Mesonotum and scutellum blue-green, with scarcely a trace of pale pollen, the pleura green, more or less blackish below, moderately covered with greyish pollen. Propleura white pilose.

Coxae brownish, the apices of the front four moderately broadly yellow, the whole greyish pollinose, the hair white, the middle ones with a black apical spine, the posterior ones without a black bristle on outer side. Legs yellow, the apex of the posterior femora, at least above, the last two or three joints of the anterior four tarsi and the posterior trochanters, brown or blackish. Anterior femora behind and the anterior four on the basal half below with fairly long pale hair, the middle ones with an anterior and posterior, the hind ones with an anterior preapical bristle. Anterior basitarsus swollen apically, the following joint not quite half as long, slightly swollen, the whole tarsus with conspicuous erect black hairs above.

Wings tinged with yellowish brown, the cross-vein almost transverse. Squamae and halteres yellow, the former white ciliate.

Abdomen green, the incisures bronzed, the last segment dark greenish blue; sides of the abdomen and disc basally greyish white pollinose. Hairs black; whitish on sides and venter. Genitalia black (fig. 45), the outer lamellae dirty yellowish becoming brown, the inner shining reddish; the outer with very fine rather brownish yellow hairs.

Female. Face moderately narrow, argenteous, the upper portion one and one-fourth as long as wide; front violaceous. Beard sparse; palpi reddish, with greyish pollen, short black hair, and one longer sub-apical bristle. Third antennal joint elongate triangular, slightly over twice as long as wide; arista slightly longer than the face. (See fig. 47)

Middle coxae with several black hairs on the outer side apically and with a row of stout yellow apical hairs which appear blackish in some lights. Pile as in male but shorter; legs similarly colored but the anterior four tarsi paler, the last joint inclined to be reddish. Wings paler.

Described from four specimens collected by Burgess at Beverley, Mass., May 23, 1870, from C. V. Riley Collection.

Type and Allotype—Male and female, Cat. No. 28081, U.S.N.M.

Paratype—Male, No. 647 in the Canadian National Collection, Ottawa.

31. *Rhaphium longipes* Loew

Male. Green; face white; coxae black-green; the four anterior feet yellow, the last joints of the tarsi black; the basis of the femora and the upper side of the tibiae, with the exception of the tip, brownish-yellow, the tip of the tibiae and the tarsi brown; the exterior appendages of the hypopygium linear, bipartite.

Long. corp. 0.26. Long. al. 0.21.

Dark green, shining; thorax with two narrow approximated dark streaks. Front covered with white dust. Antennae black; the third joint lanceolate; the arista a little shorter than the antennae. The narrow face white. The lower part of the occiput clothed with dense yellowish hair. Abdomen above with black, on the sides with yellowish-white hairs. The exterior appendages of the hypopygium dusky yellowish, linear, bipartite, and beset with delicate whitish hairs. Fore feet yellow; the last two joints of the tarsi black; the tip of the preceding joint black-brown; the fore femora upon the latter part of the upper side, blackened; the tip of the first joint of the fore tarsi incrassated, almost dentiform on the under side. Hind femora black with brownish-yellow basis. Hind tibiae and hind tarsi comparatively stout; the tibiae black, on the upper side, with the exception of the tip, brownish-yellow or

yellow, the tip brown; the tarsi brown, their tips black. All the feet longer than in most of the other species of *Porphyrops*. All the coxae greenish-black with a pale pubescence; the middle ones, at their tips, with black, approximated bristles, forming a tuft, not unlike a thorn. Tegulae yellowish, with whitish cilia. Wings tinged with brownish-grey and with blackish-brown veins; the end of the third longitudinal vein gently curved downwards; the last segment of the fourth longitudinal vein inflected.

Hab. White Mountains, New Hampshire. (Osten-Sacken). (Translation of original description).

There is a single ♀ from Barber Dam, N.B., June 25, (F. M. McKenzie) in the Canadian National Collection, which is evidently this species. The third antennal joint is almost three times as long as wide, the arista scarcely longer than the antennae and the posterior femora black on almost the apical third.

Type in Mus. Comp. Zool., Cambridge, Mass.

32. *Rhaphium signifer* O.S.

(Figs. 48, 49).

Length, 4.5 to 5 mm. Arista tipped with a small lamella; legs chiefly yellow, the hind tibiae and tarsi black; middle coxae with rather short, robust spine.

Male. Face narrow, somewhat widened above, silvery white. Front blue green, thickly silvery white pollinose. Occiput bronzed green, silvery greyish pollinose, the moderately thick beard white. Palpi small, black, silvery pollinose. Third antennal joint about as long as the face, fairly wide, tapering, the arista situated slightly above the tip, about as long as the joint and ending in a small rectangularly oval lamella. (See fig. 49)

Mesonotum rather bright, dark green, with four purplish bronzed vittae, the thin pollen greyish. Pleura partly blackish; moderately greyish pollinose. Propleural pile white.

Coxae often chiefly reddish yellow, the front ones more or less brown basally, the posterior four brown on the outer surface and outer anterior border for more than half their length in most cases; all white pilose; middle coxae with a stout, rather short, loosely assembled spine of black hairs, the hind ones with a few short, fine hairs on the outer side and one long, fine yellow bristle beyond the middle. Legs yellow, the hind femora rather brownish above on the apical half and narrowly at the apex except below, their tibiae and tarsi wholly black; last three joints of the anterior four tarsi brown, the apices of the two preceding joints

similar. Anterior basitarsi thickened on apical fourth. Considerable long white pile on anterior four femora.

Wings rather strongly cinereous, the cross-vein oblique. Squamae and halteres yellow, the former with fine white cilia.

Abdomen rather bright green on the sides, the disc chiefly bronzed as there is a large basal triangle of this colour on each segment and the last segment is wholly so, the thin greyish pollen limited to the lighter areas. Hair black, on the sides and venter yellowish tinged. Genitalia (fig. 48) black, the small outer lamellae brown and with brown hair. Inner lamellae with yellow apex.

Female. Face moderately wide, both the upper and lower sections longer than wide, palpi moderately large, with silvery margin, argenteous yellow pollen and black hairs. Third antennal joint cordate oval, the arista distinctly above the tip, not quite as long as face and palpi, usually slightly widened before its tip.

Legs coloured as in male, but posterior femora only a little blackened. Anterior coxae with one or two black bristles towards the apex on the outer side; middle coxae chiefly stout black haired. Anterior basitarsi simple. Middle femora with one anterior and posterior preapical bristle, the others devoid of them.

Described from 25 males and 10 females, Orillia, Ont., July.

The male is very readily recognized by the lamellate arista and the female, when the tip of the arista is thickened, offers no difficulty.

I found this species to be rather common in swampy areas where there was a moderate amount of low herbage. It seems to prefer woods to the open places frequented by most of the species.

Type in Museum of Comparative Zoology, Cambridge, Mass.

Specimens of both sexes are deposited in the United States National Museum.

33. *Rhaphium effilatum* Wheeler (Figs. 50, 51).

Length, 4 to 4.5 mm. Coxae without spines; genital lamella not branched, elongate; face and beard white; anterior femora chiefly, the hind ones on about the apical half, and their tibiae except on the basal third dorsally, black.

Male. Face narrow, slightly widened above, silvery white. Front metallic green, more or less bronzed, moderately covered with greyish pollen. Occiput blue-green, more or less bronzed above, the pollen greyish; beard white. Palpi brown with reddish apices, the pollen appearing silvery from some views, the pile silvery white, long, fairly

abundant, directed downwards. Third antennal joint hardly as long as the front, elongate triangular, the terminal slender arista as long as the face. (See fig. 51)

Mesonotum rather blue green, with more or less brassy or bronze reflections, rather thickly greyish brown pollinose, the usual two bronze-brownish vittae distinct. Pleura, thickly whitish grey pollinose. Propleural pile white.

Coxae black, with green reflections, rather thickly grey pollinose, the apical third or fourth of the front and broad apices of the middle coxae reddish yellow; pile white, abundant, rather long on the front pair, not arranged in a single row on the outer surface of the hind ones. Anterior trochanters, base and apex of the front femora, basal half of the hind ones, the anterior tibiae, middle legs and front four basitarsi, yellow; posterior trochanters, apical half, (more or less) of the hind femora, their tibiae and tarsi, black, the hind tibiae rather yellowish white on the basal third of the dorsal surface. Anterior basitarsi simple, but with a row of tiny bristles on antero-ventral surface, the middle basitarsi with three small, increasingly shorter bristles on basal half of under surface. Anterior and middle femora with white pile behind, the former with one posterior, the latter with anterior and posterior preapical bristle, the hind femora with a strong anterior one. Anterior four tarsi brownish from tip of first joint.

Wings tinged with cinereous, the cross-vein oblique. Squamae and halteres yellow, the former with white cilia.

Abdomen grey green, the incisures bronzed, the apical segment chiefly of this colour, or the bronzed markings even more extensive, the paler portions greyish pollinose. Hairs black, the lateral and ventral pile yellowish white. Genitalia black (fig. 50), the lamellae brownish, with delicate brownish hairs, the inner lamellae black, with a few short black, bristly hairs on outer surface.

Female. Face of moderate width, argenteous, both upper and lower portions very slightly longer than wide or rarely almost equal, front bright bronze in most lights, thinly greyish pollinose. Palpi large, blackish, their tip reddish, pollen yellowish grey, hairs black. Third antennal joint one and one fourth as long as wide, obliquely sub-cordate; arista longer than the face.

Mesonotum usually more bronzed. Coxae as in male. Legs reddish yellow or reddish, the anterior femora usually greenish except base and apex, but sometimes the upper and lower edges and rarely nearly the whole front surface is reddish or but little darkened, the posterior femora with the apical third and their tarsi wholly, black; anterior tarsi as in male, the base of the second joint more or less reddish. Bristles on

femora as in male. Abdomen usually chiefly bronzed, with paler base and sides.

Re-described from more than a hundred specimens from Nova Scotia, New York, Quebec, Ontario, Manitoba, Alberta and British Columbia.

This is the most widely distributed and commonest species found in North America. It ranges well north in Canada and at least covers the northern half of the United States and extends into Colorado. It is not at all rare in Kansas.

R. effilatum may be found almost everywhere where there are muddy patches along streams or ponds and even on small muddy areas in swamps. It is one of the earliest species in spring, and there is apparently a second generation in August, as it is again common during that month, although not much in evidence in July.

Type in American Museum of Natural History, New York.

34. *Rhaphium nigricoxa* Loew
(Fig. 63).

Female. Metallic-green, front, thorax and scutellum very coppery. Face with yellowish-grey dust; the separation between its upper and lower part is particularly striking. Palpi comparatively small, black with yellowish-grey dust; antennae black; third joint ovate; arista 1-1/2 the length of the antennae. Front with thin yellowish-grey dust. Cilia on the upper orbit black, on the lateral and inferior orbits white. All the coxae entirely black, with grey dust and whitish hair; at the end of the fore and middle coxae there are no black bristles. Feet yellow, apical half of the hind femora black, the last third of the hind tibiae and the hind tarsi altogether are of the same colour; middle and fore tarsi strongly infuscated from the root and towards the end black. Cilia of the yellowish tegulae white. Halteres pale-yellowish. Wings grey, on the fore margin more brownish grey; the last segment of the fourth longitudinal vein, beyond the middle, gently inflected forward.

Hab. Maryland. (Loew).

There is a single specimen in the Canadian National Collection donated by Dr. J. M. Aldrich. This was captured at Washington, D.C., in July, 1920. There are additional specimens in the United States National Museum, but up to the present the ♂ has not been recognized. *R. insolitum* n. sp. may eventually prove to be the ♂ of *nigricoxa*, but there is no evidence to prove this and it seems advisable to consider the two distinct for the present.

Type in Mus. Comp. Zool., Cambridge, Mass.

35. *Rhaphium robustum* new species
(Figs. 52, 53).

Length, 5 mm. Face white; third antennal joint not twice as long as wide; beard yellow; anterior four tarsi yellow, the last two joints flattened, black, the legs mostly reddish.

Male. Face narrow, slightly widened above, silvery white; front green, the middle bronzed. Occiput bright green, not pollinose; orbital cilia black, strong; beard yellow. Palpi black, with silvery pollen and white hairs. Antennae black, the third joint sub-triangular, not over one and one-half times as long as wide; arista three-fourths as long as the face, the penultimate joint swollen, not over one and one-half times as long as wide. (See fig. 53)

Mesonotum and scutellum bright green, thinly greyish pollinose, a vitta between the acrostical and dorsocentral bristles bare. Pleura green and blackish, with grey pollen. Propleura with yellowish pile.

Coxae greenish, grey pollinose, yellowish pilose, the anterior four with a row of apical, short black bristles, the hind ones with a bristle beyond the middle on the outer side. Trochanters black or brown. Anterior femora black, the apical fifth reddish; pile long, yellowish on posterior and lower surfaces; several long black hairs behind apically and a few in front. Middle femora reddish, the under side green on at least the basal half of the ventral surface, where the pile is rather long, white; with two anterior and two or three posterior ventral bristles. Posterior femora reddish, the apical fourth or less black; with one anterior and one posterior preapical bristle. Tibiae reddish, the posterior ones broadly black apically, their bases scarcely darkened. Tarsi black, the first three joints of the front four yellow, the last two joints of the front four tarsi flattened, the last joint with parallel sides; anterior basitarsi scarcely swollen apically, four times as long as the second joint, the last joint not quite as long as the two preceding, but as long as the second. Middle basitarsi with several isolated short black bristles below.

Wings slightly tinged with brownish; cross-vein slightly oblique. Squamae and halteres yellow, the former yellowish ciliate.

Abdomen green, grey pollinose, in some views chiefly bronzed, the incisures darker. Hair black; on the sides and venter pale yellowish. Genitalia black, shaped as in fig. 52, fringed with short brownish hair.

Described from two males, collected by Dr. J. M. Aldrich in Idaho.

Type—Male, Cat. No. 28082, U.S.N.M., from Lewiston, Idaho.

Paratype—Male, Juliaetta, Ida.; No. 648 in the Canadian National Collection, Ottawa.

A short, compact species, having the form of *R. nigrociliatum*, and easily distinguished by the enlarged front four tarsi.

36. *Rhaphium fascipes* Meigen
(Figs. 54, 55, 56).

Length, 3.5 mm. Face and beard black; legs black, the anterior four tibiae and bases of their tarsi dirty yellowish, the posterior tibiae more than half whitish basally; middle coxae with short black spine.

Male. Face dull black, narrow, a little widened above. Front and occiput bronze green, largely obscured by brownish or brownish grey pollen. Pile of head wholly black except on upper part of eyes. Palpi black, with black hairs, not large. Antennae black; third joint two-thirds as long as face; rather wide and moderately tapering, its apex rather obtuse; arista as long as third joint. (See fig. 55).

Mesonotum bronzy green, covered with semi-obscuring greyish brown pollen; more shining sub-laterally; pleura darker except on middle part, greyish pollinose. Scutellum with four bristles.

Legs black. Coxae greyish pollinose, black pilose, the hairs fairly stout, and not very abundant on the front pair, the posterior ones with pale pile and one preapical black bristle on the outer side. Anterior four tibiae dirty yellowish, the bases of the first two tarsal joints, more or less broadly, similar, the posterior tibiae (fig. 56) yellowish white on the basal half or more, especially pale on the dorsal surface. Anterior basitarsi not noticeably enlarged apically, the hind one decidedly shorter than the second joint. Anterior femora with rather long sparse black hairs behind, the middle ones with two preapical anterior and three or four posterior bristles, the hind ones with similarly placed conspicuous hairs; posterior tibiae slightly swollen on apical half.

Wings lightly smoky, the cross-vein oblique. Squamae yellow, with fine white cilia; halteres yellow.

Abdomen bronze green, the apical segment often bluish, the whole rather thickly greyish pollinose and appearing blue-green, the hairs black; venter and sides of first three segments fine whitish pilose. Genitalia black; lamellae (fig. 54) brown, the hairs black.

Female. Face about one fourth head width, argenteous, upper section longer, lower, shorter, than wide; front rather dull brownish. Occiput chiefly grey pollinose, beard greyish white; palpi fairly large, brownish, with argenteous pollen and black hairs. Third antennal joint one and one fourth as long as wide, not large. Arista not as long as face and palpi.

Mesonotum often with slight violaceous tinge, and with narrow sub-median purplish brown vittae. Propleural and coxal pile greyish yellow, the middle coxae on outer side and apex black haired, the hind ones with the usual black bristle.

Femora black, the apices of the front four and basal third or less of the hind ones reddish; tibiae and basal half or more of front four basitarsi reddish yellow, the posterior tibiae black on apical two-fifths, the upper surface on basal portion somewhat whitish. Femoral bristles as in male. Abdomen more shining.

Described from seven males and three females from Hull, Quebec, June 4, 1923, (Curran); and 1 ♂, Niagara Falls, N.Y., May 25, 1919, (Van Duzec). Reported by Van Duzec from Alaska.

This European species has been reported from Alaska (Aldrich) by Van Duzec, who also collected specimens at Niagara Falls. I found it quite commonly along the muddy edges of a stream near Hull, 1923, and also took specimens at the Mer Bleuc, near Ottawa, in very similar situation. It apparently is an early spring species and probably occurs throughout the Canadian and Hudsonian zones. There are also three females before me from the vicinity of Lawrence, Kansas, which appear to offer no differences from typical forms.

Type probably in Paris Museum.

37. *Rhaphium fumipenne* Loew

Feet with the fore coxae altogether yellow. Long. corp. 0.18.

Female. Bright metallic-green. Face with pale yellowish-grey dust. Palpi black, with yellowish-grey dust. Antennae black; the third joint small, rounded-ovate; arista at least three times the length of the antennae. Front blue-green, with a pale yellowish-gray dust. Cilia of the upper orbit black, those of the lateral and inferior white. Thorax with a thin but rather distinct greyish-yellow dust. Fore coxae yellowish with white hair; on their tips among the white hairs there are a few black bristles, not easily perceived. Middle and hind coxae blackish with yellowish tip; the front side of the middle coxae is clothed with white hair and towards the tip with a few black bristles; hind femora blackish-brown at the tip; fore and middle tarsi infuscated, blackened towards the end; the last third of the hind tibiae and the hind tarsi black. Cilia of the pale-yellowish tegulae whitish; halteres pale-yellowish. Wings tinged with brownish-grey; the last segment of the fourth longitudinal vein gently inflected forward upon its middle.

"*Hab. Middle States.*" (Translation of original description)

There are two specimens (♂ ♀) before me, collected by Dr. J. M. Aldrich at Lafayette, Indiana. These agree quite well with the above description, but I hesitate to redescribe the species from them without an examination of the type. The general characters of the ♂ may be gleaned from the table of species.

Type in Mus. Comp. Zool., Cambridge, Mass.

38. *Rhaphium longipalpis* new species

(Figs. 57, 58, 59, 60).

Length, 3.5 mm. Differs from all described species in having the palpi somewhat crescent-shaped, elongate, silvery on the outer side and black on the inner side. The legs are black except the anterior four tibiae.

Male. Face with almost parallel sides, moderately narrow, silvery white; front bare, brilliant blue or violaceous. Occiput deep green, but covered with greyish pollen on lower two-thirds. Orbital cilia fine, black, not extending to the level of the antennae; beard abundant, white. Proboscis brown; palpi (fig. 60) shining black, silvery on the outer surface, elongate, their hair sparse, black. Antennae (fig. 58) black, the third joint more brownish, one-fourth longer than the face, tapering to a point from the base; arista brown, rather thick, sometimes slightly enlarged before the end, but this not always present; arista one fifth shorter than the third antennal joint.

Mesonotum rather blue green, moderately covered with yellowish brown pollen; lateral declivities blackish. Pleura dark green with a covering of greyish pollen. Propleura white pilose. Scutellum dark green, with four bristles.

Coxae green, greyish pollinose, white pilose, the middle ones with a rather loose white apical spine, the middle and hind ones with a black bristle on the outer side at the middle. Legs black, the anterior four tibiae yellow, the bases narrowly blackish. Femora with seven long hairs apically on postero-ventral surface, the posterior ones with conspicuous black hairs below and longer ones on the antero-ventral surface, the middle ones with very fine moderately long white hairs behind. Middle femora with a preapical bristle in front and behind, the posterior ones with one on the anterior surface only. Hair of legs black. Second joint of the anterior tarsi not half as long as the anterior basitarsus which is swollen apically.

Wings strongly tinged with brown. Squamae and halteres yellow, the former with white cilia.

Abdomen green basally, becoming bronzed on the apical half, the incisures blackish; hair black, that on the sides and venter fine, whitish. Genitalia (fig. 57) black, the basal segment green, more or less pale pollinose; outer lamellae long, triangularly broadened basally, their hairs brown, inner lamellae short, concave apically, the inner point produced, the concavity with very conspicuous yellowish hair.

Female. Face wide, the upper section distinctly wider than long; greyish white or white pollinose. Third antennal joint about twice as long as wide, acute, the arista not quite as long as the face and palpi, its basal section shorter, the whole more slender, but still more robust than usual, and there may be an indication of an apical enlargement. (See fig. 59).

Legs coloured as in male, the preapical bristles similar, the femora with wholly black short hairs. Tarsi simple. Abdomen similarly coloured.

Described from two males and two females from Colorado and Idaho, collected by J. M. Aldrich.

Paratypes—♂, Moscow Mt., Idaho, June 4, 1910; ♀, Tennessee Pass, Colo., July 10; No. 646 in the Canadian National Collection, Ottawa.

Type and Allotype—Male and female, Cat. No. 28083, U.S.N.M., from Tennessee Pass, Colo., 10240 ft., July 9.

39. *Rhaphium palpale* new species

(Figs. 60, 61)

Length, 4 mm. Third antennal joint rather narrow, as long as the face, its arista about half as long; coxae mostly and the femora and tibiae yellow, the hind tibiae darkened at apex; palpi large, pale yellow, three times as long as wide, the apex rounded.

Male. Face narrow, silvery white, slightly widened above; front bare, shining green; occiput green, greyish pollinose below, the beard not abundant, of moderate length, white. Palpi elongate, pale yellow, about three times as long as wide, their apices rounded, silvery white pollinose, with only a few delicate whitish hairs; proboscis black. Antennae (fig. 62) black; third antennal joint as long as face, slightly tapering, practically bare, the second joint broader than long, not over one-third the length of the first; arista moderately stout, about half as long as the third joint.

Mesonotum dark green; thinly brownish yellow pollinose. Pleura

dark green, thinly greyish pollinose; propleural pile whitish. Scutellum with only two bristles.

Coxae yellow, the posterior four brownish on the basal half or less exteriorly; anterior four with longish whitish hair, the hind ones with three or four yellowish bristles on the outer surface; all thinly whitish pollinose; no coxal spines. Legs yellow; posterior legs black from the apex of the tibiae, the base of their basitarsi reddish, middle tarsi black from tip of first joint, the last two or three joints of the front tarsi darkened. Legs simple, front basitarsi not enlarged apically, as long as the remaining joints combined.

Wings tinged with brown, especially so on the front half. Squamae and halteres pale yellow, the former with white cilia.

Abdomen bright dark green, the incisures increasingly more widely blackish or blackish blue apically, the last segment all of this colour, the sides of each segment with a large white pollinose spot posteriorly. Hairs black, the first three segments with yellowish pile laterally. Genitalia black, lamellae small, (fig. 61) their base yellowish, their apices black, clothed with sparse black hairs.

Type—Male, Cat. No. 28084, U.S.N.M., from Woodbury, N.J., May 14, (C. W. Johnson).

Paratype, ♂, Lahaway, Ocean Co., N.J., in M. C. Van Duzee Collection.

40. *Rhaphium foliatum* new species

Length, 5 mm. Allied to *insolitum* but the hair of the palpi is very much longer, middle femora with broad preapical blackish band, etc.

Male. Face moderately narrow (slightly widened above and below?), silvery white; front green, very slightly whitish pollinose. Occiput blackish above, whitish pollinose below; eyes emarginate behind; beard abundant, long, white. Palpi brownish, densely clothed with long, silvery white downwardly directed pile, the hairs of which are almost twice as long as the palpi. Antennae black; third joint four-fifths as long as the face, moderately tapering, the arista scarcely as long as third joint, the penultimate section apparently two-thirds as long as the ultimate, but the joint is obscure.

Thorax blue green, the mesonotum with thin brownish pollen which leaves broad, scarcely evident, almost bare stripes. Pleura whitish pollinose. Propleural pile white.

Coxae brown, the anterior pair greenish, grey pollinose; pile and bristles whitish, the middle pair with a loose apical black thorn.

Trochanters brown. Femora: anterior pair blackish with green reflections, the apex reddish yellow; middle pair yellow with broad pre-apical brown band; posterior pair yellow on basal three-fifths, brownish black on apex; tibiae yellowish, the posterior pair black on apical fourth; tarsi blackish, the basal joint of the front four yellowish except the apex. Anterior femora with long whitish hair behind and below, the middle pair with similar hair behind and below on basal three-fourths, the legs elsewhere with shorter black hair, the posterior pair with short black cilia on antero-ventral edge. Middle femora with three or four preapical bristles in front and behind near lower edge. Anterior basitarsi but slightly widened apically, longer than the remaining joints. Middle tarsi elongate, the second to fourth joints somewhat laterally compressed and much higher than thick.

Wings lightly infuscated on apical three-fifths, more strongly so in front; large cross-vein strongly oblique. Squamae and halteres yellow, the former white ciliate.

Abdomen bluish green, the bases of the segments broadly bronze-black, the apical two segments wholly blackish; green portions whitish pollinose; hair black, on the sides and venter white. Genitalia brown; the outer lamellae long, tapering, the leaf-like appendages probably shaped as in *insolitum* but only half of one of them remains; inner lamellae rather stout; appendages brownish except the adventitious inner lamellae, which are yellowish and almost as long as the inner lamellae; hairs all black.

Described from a single ♂, Sugar Grove, Ohio, May 19.

Type in collection of Mr. M. C. Van Duzee.

41. *Rhaphium insolitum* new species
(Figs. 64, 65)

Length, 4.5 to 5 mm. Third antennal joint as long as the face, the arista three-fourths as long as the joint; all the coxae blackish, front femora except each end, apex of hind femora and their tibiae and coxae wholly, black, the genital lamellae large, broad, elongate leaf-like, their edges regular.

Male. Face narrow, silvery white, slightly widened above. Front shining watery green, longer than wide. Occiput green, greyish pollinose on lower two-thirds, the beard white. Palpi small, black in ground color, silvery white pollinose, their hair abundant, rather long, fine, white. Antennae (fig. 65) black; third joint tapering to a rounded point, slightly longer than the face; arista three-fourths as long as the third joint.

Mesonotum dark green or blackish green, not pollinose; pleura

blackish green, moderately grey pollinose; propleural pile whitish. Scutellum with four bristles, the basal ones half as long as the others.

Coxae greenish black, greyish pollinose, the front ones with abundant long yellowish tinged hair, the middle ones with similar hair, a black bristle on the outer edge apically and several small apical bristles which are largely concealed by the white hair as they are much shorter; the hind ones have a strong black bristle above the middle and several longish yellowish hairs. Front femora blackish with the base and apex broadly reddish yellow, the posterior four, front four tibiae and base of the tarsi reddish yellow; hind femora with the apical fourth and remainder of the hind legs black; front four tarsi blackened almost from the base. Anterior basitarsi slightly gradually widened apically, as long as the remaining joints. Anterior femora with long pale pile behind which appears to form cilia on the posterior edge below; middle femora with a complete row of long pale cilia on postero-ventral edge; anterior femora with one posterior, the middle with two anterior and posterior, the hind with two anterior and one posterior preapical bristle.

Wings strongly tinged with brownish. Squamae and halteres yellow, the former with long whitish cilia.

Abdomen dark green, the incisures and apical segment steel blue or bronzed, the sides rather densely white pollinose. Abdomen basally on the sides and the venter whitish pilose, the hairs black. Genitalia black, the lamellae dirty yellowish, with black hairs. (Fig. 64).

Type—Male, Cat. No. 28085, from Florida (Mrs. A. T. Slosson).

Paratypes—♂, North Carolina, No. 1357, in the Canadian National Collection, Ottawa; ♂, Bladenburg, Md., May 10, 1917, in M. C. Van Duzee's collection.

This may prove to be the ♂ of *R. nigricoxa* Loew but it seems unlikely that this is the case. I had at first considered it to be so, but I feel sure that the ♂ of that species has shorter antennae than is the case here.

42. *Rhaphium melampus* Loew

(Figs. 66, 67).

Length, 4.5 mm. Legs wholly black except just the knees in both sexes; face and beard white. Genitalia moderately large, the outer black lamellae very small, the inner large, stout and reddish. Third antennal joint longer than face in male, the arista shorter than third joint.

Male. Face narrow, silvery white, slightly widened above. Front bright blue, with thin white pollen. Occiput green, with whitish pollen and short white beard. Palpi smallish, black, with silvery white pollen.

Antennae black; third joint as long as face and palpi, rather broad, moderately tapering, the arista situated on the upper, oblique apex; about three-fourths as long as the face or three-fifths as long as third joint. (See fig. 67).

Mesonotum dark green, with more or less confluent sub-dorsal bronzy brown narrow to wide vittae, and thin whitish grey pollen. Pleura more bluish green, with moderately abundant whitish grey pollen. Propleural and coxal pile whitish.

Legs black, knees narrowly reddish; anterior four femora white pollinose behind; anterior basitarsi gradually broadened from the middle, acute below at the oblique apex, laterally compressed, the following joints successively shorter and, together, but little longer than the first. Pile on front coxae dense, moderately long; on middle ones not abundant, more yellowish apically where it is condensed but does not form a spine; a row of hairs on outer side of hind coxae, the median hairs longest, all yellowish.

Wings strongly cinereous with the basal third paler, the cross-vein oblique. Squamae yellowish with fine white cilia. Halteres yellow.

Abdomen bluish green, the segmental bases increasingly more widely bronze-black, the last segment almost wholly so; hairs black, pile of venter and sides yellowish. Genitalia large, black, (fig. 66), the brown outer lamellae thickly short black haired; the inner lamellae stout, reddish, with a few pale hairs.

Female. Face silvery white, the upper and lower sections each slightly longer than wide; palpi large, black, densely argenteous pollinose; black-haired. Third antennal joint somewhat longer than wide, cordate, the arista as long as face and palpi.

Median portion of mesonotum more thickly pollinose, the dark vittae narrower. Bristle on hind coxae black. Anterior and posterior femora without preapical bristles, the middle ones normally with one anterior and one or two posterior lower ones. Wings still darker. Abdomen green or bronze green with apical one or two segments blue.

Description from four males and five females from Hull, Que., July 5, 1923, (Curran); and 1 ♂, Trenton, Ont., July 18, 1918, (Van Duzee). Also recorded from New Jersey and "Atlantic States" (Ald. Cat.).

The females of this species were found mostly along a stream where the grass was long, the males chiefly along the muddy banks where they were not rare. It is one of the most readily recognized species, in both sexes. Probably occurs in suitable situations in Northeastern States and Canada, July to August. During 1924 many additional specimens were taken in a swamp at Aylmer, Quebec, in May and June.

Type in Mus. Comp. Zool., Cambridge, Mass.

43. *Rhaphium montanum* Van Duzee

A small blackish species with blackish wings and black feet.

Male. Length, 3.3 mm. Face narrow, silvery white. Front violet with two spots of white pollen which form a transverse band near its middle. Antennae black; third joint of the usual acute triangular shape, not quite as long as the eye height; the apical arista about two-thirds as long as third joint. Lateral and inferior orbital cilia white, a few of the upper cilia black.

Thorax dark green, not very shining; pleurae dulled with whitish pollen. Abdomen bronze or coppery-brown with a little blue or greenish on the centre of the dorsum of the first and second segments, and rather long white hair on the sides of the first three segments. Hypopygium black, extending about one-half its length below the abdomen, its lamellae black, slender, rather wide at base but abruptly narrowing and tapering to a slender point, not quite as long as the third antennal joint, fringed with delicate pale hairs on both edges and with two long black hairs at tip; inner appendages small, black with a point at tip and a tuft of black hair near the base. Legs and feet black; fore and middle tibiae a little yellowish on upper surface of apical two-thirds; fore coxae with long white hair on their anterior surface; fore basitarsi widened a little at tip into a small spur, making it a little concave below, a little shorter than the remaining four joints taken together, fourth joint very short. Calypters, their cilia, and the halteres yellow.

Wings strongly tinged with blackish; third and fourth veins bent so as to approach each other beyond the cross-vein, still nearly parallel at their tips.

Female. Colour and wings as in the male. Face wide with white pollen, through which the green ground colour can be seen; third antennal joint short, a little longer than wide, triangular; the apical arista longer than the antennae. Front violet, narrowly blue or green just above the antennae and along the orbits; fore coxae with shorter hair than in the male; fore basitarsi not concave below, their tips not widened.

This species is very much like *P. mundus* Loew, but it is smaller and the female is more wholly black, the male has the lamellae long and slender, while in *mundus* they are small and rounded; the inner appendages are small in this species and altogether black, while in *mundus* they are long and yellowish; the third antennal joint is shorter in this than in *mundus*. (Original description).

Originally described from California and not since recorded.

Type in California Academy of Science, San Francisco.

44. *Rhaphium shannoni* new species
(Figs. 68, 69).

Length about 3 mm. Face silvery white, beard white; femora and hind legs black; genital lamellae long, unbranched; third antennal joint about three times as long as wide, the arista almost as long as the antenna.

Male. Face narrow, silvery white, slightly widened above. Front blackish green. Occiput green, thinly greyish pollinose; beard white; orbital cilia black. Palpi brown, rather whitish pollinose, their hair black. Third antennal joint about three times as long as wide, slightly tapering, the arista as long as the antenna, slender, the basal section thickened, twice as long as wide. (See fig. 69).

Mesonotum dark green, the broad middle portion sometimes bronzed; thinly brownish pollinose. Pleura green, greyish pollinose. Prothorax white pilose.

Coxae green or blackish, with yellow apices, greyish white pollinose, the hair long, white; no black hairs or bristles. Trochanters pale brown, femora black or brown, their bases sometimes very narrowly yellow, their apices and the four anterior tibiae and tarsi yellow, posterior tibiae and tarsi brown; last two joints of front four tarsi black. Anterior femora with fairly long pale hair behind and below, the middle ones almost bare; middle and hind femora each with an anterior and posterior preapical black bristle. Anterior basitarsus somewhat enlarged apically, two and a half times as long as the second joint; middle basitarsus with a small black ventral basal spine.

Wings tinged with brownish, darker in front, the cross-vein slightly oblique. Squamae and halteres yellow, the former with white cilia.

Abdomen dark green, thinly greyish pollinose, its hair black, the sides and venter with white hair; the incisures darker. Genitalia (fig. 68) black, the outer lamellae long, brownish yellow with brown hair, the inner lamellae slender, reddish.

Described from six males; Plummer's Island, Maryland, April 28, 1914, Dead Run, Fairfax Co., Virginia, April 19, 1914, (R. C. Shannon); Riverton, N.J.; Swarthmore, Pa., and Beverley, Mass.; Castle Rock, Pa.

Type—Male, Cat. No. 28086, U.S.N.M., from Plummer's Id.

Paratype—Dead Run, Virginia; No. 669 in the Canadian National Collection, Ottawa.

This is a very distinct species and it has a much longer arista than is found in any species which can be referred to *Rhaphium* in the strict

sense, although it could not well be placed in either of the other subgenera. The species forms a perfect link between *Rhaphium* and *Porphyrops*.

45. *Rhaphium atkinsoni* new species
(Figs. 70, 71, 72)

Length, 3.5 to 4 mm. Related to *femoratum* V.D. but the middle femora are black. Arista shorter than the long third antennal joint; front dark violet.

Male. Face moderately wide, a little narrowed below, argenteous. Front shining dark violet. Occiput dark green, greyish pollinose, the rather sparse beard white. Palpi black, elongate-triangular, argenteous pollinose, their hairs very short, black. Antennae (fig. 71) black; third joint a little longer than head-height, broad, tapering, the arista shorter than width of third joint, robust, its pubescence appressed.

Thorax dark green; mesonotum thinly brown pollinose; pleura grey pollinose. Propleural pile white.

Coxae greenish black; grey pollinose, the narrow apices reddish; their pile white; front coxae without any black bristles, the middle pair with two or three long black bristles on the anterior outer edge, elsewhere with appressed sparse black hairs and a small white apical thorn; posterior coxae with a strong black bristle on middle of outer surface and fine white hairs. Trochanters, base of middle femora, basal three-fifths of hind femora, anterior four tibiae and basal joint of their tarsi except at apex, reddish yellow, narrow apices of the anterior four femora also reddish, the legs elsewhere black. Front and posterior femora each with a single preapical bristle behind, the middle femora with two, the posterior four femora also with an anterior preapical. Anterior tarsi with stout, short black spinules on upper posterior surface between base of first and apex of the third joint, the first joint gently curved, slightly thickened apically and as long as the following three joints.

Wings lightly cinereous; and large cross-vein very slightly oblique, not half as long as last section of fifth vein. Halteres and squamae yellow, the former white ciliate.

Abdomen bronzed, the sides on basal half or more green with greyish pollen; venter black, grey pollinose. Hair of abdomen black, on the sides basally and the venter, whitish. Genitalia (fig. 70) blackish, the lamellae brown, with black hairs.

Female. Face wide, the upper section slightly wider than long; whole face densely luteous grey pollinose; palpi and proboscis with greyish brown pollen, the former large, with black bristly hairs. Beard

thinner and yellowish tinged. Third antennal joint short, triangular, one and one-half as long as wide, arista as long as face and palpi. (See fig. 72)

Posterior tibiae reddish yellow on basal three-fourths; anterior basitarsi with a row of tiny black spinules below, middle femora with a single posterior preapical bristle. Wings with slight luteous tinge.

Abdomen greenish laterally on whole length, without pale pile on the sides.

Described from 6 ♂, 4 ♀, Saskatoon, Sask., June 5, 1923, (N. J. Atkinson).

Type and Allotype—No. 1353 in the Canadian National Collection, Ottawa.

Paratypes—Male and female, Cat. No. 28087, U.S.N.M.

46. *Rhaphium temerarium* Becker

(Figs. 73, 74, 75).

Length, 3 to 3.5 mm. Antennae four times as long as wide; face white; femora black, posterior legs wholly so.

Male. Face narrow, slightly widened to the antennae, silvery white. Front purplish, more or less brownish pollinose below. Occiput green, thinly whitish pollinose; orbital cilia black; beard white. Palpi blackish, silvery white pollinose, with a few short black hairs. Antennae (fig. 74) black, the third joint four times as long as wide, tapering but not acute, the arista not over one and one-half times as long as the width of the third joint; its basal section about one and one-half times as long as wide, swollen.

Mesonotum green, the area between the dorso-centrals more or less purplish-brown or bronzed, but quite variable; thinly brownish or brownish grey pollinose. Pleura blackish, the middle green, greyish pollinose. Propleura white pilose.

Coxae green, with narrow yellow apices, their pile white or yellowish white, covered with greyish pollen. Middle coxae with three to five black bristly hairs on the outer margin of distal half, and a fairly long creamy-white thorn; posterior coxae with a long fine bristle on the outer surface beyond the middle. Trochanters yellow. Femora black, the base of each and the apex of the anterior four, yellow, or the anterior four may not have their bases yellow; anterior femora with only a few long pale hairs posteriorly at the base, the hair elsewhere black and short, except that there are a few conspicuous ones on the apex of the anterior femora postero-ventrally, but there is no distinct preapical bristle; middle

femora with one anterior, one posterior, the hind ones with one anterior preapical bristle. Posterior tibiae and tarsi black, the anterior four tibiae and basitarsi, except the tip, yellow; other tarsal joints brown. Anterior basitarsus gradually widened to the apex, twice as long as the following joint.

Wings tinged with brownish, the cross-vein slightly arcuate outwardly. Squamae and halteres yellow, the former with whitish fringe.

Abdomen dark green, largely bronzed, scarcely greyish pollinose, the hairs black, the sides and venter with dull yellowish pile. Genitalia as in fig. 73, the appendages brown, the outer with yellowish brown, the inner with dull yellowish hair.

Female. Face wide, the lower section greenish in ground colour, the upper section distinctly wider than high; wholly densely greyish pollinose. Front purple. Occiput and lower part of head grey pollinose. Palpi large, black, grey pollinose, with black hair. Third antennal joint triangular, less than one and one-half times as long as wide, the arista two nad one-half times as long, the basal section twice as long as wide. (See fig. 75)

Mesonotum darker, more thickly and evenly brown pollinose. Anterior coxae with two or three strong black hairs apically; middle coxae with the hairs on nearly the apical half strong, black, and two or three fine bristles on the outer margin. Femora coloured as in male, but the hind ones with the apical fifth or more, (on the under surface one-third) yellow, the preapical bristles as in the male. Posterior tibiae reddish, the apical fourth black, the base ferruginous or brownish. Anterior four tibiae yellow, their tarsi paler, the first two joints reddish, with brownish apices, the remainder brownish, often with paler bases. Wings usually strongly tinged with brown.

Re-described from type ♂ and 19 males and 15 females collected by Dr. J. M. Aldrich, Tennessee Pass and Marshall's Pass, Colorado, in July.

Type in Vienna Museum.

47. *Rhaphium triangulatum* Van Duzee

(Fig. 76).

Male. Length, 2 mm. Face very narrow, in the type the eyes seem to touch in the middle of the face; below, it has silvery white pollen. Front blackish. Antennae black; third joint as long as the head-height, about as wide at base as the width of the front and tapering a little towards the top; arista thick, not much longer than the width of the third joint at base. Lateral and inferior orbital cilia white.

Thorax shining green; pleura dulled with white pollen.

Abdomen green with bronze reflections. Hypopygium black with rather long black hair; the outer lamellae (fig. 76) yellowish, with upper edge black and fringed with pale hairs; they are triangular with a stem at base; inner appendages very small.

Fore coxae pale yellow, a little blackened at base, their anterior surface covered with long white hair; I cannot see any black bristles or hairs at tip. Middle and hind coxae black, narrowly yellow at tip, the former with three black bristles near the tip on outer surface, the latter with one black spine at tip. Femora yellow, the hind ones a very little blackened above at tip and with one preapical bristle. Middle femora with two preapical bristles, one on each side, and ciliate below with long yellow hairs on posterior edge, which are longer than femoral width. Fore and middle tibiae yellow, each with several bristles on upper surface; hind tibiae brownish yellow. Fore tarsi about as long as their tibiae, black from the tip of the first joint, which is not quite as long as the remaining four joints taken together. Middle tarsi a little longer than their tibiae, infuscated from the tip of the first joint, the base of the joints still paler, their tips blackish. Hind tarsi brown, their first joint a little shorter than the second. Calypters, their cilia and the halteres, yellow.

Wings greyish; beyond the cross-vein the third and fourth veins are a little arched so as to separate and then approach each other, still they are nearly parallel towards the tips, the fourth ending in the apex of the wing; last section of the fifth vein more than four times as long as the cross-vein; sixth vein nearly parallel with the margin of the wing, the wing being narrowed at base.

Described from one male taken at Oak Creek Canyon, Arizona, in August, at 6,000 ft. elevation, by F. H. Snow. *Type* in the author's collection. (Original description)

48. *Rhaphium femoratum* Van Duzee
(Figs. 77, 78)

Male. Length, 2.8 to 3 mm. Face narrow, of nearly equal width, silvery white. Palpi black, their tips with white pollen like the face. Front violet. Antennae (Fig. 78) black; third joint fully as long as the height of the head, rather broad at base, gradually tapering; arista as long as the width of the front at vertex. Upper orbital cilia black, the white beard long and abundant.

Thorax and scutellum dark shining green with just the suggestion

of a broad median vitta of blackish or violet; pleura with thin grayish white pollen.

Abdomen metallic green, more blue on the sides, sometimes almost wholly coppery, with conspicuous white hairs on the sides and venter. Hypopygium (fig. 77) black with stiff black hairs; the outer lamellae lanceolate, black, more or less yellow at base, fringed with rather long pale hairs, some of which appear nearly black; inner appendages small, black, somewhat shovel-shaped, rather obliquely truncate at tip, with a pale stout bristle at the acute apical corner and a few stiff hairs back of this spine.

Fore coxae black with about apical half yellow, their anterior surface covered with long white hairs; middle and hind coxae black with narrow yellow tips, the former with two long black bristles on outer surface and with a few long yellowish bristles at tip, which do not seem to form a spine as they usually do in this genus; hind coxae with one large black bristle and a few minute white hairs on outer surface. Fore femora black with extreme base and tip yellow; middle femora wholly yellow, with three preapical bristles, one in front and two on posterior side; hind femora yellow with apical half or two-fifths black, this black extends nearly to basal third on upper edge; they have one preapical bristle; all femora with short black hairs, no longer ones below. Fore and middle tibiae wholly yellow, each with several bristles above; hind tibiae wholly black. Fore and middle tarsi about as long as their tibiae, infuscated from the tip of the first joint, which is nearly as long as the remaining four taken together; hind tarsi scarcely as long as their tibiae, wholly black, slightly compressed, with the first and second joints of nearly equal length. Calypters and halteres pale yellow, the former with whitish cilia.

Wings greyish; third and fourth veins approaching each other a little and then parallel for a short distance at tip, the fourth ending in the apex of the wing; last section of fifth vein three times as long as the cross-vein and reaching the wing margin; sixth vein very close to the wing margin and nearly parallel with it, the wing being much narrowed at base.

Female. Face wide, green, thickly covered with grey pollen, divided near its middle by a suture, below which the ground colour shows through a little; palpi large, black with grey pollen and black hairs; proboscis black; front violet edged with blue; antennae black, third joint elongate triangular, nearly twice as long as wide, arista thick, apical; a little longer than the antennae, its first joint short; the white beard very thin. Body colour about as in the male; coxae, fore and middle femora, their tibiae and tarsi about as in the male, except that the fore coxae are

mostly blackish and all coxae have shorter white hair. Hind femora yellow with apical fifth black; hind tibiae yellow with about apical third black; otherwise about as in the male.

Described from nine males and six females which I took at Wells, Nevada, June 6, 1915; several males and females taken by J. S. Hine, at Kodiak, Alaska, in June, 1917, and fifteen males and seven females taken by J. M. Aldrich, in Alaska in 1921; eight taken at Skagway, June 4; ten at Anchorage, June 10 to 13; three at Fairbanks, July 1, and one at Healy, June 21.

The *holotype* and *allotype* were taken at Wells, Nevada, and are in the author's collection. (Original description)

The only specimens I have seen, other than three paratypes in the Canadian National Collection, are five ♀, Alberta, June to August.

Paratypes—Males and females, Cat. No. 26535, U.S.N.M., from Fairbanks, Anchorage, and Skagway, Alaska.

49. *Rhaphium pollex* Van Duzee

(Fig. 79).

This form differs from the above described male, *femoratum*, in the inner appendages of the hypopygium (fig. 79), having a thumb-like projection on their lower edge near the middle; the fore coxae also seem to be less yellow at tip. The third antennal joint of what seems to be the female is slightly shorter than that of the female described above.

Described from two males and five females which I took at Wells, Nevada, June 6, 1915; one male taken by Mr. Cole at Hood River, Oregon, June 21, 1917; several specimens taken by Prof. James S. Hine, at Kodiak, Alaska, in June, 1917, and one male taken by J. M. Aldrich, at Skagway, Alaska, June 4, 1921.

Holotype and *allotype* in the author's collection and taken at Wells, Nevada.

The male of *femoratum* differs from that of *xiphres* Wheeler in having the inner appendages of the hypopygium more shovel-shaped, not at all club-shaped, and in having the hind femora much more blackened at tip. Wheeler's species is from the East, these forms from the West. (Van Duzee).

I feel certain that the females included with the above males all belong to *femoratum*. The males of the two species are very similar in general appearance, but the front coxae are almost all green in mature specimens and the third antennal joint is a little larger. Females taken by Dr. Aldrich together with males at Juliaetta, Ida., are very distinct

from those of *femoratum*, having the third antennal joint *twice as long* as in that species and the arista hardly as long as the apical two antennal joints.

Paratype—Male, Cat. No. 28093, U.S.N.M.

50. *Rhaphium xiphères* Wheeler
(Fig. 80).

The following is a copy of Prof. Wheeler's description; I have not seen any specimen of this form.

Male. Length, 3.5 mm.; of wing, 3 mm. Palpi small, dusted with white. Face broad for a male, covered with silvery white dust. Antennae (fig. 80) black; first and second joints short, third joint flattened, as long as the thorax, slowly tapering to the tip and covered with short and almost imperceptible pile; arista terminal, very short pubescent, its basal segment somewhat thickened. Front black, rather opaque. Postocular cilia abundant, snow white. Thorax and scutellum blackish metallic green, the latter with bluish reflections. Abdomen dark metallic cupreous green; edges of the segments black; basal segments bearing long pale hairs on their sides. Hypopygium shining black, with protruding appendages; lamellae triangular, tapering, covered with erect hairs, black, each with a small white spot at its base; internal appendages club-shaped. Pleura thickly covered with gray dust, except above the base of the middle coxae where the metallic green ground-colour is exposed. Coxae concolorous with the pleura, only their extreme tips yellow; anterior surfaces of fore coxae clothed with conspicuous silvery white hairs. Middle coxae each with a tuft of similar hairs and a couple of stout, curved, black bristles. Legs plain, yellow, anterior tarsi from the tip of the first joint, the hind tibiae, which are somewhat incrassated, hind tarsi and the hind femora on their upper surfaces near the tip, black. Wings greyish hyaline, not narrowed towards their base; veins brown; third and fourth veins nearly parallel. Halteres and tegulae yellow, the latter with long white cilia.

Delaware County, Pennsylvania.

Type in American Museum of Natural History, New York.

51. *Rhaphium coloradense* new name
(Fig. 81)

Xiphandrium longicornis V. Duz., Tr. Am. Ent. Soc., XLVIII, 85, (nec. Loew)

Male. Length, 3 mm. Head rather small. Face very narrow, silvery

white, in the type the eyes touch in the middle of the face, probably because the head is shrunken. Palpi and proboscis black. Antennae black, its white pubescence conspicuous; third joint very long, nearly as long as the abdomen; in the type it is wavy, like a ribbon, of nearly equal width for nearly its entire length; arista short and thick, but as long as the width of the front. Front greenish, very short, not much more than a line and without bristles. Orbital cilia and beard white; I cannot see any black cilia above.

Dorsum of thorax and the scutellum shining green; pleura slightly dulled with whitish pollen. Abdomen green with coppery reflections, the lower portion of its sides with pale hairs. Hypopygium (fig. 81) black, without hair, but with scales of pollen; its lamellae developed into long ribbon-like black filaments, which are fringed with long bristly hairs; the inner appendages are also long filaments with long bristles at tip, enlarged a little at base.

Fore coxae wholly yellow; middle and hind ones black with yellow tips; fore and middle pairs with yellow hairs on their anterior surface, hind pair with yellow bristle on the outside; middle ones with a yellow spine at tip. Femora yellow, nearly bare below; posterior pair a little infuscate near the tip above. Tibiae yellow with only very small bristles; posterior tibiae slightly infuscated at tip. Fore and middle tarsi slightly longer than their tibiae, infuscated from the tip of the first joint; fore metatarsi as long as the following four joints taken together and with a row of minute bristles below. Hind tarsi scarcely as long as their tibiae, black from the tip of the first joint, which is dark yellowish and about as long as second joint. Calypters, their cilia and the halteres, yellow.

Wings greyish; last section of fourth vein bent near its middle, where it is quite widely separated from third vein, the third vein running rather close to second as far as this point, from this point the third and fourth veins approach each other a little, then run nearly parallel to their tips, the fourth ending in the apex of the wing; last section of fifth vein about two and one-half times as long as the cross-vein; sixth vein quite widely separated from the wing margin, the anal angle of the wing being somewhat prominent.

Described from one male, taken by L. O. Jackson, at Geneva Park, Grant County, Colorado, July 23, 1910, at an elevation of about 9,000 feet. *Type* in the author's collection.

Perhaps a new genus should be formed to receive this species, based on the small front and its lack of bristles, but as it is possible that the bristles may have been broken off in the single specimen we have, it

seems best to wait until more material is found. Otherwise it fits well in this genus. (Original description)

51A. *Rhaphium aldrichi* Van Duzee

(Figs. 82, 83)

Male. Length, 2.75 to 3 mm. Face white, not very narrow. Front green, dull. Palpi blackish or yellowish brown, small. Antennae black, nearly twice as long as the height of the head; third joint of about equal width, ribbon-like, somewhat folded up, pubescent; arista very short, scarcely as long as the width of the third joint. Lateral and inferior orbital cilia white.

Thorax green, dulled with grey pollen. Abdomen green with black hair, those on the lower edge of the sides yellow. Hypopygium and its appendages black; there are two pair of lamella-like appendages (figs. 82 and 83), these do not seem to be united at base, but I do not see that either can be called an outer or inner appendage as in other species; one is long and furnished with long pale hairs, the other pair have an oval tip tapering into a slender stem, these also have long pale hairs.

Fore coxae yellow, slightly darker on outer side at base; middle and hind coxae black on basal, yellow on apical half; the hairs and bristles of all coxae yellow. Femora and tibiae yellow, only the tips of posterior tibiae brown, their bristles very small. All tarsi blackened from the tip of the first joint; fore tarsi about as long as their tibiae, the first joint but little longer than the second: middle pair one and one-fourth times as long as their tibiae, hind tarsi slightly thickened, about equal to their tibiae in length, first and second joints of about equal length. Calypters, their cilia and the halteres, yellow.

Wings grey; third and fourth veins approaching each other from about the middle of the last section of the fourth vein, but nearly parallel at tips, fourth ending in the apex of the wing; last section of fifth vein fully twice as long as the cross-vein; anal angle rounded, the wing being rather abruptly narrowed at its root.

Female. Colour, venation and form of the tarsi about as in the male. Face wide, whitish; palpi black, large; antennae with the third joint somewhat triangular, but little longer than wide; arista about as long as the height of the head, slender.

Described from two males and one female, taken at Healy, Alaska, June 24, 1921, by J. M. Aldrich, for whom I am naming this interesting species. *Type* and *allotype* in the United States National Museum. (Original description)

Type and *Allotype*—Male and female, Cat. No. 26536, U.S.N.M.

52. *Rhaphium exile* new species
(Figs. 84, 85)

Allied to *femineum* V.D. from which it is distinguished by the presence of a long bristly black hair at the apex of the outer lamellae.

Length, 2.5 mm. *Male*. Face rather narrow, tapering to lower edge, silvery white. Front violaceous, bluish on the edges. Occiput dark green, rather thinly whitish pollinose, upper orbital cilia black; beard white, rather sparse. Palpi brownish yellow, white pollinose and with a few fine whitish hairs. Third antennal joint ribband-like, much longer than height of head, the arista but little longer than width of third joint, densely pubescent. (See fig. 85)

Mesonotum blackish green, rather densely brown pollinose, but quite shining; scutellum more or less violaceous, the basal pair of bristles very small. Pleura green, the posterior margin yellow, greyish pollinose.

Coxae and legs yellow; posterior femora slightly darker yellow with the upper surface brownish except on basal fourth to one-half, the posterior tibiae and tarsi wholly black. Anterior tarsi simple; middle tarsi slightly darkened apically. Anterior and posterior femora each with one posterior preapical bristle, the middle pair with two, the middle and posterior femora each with one anterior preapical. Coxae with white hair, the middle pair with two black bristles on outer anterior edge and a slender yellowish thorn at apex, the hind pair with an exterior black bristle.

Wings lightly infuscated, especially in front. Squamae and halteres yellow, the former whitish ciliate.

Abdomen bronzed, the base and sides apple-green and thinly greyish pollinose. Hairs black; on the sides and venter pale. Genitalia brown, the lamellae (fig. 84) brown, with black hairs, sometimes pale brown basally.

Described from 4 ♂ specimens, Lafayette, Indiana, July 18, 23, 25 (J. M. Aldrich).

Type—Male, Cat. No. 28088, U.S.N.M.

Paratypes—No. 1354 in the Canadian National Collection, Ottawa.

53. *Rhaphium femineum* Van Duzee

Length, 2.5 to 2.75. Small, slender species, the third antennal joint over five times as long as wide, the arista not over one fifth as long; coxae yellow, the posterior four sometimes infuscated on outer side, the posterior tibiae and tarsi black, front four legs yellow.

Male. Face fairly wide, twice as wide above as below, silvery white.

Front purple with bright blue margins. Occiput blue green, densely greyish white pollinose, less thickly so above, orbital cilia black, the beard white, not abundant. Proboscis and palpi brownish yellow, the latter white pollinose, its sparse hair very fine and indistinct, greyish. Third antennal joint apparently about six times as long as wide, normally not much tapering, the arista one and a half times as long as the width of the third joint, its basal section one and a half times as long as wide, not or but little thicker than the apical section. The third joint is very evidently pubescent.

Mesothorax dark green, blue or blackish, more or less bronzed, moderately brownish pollinose, the scutellum sometimes green, blue or purple. Pleura brownish, sometimes with green reflections, the posterior edge on the lower half sometimes yellow, the whole densely whitish pollinose. Propleura white pilose.

Coxae yellow, the posterior four often more or less reddish brown on the outer surface, sparsely white pilose; the anterior coxae lack any black hairs, the middle ones have two black bristles and sometimes two or three hairs on the anterior outer edge and a slender long yellow thorn, the hind coxae with a black bristle near the middle of the outer surface. Legs yellow, the posterior tibiae and tarsi and the last four joints and tip of the first joint of the remaining tarsi blackish, the posterior femora ferruginous or brownish on the apical fourth at least above, the ventral surface always pale. Middle femora with one anterior and two posterior, the hind with one anterior preapical bristle, none with long hairs; anterior basitarsi simple, four-fifths as long as the remaining joints.

Wings tinged with brownish, strongly so anteriorly, the cross-vein slightly oblique. Squamae and halteres yellow, the former with white cilia.

Abdomen green, scarcely pollinose even on the sides, usually almost all bronzed, the hair black, only a few pale hairs basally on the sides. Genitalia concolorous with abdomen, the small outer lamellae brown, with brown hair.

Female. Face rather bluish in ground colour, silvery greyish pollinose, wide, somewhat widened above, the upper part not longer than wide. Front blackish, in the middle silvery greyish pollinose. Occiput blackish, densely white pollinose except the large upper corners. Palpi brown, with slightly paler apices, whitish pollinose, the hairs black. Third antennal joint small, hardly twice as long as wide, the arista slightly longer than the face.

Broad margins of the mesonotum blackish bronzed, with brownish pollen, the disc and scutellum densely greyish pollinose, leaving dark

vittae between the acrostical and dorsocentral bristles, the anterior corners of the scutellum dark.

Legs as in ♂, the anterior coxae with one or two black bristles apically, the posterior tibiae chiefly brownish yellowish, or decidedly paler than in the male. Wings darker, the veins much more clouded with deeper brown. The middle femora lack the smaller, subventral posterior preapical bristle.

Re-described from nine males and two females from Lafayette, Indiana, May, July and August, (J. M. Aldrich).

54. *Rhaphium flavicoxa* Van Duzee

"*Male*. Length, 2 mm. Face very narrow below, wider above, silvery white. Front shining violet. Antennae black; third joint scarcely as long as the height of the head and not much wider at base than the width of the front; arista about as long as the width of the front. The orbital cilia seem to be wholly black (I can only see two or three of the lower ones).

"Thorax greenish. Abdomen green with bronze reflections. Hypopygium black with four black hairs above, its lamellae small, triangular with a stem, yellowish at base, apical half black, fringed with minute pale hairs; I cannot see any inner appendages.

"Coxae yellow; anterior and middle ones with yellow hairs on the front surface, the latter with a short yellow spine at tip and two or three black bristles on outer surface near the tip; hind coxae with one black bristle. Femora yellow, nearly bare below; middle ones with one small black bristle on each side near tip; hind pair with one preapical bristle; fore and middle tibiae yellow, the former with minute bristles and the latter with large ones. Hind tibiae brownish. Fore and middle tarsi a little longer than their tibiae, first joint as long as the following three joints taken together, yellow, becoming darker from the tip of the first joint. Hind tarsi black, with the second joint a little longer than the first. Calypters, their cilia and the halteres, yellow.

"Wings tinged with yellowish brown; fourth vein nearly parallel with third from near the cross-vein, ending in the apex of the wing; last section of fifth vein about three times as long as the cross-vein; sixth vein short, parallel with the margin of the wing.

"Described from one male taken at Lavender, Floyd County, Georgia, August, 1910, by J. C. Bradley. Type in the author's collection. (Original description)

55. *Rhaphium arboreum* Curran

(Fig. 86).

Length, 3 mm; antennae .8 mm. Allied to *R. flavicoxa* Van Duzee, but differing in the genital lamellae, which are composed of two elongate branches in *arboreum* but are triangular and unbranched in *flavicoxa*. The posterior tibiae are chiefly yellow in *arboreum*, but brown on inferior side almost to the base; chiefly brownish in *flavicoxa*.

Male. Face silvery white, narrowest at upper third, not as wide below as above. Front bluish with a narrow green margin, but so densely covered with silvery white pollen as to practically conceal the blue colour, although it is quite apparent in the newly captured specimens. Occiput green, largely white pollinose, the cilia black to the level of the antennae, white below. Antennae black; third joint one-fifth longer than height of head, very slightly tapering, distinctly pubescent; arista slightly longer than basal width of third joint, very shortly pubescent. Palpi and proboscis brownish, the former with black hairs.

Mesonotum green with slight brassy reflection, thinly greyish yellow pollinose. Before the base of the wings is a triangular opaque black spot reaching the suture, before which the sides are white pollinose. Pleura usually purplish or blue-green with rather thick whitish pollen. Basal scutellar bristles very small, inconspicuous, white.

Legs, including the coxae, whitish to yellow, the front four tarsi from the apex of the first joint and the posterior tarsi wholly, blackish or brown, the posterior basitarsus paler on basal half in many specimens, the posterior tibiae more or less infuscated on apical fourth, sometimes more on the ventral side, often scarcely so on dorsal surface, but they appear wholly darker than the others because of the abundant black hairs. Middle coxae usually with a basal fuscous spot, this sometimes extending over half way to the apex. All the coxae white-haired, the legs wholly appressed black pilose. On the postero-ventral surface of the front femora are four or five increasingly longer, small black bristles, the middle femora with one preapical bristle on either side, and sometimes two or three longer black hairs near it, the posterior femora with one anterior preapical bristle, the hairs towards the base on the dorsal surface longer than elsewhere. Anterior basitarsi not swollen at apex; first joint of hind tarsi slightly shorter than the second.

Wings cinereous, slightly darker apically in front. Squamae yellow with yellowish cilia, one or two often black. Halteres yellow.

Abdomen brassy green, the sides not very broadly thinly white pollinose; pile black, white at the sides on basal half and on the venter. Genitalia black, outer lamella yellow basally, sometimes brownish yellow,

the apical three-fourths or more usually black; at its basal fourth it is split into two nearly equal ribbon-like appendages which are about five times as long as wide, and fringed with rather long, sparse, yellow hairs, their apex rounded. They vary slightly in width and shape, sometimes being widest at the middle, at other times their sides almost parallel. The inner lamellae are usually hidden, they are nearly as long as the outer, their base apparently somewhat triangular, produced forward at their apex as a short, apically swollen prong. (See fig. 86)

Female. Face with parallel sides, nearly as wide as the length of the antennae, silvery white; front as in ♂; third antennal joint not longer than first, cordate, as wide as long, its arista four-fifths as long as height of head. Palpi with silvery-brownish pollen and black hairs.

Posterior tibiae wholly yellow, their basitarsi yellow, except apically. Abdomen coloured as in ♂.

Originally described from Megantic, Que., and not since recorded.

The pale coxae and shape of the genital lamellae at once distinguish this pretty little species from its allies.

R. arboreum apparently is a wood species. I found it in the vicinity of a small stream in a very dense and tangled wood on the shores of Lake Megantic. It was found most commonly on a leafy muddy slope, where it was extremely difficult to locate owing to its minute size. It was not possible to sweep owing to the underbrush. Shortly after, I located it again further up the side of the hill, where it was sunning itself on leaves, but failed to capture specimens by sweeping. Only in these two moist spots was it in evidence and it was taken at no other place, although I searched for it whenever I came to what I thought might be its habitat.

Type in Canadian National Collection.

Paratypes—Male and female, Cat. No. 26500, U.S.N.M.

56. *Rhaphium simplicipes* new species
(Figs. 87, 88)

Length, 3 mm. Antennae longer than head and thorax; outer genital lamellae each composed of two long slender branches; legs yellow, the hind tarsi wholly black.

Male. Face normally rather wide, slightly wider above, silvery white, the front similar, green towards the vertex. Occiput green, greyish pollinose, the beard white, not abundant. Palpi brown, with some whitish pollen and black hairs. Antennae (fig. 88) as long as the head and thorax together, the third joint very slightly tapering, the arista one and

a half times as long as the width of the third joint, which is noticeably pubescent.

Mesonotum green, with sub-median bronze vittae; moderately covered with yellowish brown pollen. Pleura green and blackish, with greyish pollen. Propleura white pilose.

Anterior coxae reddish yellow, with a black spot on the outer side at the base; posterior four coxae green with yellowish apices, grey pollinose, and white pilose, the hairs at the apex of the middle coxae condensed but not forming a distinct thorn, those on the hind coxae forming a row on the outer surface.

Legs yellow, the hind femora slightly darkened above towards the apex, the posterior tarsi wholly black, or slightly paler at the base, the apex of the tibiae and the anterior four tarsi from the tip of the first joint reddish brown. Hair on legs all black; not conspicuous. Legs entirely simple.

Wings greyish, darker in front, the cross-vein transverse. Squamae and halteres pale yellow, the former with whitish cilia.

Abdomen green, often almost all bronzed, not pollinose, the hair black, pale on sides basally and on the venter. Genitalia black (fig. 87), the outer lamellae brown with brown hairs.

Female. Face nearly one-third the width of the head, grey pollinose; third antennal joint sub-cordate, but little longer than wide, the arista longer than the face.

Legs sometimes darker, the femora rather extensively tinged with brown, the tarsi black instead of brownish; middle femora with anterior and posterior, the hind ones with anterior preapical bristle.

Described from seven males and two females, Tennessee Pass, Colo., 10,240 ft., July 10 and 11, (J. M. Aldrich).

Type and Allotype—Male and female, Cat. No. 28089, U.S.N.M.

Paratypes—same data; No. 1355, in the Canadian National Collection, Ottawa.

57. *Rhaphium lugubre* Loew

Female. Greenish-black, shining; feet black; the four anterior tibiae and the middle femora dusky yellow. Long. corp. 0.16. Long. al. 0.16.

Of a bright metallic, but very dark greenish-black colour. Face moderately broad, with a bright lustre of silvery-white powder upon black ground. Palpi black with white powder. The black antennae very long, narrow and glabrous; the apical bristle short and bare. Front shining black. Cilia of the upper orbit black, delicate, short; cilia of the

lateral and inferior orbits white. Thorax bright, with an almost imperceptible grey-whitish dust. The scutellum has no hair with the exception of the usual bristles. Abdomen bright, only on the lateral margin with distinct white powder; the hair upon it is black. Coxae black with white dust; the front side of the fore coxae with white hair and black bristles. Anterior femora black with luteous tip; fore tibiae luteous, only with two bristles on the upper side; fore tarsi black, the first joint as far as the tip, luteous. Middle feet luteous, tarsi from the tip of the first joint blackened. Hind feet entirely black, only the knees yellow; the first joint of the tarsi scarcely a little longer than the second. Cilia of the brown tegulae whitish. Wings blackish, on the fore margin and along the veins darker; the last segment of the fourth longitudinal vein only in the middle gently inflected forward.

Hab. Carolina. (Translation of original description)

Two ♀, Delaware Co., Pa., are quite evidently this species. The ♂ is not known.

Type in Mus. Comp. Zool., Cambridge, Mass.

58. *Rhaphium occipitale* new species

Length, 3.5 mm. Legs reddish yellow, the last two and one-half tarsal joints brownish; third antennal joint slightly longer than the face, the arista scarcely half as long as the joint.

Female. Face one-fourth the head width, silvery white; front blackish bronzed; occiput similar, with V behind the ocelli and the sides and lower portion pale greyish pollinose, the beard not abundant, silvery white. Palpi brown, with yellowish grey dust and a few rather fine yellowish hairs. Antennae black, as above, the third joint scarcely tapering, the end conspicuously narrowed.

Thorax bronzy black, the broad sides and middle line bare, elsewhere rather densely brownish yellow pollinose, in some lights the narrow middle line is pollinose leaving two conspicuous vittae between the dorsocentral and acrostical bristles, the latter in two regular paired rows. Pleura and coxae grey pollinose. Propleural pile white. Scutellum with only two bristles.

Anterior coxae and apices of the other four yellow, the front ones with fine white hair, and two or three black bristles on the outer apex, the middle ones with short black bristly hairs and two apical bristles on outer side, the hind ones with a single exterior bristle. Legs reddish yellow, the apical two and one-half tarsal joints brownish; front tarsi simple, the first joint of the front tarsi as long as the remaining ones,

Preapical bristles present only on the anterior and posterior surfaces of the middle femora and single.

Wings tinged with brownish. Squamae and halteres yellow, the former with white cilia.

Abdomen concolorous with thorax, the broad apices, more widely so laterally, rather bright green and very conspicuously whitish pollinose. All the hair black.

Described from a single female specimen from Opelousas, La. (Pilate), in Aldrich Collection.

Type—Female, Cat. No. 28090, U.S.N.M.

This species appears so well marked that I do not hesitate to describe it from the female sex. Like *R. indecisa* it is intermediate between *Rhaphium* s.s. and *Porphyrops* s.s. The male evidently has the fore basitarsi swollen apically and may have the apical tarsal joints distinctly flattened.

59. *Rhaphium impetuum* new species
(Figs. 89, 90, 91).

Length, 4.5 mm., antenna 1 mm. Antennae of both sexes over five times as long as wide; face white; colour very dark green; front femora and hind legs black; lamella simple, short.

Male. Face of medium width, silvery white, slightly widened above. Front and occiput black-green, the latter lightly whitish pollinose below; orbital cilia black, the thick beard white. Palpi black, with some whitish pollen, hairs black. Antennae (fig. 90) longer than the height of the head, the third joint slightly tapering, the stout arista not longer than the width of the third joint.

Mesonotum black-green, thinly greyish white pollinose, the pollen leaving obscure vittae along the rows of bristles. Pleura green, greyish pollinose. Propleura white pilose.

Coxae green, greyish pollinose, the tips of the middle ones narrowly reddish, the pile wholly whitish, the hind coxae with a row of long, strong, white hairs on the outer surface; none with bristles or thorn. Front four trochanters yellow, the middle legs, anterior tibiae and basitarsi of the front four legs, except the apex of the latter, yellow, the anterior four tarsi brownish, the anterior femora and posterior legs black. Anterior femora with rather long white pile behind and below; middle femora with a row of long ciliate white hairs on basal half of ventral surface and a row of short black hairs on the apical half or less of the antero and dorso-ventral surfaces. Anterior basitarsus three times as long as the following joint, somewhat enlarged apically.

Wings tinged with brown, the cross-vein almost rectangular. Squamae and halteres yellow, the former with whitish cilia, the latter with brownish stems.

Abdomen black green, greyish pollinose, the incisures and terminal segments blackish. Genitalia black, the short lamellae (fig. 89) brown, with black hairs, the inner lamellae yellow.

Female. Face of medium width for σ , argenteous white, the upper poriton one and one-half times as long as wide. Occiput greyish pollinose except above. Palpi brown, their apices obscurely reddish, their hair black, the whole greyish pollinose. Third antennal joint narrower than in male, its arista one and one-half times as long as the width of the joint in the middle. (See fig. 91)

Apical fifth of front femora reddish, the front coxae with one or two black hairs on the anterior outer edge, and several on the front surface towards the end laterally, the hind coxae with a row of black bristles on exterior surface. Middle femora with a row of three to five black preapical bristles on either surface above the lower edge.

Wings quite strongly cinereous, especially in front.

Described from two specimens from Plummer's Island, Maryland, April 24th, 1913, collected by R. C. Shannon.

Type and Allotype—Male and female, Cat. No. 28091, U.S.N.M.

CATALOGUE OF THE NEARCTIC SPECIES OF RHAPHIUM

- albibarba* Van Duzee, Pr. U.S.N.M., lxiii, Art. 21, p. 10, 1924. (Porphyrops).
Antea, p. 110.
- aldrichi* Van Duzee, Tr. Am. Ent. Soc., xlviii, 86, 1922. (Xiphandrium).
Alaska.
Antea, p. 164.
- arboreum* Curran, Can. Ent., lvi, 140, 1924. Que.
Antea, p. 168.
- armatum* Curran, Can. Ent., lvi, 136, 1924.
Antea, p. 111.
Que., N.Y.
- atkinsoni* Curran, Antea, p. 156. Sask.
- banksi* Van Duzee, Antea, p. 109.
- barpipes* Van Duzee, Ent. News, xxxiv, 239, 1923. (Porphyrops). Maine.
Antea, p. 112.

- boreale* Van Duzee, Ohio Jour. Sci., xxiii, 246, 1923; Proc. U.S. Nat. Mus., Vol. 63, Art. 21, p. 9, 1924. (Porphyrops).
Alaska.
Antea, p. 102.
- brevicornis* Van Duzee, Ent. News, xxxiv, 242, 1923. (Porphyrops).
Oregon.
Antea, p. 120.
- brevilamellotum* Van Duzee, Antea, p. 119.
- campestre* Curran, Can. Ent., lvi, 133, 1924.
Antea, p. 122.
Man., Alta., B.C.
- canadense* Curran, Can. Ent., lvi, 137, 1924.
Antea, p. 136.
Que.
- caudatum* Van Duzee, Antea, p. 117.
- coloradense* Curran, Van Duzee, Tr. Am. Ent. Soc., xlviii, 85. (Xiphandrium longicornis, nec. Loew).
Antea, p. 162.
Colo.
- consobrinum* Zett. See discolor Zett. Scand.
- crassipes* Meigen, Syst. Besch., iv, 50. (Porphyrops).
Zett., Ins. Lapp., 505 (cylindrica), 1838.
Meig., Syst. Besch., vii, 151. (Porphyrops fulvipes), 1838.
Beck., Nova Acta, ciii, 216, 1918.
V. Duz., Pro. U.S.N.M., lxxviii, Art. 21, p. 7, 1923.
Antea, p. 125.
Europe, N.A.
- discolor* Zett., Ins. Lapp., Dipt., 704, 1838.
Zett., Ins. Lapp. Dipt., 704, 1838. (R. fascipes var. b.).
Zett., Dipt. Scand., ii, 471, 1843 (consobrina).
Walk., List i, 210, 1851 (fulvipes).
Lichtw., D.E.Z., 182, 1896.
V. Duz., Pr. U.S.N.M., lxxiii, Art. 21, p. 7, 1924.
Antea, p. 118.
- dubium* Van Duzee. See femineum. N.Y.
- efflatum* Wheeler, Proc. Calif. Acad. Sci., ii, 34, pl. II, Figs. 54, 55.
(Porphyrops).
Wheel., Psyche, p. 361, 1890. (Porphyrops longipes Lw.).
Antea, p. 142.
Widespread.

- elegantulum* Meigen, Syst. Besch., iv, 51, 1824. (Porphyrops).
Curtis, Brit. Entomol., viii, 541, tab., 1835. (Porphyrops wilsoni).
Beck., Nova Acta, ciii, 218, Synonymy, 1918.
V. Duz., Proc. U.S.N.M., lxiii, Art. 21, p. 6, 1923.
Antea, p. 133.
- exile* Curran, Antea, p. 165. Colo.
- fascipes* Meigen, Syst. Besch., iv, 54, 1824. (Porphyrops).
Haliday, Zool. Journ., v, 354, 1832. (Perinthinus).
Macquart latipes, Rec. Soc. Sc. Agr., Lille, 247, 1827.
Becker, Nova Acta, ciii, 219, Synonymy, 1918.
Antea, p. 146.
Europe.
- femineum* Van Duzee, Tr. Am. Ent. Soc., xlvi, 84, 1922. (Xiphandrium).
V. Duz., Tr. Am. Ent. Soc., xlvi, 85, 1922. (var. dubium).
Antea, p. 165.
N.Y.
- femoratum* Van Duzee, Tr. Am. Ent. Soc., xlvi, 81, 1922. (Xiphandrium).
Ohio Jour. Sci., xxiii, 247, 1923.
Antea, p. 159.
Alaska, Nevada.
- flavicoxa* Van Duzee, Tr. Am. Ent. Soc., xlvi, 84, 1922. (Xiphandrium). Ga.
Antea, p. 167.
- foliatum* Curran, Antea, p. 150. Ohio.
- fumipenne* Loew, Neue Beitr., viii, 51. (Porphyrops). Middle States.
Loew, Mon. N. Am. Dipt., ii, 146. (Porphyrops).
Antea, p. 147.
- gracile* Curran, Psyche, xxxi, 228, 1924. Mass.
Antea, p. 139.
- grande* Curran, Can. Ent., lv, 210, 1923. (Porphyrops).
Antea, p. 130.
B.C.
- impetuum* Curran, Antea, p. 172. (Rhaphium s.s.).
- insolitum* Curran, Antea, p. 151.
- johnsoni* Van Duzee, Ent. News, xxxiv, 240, 1923. (Porphyrops). N.J., Va., N.H.
Antea, p. 116.
- longicorne* Van Duzee. See coloradense Curr.
- longipalpis* Curran, Antea, p. 148.

- longipes* Loew, Cent. v, 92. (Porphyrops).
 Loew, Mon. N. Am. Dipt., ii, 340.
 O.S. Cat.
 Antea, p. 140.
 N.H., Canada!
- longipes* Wheeler. See *effilatum* Wheeler.
- lugubre* Loew, Neue Beitr., viii, 49. (Rhaphium s.s.).
 Loew, Mon. N. Am. Dipt., ii, 141.
 Ald. Cat. Del. Col.; antea, p. 170.
 Carolina, Pa.
- melampus* Loew, Neue Beitr., viii, 51.
 Lowe, Mon. N. Am. Dipt., ii, 146.
 Smith, Cat.; antea, p. 152.
 Atl. States, N.J.; Quebec.
- montanum* Van Duzee, Proc. Calif. Acad. Sci., x, 47, 1920. (Porphyrops).
 Antea, p. 154.
 Calif.
- nigrum* Van Duzee, Ohio Jour. Sci., xxiii, 245, 1923. (Porphyrops).
 Alaska.
 Antea, p. 101.
- nigricoxa* Loew, Neue Beitr., viii, 51. (Porphyrops).
 Loew, Mon. N. Am. Dipt., ii, 145, 18; antea, p. 144.
 Md.
- nigrociliatum* Curran; antea, p. 99. Colo.
- nigrovittatum* Curran, antea, p. 121.
- nudum* Van Duzee, Pr. U.S.N.M., liii, Art. 21, p. 9, 1924. (Porphyrops).
 1923.
 Antea, p. 105.
- occipitale* Curran, antea, p. 171. (Rhaphium s.s.).
- orientale* Curran, Antea, p. 113. N.B.
- ornatum* Van Duzee, Ent. News, xxxiv, 242, 1923. (Porphyrops). N.Y.
 Curr., Can. Ent., lvi, 138, 1924. (*petchi*).
 Antea, p. 127.
- palpale* Curran, Antea, p. 149.
- petchi* Curran. See *ornatum* Van Duzee.
- pollex* Van Duzee (described as variety of *femoratum* V.D.), Tr. Am.
 Ent. Soc., xlviii, 82, 1922. (Xiphandrium). Nevada.
 Antea, p. 161.
- punctitarsis* Curran, Can. Ent., lvi, 135, 1924. Que.
 Antea, p. 137.
- robustum* Curran, Antea, p. 145.

- rotundiceps* Loew, Neue Beitr., viii, 51, 18. (Porphyrops).
 Loew, Mon. N. Am. Dipt., ii, 146.
 D.C.
 Antea, p. 128.
- shannoni* Curran, Antea, p. 155.
- signifer* O.S., Cat., 242. (Porphyrops). N.Y.
 Antea, p. 141.
- simplicipes* Curran, Antea, p. 169.
- slossonae* Johnson, Psyche, xiii, 59, 1906. (Leucostola).
 Van Duzee, Ent. News, xxxiv, 239, 1923.
 N.H.
 Antea, p. 131.
- spinatarsis* Curran, Can. Ent., lvi, 139, 1924.
 Antea, p. 115.
 Man., Colo.
- subarmatum* Curran, Psyche, xxxi, 229, 1924.
 Antea, p. 124.
 N.B., N.H.
- temerarium* Becker, Abh. Zool.-Bot. Ges. in Wien, xiii, 150, 1921. (Xiphandrium). Colo.
 Antea, p. 157.
- terminale* Van Duzee, Pro. U.S.N.M., lxiii, Art. 21, p. 7, 1924. (Porphyrops). Alaska.
 Antea, p. 107.
- triangulatum* Van Duzee, Tr. Am. Ent. Soc., xlviii, 83, 1922. (Xiphandrium). Arizona.
 Antea, p. 158.
- tricaudatum* Van Duzee, Ohio Jour. Sci., xxiii, 243, 1923. (Porphyrops). Alaska.
 Antea, p. 134.
- vanduzeei* Curran, Antea, p. 104. Indiana.
- xipheres* Wheeler, Proc. Calif. Acad. Sci., ii, 34. Pa.
 Van Duzee, Tr. Am. Ent. Soc., xlviii, 81, 1922. (Xiphandrium).
 Antea, p. 162.

EXPLANATION OF FIGURES

1. *Rhaphium nigrociliatum* n.sp. Outer genital lamella of ♂.
2. " " ♂ antenna.
3. " " ♀ antenna.
4. " *vanduseei* n.sp. Outer genital lamella of ♂.
5. " " ♂ antenna.
6. " *nudum* V.D. Genitalia of ♂.
7. " " ♂ antenna.
8. " *terminale* V.D. Genitalia of ♂ (Redrawn after Van Duzee).
9. " " ♂ antenna (id.).
10. *Rhaphium banksi* V.D. n.sp. Outer genital lamella of ♂.
11. " " ♂ antenna.
12. " *albibarba* V.D. Genitalia of ♂ (Redrawn after Van Duzee).
13. " " ♂ antenna (id.).
14. " *armatum* Curran. Genitalia of ♂.
15. " " ♂ antenna.
16. " *orientale* n.sp. Genitalia of ♂.
17. " " ♂ antenna.
18. " *spinatarsis* Curran. Middle tarsus of ♂.
- 18a. " " Outer genital lamella of ♂.
19. " *caudatum* V.D. n.sp. Genitalia of ♂.
20. " " ♂ antenna.
21. " *discolor* Zett. Genitalia of ♂ (Redrawn after Becker).
22. " *brevilamellatum* V.D. n.sp. Genitalia of ♂.
23. " " ♂ antenna.
24. " *nigrovittatum* n.sp. Genitalia of ♂.
25. " *campestre* Curran. Wing.
26. " " ♂ antenna.
27. " *subarmatum* Curran. Genitalia of ♂.
28. " *crassipes* Meig. Genital lamella of ♂.
29. " " Middle tarsus of ♂.
30. " " ♂ antenna.
31. " " Wing of ♀.
32. " *ornatum* V.D. ♂ antenna.
33. " " ♂ fore tarsus.
- 33a. " " ♂ genitalia.
34. " *rotundiceps* Loew. Genital lamella of ♂.
35. " " ♂ antenna.
36. " " Fore tarsus.
37. " *grande* Curran. Genitalia of ♂.
38. " " ♂ antenna.
39. " *slossonae* Johns. Genitalia of ♂.
40. " *elegantulum* Mg. Genitalia of ♂ (redrawn after Becker).
41. " *canadense* Curran. Genital lamella of ♂.
42. " " ♂ antenna.
43. " *punctatarsis* Curran. Outer genital lamella of ♂.
44. " " Middle tarsus of ♂.

45. *Rhaphium gracile* Curran. Outer genital lamella of ♂.
46. " " ♂ antenna.
47. " " ♀ antenna.
48. " *signifer* O.S. Genitalia of ♂.
49. " " ♂ antenna.
50. " *effilatum* Wh. Genitalia of ♂.
51. " " ♂ antenna.
52. " *robustum*. Genital lamella of ♂.
53. " " ♂ antenna.
54. " *fascipes* Mg. Genital lamella of ♂.
55. " " ♂ antenna.
56. " " ♂ posterior tibia.
57. " *longipalpis* n.sp. Genitalia of ♂.
58. " " ♂ antenna.
59. " *longipalpis* n.sp. ♀ antenna.
60. " " ♂ palpus.
61. " *palpale* n.sp. Outer genital lamella of ♂.
62. " " ♂ antenna.
63. " *nigricoxa* Loew. ♀ antenna.
64. " *insolitum* n.sp. Genitalia of ♂. (A. Outer lamella, B. Auxiliary lobe).
65. " " ♂ antenna.
66. " *melampus* Lw. Genitalia of ♂.
67. " " ♂ antenna.
68. " *shannoni* n.sp. Genitalia of ♂.
69. " " ♂ antenna.
70. " *atkinsoni* n.sp. Genitalia of ♂.
71. " " ♂ antenna.
72. " " ♀ antenna.
73. " *temerarium* Becker. Genitalia of ♂.
74. " " ♂ antenna.
75. " " ♀ antenna.
76. " *triangulatum* V.D. Outer genital lamella of ♂.
77. " *femoratum* V.D. Genitalia of ♂.
78. " " ♂ antenna.
79. " *pollex* V.D. Inner genital lamella of ♂. (Redrawn after Van Duzee).
80. " *xiphères* Wheeler. ♂ antenna (redrawn after Wheeler).
81. " *coloradense* Curran. Genitalia of ♂ (redrawn after Van Duzee).
82. " *aldrichi* V.D. Outer branch of outer genital lamella of ♂ (redrawn after Van Duzee).
83. " *aldrichi* V.D. Inner branch of outer genital lamella of ♂ (id.).
84. " *exile* n.sp. Outer genital lamella of ♂.
85. " " ♂ antenna.
86. " *arboreum* Curran. Genitalia of ♂.
87. " *simplicipes* n.sp. Genitalia of ♂.
88. " " ♂ antenna.
89. " *impetuum* n.sp. Outer genital lamella of ♂.
90. " " ♂ antenna.
91. " " ♀ antenna.

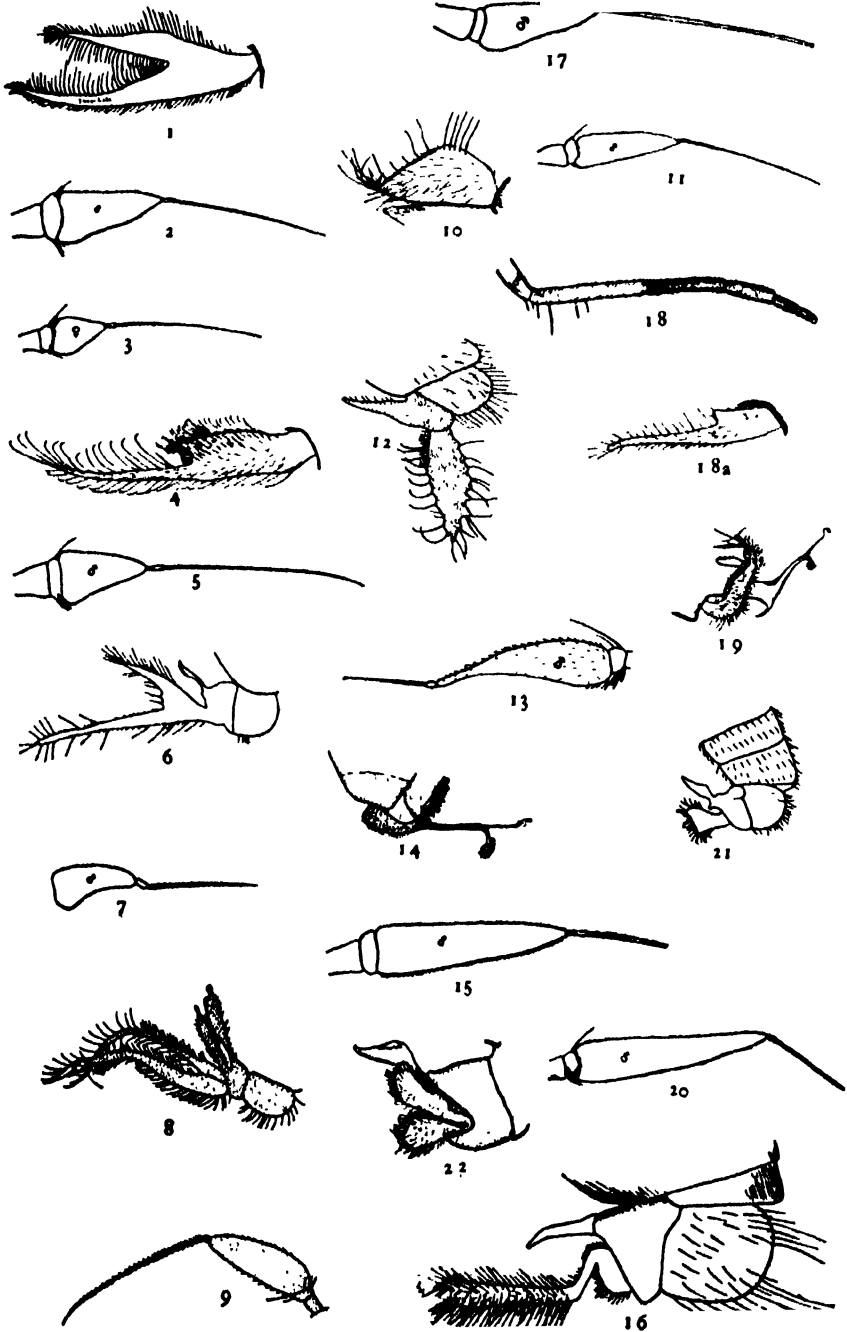

CURRAN ON THE GENUS RHAPHIUM

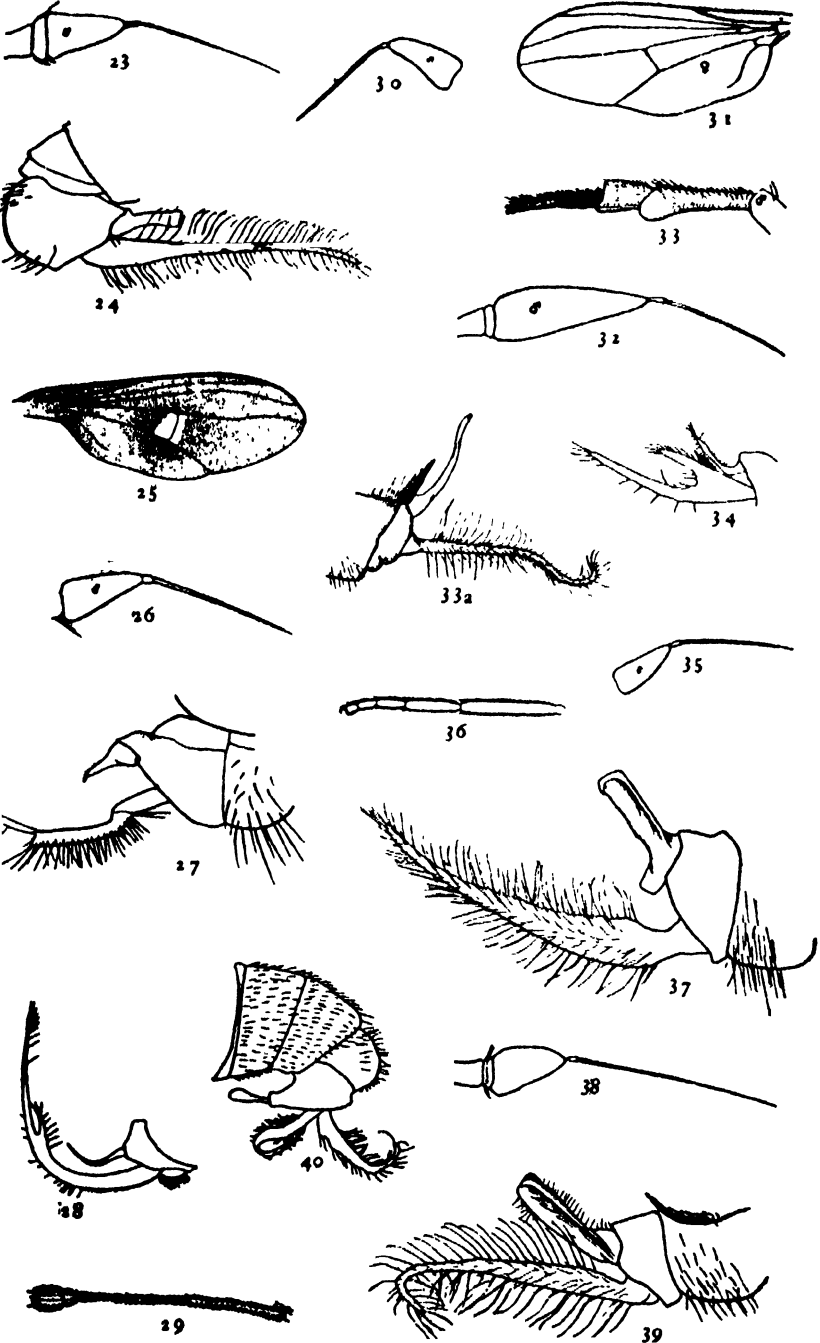

CURRAN ON THE GENUS RHAPHIUM

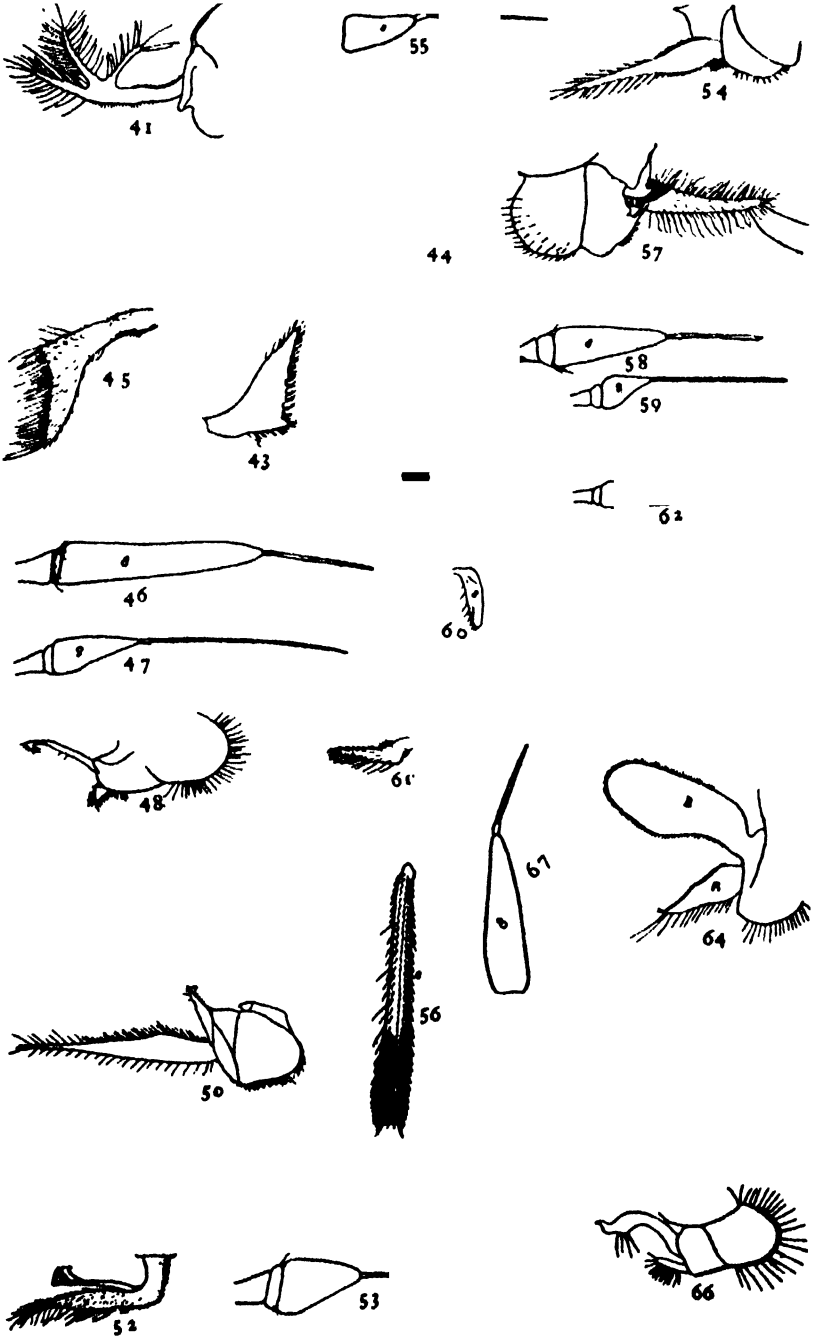

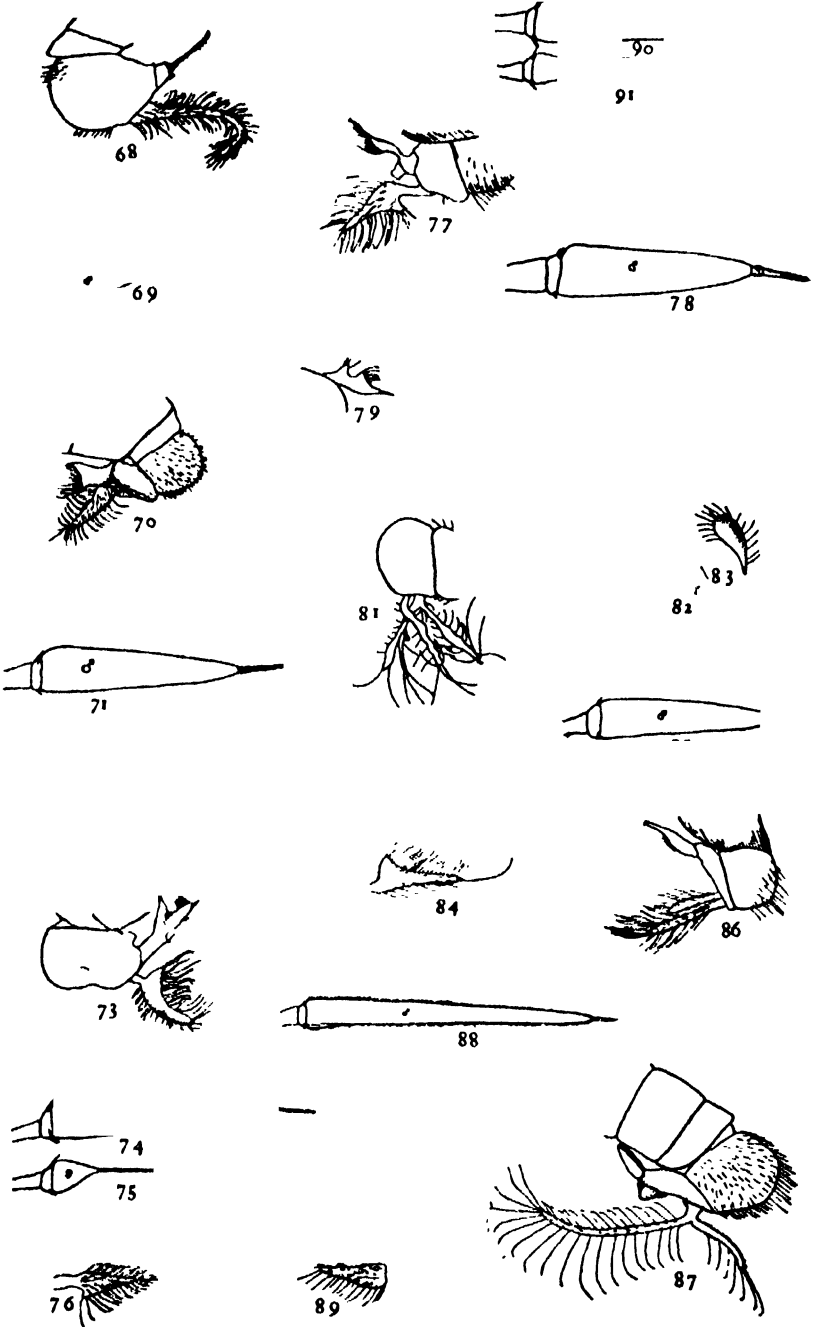

CURRAN OF THE GENUS RHAPSIMUM

TRANSACTIONS

OF THE

Royal Canadian Institute

No. 36

JULY, 1928.

VOL. XVI, PART 2

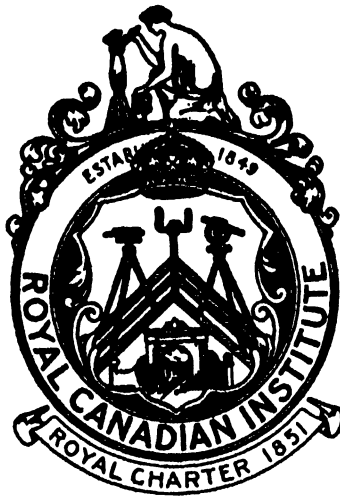

28754 / 36

THE MUSCULATURE OF PANDALUS DANAE STIMPSON

By ALFREDA A. BERKELEY

INTRODUCTION

Considering the quantity of work that has been done on the external anatomy and taxonomy of Crustacea, there is an extraordinary paucity of literature dealing with the internal morphology, and this is especially true of the muscles. As far back as 1818 W. L. Suckow published a description of crayfish muscles, and since his time Milne-Edwards (1834), Lemoine (1868), Mocquard (1883) and Huxley (1879) have all dealt in some measure with the subject. The work of the early investigators was all fairly general, however, and was verified or corrected by Walter Schmidt in 1915 when he published his paper "Die Muskulatur von *Astacus fluviatilis* (*Potamobius astacus* L.)."

The order Decapoda includes two sub-orders Natantia and Repantia. The former contains more or less free-swimming forms, and to it belongs the prawn, *Pandalus*. To the latter belong the creeping forms, including crayfish and lobsters, as well as crabs and hermit crabs. The species of *Pandalus* chosen for the present study was *P. danae* Stimpson, the commonest form of edible prawn found in the neighbourhood of Vancouver Island, B.C. Comparisons were also made from time to time with the three other species of *Pandalus* used commercially near Vancouver, namely *P. hypsinotus* Brandt, *P. borealis* Krøyer, and *P. platyceros* Brandt. However, differences in musculature were found to be practically negligible. Where reference is made to the crayfish, *Astacus*, the species meant is that which is now more generally known as *Potamobius astacus* L.

Crayfish and lobsters are somewhat alike in their general habits and are similarly adapted to a life upon the bottom. The thoracic legs or pereiopods are strong and adapted for walking and supporting the body, while swimming is performed mainly by flexions of the abdomen with its large tail fin. This latter mode of locomotion is employed as a measure of protection in dashing backward into shelter. *Pandalus*, on the other hand is a free-swimming form, and, as such, is possessed of better developed abdominal appendages, or pleopods, while the pereiopods are very slender and directed forwards. Only the three posterior pairs of pereiopods are used for walking and these to a limited extent.

In these respects *Pandalus*, like most of the prawns, resembles the more primitive pelagic Euphausiacea and Mysidacea.

Pandalus differs further from the crayfish and lobster in lacking the principal chelipeds developed in the latter forms from the first pair of pereopods; in fact this pair of appendages in *Pandalus* is exceptionally slender and weak and bears only the vestige of a claw. The second pereopods are extremely long, the left one being much longer than the right. They are many-jointed and are usually carried folded in half. None of the other pereopods are chelate, each terminating in a single claw. It should also be noted that in *Pandalus* all the thoracic appendages, except the last pereopod, bear an epipodite, or a modified form of epipodite called a mastigobranchia. In the crayfish and lobster the only appendage which bears this epipodite is the first maxilliped. The remaining appendages of the cephalothorax resemble those of the crayfish fairly closely, except the third pair of maxillipeds which is remarkably different. It lacks the exopodite, and the endopodite is long, slender, and leg-like, although it differs from the pereopods in having fewer joints and lacking a terminal claw. The whole appendage is very thickly covered with setae, which would seem to indicate that it is mainly used in some sensory capacity.

The main difference between the abdominal appendages of *Pandalus* and those of *Astacus* lies in the first two pairs of pleopods of the male. Whereas in *Astacus* these are much altered in connection with their function as sperm depositors, in *Pandalus* they are hardly modified at all.

Taking into consideration these differences in the structure of the appendages, it has seemed worth while to consider the muscles of *Pandalus* in some detail.

The following investigation is largely based on Schmidt's work, and has been made considerably simpler by the use of his descriptions. The general arrangement of his subject matter has been followed and his terminology retained except where change seemed necessary. In the comparisons made between *Pandalus* and *Astacus*, the writer has in general depended upon Schmidt's account of the latter, although in connection with certain features dissections of an American crayfish (*Cambarus propinquus* Girard) were carried out.

It was at the suggestion of Dr. E. M. Walker that this work was undertaken, and thanks are due to him and to Dr. B. A. Bensley for their interest and assistance. They are also due to the University of Toronto for financial aid in the form of fellowships, and for providing all necessary laboratory facilities.

TECHNIQUE

The muscles of these shrimps are firm and preserve well. A few

specimens were preserved in 70 per cent. alcohol, and a few in 10 per cent. formalin, but this tended to make the carapace too brittle, especially the formalin, and so increased the difficulty of dissection. The majority of the material was preserved in a mixture made up as follows:

- Formalin 10% 1 part.
- Alcohol 70% 1 part.
- Glycerine 1 or 2 parts.

MUSCULATURE

Schmidt divides the muscles as a whole into two large groups, the body muscles and those of the appendages. The former class includes those which unite thorax with abdomen or segment with segment, or they may even pass from one part of a segment to another, in which case they serve to strengthen rather than to move. It will be convenient similarly to divide the muscles of *Pandalus danae* into two groups.

Part I. THE MUSCULATURE OF THE HEAD AND THORAX

A. *The Muscles of the Body*

1. Longitudinal Muscles

The longitudinal body muscles are somewhat complicated in general appearance because of their tendency to be much branched and to twist about one another. Thus the lateral muscles arise dorsally and are inserted laterally, while the dorsal muscles arise laterally and pass under the lateral muscles to their insertion on the dorsal surface. Where the muscles are branched, even if attached to the tergal surface, there is a tendency for these branches to arise in different segments, thus suggesting traces of segmentation. The superficial ventral muscles, however, are the only ones that show true segmentation.

In *Astacus*, the body muscles are much simpler. They are less branched, weaker, tending to a ribbon rather than a cord-like form, and show little trace of segmentation in their origin. As the epimeral plate is larger, the only muscle having an origin on the carapace is the median branch of the lateral muscle. There are two small muscles in *Astacus* which I was unable to find in *Pandalus*. These are the *contractor epimeralis*, which arises in the dorsal part of the epimeral plate and runs from the fourth to the fifth thoracic segments, and the superficial dorsal muscle connecting thorax and abdomen laterally.

(a) Ventral Muscles

The ventral muscles show a division into two layers. One of these is very simple, weak and flat, the other is much stronger, more com-

plicated and less superficial. Both layers tend to show traces of segmentation more than do the dorsal muscles, but this is especially true of the weak superficial layer. A consideration of the mobility of the sternal surface of the thorax compared with the immovable tergal surface will show that this difference in segmentation of the muscles is only to be expected.

Musculi ventrales superficiales thoracis (vsth, [2:3, 3:4, 4:5, 5:6, 6:7, 7:8], Fig. 2, 5)

These muscles run from segment to segment on each side of the nerve cord, being attached to the paraphragms of the endophragmal system in each segment. Each muscle joins the caudal edge of the paraphragm of one segment to the rostral edge of the paraphragm in the segment following. The anterior three of the series (vsth 2:3, 3:4 and 4:5, Fig. 2, 5) are very weak, but posterior to the fifth segment they become more distinct. The fourth and fifth muscles (vsth 5:6, 6:7, Fig. 2, 5) are about equal in size. The seventh muscle (vsth 7:8, Fig. 2, 5) is a little stronger. It runs from the paraphragm of the seventh segment to the beak-like process on the last thoracic segment and is continued as a thin tendinous ribbon to its insertion on the caudal edge of this last segment, just where the superficial ventral thoraco-abdominal muscle has its origin. The whole series obviously pulls the various thoracic segments together.

(In *Astacus* the paraphragms are extended into mesophragms which unite over the nerve cord, and the superficial ventral muscles are attached to these mesophragms. Thus the two muscles of a pair lie side by side in several of the segments instead of on each side of the nerve cord.)

Musculus ventralis superficialis thoraco-abdominalis (vstha, Fig. 5)

This muscle runs from the thorax to the abdomen, and is really a continuation of the ventral superficial thoracic muscle. It is a ribbon of muscle fibres attached on one side to the caudal edge of the last thoracic segment, and on the other to the rostral edge of the first abdominal segment. It helps to pull the abdomen towards the thorax.

(In *Astacus* this muscle is much longer and stronger and has two distinct branches.)

Musculus ventralis capitis (vc, Fig. 9)

This is a thin tendinous ribbon which springs from the anterior fascia in front of the head apodemes, passes over the mandible and is inserted with a few short muscle fibres at the lateral posterior end of the epistoma. Its use is not very apparent, but it probably only helps to strengthen the anterior fascia.

Musculi thoracales anteriores (tha, Fig. 1, 2, 4)

This is the largest and strongest of the body muscles. It is continued in the abdomen as a big and complicated mass of muscle fibres, while in the thorax it occupies a very great part of the space left by the viscera. Undoubtedly its action is to flex the abdomen and its great development is due to the use of the abdomen in swimming. The main lateral part of the muscle (tha l, Fig. 1 and 4) arises on the carapace anterior to the head apodeme by a very broad semi-circular surface. The smaller median portion (tha m, Fig. 2, 4) arises partly on the paraphragm of the first thoracic segment and partly on the anterior fascia where it covers this paraphragm. It almost immediately joins the lateral part. Two very tiny branches (tha m₁, tha m₂, Fig. 2) arise by tendons on the paraphragms of the second and third segments respectively and pass directly to join the median branch. The main lateral slip also has two side branches (tha₃, tha₄, Fig. 1, 4) which are attached to the epimeral plate of the fourth and fifth thoracic segments. The origins of these two small branches are closely connected with the origins of the two branches of the dorsal thoraco-abdominal muscle which arise in the fourth and fifth segments. All these parts unite to form a dense mass of muscle which is eventually inserted in the abdomen.

(In *Astacus* this muscle is very much weaker, the branching is slightly different and much more distinct, and the main lateral portion arises on the epimeral plate of the first thoracic segment.)

(b) Dorsal Muscles

These muscles show absolutely no trace of segmentation, except in the origin of various branches. They serve wholly to move the abdomen instead of serving to some extent to bring together the thoracic segments as do the ventral muscles.

Musculi dorsales thoraco-abdominales (dth [m and l], Fig. 1, 2, 3)

As indicated above, this muscle, which is fairly large, shows traces of segmentation in its origin. It may be divided into two main parts (dthm and dthl, Fig. 1, 2, 3). The inner part (dthm, Fig. 1, 2, 3) is the more substantial and has its origin as a flat, fan-shaped area on the carapace about the second thoracic segment, just posterior to the origin of the anterior thoracic muscle (tha, Fig. 1). It has two distinct cord-like parts, one of which tends to split again. These parts twist about one another like a rope, but all have their origin at the same place and are inserted together. The outer portion (dthl, Fig. 1, 2, 3) has its origin in a series of branches arising on the epimeral plate at the third, fourth, fifth, and sixth thoracic segments. Those which have their

origin on the third, fourth and fifth segments tend to twist about one another like those of the median portion, but that which has its origin at the sixth segment is separate from the others until its insertion and has itself a tendency to divide into three twisted branches. All these various parts are inserted close together on the dorso-medial edge of the first abdominal segment, in such a way that they appear to be directly continuous with the abdominal muscles. The whole system of muscles extends the abdomen but is not nearly as strong as its opponent, the ventral system.

(c) Lateral Muscles

Like the dorsal muscles, these serve only to move the abdomen, since they are connected with the immovable tergal part of the thorax.

Musculi laterales thoraco-abdominales (lth [m and l], Fig. 1, 2, 3)

Just as the anterior thoracic muscle and the dorsal muscle are both divided into two main parts, so this lateral muscle has two branches of which the median one (lthm, Fig. 1, 2, 3) is far the larger and stronger. On dissecting the animal from the dorsal side the median branch more or less covers all the other body muscles in the thorax. It is a ribbon of muscle fibres having its origin dorsally on the carapace just posterior to the place where the head and thorax probably unite, and close to the mid-line. It is inserted just at the point of union of the caudal end of the epimeral plate and the first abdominal segment. The lateral branch is again divided into two parts (lth₁ and lth₂, Fig. 1), one having its origin on the epimeral plate, the other on the paraphragm of the last segment. The first of these (lth₁, Fig. 1) has three parts which arise separately but very close together in the neighbourhood of the sixth and seventh thoracic segments, and unite almost immediately. The second branch (lth₂, Fig. 1) is longer and more slender than the first. It arises on the beak-like continuation of the last thoracic segment and shows a tendency to split into two parts, one much weaker than the other. Both parts of the lateral branch unite with the median branch just in front of the point of insertion. The whole lateral muscle assists the anterior thoracic muscle in its action or, by contracting on one side only, it may pull the abdomen sideways.

2. Transverse Muscles and Supporting Fascias

These muscles are very weak in comparison with those which join segment to segment or thorax to abdomen, and they serve rather for support than for contraction. There is a notable tendency for tendons to collect into definite sheets or fascias. It has been impossible to show

these clearly in any of the figures, except a little in Fig. 9, but it is advisable to describe the principal ones, especially as two are more or less represented in *Astacus* by muscle fibres.

Musculus attractor epimeralis (attr ep, Fig. 5)

This is a short, broad ribbon of fibres starting at the first thoracic segment at the apex of the triangle formed by the epimeral plate and extending to the fifth segment. It joins the epimeral plate and the carapace, thus connecting endoskeleton and exoskeleton.

(In *Astacus* this ribbon extends from the posterior end of the carapace to the anterior where it ends on the cervical groove level with the head apodemes, being joined, as in *Pandalus*, on one side to the dorsal edge of the epimeral plate and on the other to the carapace.)

Musculi dorso-ventrales anteriores (dva₁ and dva₂, Fig. 1, 2, 9)

There are two of these muscles which both spring laterally from the dorsal side of the head apodemes and are inserted near the posterior mandibular muscle (add p mand, Fig. 1, 2, 9). The first of these (dva₁, Fig. 1, 2, 9) is practically a fan-shaped tendon with a few muscle fibres at each end. It is indirectly attached to the head apodeme, having its origin in a little cluster of muscle fibres on the dorso-lateral edge of the anterior fascia (fa, Fig. 9), and then spreads out to cover about a third of the depressor of the second antenna (depr c II Ant, Fig. 1, 2) and be inserted on the carapace almost without muscle fibres. The other muscle (dva₂, Fig. 1, 2, 9) has its origin partly on the head apodeme and partly on the anterior fascia just posterior to the origin of the first anterior dorso-ventral muscle. It passes dorsally as a long thin tendon to be inserted on the carapace near the posterior end of the insertion of the first anterior dorso-ventral muscle by a cluster of short muscle fibres. These muscles probably serve partly to support the anterior fascia and may also protect the viscera which would otherwise be compressed by the contraction of the antennal muscles.

(Only the second anterior dorsoventral muscle occurs in *Astacus*.)

Musculus dorso-ventralis posterior (dvp, Fig. 5)

The posterior dorso-ventral muscle is a short moderately stout muscle, lying at the lateral side of the head apodeme. It has its origin partly on the head apodeme and partly on that part of the anterior fascia which covers over the apodeme. It spreads out slightly towards its insertion on the carapace on a level with the head apodeme. Its use is obscure, but it probably aids in some way in support.

Anterior fascia (fa, Fig. 9)

The anterior fascia lies partly in front of and slightly under, and partly on top of the head apodemes. That part which lies in front of the apodeme is a dense tendinous mass and serves indirectly to attach the muscles of the mandible, and first maxilla and the anterior dorso-ventral muscles to the apodemes. The remainder covers the head apodemes completely and extends back to the second thoracic segment. There is a small opening in the centre just above the posterior part of the head apodemes. At the sides it passes between the muscles of the appendages and is attached to the epimeral plate. Here it serves for the attachment of the posterior dorso-ventral muscle and the median part of the anterior thoracic muscle. The whole anterior fascia is only loosely attached to the head apodemes.

(In *Astacus* this fascia is represented by two groups of muscle fibres which Schmidt calls the compressors of the endophragm. These muscles unite the mesophragms of the head apodemes of the first and second thoracic segments, but they have practically no power of contraction.)

Posterior fascia

Just anterior to the last thoracic segment there is a peculiar little cross of fibrous material. The two dorsal extremities of this cross are attached to the paraphragms of the seventh segment while the ventral extremities are attached to the endosternites of the same segment. Covering the last thoracic segment there is a thin sheet of tendon. This has four arms, two of which go forward to be attached partly to the epimeral plate in this region, while the other two pass back to a place of attachment in the posterior part of the last thoracic segment. The nerve cord rests on this posterior fascia but otherwise its use is obscure.

B. The Muscles of the Appendages

Before dealing with the muscles of the appendages in detail, it may not be amiss to review briefly the general structure of a Crustacean appendage and to indicate the terminology which will be followed. This terminology is essentially that used by Schmidt, and, although the names of the muscles do not always quite correctly denote their use, they have been retained wherever at all possible for the sake of more clearly showing homologies.

The typical appendage in *Pandalus* has a base or protopodite which usually consists of two joints, the coxopodite and basipodite. On this two branches, the endopodite and exopodite, and frequently a third structure, the epipodite, are fixed. The exopodite shows a tendency

to disappear and does not occur at all in the walking legs or pereopods. The endopodite, on the other hand, becomes more specialized and in the pereopods consists, typically, of five joints, the ischiopodite, meropodite, carpopodite, propodite and dactylopodite. The first antennae, eyes and mandibles are exceptions to all general rules, but special variations in the other appendages will be dealt with in the detailed description.

The coxopodite is usually articulated with the body in such a way that it rotates about an axis which is perpendicular or somewhat inclined to the sagittal plane. The basipodite is articulated with the coxopodite so that it rotates about an axis perpendicular to that of the coxopodite. Thus the articulations of coxopodite and basipodite together have the effect of a ball and socket joint. Now, the muscles of the protopodite differ from those of the rest of the appendage in that they connect it with the body and therefore have been given a special nomenclature. Those which move the coxopodite are called the promotor and remotor and those which move the basipodite are the depressor and levator.

In general the joints of the endopodite are articulated similarly to those of the protopodite so that one joint rotates about an axis perpendicular to the axis of rotation of the joint preceding. Where this is the case the muscles corresponding in action to those of the coxopodite are called the protractor and retractor, and those corresponding to the muscles of the basipodite are the adductor and abductor. Other special names that are given where necessary will be explained as they occur.

The Eye (Fig. 6)

The soft chitinous ring which connects the two eyes is very long, so that the eyes themselves are set far apart on the head. Huxley considers this middle ring as representing the sternal portion of the ophthalmic somite, but Schmidt suggests that it is probably composed of the two basal segments of the eyes fused together and this theory is certainly supported by the musculature. The second segment is very small and the optic cup large in proportion so that the latter can rotate easily about the former, and the muscles are developed accordingly.

Musculus oculi basalis anterior (oba, Fig. 6)

This muscle arises medially on the epistoma just behind the oesophagus between the coxal joints of the second antennae, having its origin in a short unpaired tendon. This tendon soon becomes paired and changes to two long ribbons of muscle fibres which pass dorsally and slightly forward to be inserted side by side dorso-medially on the proximal edge of the soft chitinous ring, uniting the optic peduncles. This paired

musculature supports Schmidt's suggestion, referred to above, that the middle ring represents the fused basal segments. As the ring is quite supple the muscles, attached medially, bend it inwards, thus approximating the solid joints attached to it. As the second segment is small there is little room for the adductor muscle and consequently most of the work of approximating the eyes is done by the anterior basal muscle and the attractor.

Musculus oculi basalis posterior (obp, Fig. 6)

This muscle has its origin in the same unpaired tendon as the anterior basal muscle. It remains unpaired for about two-thirds of its length and then becomes paired, the two parts diverging fairly rapidly towards their insertion on the tergal surface of the carapace. Here they are attached by two clusters of muscle fibres immediately above the point of origin. The use of this muscle is obscure. It occurs in practically the same form in *Astacus*, and Schmidt suggests that it protects the supra-oesophageal ganglion by drawing the anterior basal muscle back and so keeping it from pressing on the ganglion. It also appears, in *Pandalus*, to act as a support for the oesophageal ganglion and the nerves connected therewith.

Musculus oculi attractor (attr, Fig. 6)

The attractor is a fairly strong ribbon of muscle fibres arising on the ventral side of the middle cylinder near its junction with the second joint. Passing obliquely dorsally the two muscles of the pair are inserted close together medially on the dorsal surface of the middle ring. Inasmuch as it passes slightly obliquely from the anterior ventral surface of the eye stalk to its posterior dorsal surface as well as from the lateral side to the middle line, this muscle opposes the rotating action of the basal muscles. Further, since the second segment is somewhat soft and flexible as well as the middle ring, these two muscles are enabled to act as adductors. Probably the second use is the chief one.

(In *Astacus* the attractor is inserted on the dorso-distal side of the second segment, and opposes the basal muscles, but is only weakly developed.)

Musculus oculi adductor (add, Fig. 6)

This is a weak and comparatively unimportant muscle. It runs from the dorso-distal edge of the second segment to the edge of the optic cup. Probably it is too small to have much effect in the rotation of the optic cup, and merely serves as a brake on the action of the abductor muscle.

Musculus oculi abductor (abd, Fig. 6)

The abductor arises by a short ligament on the dorso-distal edge of the second segment and is inserted on the proximal edge of the optic cup near the corneal surface. It moves the eye away from the mid-line and somewhat rotates it, thus acting as an antagonist to the combined actions of the adductor, the attractor and the basal muscles.

Musculi oculi retractores

There are four of these retractors all having their origin on the supple membrane between the second segment and the optic cup and all inserted close to the corneal surface on the sides of the optic cup. They approximate the cup to the second segment or rotate it on the base.

Musculus oculi retractor dorsalis (rd, Fig. 6)

Arises on the dorsal side of the supple membrane referred to above and runs obliquely to its insertion on the dorso-distal sides of the optic cup. As well as acting as a retractor this muscle is also a rotator, opposing the movement of the medial retractor in this respect.

Musculus oculi retractor ventralis (rv, Fig. 6)

This muscle lies opposite the dorsal retractor, but its fibres run perfectly straight from the ventral side of the supple membrane to the ventral side of the optic cup near the corneal surface. Thus it can only act as a retractor.

Musculus oculi retractor lateralis (rl, Fig. 6)

The lateral retractor is somewhat shorter than the others but probably about equal in strength. It arises laterally on the supple membrane and passes as a broad muscular ribbon to its insertion on the proximal side of the optic cup.

(In *Astacus* this muscle has two branches.)

Musculus oculi retractor medialis (rm, Fig. 6)

This muscle arises on the distal side of the supple membrane and passes obliquely to its insertion on the optic cup by the side of the dorsal retractor. Its action is probably more that of a rotator, thus opposing the action of the dorsal retractor, than of a retractor.

(In *Astacus* this muscle is very weak.)

The First Antenna (Fig. 7)

The first antenna varies somewhat from the other appendages in

that it is, on the whole, more flexible and it has no strictly biramous character. Huxley is one of the few writers that consider the two flagella as representing the exopodite and endopodite, and his views are not supported by the muscles. The first segment is rotated about an axis perpendicular to the sagittal plane, so that the muscles that move it can rightly be called the promotor and remotor. The other joints, however, do not fit into the general plan and cannot be considered as representing a changed basipodite.

Musculus promotor I antennae (prom, Fig. 7)

This muscle has its origin at the lateral corner of the three cornered aperture which unites the interior of the body with the interior of the first antenna. It is attached by a very short tendon dorso-laterally on the proximal edge of the first joint. It moves the first antenna in the sagittal plane.

Musculus remotor a I antennae (rem a, Fig. 7)

This remotor has its origin in a very short tendon on the ventral side of the proximal edge of the first joint near the middle line. It spreads out to be attached by a broad surface to the middle of the ventral side of the same joint. It acts as an antagonist to the promotor.

Musculus remotor b I antennae (rem b, Fig. 7)

This muscle arises by the side of remotor *a* and is inserted on the ventral side of the first joint medially to remotor *a*. It is much weaker than remotor *a*; which it assists in function.

Musculus productor₂ I antennae (prod₂, Fig. 7)

This muscle arises laterally in the distal half of the first joint by a fairly broad surface, and is inserted on the proximal edge of the second joint without a tendon. It moves the second joint dorsally in the sagittal plane.

Musculus reductor₂ I antennae (red₂, Fig. 7)

It arises medially in the middle of the first joint, on the ventral side of the adductor muscle and close to its origin. It is inserted ventro-medially on the proximal edge of the second joint, and opposes productor₂ in its function.

Musculus productor₃ I antennae (prod₃, Fig. 7)

Arises medially in the proximal part of the second joint and is inserted by a short tendon dorso-laterally on the proximal edge of the third joint. It moves the third segment dorsally in the sagittal plane.

Musculus reductor₃ I antennae (red₃, Fig. 7)

Arises without a tendon on the dorso-medial side of the second joint and is attached medially by a short tendon to the proximal edge of the third segment. It opposes productor₃ in its function and approximately equals it in strength.

Musculus abductor₃ I antennae (abd₃, Fig. 7)

Arises ventrally in the proximal half of the second joint and is inserted ventro-laterally on the proximal edge of the third joint. It moves the latter horizontally away from the median plane and helps to oppose the action of the adductor muscle. The third segment has only one point of articulation so that it can be moved in four directions and somewhat rotated.

Musculus reductor₄ I antennae (red₄, Fig. 7)

Arises medially on the proximal edge of the third joint. It has two distinct branches which are inserted one at each side of the proximal edge of the first joint of the olfactory flagellum. It moves the flagellum ventrally or, by contracting one branch at a time, can move it laterally or rotate it somewhat. There are no special muscles within the flagella.

Musculus adductor I antennae (add, Fig. 7)

This muscle arises by a broad surface on the medial side of the first segment, proximal and dorsal to the origin of reductor₃. It runs up the ventral side of the antenna to be inserted ventrally about the middle of the third joint by a very short tendon. A branch is given off in the second segment which is inserted medially by a short tendon on the proximal edge of the third segment. It moves the whole antenna, especially the third joint and the olfactory flagellum, medially in the horizontal plane.

(Schmidt does not mention this muscle as occurring in *Astacus*.)

Musculus abductor a I antennae (abd a, Fig. 7)

Arises, without a tendon, dorso-laterally on the proximal edge of the first segment. It spreads out a little and then narrows to be inserted without a tendon on the ventral side of the first segment just where the lateral expansion joins the main body of the segment. It opposes the adductor muscle in its action.

Musculus abductor b I antennae (abd b, Fig. 7)

This muscle has the same origin as abductor *a*, which it assists in

its action, but is a much shorter muscle with fewer fibres and is inserted on the dorsal side of the first segment.

(Neither abductor *a* nor abductor *b* are mentioned in Schmidt's account of *Astacus*.)

The Second Antennae (Fig. 8)

Of all the head appendages the second antenna has the greatest number of joints, and consequently the greatest degree of mobility. The whole antenna is very large with a big basipodite and a broad well-developed squame, hence the extra size of the muscles that move these.

Schmidt considers the first segment of this antenna in *Astacus* as representing the united ischiopodite and meropodite, and it does appear to be divided. No such division is visible in *Pandalus* and the muscles which move this segment are reduced to one pair of antagonists. It was obvious, however, that the muscles hereafter called *musculus meropoditis* and *musculus ischiopoditis* are homologous with the muscles so named in *Astacus*. I have, therefore, retained these names for the present, and considered the ischiopodite and meropodite as being completely fused. The flagellum probably represents the dactylopodite.

Musculus promotor II antennae (prom, Fig. 8; prom II Ant, Fig. 1)

Arises by a broad surface on the dorsal carapace of the head just ventral to the base of the eyes and is inserted by a short strong tendon laterally on the proximal edge of the coxopodite. It moves the coxopodite forward or raises it.

Musculus remotor II antennae (rem, Fig. 8; rem II Ant, Fig. 1)

This muscle is much stronger than its antagonist, the promotor. It arises on the dorsal carapace just in front of the origin of the lateral branch of the anterior thoracic muscle. It passes ventrally to be inserted without a tendon on the ventral side of the proximal edge of the coxopodite. It not only acts as an antagonist to the promotor, but also somewhat as an abductor, thus opposing depressor *b*.

Musculus levator II antennae (lev, Fig. 8)

This muscle arises on the lateral side of the coxopodite and passes horizontally to the mid-ventral side of the proximal edge of the basipodite. It is a short, thick, strong ribbon of muscle fibres. It moves the basipodite outwards. It is peculiar in that it arises within the appendage.

Musculi depressores II antennae

In *Pandalus* there are only three depressors although there are four in *Astacus*. As the basipodite is easily movable they rotate it.

Musculus depressor a II antennae (depr a, Fig. 8)

This is a strong compact muscle situated entirely in the median part of the coxopodite. It arises ventro-medially in the proximal part of the coxopodite and is inserted ventro-medially on the proximal edge of the basipodite. It moves the basipodite towards the mid-line.

Musculus depressor b II antennae (depr b, Fig. 8)

Arises on the anterior end of the epistoma and is inserted ventro-medially on the proximal edge of the basipodite near the insertion of depressor *a*. Besides assisting the other depressors it somewhat opposes the remotor.

Musculus depressor c II antennae (depr c, Fig. 8; depr c II Ant, Fig. 1, 2)

This muscle is far the largest of any of the muscles connecting appendages with the body. It arises in the dorsal part of the cephalothorax and occupies most of the space between the stomach and the side of the head cavity. Passing medio-ventrally it is inserted by a short strong tendon medio-dorsally on the proximal edge of the basipodite close to the insertion of depressor *a*. It moves the basipodite inwards and upwards thus acting as an adductor and rotator to the whole antenna.

(In *Astacus* this muscle is quite weak.)

Musculus exopoditis adductor a II antennae (ex add a, Fig. 8)

This muscle has its origin on the medio-dorsal side of the basipodite. A short branch is inserted on the proximal edge of the exopodite or squame. The remainder of the muscle is inserted along the middle of the squame for about half its length on the dorsal side.

Musculus adductor exopoditis b II antennae (ex add b, Fig. 8)

Arises on the soft connection between the exopodite and the basipodite near the point of articulation. It is inserted along the mid-line of the squame on the ventral side. The two adductors pull the squame inwards and upwards.

Musculus exopoditis abductor II antennae (ex abd, Fig. 8)

Arises ventrally in the proximal part of the basipodite. It lies on the

ventral side of the basipodite and is inserted ventrally in the proximal part of the exopodite. The whole muscle is a very strong ribbon of fibres. It acts as an antagonist to the adductors.

Musculus reductor ischiopoditis II antennae (red i, Fig. 8)

Arises ventrally in the basipodite near the origin of the abductor of the exopodite. It is inserted ventrally on the proximal edge of the first joint of the endopodite near the carpopodite. It is a flat muscle running parallel with the abductor of the exopodite. It moves the first joint partly ventrally in the sagittal plane and partly medially.

Musculus meropoditis II antennae (mer, Fig. 8)

It has its origin on the dorso-lateral side of the basipodite, and is inserted, slightly diminished in size, on the proximal edge of the first joint of the endopodite in the middle of the ventral side. It opposes the action of the reductor of the ischiopodite.

Musculus carpopoditis II antennae (carp, Fig. 8)

There is only one muscle moving the carpopodite, which almost fills the segment in which it occurs. It arises in the proximal part of the first joint of the endopodite and is inserted dorsally in the middle of the proximal edge of the carpopodite. As a matter of fact the carpopodite is only visible on the ventral side, and as the propodite practically unites dorsally with the first joint of the endopodite, this muscle might just as well be said to be inverted on the proximal edge of the propodite. It produces an elevation of the carpopodite and with it the propodite.

(In *Astacus* there are two muscles moving the carpopodite.)

Musculus propoditis II antennae (prop, Fig. 8)

This is a broad but fairly weak ribbon of fibres covering the ventral side of the carpopodite. It has its origin on the ventral proximal edge of the carpopodite and is inserted on the ventral proximal edge of the propodite. As the first joint of the endopodite and the propodite are united dorsally this muscle really acts as an antagonist to the muscle of the carpopodite.

Musculus flexor dactylopoditis II antennae (flex 5, Fig. 8)

Arises dorso-laterally in the proximal half of the propodite and is inserted laterally on the proximal edge of the flagellum by a very short tendon. It moves the flagellum outwards.

Musculus extensor dactylopoditis II antennae (ext 5, Fig. 8)

Arises medio-ventrally in the proximal part of the propodite and is inserted medially on the proximal edge of the flagellum by a very short tendon. It is the antagonist of the flexor of the flagellum or dactylopodite.

The Mandible (Fig. 9)

As with the eyes and the first antenna, the mandible cannot be fitted into a general plan of musculature. The main body of the mandible consists of a specialized protopodite, but it is firmly fixed by two points of articulation (x and xx, Fig. 9), so that it has no power of rotation. Hence it is impossible to work out the homologies of the muscles that move it with the muscles that move the protopodite in other appendages, and the simple terms adductor and abductor are used instead.

In *Astacus* the same muscles are found to move the mandible as occur in *Pandalus*, but they vary considerably in their relative importance. Muscles also occur within the palp in *Astacus* which are missing in *Pandalus*.

Musculus abductor mandibulae (abd, Fig. 9)

Arises as a very large tendon which is a lateral continuation of the anterior fascia (fa₁, Fig. 9). It is inserted by a broad band of muscle fibres on the dorso-lateral part of the mandible on the inner side. This muscle is very strong and quite conspicuous.

Musculus adductor posterior mandibulae (add p, Fig. 9)

Arises on the dorsal surface of the carapace posterior to the insertion of the anterior dorso-ventral muscles, by a small cluster of muscle fibres. It proceeds as a long thin tendon to its insertion on the caudal proximal edge of the mandible.

(In *Astacus* this muscle is very strong and is the principal adductor.)

Musculus adductor anterior mandibulae (add a, Fig. 9)

This is the most important of the mandibular muscles. It arises without a tendon ventro-laterally partly on the anterior fascia (fa₁) and partly on the head apodeme and is inserted ventrally on the inner side of the mandible. It occupies a large part of the interior of the mandible. It approximates the masticatory surfaces, in which action it is assisted by the posterior adductor.

(In *Astacus* this muscle is comparatively weak.)

Musculi adductores laterales mandibulae (add 1, Fig. 9)

There are two of these on the lateral side of the mandible. They arise laterally on the head carapace and are inserted on the dorso-lateral side of the mandible. The posterior is much the stronger of the two and has its origin more dorsally than the anterior. They assist the anterior adductor in its function.

Musculus flexor palpi mandibulae (flex p, Fig. 9)

This muscle arises on the medial side of the mandible just where the mandibular process joins the main body. It is inserted on the medial proximal edge of the first segment of the palp, which it moves towards the median plane.

Musculus extensor palpi mandibulae (ext p, Fig. 9)

It arises on the ventral side of the body of the mandible near the origin of the flexor and is inserted on the lateral proximal edge of the first segment. It is about the same size as its antagonist, the flexor.

The First Maxilla (Fig. 10)

In the first maxilla the exopodite has vanished and the endopodite (En, Fig. 10) is reduced to an unsegmented remnant. The two joints of the protopodite, however, are well developed and are used in the reception of food. The coxopodite has no firm articulation so that it can rotate freely and other muscles besides the promotor and remotor appear to help in this rotation.

Musculus promotor I maxillae (prom, Fig. 10)

Arises laterally on the anterior fascia and passes dorso-laterally as a flat ribbon of muscle to its insertion in the proximal part of the coxopodite. It raises and rotates the coxopodite.

Musculus remotor (a and b) I maxillae (rem [a and b], Fig. 10)

There are two branches, both without tendinous material, and both inserted in the proximal part of the coxopodite ventral and medial to the promotor. The dorsal branch (rem a, Fig. 10) arises by the side of the promotor and the anterior fascia and spreads out slightly toward its insertion. The ventral branch (rem b, Fig. 10) has its origin on the anterior fascia posterior to that of the promotor. It is cylindrical in form and the stronger branch of the two. The two branches together oppose the action of the promotor.

Musculus adductor lateralis coxopoditis I maxillae (add l c, Fig. 10)

Arises laterally on the head carapace near the angle between the carapace proper and the head apodeme. It passes as a broad ribbon to be inserted without a tendon on the medio-dorsal side of the coxopodite. It elevates the medial part of the coxopodite and moves it towards the opening of the mouth.

Musculus adductor medialis coxopoditis I maxillae (add m c, Fig. 10)

The origin is on the lateral side of the anterior fascia and the insertion is on the medial side of the distal part of the coxopodite. This muscle lies ventral to all the others in the appendage. It assists the lateral adductor in its action.

Musculus abductor coxopoditis I maxillae (abd c, Fig. 10)

This muscle arises laterally on the head carapace just ventral to the origin of the lateral adductor. It is cylindrical in form and without a tendinous structure. It acts as an antagonist to the adductors.

Musculus levator I maxillae (lev, Fig. 10)

Arises laterally on the anterior fascia ventral and anterior to the origin of the promotor and is inserted medio-dorsally on the proximal edge of the basipodite. It is a flat ribbon without tendinous material. It moves the basipodite upwards and inwards about an axis a little inclined to the sagittal plane.

Musculus depressor I maxillae (depr, Fig. 10)

This muscle is somewhat stronger than its antagonist, the levator. It lies ventral and parallel to the levator. The origin is on the anterior fascia ventral and anterior to that of the levator and it is inserted medio-ventrally on the proximal edge of the basipodite.

Musculus adductor endopoditis (add, end)

This muscle is a flat, fan-shaped, thin ribbon of fibres which has its origin on the dorsal proximal edge of the basipodite, and is inserted in the proximal half of the endopodite. It produces an approximation of the endopodite to the median line but has no muscle opposing it.

The Second Maxilla (Fig. 11)

As in the first maxilla this appendage is much flattened and is used for food reception. Again both coxopodite and basipodite are well

developed, especially the latter. The endopodite (En, Fig. 11) is reduced to an unsegmented remnant. As in the first maxilla there is no definite hinge joint between the coxopodite and the body-wall, hence a certain amount of rotation is possible and there is an adductor as well as the regular muscles of the protopodite. In addition to the ordinary parts there is a long, boomerang-shaped expansion, the scaphognathite, which extends back over the gills and moves in an S-shape, thus keeping a stream of water passing through the branchial chamber. In connection with this scaphognathite there is a special group of muscles, the respiratory muscles, and two flexors.

The scaphognathite has been variously interpreted as an epipodite, an exopodite or a combination of epipodite and exopodite. A study of the muscles seems to suggest that this last is the true interpretation. The epipodite in the first maxilliped is superficially very similar to the scaphognathite but it contains no muscles that correspond to the flexors of the scaphognathite. Now the exopodite of the first maxilliped in *Astacus* contains an abductor of the flagellum which very closely resembles the superior flexor of the scaphognathite in *Pandalus*. In *Pandalus* the abductor of the flagellum is much reduced while the superior flexor is lacking in *Astacus* although both animals possess an inferior flexor of the scaphognathite. Hence the homology between the exopodite of the first maxilliped and the anterior part of the scaphognathite is more clearly shown by comparing the mouth parts of the two forms. Now the epipodite of the first maxilliped is moved by two attractors which bear a striking resemblance to the respiratory muscles moving the posterior part of the scaphognathite especially *musculus respiratorius quintus* (re, Fig. 11) and *musculus respiratorius septimus* (rg, Fig. 11). It would appear, then, that the anterior part of the scaphognathite represents the exopodite and the posterior part represents the epipodite.

Musculus promotor II maxilla (prom, Fig. 11)

This is a cylindrical muscle which has its origin on the endopleurite, and narrows rapidly to be inserted by a thin strong tendon on the proximal edge of the coxopodite. It moves the latter dorso-medially.

Musculus remotor II maxillae (rem, Fig. 11)

Arises by a broad surface on the epimeral plate between the last cephalic and the first thoracic segments. It narrows to a long, thin, strong tendon which passes between the respiratory muscles to its insertion on the proximal edge of the coxopodite, ventral and lateral to the promotor. It moves the coxopodite dorso-laterally but appears to be much stronger than its antagonist, the promotor.

Musculus adductor coxopoditis II maxillae (add c, Fig. 11)

This is a very small muscle. It has its origin in a tendon on the endosternite just ventral to the depressor and is inserted by a tendon on the proximal edge of the coxopodite close to the promotor. It moves the coxopodite medially and assists the promotor to oppose the remotor.

Musculus depressor II maxillae (depr, Fig. 11)

This muscle arises on the ventro-medial part of the endosternite near the adductor and breaks through the coxopodite to be inserted on the proximal edge of the basipodite. It moves the basipodite inwards in the horizontal plane.

(In *Astacus* this muscle has two branches.)

Musculus adductor endopoditis II maxillae (add end, Fig. 11)

This is a flat ribbon of fibres arising in the proximal part of the basipodite and inserted in the medio-distal part of the endopodite. It moves the endopodite inwards in the horizontal plane and its only antagonist is the membrane at the base.

Musculus flexor scaphognathitis inferior II maxillae (flex scg sup, Fig. 11)

It arises laterally in the proximal part of the basipodite as a flat ribbon of fibres and spreads out inside the scaphognathite to its insertion on the ventral side. It is irregularly branched. It bends the anterior part of the scaphognathite dorsally and inwards.

Musculus flexor scaphognathitis superior II maxillae (flex scg sup, Fig. 11)

Arises laterally in the distal part of the basipodite and is attached on the medial side of the scaphognathite. It is unbranched. Apparently it assists the inferior flexor in its work of bending the scaphognathite.

(This muscle does not occur in *Astacus*.)

Musculi respiratorii II maxillae (r [a, b, d, e, f, g], Fig. 11)

These muscles form the principal mass of musculature in the second maxilla and combine with the flexor and extensor of the scaphognathite to move the latter in an S shape over the gills and so help in respiration. They also act to some extent as antagonists of the depressor.

The first of these muscles, *musculus respiratorius primus* (ra, Fig. 11) arises dorso-laterally on the anterior edge of the endopleurite. It is inserted dorsally on the distal edge of the swelling in the skeleton produced by this mass of muscles. The second muscle, *musculus respiratorius secundus* (rb, Fig. 11) appears to represent both the second and third muscles as they occur in *Astacus*. It proceeds under the first

muscle, narrowing somewhat, and is inserted on the lateral proximal side of the skeletal swelling. To avoid re-naming I have called that muscle which is really the third in *Pandalus* the *musculus respiratorius quartus*, because it is evidently homologous with the muscle bearing that name in *Astacus*. Similarly that muscle which is fourth in *Pandalus* has been called *musculus respiratorius quintus*, and so on. The fourth respiratory muscle, then (rd, Fig. 11) arises medio-dorsally on the endopleurite, ventral to the second muscle and is inserted laterally on the distal part of the skeletal swelling. This muscle and the sixth are the two strongest of the whole group. The fifth muscle, *musculus respiratorius quintus* (re, Fig. 11) lies under the fourth and runs almost parallel with it. It arises on the ventro-medial part of the endosternite, by the side of the depressor, and is inserted under the fourth muscle in the distal part of the skeletal swelling. The sixth muscle, *musculus respiratorius sextus* (rf, Fig. 11) is the largest muscle in the group. It has its origin on the endosternite partly ventral to the fifth muscle and the depressor, and partly anterior to them. It lies ventral to all the other muscles and is inserted ventro-laterally in the proximal part of the skeletal swelling, ventral to the second muscle. The seventh muscle (rg, Fig. 11) has its origin on the distal edge of the coxopodite and passes under the fourth muscle to be inserted ventrally at the distal end of the skeletal swelling. In *Astacus* this seventh muscle has its origin on the endosternite. The resemblance between the seventh muscle and the attractor of the mastigobranchia or epipodite which occurs in the maxillipeds and pereopods is very striking.

The First Maxilliped (Fig. 12)

The first maxilliped more closely resembles the maxillae than a typical thoracic appendage. The joints only show a weak tendency to be hinged. The coxopodite and basipodite are immovably fused together in a way that does not occur as strongly in any other thoracic appendage, though there is a slight tendency of a similar kind in the second maxilliped. The basal segment of the exopodite shows the wide extension, or lobe of Boas, which is characteristic of all Caridea. One attractor of the epipodite, that which moves the anterior part (attr ep b, Fig. 12) only occurs in this appendage while the other attractor, that which moves the posterior part (attr ep a, Fig. 12) persists throughout the maxillipeds and all the pereopods but the last; in fact it is found in every thoracic appendage which bears an epipodite or that special kind of epipodite, the mastigobranchia. Now it has been shown that in the development of *Penaeus* three bud-like outgrowths appear on the proximal part of most of the thoracic limbs. The most distal of these early becomes

bilobed. It is believed that in the second maxilliped the distal lobe, which lies in front of the proximal one, develops into the podobranch and disappears in the other appendages, while the proximal lobe becomes the epipodite. Then in the first maxilliped the distal lobe remains simple and becomes the distal part of the laminar epipodite. This theory is supported by the muscles, for it is only in the first maxilliped that the distal lobe forms part of the epipodite and this is the only appendage that contains the *musculus attractor epipoditis b*. None of the muscles show chitinous tendons.

Musculus promotor medialis I pedis maxillaris (prom m, Fig. 12)

This muscle arises on the ventral side of the fused paraphragms of the first and second thoracic segments, and is inserted medio-dorsally on the proximal edge of the coxopodite. It is far the strongest muscle in the appendage. It moves the coxopodite upward or forward, and in toward the mid-line.

Musculus promotor lateralis I pedis maxillaris (prom l, Fig. 12)

It has its origin near the medial promotor on the ventral side of the paraphragms, and is inserted rostro-laterally on the proximal edge of the coxopodite. It opposes the medial promotor in its action as an adductor, but assists it in raising the appendage.

Musculus remotor I pedis maxillaris (rem, Fig. 12)

It arises ventrally on the endosternite and passes under the medial promotor and the attractor of the epipodite. Its insertion is near that of the lateral promotor on the rostro-lateral side of the proximal margin of the coxopodite. It opposes both promotors in their action of raising the appendage, but assists the lateral promotor to oppose the adductor action of the medial promotor.

(Schmidt specially comments on the absence of this muscle in *Astacus*.)

Musculus attractor epipoditis a I pedis maxillaris (attr ep a, Fig. 12)

This muscle arises laterally on the distal edge of the coxopodite and is inserted on the medial side of the epipodite where it is attached to the coxopodite. It raises the proximal end of the epipodite.

Musculus attractor epipoditis b I pedis maxillaris (attr ep b, Fig. 12)

It arises on the ventral side of the paraphragm just under the origin of the medial promotor and is inserted on the medial side of the epipodite near the insertion of the attractor *a*. It is a fairly strong muscle, and raises the epipodite, especially the distal end.

(Schmidt considers that this muscle may be derived from the remotor

which is lacking in *Astacus*. Since the remotor is present, however, in *Pandalus*, this is manifestly impossible.)

Musculus levator I pedis maxillaris (lev, Fig. 12)

Arises medially in the proximal part of the coxopodite, and is inserted laterally on the proximal edge of the basipodite. It moves the latter outward about an axis perpendicular to the transverse plane.

Musculus depressor I pedis maxillaris (depr, Fig. 12)

Arises medially in the proximal part of the coxopodite and is inserted medially on the proximal edge of the basipodite. It opposes the levator.

Musculus adductor endopoditis a I pedis maxillaris (add end a, Fig. 12)

It has its origin close to that of the levator in the proximal part of the coxopodite, and is inserted on the proximal edge of the endopodite. It moves the endopodite inward and downward, and, since the endopodite and exopodite are joined to a considerable degree, it also acts as an antagonist to the adductor of the exopodite.

(Schmidt calls this muscle the reductor of the endopodite, but does not mention the other adductor of the endopodite, nor the adductor of the exopodite.)

Musculus adductor endopoditis b I pedis maxillaris (add end b, Fig. 12)

This is a very small muscle having its origin on the lateral side of the basipodite, and its insertion in the middle of the proximal half of the endopodite. It moves the endopodite and with it the exopodite toward the mid-line.

Musculus adductor exopoditis I pedis maxillaris (add ex, Fig. 12)

This is a fairly large muscle having its origin in the proximal part of the coxopodite close to the levator. It runs more or less parallel to the reductor of the endopodite to its insertion on the proximal edge of the exopodite. It moves the latter inward and upward, in which it is assisted by the adductor of the endopodite.

Musculus abductor exopoditis I pedis maxillaris (abd ex, Fig. 12)

It arises laterally on the proximal edge of the basipodite and runs along the proximal edge of the exopodite to its insertion in the middle of the proximal edge of the exopodite. It opposes the adductor of the exopodite.

Musculus abductor flagelli exopoditis I pedis maxillaris (abd fl, Fig. 12)

This muscle is reduced to the merest vestige. It consists of a few

short fibres situated medially in the basal lobe of the exopodite. It arises on the ventral side a short distance below the base of the flagellum and is inserted at the base of the flagellum. It is so small and weak that it can have but little use.

Musculus flagellaris exopoditis I pedis maxillaris (flag, Fig. 12)

This muscle arises in the basal lobe and more or less fills the flagellum up which it passes almost to the tip, giving off fibres at each annulation. It bends the flagellum in all directions.

(In *Astacus* this muscle arises in the first segment of the flagellum. A consideration of this fact and the position of the remnant of the abductor flagelli seems to suggest that this basal lobe consists of the true basal segment and the first joint of the flagellum fused together.)

The Second Maxilliped (Fig. 13)

In the second maxilliped true hinge joints first appear, especially in the endopodite. The exopodite is reduced to an annulated flagellum. The first segment of the endopodite is completely fused with the basipodite and shows no musculature. Unlike the muscles of the third maxilliped and the pereopods none of the muscles of the second maxilliped except those of the dactylopodite show any tendinous parts. There is a flat epipodite and a podobranchia.

(In *Astacus* there is no epipodite, the muscles are inserted by tendons, and the exopodite is jointed rather than annulated.)

Musculus promotor II pedis maxillaris (prom, Fig. 13)

The origin is on the endosternite, and it is inserted medially in the distal part of the coxopodite. It lies ventral to the two branches of the depressor. It moves the coxopodite forward and inward toward the median line.

Musculus remotor II pedis maxillaris (rem, Fig. 13)

Has its origin on the lateral side of the endosternite and passes under the levator to be inserted laterally in the distal part of the coxopodite. It has somewhat the same form and size as its antagonist, the promotor.

Musculus levator (a and b) *II pedis maxillaris* (lev [a and b], Fig. 13)

This muscle has two branches which arise quite separately but are inserted close together. The principal branch (lev a, Fig. 13) takes its origin mostly on the ventral side of the paraphragm and a little on the endosternite. It is fixed laterally to the proximal edge of the basipodite.

The smaller branch (lev b, Fig. 13) arises rostro-medially on the proximal edge of the coxopodite and is inserted by the side of the principal branch. The two branches together move the basipodite outward and forward.

Musculus depressor (a and b) II pedis maxillaris (depr [a and b], Fig. 13)

As in the levator so in the depressor there are two branches, one arising in the body and the other in the coxopodite. The main branch (depr a, Fig. 13) arises partly on the ventral side of the paraphragm near levator *a* and partly on the lateral part of the endosternite. It is inserted medially on the proximal edge of the basipodite. The smaller branch (depr *b*, Fig. 13) has its origin medially on the proximal edge of the coxopodite near levator *b* and is inserted on the proximal edge of the basipodite just dorsal to the insertion of the main branch. The two branches work together to move the basipodite inward and backward.

Musculus attractor epipoditis II pedis maxillaris (attr ep, Fig. 13)

This muscle arises laterally on the distal edge of the coxopodite and is inserted on the proximal edge of the epipodite. It moves the epipodite upward and backward about an axis somewhat inclined to the sagittal plane.

Musculus flagellaris exopoditis II pedis maxillaris (flag, Fig. 13)

This muscle arises on the proximal edge of the basipodite and passes up the flagellum for the greater part of its length giving off fibres at each annulation. It bends the flagellum.

It appears to represent both the *abductor flagelli exopoditis* and the *flagellaris exopoditis* of *Astacus*.

Musculus productor meropoditis II pedis maxillaris (prod₂, Fig. 13)

It arises ventrally in the proximal part of the fused ischiopodite and basipodite, and is inserted dorso-laterally on the proximal edge of the meropodite. It moves the meropodite forward.

Musculus reductor meropoditis II pedis maxillaris (red₂, Fig. 13)

This muscle is approximately the same size as its opponent, the productor of the meropodite. It arises medially by a broad surface on the dorsal side of the fused basipodite and ischiopodite. It narrows somewhat towards its insertion, which is in the ventro-medial part of the proximal edge of the meropodite.

Musculus abductor carpoditis II pedis maxillaris (abd₂, Fig. 13)

It takes its origin dorso-laterally on the proximal edge of the mero-

podite and is inserted laterally on the proximal edge of the carpopodite. It moves the latter outward about an axis perpendicular to the transverse plane.

Musculus adductor carpopoditis II pedis maxillaris (add₃, Fig. 13)

It arises ventro-laterally on the proximal edge of the meropodite under its antagonist, the abductor of the carpopodite which it approximately equals in size. It narrows somewhat and is inserted medially on the proximal edge of the carpopodite which it moves inward.

Musculus productor propoditis II pedis maxillaris (prod₄, Fig. 13)

It arises dorso-laterally on the proximal edge of the carpopodite and passes diagonally across the segment to be inserted dorso-medially on the proximal edge of the propodite. It moves the propodite forward.

Musculus reductor propoditis II pedis maxillaris (red₄, Fig. 13)

This is very similar to its antagonist, the productor of the propodite, in size and shape. It arises on the ventro-lateral side of the carpopodite and is inserted ventro-medially on the proximal edge of the propodite.

Musculus productor dactylopoditis II pedis maxillaris (prod₅, Fig. 13)

It arises in the middle of the ventral side on the proximal edge of the propodite. It is strongly flattened and narrows somewhat rapidly to be inserted by a strong tendon in the middle of the ventral side of the dactylopodite. It moves the latter forward.

Musculus reductor dactylopoditis II pedis maxillaris (red₅, Fig. 13)

This is a broader muscle than its antagonist, the productor, but not appreciably stronger. It has its origin ventro-medially near the proximal edge of the propodite, and is inserted about the middle of the ventral side of the dactylopodite by a short tendon.

The Third Maxilliped (Fig. 14)

This maxilliped is very different from the other two in that it is pediform instead of being a mouth part. The exopodite has completely disappeared and with it, of course, the muscles that move it. The epipodite is present and has that special form to which Lankaster gives the name "mastigobranchia." That is to say it is a curved bar with a wide head fringed with setae at the end where it joins the coxopodite, and with a hook on the other end which grasps a bundle of very long setae, the coxopodic setae, on the next posterior appendage. Only the head of this bar is shown in the diagram. Evidently the hook is moved

up over the coxopodic setae and probably cleans them. Just why this is necessary is not clear, but it has been suggested that the setae have a respiratory function. The reduction in the number of segments in the endopodite is typical of the Caridea. The ischiopodite seems to have disappeared and the meropodite has fused with the basipodite. The dactylopodite is also missing altogether.

Musculus promotor III pedis maxillaris (prom, Fig. 14)

Since the third maxilliped is pediform one would naturally expect the muscles to be more like those of the pereopods than those of the second maxilliped. This tends to be the case in all the muscles moving the protopodite, but is more obviously so in the promotor than in any other muscle. Instead of arising only on the paraphragm or the endosternite it has its origin on the epimeral plate. It is a fairly large leaf-shaped muscle and is inserted rostro-medially on the coxopodite by a short, strong tendon. It moves the coxopodite forward.

Musculus remotor III pedis maxillaris (rem, Fig. 14)

This muscle has its origin laterally on the endosternite and is inserted without a tendon caudo-laterally on the proximal edge of the coxopodite. It is much weaker than its opponent, the promotor, and closely resembles the remotor of the second maxilliped.

Musculus levator (a, b and c) III pedis maxillaris (lev [a, b and c], Fig. 14)

The levator has one principal branch and two smaller branches. The main branch (lev a, Fig. 14) arises on the ventral part of the endosternite and is inserted rostro-laterally on the basipodite by a large, strong tendon. Its insertion is further strengthened by a wing-like extension of the wall of the basipodite. The small median branch (lev b, Fig. 14) has its origin rostro-medially on the proximal edge of the coxopodite near the insertion of the promotor. It joins the main branch and is inserted with it. The lateral branch (lev c, Fig. 14) is almost as big as the main branch. It arises rostro-laterally partly in the proximal part of the coxopodite and partly on the epimeral plate, and is inserted by the same tendon as the other two branches. The whole levator moves the basipodite outward and forward, about an axis somewhat inclined inward toward the transverse plane.

Musculus depressor (a and b) III pedis maxillaris (depr [a and b])

This muscle is distinctly stronger than its opponent, the levator, but has only two branches although one of these is much rebranched. The smaller of these two branches (depr b, Fig. 14) arises partly on the ventral part of the endosternite, and partly rostro-medially on the

proximal edge of the coxopodite. It is inserted rostro-medially on the proximal edge of the basipodite just by the insertion of the main branch. The bulk of this main branch (depr a, Fig. 14) has its origin laterally on the epimeral plate. Some of the fibres arise on the ventral side of the paraphragms (depr a₂, Fig. 14), some on the endosternite, some caudally in the middle of the proximal edge of the coxopodite, and a side branch (depr a₁, Fig. 14) has its origin caudo-laterally in the proximal part of the coxopodite. All these parts of the main branch unite and are inserted by a long, strong, chitinous tendon caudo-medially on the proximal edge of the basipodite. The whole depressor moves the basipodite, and with it the united ischiopodite and meropodite, inward and somewhat backward.

Musculus attractor mastigobranchia III pedis maxillaris (attr mast, Fig. 14)

This muscle is homologous with the attractor of the epipodite in the second maxilliped. It has its origin laterally on the distal edge of the coxopodite and is inserted on the proximal edge of the flattened head of the mastigobranchia. It raises the mastigobranchia and moves the whole curved rod dorsally, so that the little hook on the end brushes up over the coxopodic setae.

Musculus productor carpopoditis III pedis maxillaris (prod₃, Fig. 14)

As already stated the basipodite, ischiopodite and meropodite are fused together, so that the first muscles of the endopodite are those which move the carpopodite. The productor arises rostrally in the proximal part of the meropodite. A tendon runs up the middle of the muscle and is inserted rostrally on the proximal edge of the carpopodite. The fibres of the muscle are grouped in bundles and each bundle is inserted separately on the long main tendon. This muscle moves the carpopodite forwards about an axis which is at right angles to the sagittal plane.

Musculus reductor carpopoditis III pedis maxillaris (red₃, Fig. 14)

This muscle is longer and thinner than its antagonist, the productor, but has essentially the same structure. It arises caudally in the basipodite and the proximal part of the meropodite, and the bundles of fibres are inserted on a long strong tendon which, in its turn, is inserted medio-caudally on the proximal edge of the carpopodite.

Musculus extensor propoditis III pedis maxillaris (ext₄, Fig. 14)

It has its origin rostro-laterally in the proximal part of the carpopodite and is attached by a long tendon, which runs up the middle of the

muscle, to the rostro-lateral side of the propodite. It moves the propodite a little forward as well as outward.

Musculus flexor propoditis III pedis maxillaris (flex, Fig. 14)

This muscle is about the same size and strength as its opponent, the extensor. It has its origin medio-caudally in the proximal part of the coxopodite. The bundles of fibres are attached to a long tendon which is inserted medially on the proximal edge of the propodite.

The Pereiopods

As regards the musculature of the coxopodite and basipodite the pereiopods correspond almost exactly with the third maxilliped. There is no trace of an exopodite in any of the walking legs, so that, of course, none of its muscles occur. The endopodite, on the other hand, is always well developed with strong muscles. In the protopodite, the principle of articulation already referred to is found, that is the axis of motion of one joint is perpendicular to that of the preceding joint, thus allowing considerable freedom of motion. The muscles all have their origin directly, but they are nearly all inserted with tendons, and many are supported and considerably strengthened by heavy chitinous tendons that run down the centre of the muscle. Two exceptions to this last rule are the attractor of the mastigobranchia and the remotor. The mastigobranchia, with its muscle, is found in all the pereiopods except the fifth.

The first two pereiopods are more or less specialized, but the last three are all essentially alike and more generalized in structure. The third pereiopod will therefore be described first, and then the peculiar variations found in the first and second can be dealt with more simply.

The Third Pereiopod

Fig. 17

This is the most substantial of the walking legs. The endopodite consists of five joints, the last, or dactylopodite, being curved and shaped somewhat like a cat's claw with a serrated edge. There are very few setae, except the cluster of coxopodic setae.

Musculus promotor III pereiopoditis (prom, Fig. 17)

As in the third maxilliped this is a leaf-shaped muscle having its origin on the epimeral plate of the sixth thoracic segment. It is inserted by means of a short, strong tendon, rostro-medially on the proximal edge of the coxopodite and moves the latter forward.

Musculus remotor III pereiopoditis (rem, Fig. 17)

It has its origin laterally on the endosternite and passes as a flat

ribbon of muscle to be inserted caudo-laterally on the proximal edge of the coxopodite. It is weaker than its opponent, the promotor.

(In *Astacus* this muscle has three distinct branches.)

Musculus levator (a, b and c) III pereopoditis (lev [a, b and c], Fig. 17)

The levator has the same three branches in the pereopod as in the third maxilliped, except that the two branches "a" and "c" are about equal in strength. One of these two (lev *a*, Fig. 17) has its origin partly on the ventral side of the endosternite and partly on the paraphragm and is inserted rostro-laterally on the basipodite by a short strong tendon. The lateral branch (lev *c*, Fig. 17) arises rostro-laterally mainly on the epimeral plate with a few fibres in the proximal part of the coxopodite. It passes diagonally over levator *a* and is inserted rostral to the latter by the same short, stout tendon. The smaller median branch (lev *b*, Fig. 17) has its origin rostro-medially on the proximal edge of the coxopodite and is inserted by a short tendon near the other two branches. The whole muscle is very strong and serves to move the basipodite outward and forward.

Musculus depressor (a and b) III pereopoditis (depr [a and b], Fig. 17)

The muscle as a whole is stronger than its antagonist, the levator, but (as in the third maxilliped) it has only two branches although one of these is much redivided and its origin covers a large area. The bulk of the larger branch (depr *a*, Fig. 17) arises laterally on the epimeral plate, part of it (depr *a*₁, Fig. 17) has its origin caudo-laterally in the proximal part of the coxopodite, and part (depr *a*₂, Fig. 17) arises on the ventral side of the paraphragm while a few fibres arise on the endosternite, and a few in the middle of the proximal part of the coxopodite. All these slips of the main branch unite and are inserted by a long strong tendon caudo-medially on the proximal edge of the basipodite. The smaller side branch (depr *b*, Fig. 17) arises partly on the ventral part of the endosternite, but mainly rostro-medially in the proximal part of the coxopodite. The depressor as a whole pulls the basipodite downward and backward and so raises the body.

Musculus attractor mastigobranchia III pereopoditis (attr mast, Fig. 17)

As in the maxillipeds this muscle has its origin on the distal edge of the coxopodite and is inserted on the proximal edge of the mastigobranchia. Its action is the same as in the third maxilliped.

Musculus reductor ischiopoditis III pereopoditis (red₁, Fig. 17)

It arises partly rostrally, partly caudally in the proximal part of the basipodite and is inserted by a flat tendon caudo-laterally on the proximal

edge of the ischiopodite. It moves the latter backward about an axis lying in the transverse plane.

Musculus reductor meropoditis III pereiopoditis (red₂, Fig. 17)

It arises dorsally in the ischiopodite and occupies about half the joint. It is inserted by a flat tendon medially on the proximal edge of the meropodite. It moves the latter backward about an axis lying in the transverse plane. Instead of working at right angles to the muscle of the previous joint it acts in the same plane, thus breaking the general rule. Both reducers are very similar in shape in *Astacus*, and Schmidt suggests that they find their opposition in the weight of the body resting on the first joints of the endopodite. This seems a probable enough explanation since the legs are always carried well forwards, both in *Astacus* and *Pandalus*.

Musculus abductor carpopoditis III pereiopoditis (abd₃, Fig. 17)

It arises by a broad surface anteriorly in the distal part of the meropodite, and is inserted laterally by a long tendon on the proximal edge of the carpopodite. It is very much smaller than its opponent, the adductor. It really acts as an extensor of the carpopodite rather than as an abductor.

Musculus adductor carpopoditis III pereiopoditis (add₃, Fig. 17)

This is a very large muscle which almost completely fills such space as is left in the meropodite by the abductor. Its fibres arise posteriorly and a few anteriorly throughout the greater part of the joint and are attached to a strong tendon running up the middle. By means of this long flat tendon it is inserted medially on the proximal edge of the carpopodite. It moves the latter inward and backward and is probably opposed, not only by the much weaker abductor, but also somewhat by the weight of the body.

Musculus productor propoditis III pereiopoditis (prod₄, Fig. 17)

It has its origin on each side of the anterior surface of the carpopodite throughout the greater part of this joint, the fibres being attached to a long flat tendon which is inserted rostrally on the proximal edge of the propodite. It moves the propodite forward.

Musculus reductor propoditis III pereiopoditis (red₄, Fig. 17)

It has a position and form corresponding to its opponent, the productor, but is somewhat weaker. It arises by a broad surface on the posterior side of the carpopodite and is inserted caudally on the propodite by means of a long flat tendon.

Musculus abductor dactylopoditis III pereiopoditis (abd₆, Fig. 17)

The fibres arise laterally for nearly the whole length of the propodite and are inserted by means of a long flat tendon laterally on the proximal edge of the dactylopodite. The muscle serves to move the dactylopodite outward.

Musculus adductor dactylopoditis III pereiopoditis (add₆, Fig. 17)

It is slightly stronger but similar in size and shape to its opponent, the abductor. The fibres arise partly rostrally and partly caudally throughout the whole medial side of the propodite. By means of a long flat tendon the muscle is inserted medially on the proximal edge of the dactylopodite.

The First Pereiopod**Fig. 15**

This is the leg which corresponds to the great claw of the crayfish, but it is very poorly developed in *Pandalus*, being much smaller and weaker than the other pereiopods. Superficially it does not appear to be chelate at all, but a close examination of the tip of the propodite reveals two minute spines and one of these is jointed. Evidently this is all that remains of the great claw, but no muscles could be found in connection with it. All the muscles of the coxopodite and basipodite are essentially the same as those described for the third pereiopod. The muscles of the endopodite are also similar except for the absence, already referred to, of muscles in the propodite; and the fact that the abductor of the carpopodite (abd₃, Fig. 15) more closely resembles the adductor (add₃, Fig. 15) in size and shape, in the first pereiopod than it does in the third.

The Second Pereiopod**Fig. 16**

The structure of the endopodite of this pereiopod varies considerably from the general type. The two legs of the pair differ a great deal in length, the left one being one-third or nearly half as long again as the right. In the figure only the right one is shown. The ischiopodite is longer proportionately than in a typical pereiopod and has a furrow with a peculiar row of stout plumose setae extending about half-way from the basipodite up the medial side. The meropodite is faintly annulated at the distal end but it is in the carpopodite that the greatest variation is found. This has become much divided to form a great number of small joints. At the proximal end these are only annulations, but they gradually deepen to become very pronounced joints each with separate muscles of its own. The right leg has eighteen to twenty-one

of these annulations and joints and the left leg has nearly sixty. The propodite is shorter and stouter than in the third pereopod and is produced at the distal end to form a claw with the dactylopropodite.

Essentially the muscles of the coxopodite and basipodite correspond to those of the third pereopod as also do those moving the ischiopodite and the carpopodite. Allowing for a difference in the size of the ischiopodite there is also very little variation in the reductor of the meropodite (red., Fig. 16). It will only be necessary, then, to describe in detail the muscles found in the carpopodite and those moving the dactylopropodite.

The Muscles of the Joints in the Carpopodite

The first few gradually deepening annulations contain no muscle fibres. The first fibres are found in the right leg in a joint fourteen segments from the distal end of the carpopodite. I have therefore called this joint "No. 1" and numbered them from here to the end "Nos. 1 to 14." The muscles become gradually thicker toward the tip of the leg until they completely fill the thirteenth and fourteenth segments. Down the middle of the caudal side of these joints runs a ridge which serves for the attachment of these muscles. This will be referred to as the "caudal ridge." There are two sets of muscles, the extensors and flexors, corresponding to the productors and reducers of the typical pereopod.

Musculi extensores carpopoditis et propoditis II pereopoditis (ext [a and b] carp, ext [a and b] prop, Fig. 16)

There are two small extensors, each consisting of but a few fibres, to move each joint in the carpopodite. One of these arises in the joint immediately preceding that to be moved (ext *b* carp, Fig. 16) and the other in the joint before that (ext *a* carp, Fig. 16). Thus of the two extensors of the joint No. 12, one arises on the ridge in the middle of the caudal side of joint No. 10, passes over joint No. 11 and is inserted laterally on the proximal edge of joint No. 12. The other extensor has its origin on the ridge in joint No. 11, and is inserted in the middle of the lateral side of joint No. 12. The thirteenth and fourteenth segments contain similar extensors which move the propodite. One of these (ext *a* prop, Fig. 16) arises on the caudal ridge in the thirteenth segment and passes through the fourteenth to be inserted by a tendon laterally on the proximal edge of the propodite. The other (ext *b* prop, Fig. 16) arises caudally in the proximal part of the fourteenth segment and joins extensor *a* so that the two are inserted together.

Musculi flexores carpopoditis et propoditis II pereopoditis (flex [a and b] carp, flex [a and b] prop, Fig. 16)

In most of the joints of the carpopodite there is only one flexor but

in the last two or three joints there are two flexors. In every joint in which muscles occur, then, a small flexor (flex *a* carp, Fig. 16) arises medially in the proximal part of one joint and is inserted on the caudal ridge in the distal part of the next joint. That in the thirteenth segment is attached to the proximal edge of the fourteenth segment. In the last few joints another flexor (flex *b* carp, Fig. 16) arises rostrally on the medial side of one segment and is inserted medially on the proximal edge of the next segment. There are two similar flexors moving the propodite. One of these (flex *a* prop, Fig. 16) arises caudally in the proximal part of the fourteenth segment and is attached by a tendon rostrally to the proximal edge of the propodite. The other flexor (flex *b* prop, Fig. 16) arises medio-rostrally in the fourteenth segment and is attached by a short tendon caudally to the proximal edge of the propodite.

Musculus abductor dactylopoditis II pereio-poditis (abd₆, Fig. 16)

This muscle is very much smaller than its antagonist, the adductor. It arises caudally, medially and rostrally and is inserted by a long flat tendon medially on the proximal edge of the dactylopodite. It occupies most of the space left by the adductor.

Musculus adductor dactylopoditis II pereio-poditis (add₆, Fig. 16)

This muscle is short but very strong. It arises caudally, laterally and rostrally, occupying the greater part of the space in the propodite. A strong, flat tendon runs down the middle to which the fibres are attached and this is inserted laterally on the proximal edge of the dactylopodite. It moves the dactylopodite medially, enabling it to meet the extension of the propodite, so that the two together form a claw capable of grasping objects firmly.

Part II. THE MUSCULATURE OF THE ABDOMEN

A. *The Muscles of the Body*

The segments of the abdomen are freely movable, whereas those of the cephalothorax are fused together. Moreover, flexions of the abdomen are much used in swimming. These two factors contribute to making the abdominal body muscles much larger and stronger than the thoracic ones. In fact, except for the small spaces filled by the nerve cord and alimentary tract, almost the whole of the abdomen is occupied by muscles. As will appear in the detailed description, these muscles, especially the central ones are very complicated, the fibres intertwining and twisting to a great extent, thereby acquiring increased strength.

Ventral Muscles

As in the thorax the ventral muscles are divided into two layers. One of these (*vsa*, Fig. 1) is very simple, weak and flat, and is a direct continuation of the series of ventral superficial muscles in the thorax. The other layer, which again is subdivided into transverse and oblique muscles, lies deeper, and is much stronger and more complicated. In fact it comprises the main part of the abdominal muscle mass.

Musculi ventrales superficiales abdominis (*vsa* [1, 2; 2, 3; 3, 4; 4, 5; 5, 6], Fig. 18)

These are thin ribbons of muscle fibres which continue the superficial muscles of the thorax into the abdomen. Each one arises on the soft membrane just behind a segment and is inserted on the ventro-caudal edge of the next following segment. The two muscles of a pair lie close together, only leaving room between them for the nerve cord which runs down the middle of the ventral side of the body. The last muscle of the series (*vsa* 5, 6, Fig. 18) is an exception to these last two rules. It has its origin on the hard part of the fifth segment, close to the place of insertion of the last muscle (*vsa*, 4, 5, Fig. 18) and is inserted in the middle of the ventral side of the sixth segment. The two muscles of this pair have no space between them. The course of the fibres in the various muscles varies slightly from segment to segment but is more or less longitudinal, and they are all approximately equal in strength. There is no corresponding muscle joining the sixth segment and the telson.

The whole series of muscles helps to cause a flexion of the abdomen.

Musculi transversi abdominis (*tr a* [1, 2, 3, 4, 5, 6], Fig. 19, 20)

These muscles are the largest in the abdomen. They run partly transversely, and partly longitudinally, forming a strong framework or skeleton around which the oblique muscles twist. The first muscle of the series (*tr a*₁, Fig. 19, 20) has its origin in two or three different places. Part arises from the thoracic musculature by means of a tendon (*tr a*₁ *f*, Fig. 20). Part arises laterally in the first abdominal segment by a tendon (*tr a*₁ *s*, Fig. 20). The fibres of the former part run longitudinally, the fibres of the latter run laterally. The two fuse medially to form a dense muscle mass lying in the first abdominal segment. Ventral to these runs a large mass of muscle (*tr a*₁ *a*, Fig. 20) which terminates ventro-laterally at a tendon (*tr a*₁ *a*, Fig. 20).

The fibres in the second transverse muscle (*tr a*₂, Fig. 19, 20) pursue the same general direction as in this first muscle. The intersegmental part arises laterally in the first segment by a tendon (*tr a*₂ *ds*, Fig. 19, 20)

which fuses with the lateral origin of the first transverse muscle (tr a_1 s, Fig. 20). Thence the fibres follow a spiral course in a general transverse direction so that the muscle is lateral in one segment and median in the next. The two muscles of the pair are united in the second segment by transverse fibres. The segmental part is a slightly curved band of fibres joined to the skeleton laterally on each side of the second segment. Dorso-laterally there is an inner fusion of the lateral parts of the segmental muscles with the anterior part of the intersegmental muscles of the next segment. In the dorsal view this appears as a homogeneous mass (tr $a_2 +_3$, Fig. 19).

The third and fourth transverse muscles (tr a_3 , tr a_4 , Fig. 20) are similar in structure to the second. A dorsal view shows similar fusions of the fibres with those of the following muscle (tr $a_3 +_4$, tr $a_4 +_5$, Fig. 19).

The two last transverse muscles (tr a_5 , tr a_6 , Fig. 20) differ from the first four in that they have no segmental part. The intersegmental parts, however, correspond to those of the preceding muscles. It may be noted that the last muscle barely enters the sixth segment. There is no transverse muscle in the telson.

(In *Astacus* there is a second part of the sixth transverse muscle which is visible on the dorsal side as a transverse band of muscle fibres. This band is completely lacking in *Pandalus*.)

Musculi obliqui anteriores

This system of muscles does the greater part of the work of flexing the abdomen. It has already been noted that the transverse muscle system forms a scaffolding for these oblique muscles. By stretching over several segments at the same time as they twist about this framework the oblique muscles attain a very considerable power of contraction, much greater than would be possible in a purely segmental arrangement as in the superficial muscles. Any motion of the abdomen other than flexion or extension is prevented by the firm structure of the articulations.

Musculus obliquus anterior 1 (obl a_1 , Fig. 19, 20)

This muscle has its origin on the flat tendon which terminates the anterior thoracic muscle (obl f , Fig. 20). It is a flat sheet of muscle fibres which passes backward and laterally to be inserted laterally by flat tendons on the rostral and caudal sides of the first abdominal segment. Towards this insertion the fibres become fused by tendinous material, forming a dense lateral mass of sinew. The remainder passes dorso-medially and is inserted medially by a tendon (obl a_1 f , Fig. 19).

Musculus obliquus anterior 2 (obl a_2 , Fig. 19, 20)

The second anterior oblique muscle arises laterally on the first trans-

verse muscle, around which it twists medially on the dorsal side. It then passes ventrally and is somewhat united to the other muscle of the pair by a small tendon. Next it runs caudally and laterally, and is finally inserted by tendons partly laterally in the caudal part of the second segment and partly dorso-medially in the caudal part of the third segment, where the two muscles of the pair unite by a tendon (obl $a_2 f$, Fig. 19).

Musculus obliquus anterior 3 (obl a_3 , Fig. 19, 20)

This muscle arises ventro-laterally in the rostral part of the first abdominal segment, and is united here with the tendon by which *musculus obliquus anterior 1* is inserted, and also with the lateral parts of the first and second transverse abdominal muscles. Turning dorso-laterally and then medially, it twists around the longitudinal fibres of the second transverse muscle and passes toward the ventral side. Thence it runs caudally and laterally. It is inserted by tendons partly on the caudal edge of the third segment and partly dorso-laterally in the caudal part of the fourth segment. The remainder passes dorsally and is united medially by a tendon to the other muscle of the pair.

Musculus obliquus anterior 4 (obl a_4 , Fig. 19, 20)

This muscle is only distinguished from the preceding muscles of the series in its origin. It arises dorso-medially on the fascia by which the first anterior oblique muscle is inserted (obl a_1 , Fig. 19). It passes ventrally, thence caudally, and laterally, and is inserted by tendons partly laterally on the caudal edge of the fourth segment and partly dorsally in the caudal part of the fifth segment.

Musculus obliquus anterior 5 (obl a_5 , Fig. 19, 20)

Arises on the median fascia of the second anterior oblique muscle (obl $a_2 f$, Fig. 19), and the fibres follow a similar course to that of the preceding muscle. Part is inserted by a tendon medio-laterally on the caudal edge of the fifth segment, and the remainder passes dorsally to be inserted by a tendon on the dorsal side of the sixth segment.

Musculus obliquus anterior 6 (obl a_6 , Fig. 19, 20)

Arises on the median fascia of the third oblique muscle, and follows a similar course to the preceding muscles. It is partly inserted with the fifth posterior oblique muscle (obl p_5 , Fig. 20), and the remainder is inserted with the fifth anterior oblique muscle (obl a_5 , Fig. 19, 20) on the dorso-lateral side of the sixth segment.

Musculus obliquus posterior 1 (obl p_1 , Fig. 20)

This muscle is somewhat complex. One branch arises on the same fascia as the first anterior oblique muscle (obl f , Fig. 20) dorsal and

medial to the latter. The two muscles of the pair tend to unite together by means of a thin tendinous band (obl $p_1 f$, Fig. 20) and are inserted on it. Another similar branch arises laterally on the first transverse muscle (obl $p_1 l$) and the fibres pass ventrally and medially to an insertion on the median fascia. The main part of this muscle arises partly with the first and third branches and partly on the median fascia (obl $p_1 f$, Fig. 20) dorsal to the remainder of the muscle. It passes caudally and laterally. At the lateral side it is joined by the first branch and the two are inserted by a tendon partly in the rostral and partly in the caudal part of the first segment.

(In *Astacus* this muscle is connected with the oblique thoracic band which is lacking in *Pandalus*, and *Homarus*. In *Homarus*, however, this first posterior oblique muscle is also lacking, according to Schmidt.)

Musculus obliquus posterior 2 (obl p_2 , F g. 19, 20)

This muscle also arises on the ventral side of the first abdominal transverse muscle but is not directly connected to it. At the lateral side of this transverse muscle there arises another muscle which passes around it to the dorsal side (obl $p_2 x$, Fig. 19) and ends dorso-medially in a flat tendon (obl $p_2 f$, Fig. 19). The second posterior oblique muscle (obl p_2 , Fig. 19, 20) has its origin on this tendon. It turns medially on the dorsal side, then passes to the ventral side, twisting around the transverse muscle. On the ventral side it passes caudally and laterally, and is inserted in the caudal part of the second segment by the same tendon as the second anterior oblique muscle.

Musculus obliquus posterior 3, 4 (obl p_3 , 4, Fig. 19, 20)

The third oblique posterior muscle has its origin on the oblique tendon which runs laterally from the mid-line, on the dorsal side of that muscle mass which is caused by a fusion of the transverse muscles ($tra_2 +_3$, Fig. 19). It follows a similar course to that of the second oblique posterior muscle, and is inserted by the same tendon as the third anterior oblique muscle laterally on the caudal edge of the third segment. The fourth posterior oblique muscle corresponds exactly to the third and is inserted with the fourth anterior oblique muscle laterally on the caudal edge of the fourth segment.

Musculus obliquus posterior 5 (obl p_5 , Fig. 19, 20)

The origin is similar to that of the two preceding muscles on the oblique fascia of the fourth muscle mass ($tra_4 +_5$, Fig. 19), and the fibres follow a similar course. However instead of being inserted with the fifth anterior oblique muscle it joins the sixth (obl a_6 , Fig. 20) and is

inserted with it laterally by a tendon on the ventro-caudal edge of the fifth segment.

There are no posterior oblique muscles corresponding to the sixth and seventh anterior oblique muscles.

Musculus flexor telsonis anterior (fl ta, Fig. 24)

This muscle has its origin latero-ventrally in a long thin tendon. It arises on that fascia by which the seventh oblique muscle is inserted on the protopodite of the uropod (obl a_7 s, Fig. 23). It is inserted by a broad surface dorso-medially near the proximal edge of the telson, which it moves ventrally.

Musculus flexor telsonis posterior (fl tp, Fig. 23, 24)

This muscle arises by the same tendon as the anterior flexor. It passes dorsally and is inserted by a broad surface dorso-medially posterior to the anterior flexor which it assists in function and greatly exceeds in strength.

Musculus flexor telsonis ventralis (fl tv, Fig. 23, 24)

This muscle, which is fairly large, has its origin in a broad surface on the fascia of the last oblique muscle (obl a_7 s, Fig. 23). It is inserted on the ventral surface of the telson by a fan-shaped tendon. It assists the other two flexors in moving the telson ventrally.

(This muscle does not occur in *Astacus*.)

Musculus dilator ani (d an, Fig. 23)

It arises on the dorsal side of the fascia of the last oblique muscle (obl a_7 s, Fig. 23) and is inserted medio-ventrally without tendinous structure by the side of the anus. By its contraction the anus is opened. It is opposed by the elasticity of the chitin around the anus.

Musculi dorsales profundi abdominis (dam dal, Fig. 21)

These muscles almost fill the space between the dorsal side of the transverse oblique muscles and the carapace. There are two parts, medial and lateral, to the muscle in each segment. Whereas in *Astacus* the medial part (dam, Fig. 21) is more or less continuous from one end of the abdomen to the other, merely giving off fibres in each segment, in *Pandalus* there is a much stronger indication of segmental arrangement, for the course of the fibres varies from segment to segment, and each intersegmental part is distinct from the next.

The medial branch of the first muscle in the series (dam_{1, 2}, Fig. 21) has its origin partly in the rostral part of the first abdominal segment and partly in a tendon at the end of the dorsal thoracic muscle. It is

inserted medially in the anterior part of the second segment. Seen from the ventral side the fibres pass in a medial as well as a posterior direction. The medial branch connecting the second and third abdominal segments ($dam_2, 3$, Fig. 21) arises medio-dorsally in the second segment close to the insertion of the first muscle in the series. It is inserted in a similar way to the first muscle in the rostral part of the third segment, the fibres, however, have a slightly more longitudinal course than in the first muscle. The medial part of the muscle joining the third and fourth segments ($dam_3, 4$, Fig. 21) is similar to the first two but varies in that the fibres twist around one another in a spiral, giving a more transverse appearance to their direction, as seen from the ventral side. The medial parts of the dorsal muscles running from the fourth to fifth ($dam_4, 5$, Fig. 21) and fifth to sixth segments ($dam_5, 6$, Fig. 21) respectively, are similar in origin and insertion to the preceding muscles but their fibres follow an almost completely longitudinal course. The last muscle of the series, that joining the sixth segment and the telson, ($dam t$, Fig. 21) has no lateral branch and is much smaller than the preceding muscles. It is a straight ribbon of fibres arising dorso-medially in the rostral part of the sixth segment and inserted dorso-medially on the rostral edge of the telson. (This last muscle is lacking in *Astacus*.)

The lateral branch of the first muscle ($dal_1 s$, Fig. 21) arises in the same way as the medial branch and close to it. It is inserted dorsally in the anterior part of the second segment lateral to the insertion of the median branch. The second and third lateral branches in the series ($dal_2, 3$, $dal_3, 4$, Fig. 21) are similar to the first. The fourth muscle ($dal_4, 5$, Fig. 21) merges much more with the medial portion, owing to the more longitudinal direction of the fibres in the latter. Its origin is slightly posterior to that of the medial part so that some of its fibres pass under those of the medial branch. The lateral branch joining the fifth and sixth segments is more complex than the preceding, having an anterior and a posterior part. The anterior part ($dal a_5, 6$, Fig. 21) arises lateral to the medial branch about the middle of the fifth segment and is inserted in the rostral part of the sixth segment. The posterior portion ($dal p_5, 6$, Fig. 21) has its origin in a few fibres just posterior to the origin of the anterior part, and then narrows to a thin tendon. To this tendon are attached two muscle branches, one of which is inserted laterally, the other medially, in the rostral part of the sixth segment posterior to the insertion of the anterior part.

The whole series of muscles extends the abdomen, thus acting as an antagonist to the ventral and oblique muscles. The twisting of the fibres gives an increased power of movement by a slight twining of the muscle about its long axis.

Musculi dorsales superficiales (ds_{2-7} , Fig. 21)

This is a series of weak muscles running down the dorsal side of the animal lateral to the stronger *musculi dorsales profundi*. They are not as strong as in *Astacus* and are not in two parts, as are those of *Astacus*, except in that joining the first and second abdominal segments (ds_2 , Fig. 21). In *Astacus*, also, the first muscle of the series unites the epimeral plate and the first segment of the abdomen, and is referred to as *musculus dorsalis superficialis* 1. This muscle is lacking in *Pandalus*, but, for the sake of homology, that muscle which joins the first and second segments is called *musculus dorsalis superficialis* 2. The first muscle, then, (ds_2 , Fig. 21) arises dorso-laterally in the caudal part of the first segment. Part of it is inserted on the anterior edge of the second segment, and part passes medially dorsal to the deeper dorsal muscles and is inserted in the anterior part of the second segment. The next muscle (ds_3 , Fig. 21) arises in the anterior part of the second segment, and passes in a medial direction to be inserted on the anterior edge of the third segment. The third, fourth, fifth and sixth muscles (ds_4 ds_5 ds_6 ds_7 , Fig. 21) each arise dorso-laterally in the caudal part of one segment and are inserted on the anterior edge of the next following segment.

These muscles assist the deeper dorsal muscles as extensors of the abdomen.

Musculi laterales abdominis

This is a series of very weak muscles running from segment to segment, and each consisting of a few fibres. They are inserted on the articulations of the abdominal segments and attached to the hypodermis. The first three are fairly distinct, though the third is much smaller than the first. The fourth muscle, that is the one between the fourth and fifth segments, is very small and it is doubtful if there is a fifth one at all.

The purpose of this series of muscles is very obscure. As they are attached directly to the joints they cannot produce any movement of the abdominal segments. In discussing *Astacus*, Schmidt suggests that they may have some significance in the process of moulting, but, failing this, they seem utterly useless.

B. The Muscles of the Appendages

The abdominal appendages are very much simpler and less modified than those of the thorax. The two joints of the protopodite are distinct in the pleopods, but fused in the uropods. The endopodite and exopodite are equally well developed, being broad lamellate rami in the uropods, while in the pleopods they are flexible and fringed with long natatory setae.

Corresponding to this lack of modification in the abdominal appendages, the musculature is comparatively simple. As would be expected considering differences in habits, these muscles are larger and stronger in *Pandalus* than in *Astacus*. Moreover, several new muscles have been developed in connection with the increased power of swimming, but these will be dealt with in detail below.

First to Fifth Pairs of Pleopods (Fig. 22)

The first five abdominal appendages have such a similar structure that a study of the third appendage can be applied to all.

In *Astacus* the first two pleopods of the male and especially the second, are very much modified and their muscles consequently altered. In *Pandalus* there is very little modification of these appendages and no essential difference in their muscles at all. Another variation occurs in the exopodite and endopodite which are segmented flagella in *Astacus*, but in *Pandalus* are unsegmented, flat, flexible rami. The endopodite has two segments, the exopodite only one.

Musculus remotor III pedis spurii (rem, Fig. 18, 22)

This muscle arises laterally on the tergum of the third abdominal somite by a broad surface, and is inserted somewhat diminished in size, on the posterior, proximal edge of the coxopodite (C, Fig. 22). It moves the latter backward about a transverse axis.

Musculus rotator dorsalis basipoditis III pedis spurii (rot d, Fig. 18, 22)

This muscle also arises laterally on the tergum anterior to the remotor, and is inserted on the anterior proximal edge of the basipodite. It is a little smaller than the remotor but similar to it in shape. It moves the basipodite outward and forward.

Musculus rotator ventralis basipoditis III pedis spurii (rot v, Fig. 22)

It arises medially on the sternum and is inserted medially in the basipodite. It is much weaker than the dorsal rotator, and moves the basipodite inward and forward. The two rotators can move together or separately and in connection with the remotor, produce a rotation of the protopodite. In this function they are also assisted by the adductor of the basipodite.

Musculus adductor basipoditis III pedis spurii (add b, Fig. 22)

It has its origin medio-caudally in the coxopodite and is inserted laterally in the proximal part of the basipodite. It moves the latter inward and slightly rotates it.

(This muscle does not occur in *Astacus*.)

Musculus reductor basipoditis III pedis spurii (red b, Fig. 22)

It arises on the caudal side of the coxopodite, near the insertion of the remotor, passes through the whole of the basipodite, and is inserted at the distal end on the caudal side by a broad surface. It contains no tendinous material. It moves the basipodite backward and assists the adductor of the exopodite.

Musculus productor basipoditis III pedis spurii (prod b, Fig. 22)

It arises by a tendon on the rostral side of the coxopodite, near the insertion of the dorsal rotator, passes through the whole of the basipodite and is inserted by a broad surface at the distal end on the anterior side. It moves the basipodite forward and assists the rotators as antagonists of the reductor.

(This muscle is not found in *Astacus*.)

Musculus adductor exopoditis III pedis spurii (add ex, Fig. 22)

It arises without a tendon medially in the proximal part of the basipodite, and passes posterior to the other muscles in the joint, to be inserted medially on the proximal edge of the exopodite. It moves the exopodite inward.

Musculus abductor exopoditis III pedis spurii (abd ex, Fig. 22)

This muscle arises laterally in the proximal part of the basipodite, and is inserted laterally on the proximal edge of the exopodite. It has no tendinous structure. It moves the exopodite, and with it the closely attached endopodite, outward.

Musculus adductor endopoditis III pedis spurii (add end, Fig. 22)

It arises medially in the distal part of the basipodite by a tendon, and is inserted without a tendon medially on the anterior side of the first segment of the endopodite. It moves the endopodite inward.

(The above three muscles differ considerably in proportion in *Astacus*. Moreover in the latter there is no separate adductor of the exopodite, its place being taken by the large adductor of the endopodite which moves both branches together. There is, however, a small abductor of the endopodite, which is absent in *Pandalus*.)

Musculus flagellaris endopoditis III pedis spurii (flag end, Fig. 22)

The muscle arises medially in the proximal part of the endopodite, close to the insertion of the adductor, and is attached throughout the flat endopodite by fibres given off at intervals. It permits great mobility of the endopodite.

Musculus flagellaris exopoditis III pedis spurii (flag ex, Fig. 22)

It arises medially in the first segment of the exopodite and gives off fibres to be inserted throughout the exopodite. Its action is similar to that of the flagellar muscles in the exopodite.

The Uropods (Figs. 23, 24)

In these appendages the exopodite and endopodite attain a great size, although the appendage shows a normal biramous arrangement. The musculature is much more complicated than in the pleopods. The coxopodite and basipodite are immovably fused together and the whole protopodite is united to the body by a thin chitinous ring which permits great freedom of movement.

In contrast to the other appendages, especially those of the cephalothorax Schmidt notes that the musculature of the exopodite is strongly developed, while the endopodite has only one weak muscle.

Musculus remotor lateralis protopoditis uropodos (rem l, Fig. 24)

The muscle arises dorso-laterally about the middle of the sixth abdominal segment and is inserted dorso-laterally on the proximal edge of the protopodite by a short tendon. It moves the protopodite backward, or dorsally, and outward.

Musculus remotor medialis protopoditis uropodos (rem m, Fig. 24)

It arises dorso-medially near the middle of the sixth segment and is inserted dorso-laterally on the protopodite just medial to the insertion of the lateral remotor. It assists the latter in function and greatly exceeds it in strength.

Musculus rotator protopoditis uropodos (rot, Fig. 24)

It has its origin in a broad surface dorso-medially in the anterior part of the sixth abdominal segment. It has a leaf-shaped form and narrows considerably toward its insertion. The greater part of it is inserted ventro-laterally on the proximal edge of the protopodite by a tendon. Two small branches are inserted by tendons slightly medial to the main insertion and close to the insertions of two of the branches of the telso-uropod muscle. This muscle moves the uropod ventrally and outward.

Musculus telso-uropedalis (tua tul tup, Fig. 23, 24)

This muscle arises dorso-laterally near the anterior edge of the telson by a short tendon. It has a cylindrical form but branches towards its insertion. One branch (tua, Fig. 23) divides again and is inserted by two short tendons at the insertion of the rotator of the protopodite.

A second branch (tul, Fig. 23, 24) is inserted dorso-laterally on the proximal edge of the protopodite by a short tendon. The third branch (tup, Fig. 23, 24) is inserted ventro-medially in the proximal part of the protopodite. The whole muscle is comparatively weak, being little more than a few fibres and a strong tendon. Its function is to pull the protopodite inward and dorsally, thereby partly assisting and partly opposing the remotors.

Musculus abductor exopoditis lateralis uropodos (abd ex l, Fig. 23, 24)

This muscle is peculiar in consisting of two fairly large masses of fibres joined by a short thin cylindrical tendon. It arises dorso-laterally by a broad surface and narrows to the thin tendon aforementioned at the joint between protopodite and exopodite. In the exopodite it widens again to a mass of muscle fibres which is inserted by a broad surface in the first segment, partly dorsally and partly ventrally. It moves the exopodite, and, with it, the endopodite outward, thus opening the tail fan.

(It is probable that this muscle represents the three abductors found in *Asiacus*, all fused together.)

Musculus adductor exopoditis anterior uropodos (add ex a, Fig. 23, 24)

It arises medially by a broad surface in the protopodite. It passes laterally and is inserted by a broad surface dorsally in the middle of the first segment of the exopodite. It pulls the exopodite inward.

Musculus adductor exopoditis posterior uropodos (add ex p, Fig. 23, 24)

It arises by a short tendon ventrally in the distal part of the protopodite, and is inserted by a broad surface medially in the first segment of the exopodite. It assists the anterior adductor in opposing the abductor of the exopodite.

Musculus productor exopoditis uropodos (prod ex, Fig. 23, 24)

This muscle arises by a broad surface dorsally in the proximal part of the protopodite, and is inserted by a thin tendon ventrally near the proximal edge of the exopodite. It moves the latter in a ventral direction.

Musculus reductor exopoditis uropodos (red ex, Fig. 23, 24)

This muscle is weaker than its antagonist, the productor. It has its origin in a broad surface near that of the productor and passes slightly laterally to be inserted without a tendon dorsally, near the proximal edge of the exopodite.

Musculus adductor endopoditis uropodos (add end, Fig. 23, 24)

It arises dorso-medially in the protopodite without tendons, and is inserted ventro-medially on the proximal edge of the endopodite by a small tendon. It produces an inward motion of the endopodite.

LITERATURE

- Gerstaecker, A. and Ortmann, A. E. 1901. Decapoda. Brönn's Klassen und Ordnungen des Tierreiches. V Bd. 2 Abt.
- Huxley, T. H. 1879. The Crayfish. An Introduction to the Study of Zoology.
- Lankester, R. 1909. Crustacea. A Treatise of Zoology, Part VII.
- Lemoine, M. Victoire. 1879. Recherches pour servir à l'histoire des systèmes nerveux, musculaire, et glandulaire de l'écrevisse. Ann. des Sci. Nat., Zool., V. Ser. Paris.
- Milne-Edwards, M. 1834. Histoire naturelle des Crustacés, Bd. I u. Atlas. Paris.
- Mocquard, F. 1883. Recherches anatomiques sur l'estomac des crustacés podophtalmiques. Ann. des Sci. Nat., Zool., T. XVI. Paris.
- Rathbun, Mary J. 1910. Decapod Crustaceans of the Northwest Coast of North America. Harriman Alaska Series. Smith. Inst., Vol. X.
- Schmidt, H. 1915. Die Muskulatur von *Astacus fluviatilis* (*Potamobius astacus* L.). Zeit. für Wissen. Zool.,
- Suckow, Fr. Wilk. Ludwig. 1818. Anatomisch-Physiologische Untersuchungen der Insekten und Krustentier, Bd. I, Heft 1. Heidelberg.

DESCRIPTION OF PLATES

PLATE I

- Fig. 1.** A dissection of the head and thorax from the left side. The carapace, epimeral plate, the muscles of the thoracic appendages, and the attractor epimeralis have been removed.
add p mand adductor posterior mandibulae; *depr (prom, rem) II Ant* depressor (promotor, remotor) II antennae; *dth (dthm, dthl)* dorsal thoraco-abdominal muscle (medial branch, lateral branch); *dva (1, 4)* anterior dorso-ventral muscle; *lth (lthm lthl)* lateral thoraco-abdominal muscle (medial branch, lateral branch); *tha (tham thal)* anterior thoracic muscle (medial branch, lateral branch).
- Fig. 2.** The interior of the right side of the head and thorax.
add p mand adductor posterior mandibulae; *depr II Ant* depressor II antennae; *dth (dthm, dthl)* dorsal thoraco-abdominal muscle (medial branch, lateral branch); *dva (1, 2)* anterior dorso-ventral muscle; *lthm* medial branch of lateral thoraco-abdominal muscle; *tha (tham)* anterior thoracic muscle (medial branch); *vsth (4:3-7:8)* superficial ventral thoracic muscles (2:3-7:8).
- Fig. 3.** Dorsal view of head and thorax with carapace removed. On the right side the lateral thoracic muscle has also been removed.
depr II Ant depressor II antennae; *dth (dthm, dthl)* dorsal thoraco-abdominal muscle (medial branch, lateral branch); *lth (m and l)* lateral thoraco-abdominal muscle (medial branch and lateral branch); *tha* anterior thoracic muscle.
- Fig. 4.** Dorsal view of thorax with lateral and dorsal thoracic muscles removed and the sides somewhat stretched apart.
depr II Ant depressor II antennae; *tha (tham, thal)* anterior thoracic muscle (medial branch, lateral branch).
- Fig. 5.** Dorsal view of thorax with lateral, dorsal and anterior thoracic muscles removed to show the superficial ventral muscles, and the muscles moving the thoracic appendages. The sides are somewhat stretched apart.
attr ep attractor epimeralis; *depr (prom)* depressor (promotor) of pereopod; *dvp* posterior dorso-ventral muscle; *prom II Ant* promotor II antennae; *vsth (2:3-7:8)* superficial ventral thoracic muscles; *vstha* superficial ventral thoraco-abdominal muscles.

PLATE II

- Fig. 6.** Dissection of the eyes from the dorsal side.
abd abductor; *add* adductor; *attr* attractor; *oba* oculi basilis anterior; *obp* oculi basilis posterior; *rd* oculi retractor dorsalis; *rl* oculi retractor lateralis; *rm* oculi retractor medialis; *rv* oculi retractor ventralis.
- Fig. 7.** The first antennae dissected from the dorsal side.
abd (a and b) abductor (a and b); *abd₃* abductor of third segment; *add* adductor; *prod (red)₂ & ₃* productors (reducers) of second and third segments; *red₄* reductor of flagellum; *rem (a & b)* remotor (a and b); *prom* promotor.
- Fig. 8.** Dissection of the second antennae from the dorsal side.
carp M. carpopoditis; *depr (a, b, c)* depressor (a, b, c); *ex abd* abductor exopoditis; *ex add (a, b)* adductor exopoditis (a, b); *ext₁ (flex₁)* extensor (flexor) dactylopoditis; *lev* levator; *mer M.* meropoditis; *prom* promotor; *prop M.* propoditis; *red i* reductor ischiopoditis; *rem* remotor.

- Fig. 9. The mandibles from the dorsal side, showing also the anterior fascia (*fa*), the anterior dorso-ventral muscles (*dva*) and the ventral head muscles (*vc*). On the right side the labrum has been cut away to expose the incisor process and the palp.
abd abductor; *add* (*a, l, p*) adductor (anterior, lateralis, posterior); *ext p* (*flex p*) extensor (flexor) palpi; *x, xx* points of articulation.
- Fig. 10. Dissection of the first maxillae from the dorsal side.
abd abductor; *add end* adductor endopoditis; *add l (m) c* adductor lateralis (medialis) coxopoditis; *B* basipodite; *C* coxopodite; *depr* depressor; *En* endopodite; *lev* levator; *prom* promotor; *rem a (b)* remotor a (b).
- Fig. 11. Dissection of the second maxillae from the dorsal side.
add c adductor coxopoditis; *add end* adductor endopoditis; *depr* depressor; *flex scg inf (sup)* flexor scaphognathitis inferior (superior); *prom* promotor; *rem* remotor; *r (a, b, d, e, f, g)* respiratorius (primus, secundus, quartus, quintus, sextus, septimus).

PLATE III

- Fig. 12. Dissection of the first maxillipeds from the dorsal or anterior side.
abd ex abductor exopoditis; *abd fl* abductor flagelli exopoditis; *add end (a & b)* adductor endopoditis (a & b); *add ex* adductor exopoditis; *attr ep (a & b)* attractor epipoditis (a & b); *B* basipodite; *C* coxopodite; *depr* depressor; *En* endopodite; *Ep* epipodite; *Ex* exopodite; *flag M.* flagellaris; *lev* levator; *prom l (m)* promotor lateralis (medialis); *rem* remotor.
- Fig. 13. Dissection of the second maxillipeds from the dorsal or anterior side.
abd₁ (add₁) abductor (adductor) carpopoditis; *add ex* adductor exopoditis; *attr ep* attractor epipoditis; *depr (a & b)* depressor (a & b); *flag M.* flagellaris; *lev (a & b)* levator (a & b); *prom* promotor; *rem* remotor; *prod₂ (red₂)* productor (reductor) meropoditis; *prod₄ (red₄)* productor (reductor) propoditis; *prod₅ (red₅)* productor (reductor) dactylopropoditis.
- Fig. 14. Dissection of the third maxillipeds from the anterior side.
attr mast attractor mastigobranchia; *depr* depressor; *B* basipodite; *C* coxopodite; *K* carpopodite; *lev (a, b, c)* levator a, b, c); *I* ischiopodite; *prom* promotor; *rem* remotor; *prod₃ (red₃)* productor (reductor) carpopoditis; *ext₄ (flex₄)* extensor (flexor) propoditis.

PLATE IV

- Fig. 15. Dissection of the first pereopods from the anterior side.
abd₁ (add₁) abductor (adductor) carpopoditis; *attr mast* attractor mastigobranchia; *C* coxopodite; *B* basipodite; *depr (a, a₁, b)* depressor (a, a₁, b); *D* dactylopropodite; *I* ischiopodite; *K* carpopodite; *lev (a, b, c)* levator (a, b, c); *prom* promotor; *rem* remotor; *red₁* reductor ischiopoditis; *red₂* reductor meropoditis; *red₄ (prod₄)* reductor (productor) propoditis.
- Fig. 16. Dissection of the second pereopods from the anterior side. Only the right leg is shown entirely.
abd₁ (add₁) abductor (adductor) carpopoditis; *abd₂ (add₂)* abductor (adductor) dactylopropoditis; *attr mast* attractor mastigobranchia; *B* basipodite; *C* coxopodite; *D* dactylopropodite; *depr (a, a₁, b)* depressor (a, a₁, b); *ext (a, b)* carp extensor (a, b) carpopoditis; *ext (a, b) prop* extensor (a, b) propoditis; *flex (a, b) carp* flexor (a, b) carpopoditis; *flex (a, b) prop* flexor (a, b) pro-

poditis; *I* ischiopodite; *lev* (*a, b, c*) levator (*a, b, c*); *M* meropodite; *prom* promotor; *rem* remotor; *red₁* reductor ischiopoditis; *red₂* reductor meropoditis.

PLATE V

Fig. 17. Dissection of the third pereopods from the anterior side.

abd₂ (*add₂*) abductor (adductor) carpopoditis; *abd₃* (*add₃*) abductor (adductor) dactylopoditis; *attr mast* attractor mastigobranchia; *B* basipodite; *C* coxopodite; *D* dactylopodite; *depr* (*a, a₁, a₂, b*) depressor (*a, a₁, a₂, b*); *K* carpopodite; *I* ischiopodite; *lev* (*a, b, c*) levator (*a, b, c*); *M* meropodite; *P* propodite; *prom* promotor; *rem* remotor; *red₁* reductor ischiopoditis; *red₂* reductor meropoditis; *red₃* (*proda*) reductor (productor) propoditis.

PLATE VI

Fig. 18. Dissection of the abdomen from the dorsal side. All muscles have been removed except the ventral superficial series, and those moving the pleopods; *rem* remotor of pleopod; *rot d* dorsal rotator of pleopod; *v s a* (*1, 2; 2, 3; 3, 4, 4, 5; 5, 6*). *M. ventrales superficiales abdominis* (*1, 2; 2, 3; 3, 4; 4, 5; 5, 6*).

Fig. 19. Dissection of the abdomen from the dorsal side. The dorsal muscles and those moving the uropods have been removed.

fl tv flexor telsonis ventralis; *obl* (*1, 4, 3, 4, 5+6, 7*) *M. obliquus anterior* (*1, 2, 3, 4, 5+6, 7*); *obla* (*1-4*) *f* *M. obliquus anterior* (*1-4*), dorsomedian fascia; *obl p₂ f* tendon from which arises *M. obliquus posterior 2*; *obl p₂* *M. obliquus posterior 2*; *obl p₂ x* muscle which gives rise to *M. obliquus posterior 2*; *tha* anterior thoracic muscle; *tha, f* tendon by which the anterior thoracic muscle is inserted; *tra₁* (*a*); *M. transversus abdominis 1* (*6*); *tra* (*2+3, 3+4, 4+5*) dorsal fusion of *tra₂* with *tra₃*, etc.; *tra₁ ds* insertion of *M. transversus abdominis 3*.

PLATE VII

Fig. 20. Dissection of the abdomen from the ventral side. The superficial ventral muscles have been removed.

obla (*1-7*) *M. obliqui anteriores* (*1-7*); *obl f* fascia by which the anterior thoracic muscle is inserted; *obl p* (*1-5*) *M. obliqui posteriores*; *obl p₁ f* median fascia of *M. obliquus posterior 1*; *obl p₁ U* origin of *M. obliquus posterior 1*; *tra* (*1-6*) *M. transversi abdominis*; *tra₁ a* ventral part of *M. transversus abdominis 1*; *tra₁ af* lateral fascia from which *M. transversus abdominis* arises; *tra₁ s* dorso-lateral insertion of *M. transversus abdominis 1*; *tra₁ ds* insertion of *M. transversus abdominis 2*.

Fig. 21. Dissection of the abdomen from the ventral side. All ventral muscles have been removed.

dal (*1, 2-4, 5*) *M. dorsales profundi abdominis*, lateral part; *dam* (*1, 2-5, 6*) *M. dorsales profundi abdominis*, medial part; *dal a* *5, 6* anterior branch of lateral part of *M. dorsalis profundus 5, 6*; *dal p* *5, 6* posterior branch of lateral part of *M. dorsalis profundus 5, 6*; *dam t* medial part of *M. dorsalis profundus* joining sixth segment and telson; *ds* (*1-7*) *M. dorsales superficiales*.

PLATE VIII

Fig. 22. Dissection of the third pair of pleopods from the anterior side.

abd ex abductor exopoditis; *add b* adductor basipoditis; *add end* adductor endopoditis; *add ex* adductor exopoditis; *flag end* M. flagellaris endopoditis; *flag ex* M. flagellaris exopoditis; *prod* productor; *red* reductor; *rem* remotor; *rot d* dorsal rotator; *rot v* ventral rotator.

Fig. 23. Dissection of uropods, telson and sixth segment of abdomen from the ventral side. Part of the muscles have been removed on the left.

abd ex l abductor of exopodite; *add end* adductor of endopodite; *add ex a* anterior adductor of exopodite; *add ex p* posterior adductor of exopodite; *fl tp* posterior flexor of telson; *fl tv* ventral flexor of telson; *dan* dilator of anus; *obl a₆* sixth anterior oblique muscle; *obl a₇* tendon by which the seventh anterior oblique muscle is inserted; *prod ex* M. productor exopoditis; *red ex* M. reductor exopoditis; *tul (tup)* M. telso-uropedalis, lateral branch (posterior branch).

Fig. 24. Dissection of the uropods, telson and sixth segment of abdomen from the dorsal side. On the right the remotors and all muscles in the uropod except M. telso-uropedalis have been removed. On the left M. telso-uropedalis has been removed.

abd ex l M. abductor exopoditis; *add end* M. adductor endopoditis; *add ex a* (*add ex p*) adductor exopoditis anterior (posterior); *fl ta* (*fl tp*, *fl tv*) M. flexor telsonis anterior (posterior, ventralis); *prod ex* M. productor exopoditis; *red ex* M. reductor exopoditis; *rem m* (*rem l*) M. remotor medialis (lateralis); *rot* rotator; *tua* (*tul*, *tup*) M. telso-uropedalis anterior (lateralis, posterior).

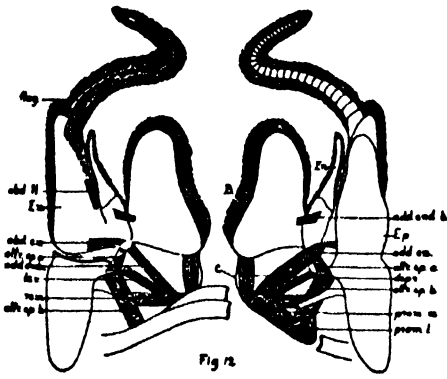

Fig 12

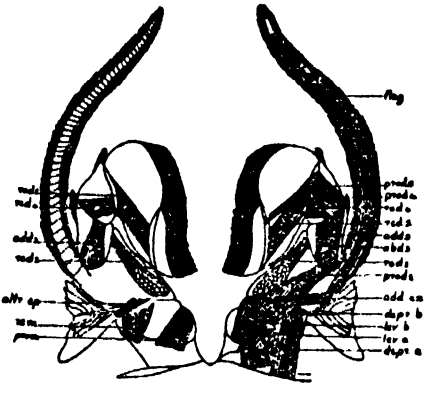

Fig. 13

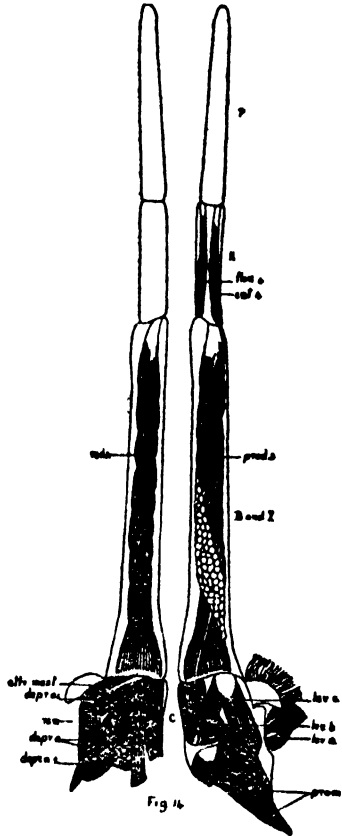
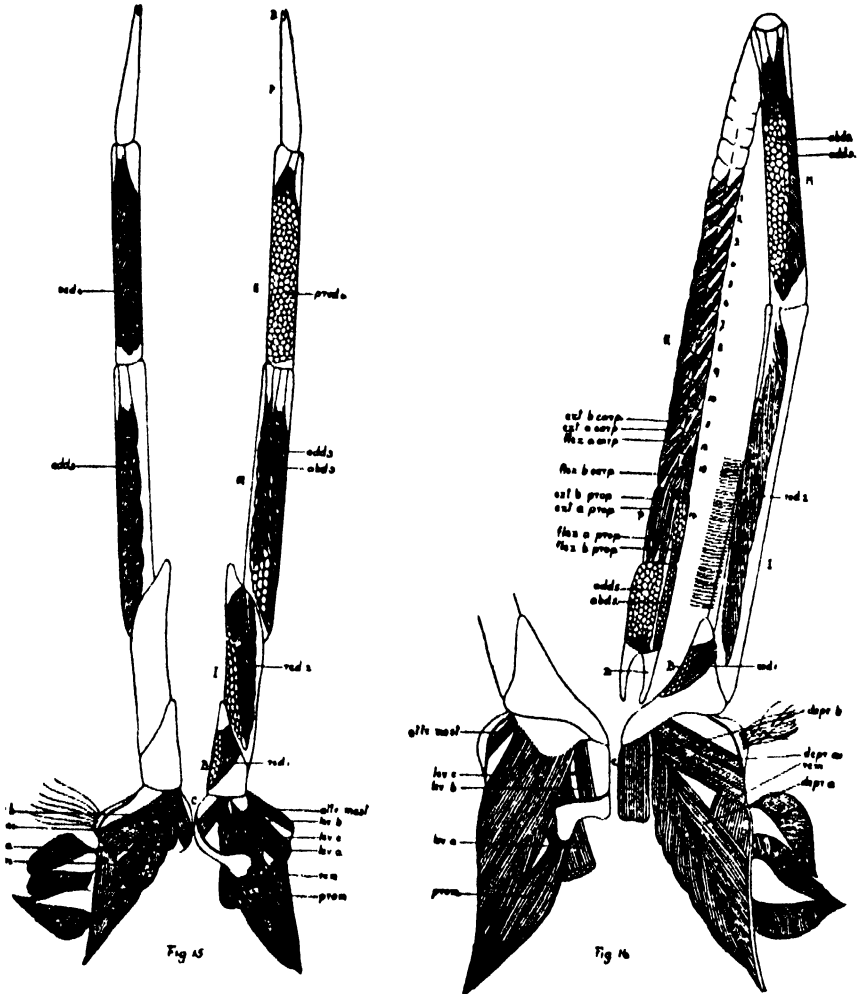
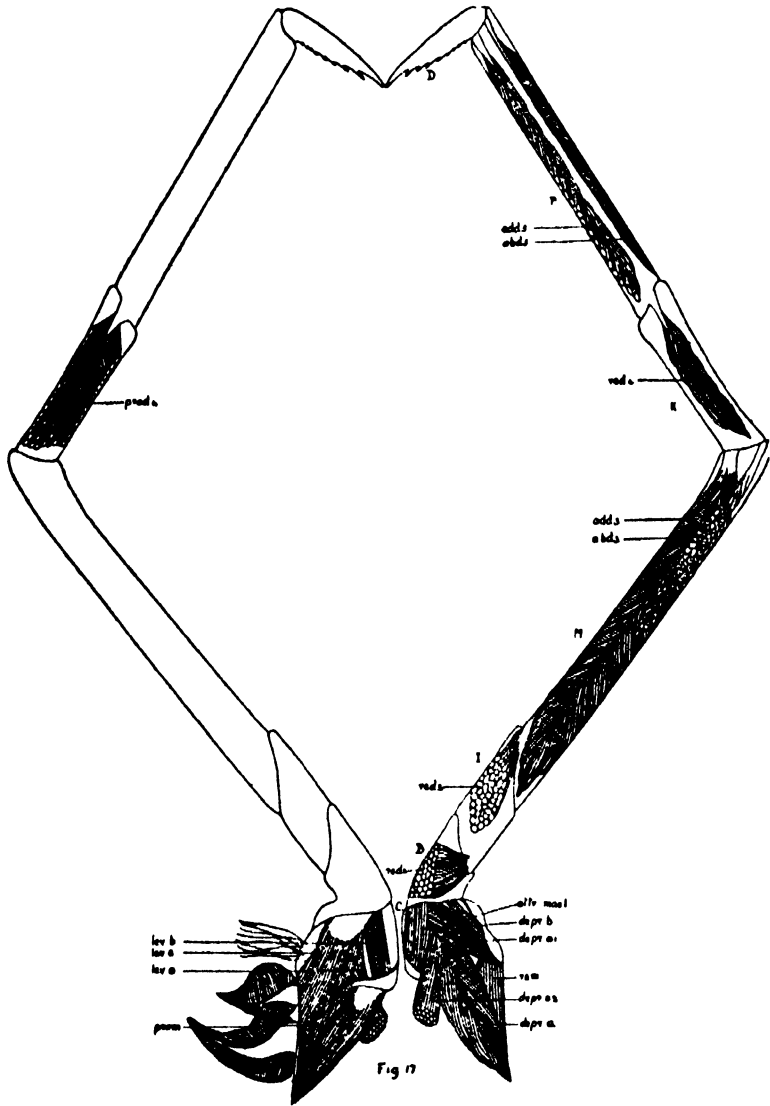

Fig 14

Berkeley on the Musculature of Pandalus



Berkeley on the Musculature of *Pandalus*



Berkeley on the Musculature of Pandulus

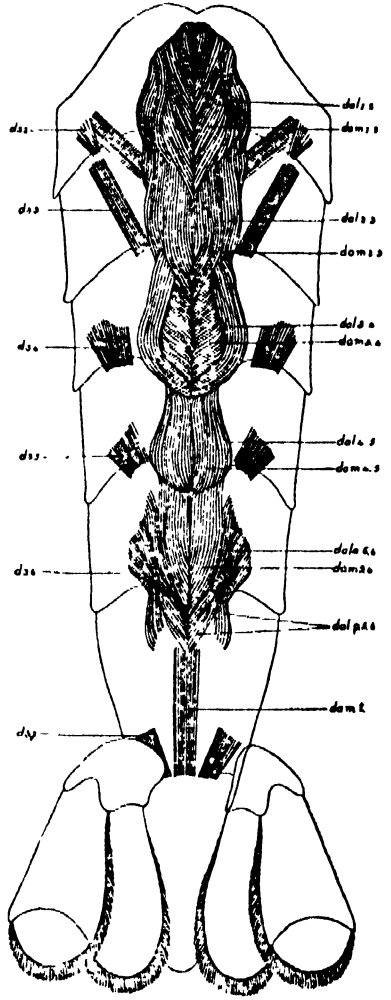
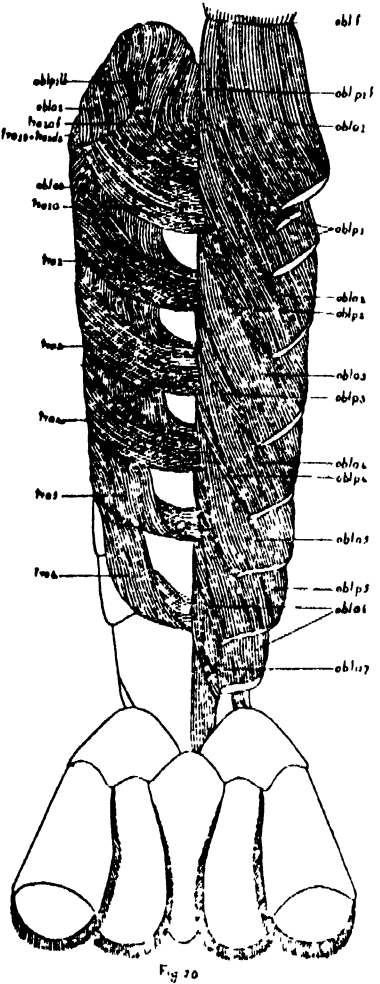

Berkeley on the Musculature of *Pandulus*

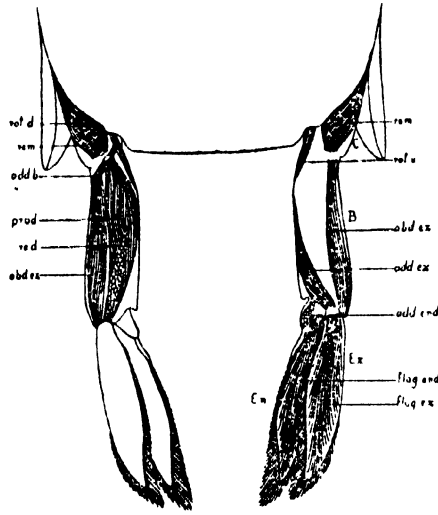

Fig 22

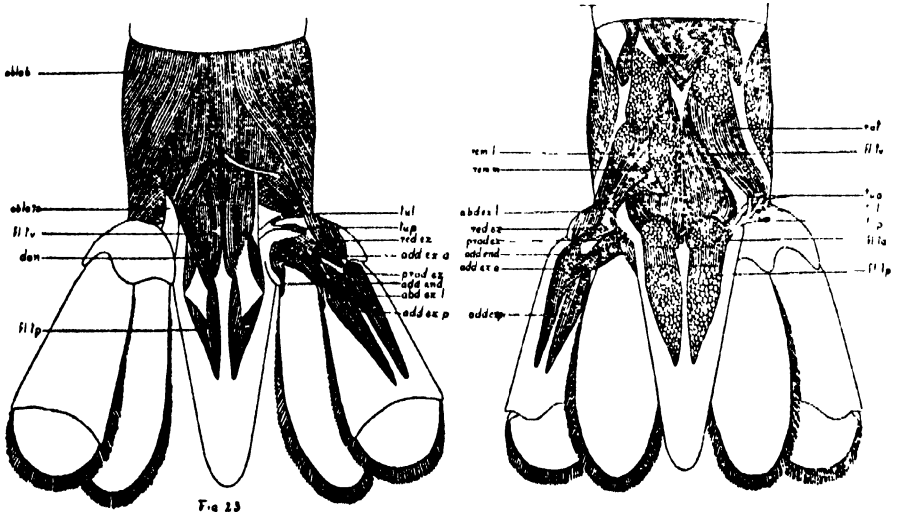

Fig 23

Fig 24

Berkeley on the Musculature of Pandalus

A FAUNAL INVESTIGATION OF THE LAKE NIPIGON REGION, ONTARIO¹

By J. R. DYMOND, L. L. SNYDER and E. B. S. LOGIER

GENERAL INTRODUCTION

Lake Nipigon lies within the Laurentian area of northwestern Ontario, about fifty miles north of Lake Superior. The lake itself occupies the lower portion of a basin-like depression most or all of which at one time constituted a northern bay of glacial Lake Algonquin.

The present water level of the lake is 852 feet above sea level or 250 feet above Lake Superior. It is the largest of the inland lakes of Ontario having an area of 1769 square miles. A characteristic feature is the numerous islands, many of which are quite large. With the exception of the mere rocky projections, these islands are wooded and resemble the elevations of the mainland.

The topography of the surrounding region is much rougher than that of the typical Archaean formation as a result of extensive flows of diabase which occurred at some time in its geological history. The region is characterised by numerous elevations of crystalline rock with intervening valleys occupied by bogs and lakes. These depressions drain from one to another by means of streams usually swift and with numerous falls and rapids in their courses.

The forest of the region is dense and composed principally of mixed stands. Variation in the type occurs somewhat according to the elevation, the high, dry hill-tops frequently supporting stunted and scattered jack pine while down the slopes grow aspen poplar, balsam fir, white spruce, paper birch, and balsam poplar. In some places the deciduous trees predominate over the coniferous and in other places this condition is reversed. Black spruce is sometimes found on high ground but it is generally confined to the lower, boggy areas. White cedar grows in some of the moist situations especially along stream courses and an occasional black ash is also to be found there. Tamarack occurs in many of the bogs but the trees are for the most part quite small. Mountain ash, white pine and red pine are rather rare but may occasionally be found. The principal shrubby trees of the forest are speckled alder

¹Contribution from the Royal Ontario Museum of Zoology, Toronto.

and mountain maple, the former bordering many of the lakes or covering the bottoms of damp basins between elevations, and the latter generally distributed over the floor of the mixed forest.

The climate of the Lake Nipigon region may be judged from the following data supplied by the Meteorological Service of Canada. In January the mean daily maximum varies from 8° to 12° F., and the mean daily minimum from -10° to -14° F. In July the lake is crossed by the isotherm of 74° mean maximum temperature while the isotherm of 32° F. mean annual temperature touches the north end of the lake. The precipitation is from 22 to 25 inches annually. The frost-free period varies in length from sixty to eighty days. Ice usually leaves the lake between the first and fifteenth of May and usually does not form sufficiently to close navigation until late in December. Surface temperatures (centigrade) of the water of the open lake during the summer months are recorded by Clemens (1923, 1924*a*, 1924*b*) as follows:

	1921			1922			1923		
Date	June 17	July 9	Aug. 29	June 27	July 20	Aug. 17	July 11	Aug. 15	Sept. 14
Temp.	12 5	22 0	17 1	10 3	18 2	17 6	15 3	14 5	11 3 ¹

The Canadian National Railway touches the southern end of Lake Nipigon at Macdiarmid and Orient Bay station while the old National Transcontinental Railway (now Canadian National) passes within a few miles of its northern end. The Canadian Pacific Railway comes within thirty-five miles of the south end of the lake at the town of Nipigon.

The region surrounding the lake is included in the Nipigon Forest Reserve and is still in its primitive condition although lumbering rights have recently been issued for certain areas within the reserve. The railways and such settlements as the fishing village of Macdiarmid, the Canadian National Railway's tourist lodge at Orient Bay station, the Hudson Bay Company's Post (Nipigon House) and a few small Indian settlements have not altered the primeval conditions generally.

Since 1917 the lake has been open to commercial fishing and now supports a thriving fishing industry, several steam tugs and gasoline boats being thus engaged. The district has been the centre of a large fur trade since the Hudson Bay Company established its post in 1791. The Lake Nipigon region is known particularly for its speckled trout

¹During the end of August and the beginning of September 1923 a number of rather violent storms mixed the waters of the lake so thoroughly as to lower the surface temperature and raise that of the lower depths.

which here reach a very large size. Sportsmen from all over the continent visit the waters of the Nipigon river to angle for the famous "Nipigon trout".

Previous Work

While Agassiz did not get nearer than the north shore of Lake Superior, his report (1850) was one of the earliest contributions to our knowledge of the geology, fauna and flora of this general region. Atkinson (1894) published a list of birds observed at Port Arthur and more recently Saunders (1922a, 1922b) has recorded observations made at Rossport.

The more immediate vicinity of Lake Nipigon has received rather thorough geological study; Bell, McInnes, Dowling, Parks, Coleman and Wilson have all contributed. The results of these studies have been summarized in Wilson's report (1910). Wilson, in connection with his geological work, published lists of trees, fishes, amphibians, reptiles, birds and mammals. Other studies of the fauna and flora of the immediate vicinity of Lake Nipigon have been made by Miller (1897), Jennings (1915, 1918a, 1918b, 1920), Koelz (1923), Clemens (1923, 1924a, 1924b), Adamstone (1922, 1924), Walker (1909, 1924), Moore (1924), and Dymond (1926).

Life Zone and Faunal Area

Although a part of the north shore of Lake Superior was considered by Miller (1897) as lying within the limits of the Hudsonian zone he was not able to ascertain whether this was an isolated area or was continuous with the main transcontinental Hudsonian belt on the north. Recent maps demarcating the life zones of North America do not include the section north of Lake Superior within the Hudsonian zone and quite properly include the Lake Nipigon region within the Algonquin, or forested area of the Canadian zone. Perhaps the best treatment of the faunal areas and life zones of Canada is that of Klugh and McDougall (1924). (The lines limiting the zones and faunal areas on their maps were drawn from meteorological data.) The results of the faunal investigations reported in the accompanying papers are in accord with their views.

The plant life of the region is quite characteristic of the Algonquin area of the Canadian zone and the principal trees of the forest such as balsam fir (*Abies balsamea*), white spruce (*Picea canadensis*), black spruce (*Picea mariana*), paper birch (*Betula alba*), and aspen poplar (*Populus tremuloides*) are reliable indicators.

Among the mammal records included in the accompanying report forms of the following species may be considered as characteristic of

the Algonquin area of the Canadian zone,—moose (*Alces americana*), Canada lynx (*Lynx canadensis*), varying hare (*Lepus americanus*) and woodland jumping mouse (*Napaeozapus insignis*).

Among the birds the following are some of the more characteristic species of the Algonquin faunal area: white-throated sparrow (*Zonotrichia albicollis*), magnolia warbler (*Dendroica magnolia*), Tennessee warbler (*Vermivora peregrina*), bay-breasted warbler (*Dendroica castanea*), arctic three-toed woodpecker (*Picoides arcticus*), Canada jay (*Perisoreus canadensis*), slate-colored junco (*Junco hyemalis*) and olive-backed thrush (*Hylocichla ustulata swainsoni*).

The following insects may be mentioned as characteristic,—butterflies: *Eurymus interior* Scudd., *Oeneis macounii* Edw., *Oeneis jutta* Hbn., *Carterocephalus palaemon* Pall., and *Pamphila manitoba* Scudd.; grasshoppers: *Circolettix verruculatus* Kirby, *Podisma glacialis canadensis* E. Walk., *Melanoplus islandicus* Blatchley, and *M. dodgei huroni* Blatchley; dragonflies: *Coenagrion interrogatum* Selys, *Ophiogomphus colubrinus* Selys, *O. anomalus* Harvey, *Aeshna subarctica* E. Walk., *A. interrupta interrupta* E. Walk., *Somatochlora walshii* Scudd., and *S. minor* Calvert.

Acknowledgements

During the prosecution of the work reported herein valuable assistance was received from the staff of the Fisheries Research Laboratory, Department of Biology, University of Toronto who were engaged in fisheries studies on the lake during the summer 1921 to 1924. Appreciation should also be expressed to numerous residents of the area who contributed in many ways to our faunal studies and whose courtesy and consideration made our stay a pleasant one.

J. R. D. L. L. S.

LITERATURE CITED

- Adamstone, F. B. 1922. Myxomycetes of the Lake Nipigon district. *Can. Field-Naturalist*, **36**: 129-131.
- Adamstone, F. B. 1924. The distribution and economic importance of the bottom fauna of Lake Nipigon. *Univ. of Toronto Studies: Biol. Series, Pub. Ont. Fisheries Research Lab., No. 24.*
- Agassiz, L. 1850. *Lake Superior, its physical character, vegetation and animals (with narrative by J. F. Cabot)*, Boston.
- Atkinson, G. E. 1894. A summer's collecting and observations at Port Arthur, Ontario. *Biol. Rev. Ont.*, **1**: 94-101.
- Clemens, W. A. 1923. The limnology of Lake Nipigon. *Univ. of Toronto Studies: Biol. Series, Pub. Ont. Fisheries Research Lab., No. 11.*

- Clemens, W. A. 1924a. The limnology of Lake Nipigon in 1922. Univ. of Toronto Studies: Biol. Series, Pub. Ont. Fisheries Research Lab., No. 17.
- Clemens, W. A. 1924b. The limnology of Lake Nipigon in 1923. Univ. of Toronto Studies: Biol. Series, Pub. Ont. Fisheries Research Lab., No. 22.
- Dymond, J. R. 1926. The fishes of Lake Nipigon. Univ. of Toronto Studies: Biol. Series, Pub. Ont. Fisheries Research Lab., No. 27.
- Jennings, O. E. 1915. Notes on the pteridophytes of northwestern Ontario. *Am. Fern Journ.*, **5**: 33-39.
- Jennings, O. E. 1918a. An annotated list of the pteridophytes of northwestern Ontario. *Am. Fern Journ.*, **8**: 38-50 and 76-88.
- Jennings, O. E. 1918b. Notes on the mosses of northwestern Ontario. *The Bryologist*, **21**: 69-76.
- Jennings, O. E. 1920. New or noteworthy plants from northwestern Ontario. *Journ. Wash. Acad. of Science*, **10**: 453-460.
- Klugh, A. B. and McDougall, E. G. 1924. The faunal areas of Canada. *Handbook of Canada*, pp. 195-206. University of Toronto Press.
- Koelz, W. 1923. Some recent records from the Lake Superior region, Ontario. *Can. Field-Naturalist*, **37**: 118.
- Miller, G. S. Jr. 1897. Notes on the mammals of Ontario. *Proc. Bost. Soc. Nat. Hist.*, **28**: 1-44.
- Moore, J. P. 1924. The leeches (Hirudinea) of Lake Nipigon. Univ. of Toronto Studies: Biol. Series, Pub. Ont. Fisheries Research Lab., No. 23.
- Saunders, W. E. 1922a. Occurrence of the red-throated loon at Rossport, Ontario. *Can. Field-Naturalist*, **36**: 137.
- Saunders, W. E. 1922b. Occurrence of the rock vole at Rossport, Ontario. *Can. Field-Naturalist*, **36**: 138.
- Walker, E. M. 1909. On the Orthoptera of northern Ontario. *Can. Ent.*, **42**: 137-144; 173-178; 205-212.
- Walker, E. M. 1924. The Odonata of the Thunder Bay District, Ontario. *Can. Ent.*, **56**: 182-189.
- Wilson, A. W. G. 1910. Geology of the Nipigon basin, Ontario. *Memoir No. 1*, Dept. Mines, Geol. Survey Branch, Ottawa.

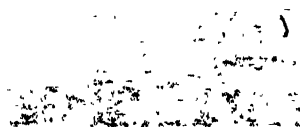

THE VILLAGE OF MACDIARMID

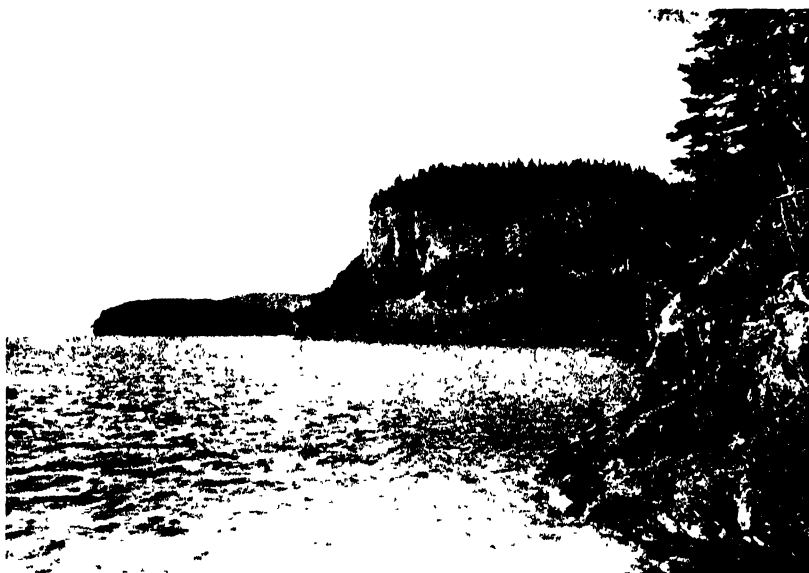

A TYPICAL STRETCH OF ROCKY SHORE NEAR MACDIARMID.

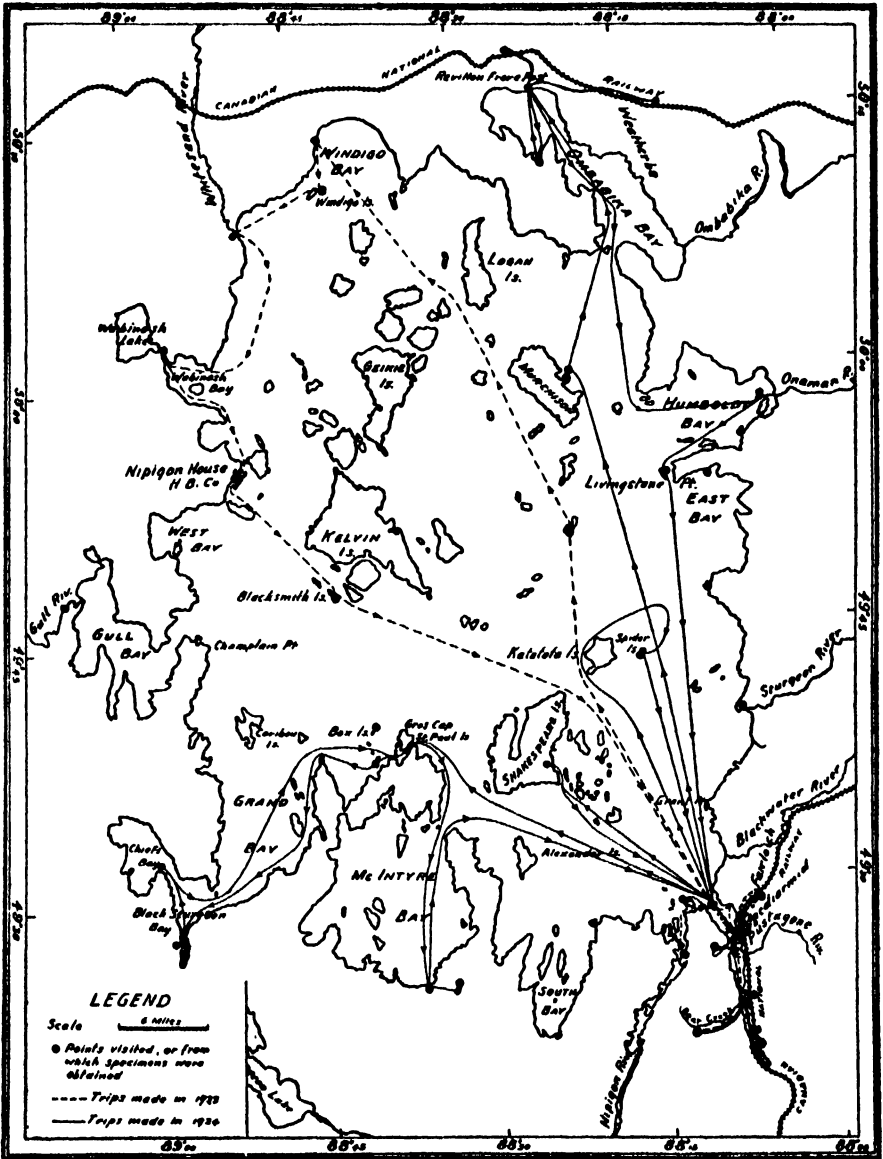

Map of Lake Nipigon

Dymond, Snyder and Logier on A Faunal Investigation of the Lake Nipigon Region

THE MAMMALS OF THE LAKE NIPIGON REGION

By J. R. DYMOND

The following paper is the result of observations and collections made during four summers (1921-24) which the writer spent on Lake Nipigon in connection with the work of the Fisheries Research Laboratory of the Department of Biology, University of Toronto. This work was done incidentally whenever time could be spared from the work of the Fisheries Laboratory and is necessarily less complete than could have been desired.

Valuable assistance in the accumulation of data was received from Mr. Duncan Bell of McIntyre bay, Lake Nipigon and Mr. P. McGuire, Factor of the Hudson's Bay Company's post at Nipigon House. For this assistance I wish to express my appreciation and thanks.

Specimens of the following were submitted to the Bureau of Biological Survey, Washington, D.C.: *Sorex c. cinereus*, *Sorex arcticus*, *Microsorex hoyi intervectus*, *Blarina brevicauda talpoides*, *Eutamias minimus jacksoni*, *Tamias striatus griseus*, *Peromyscus maniculatus maniculatus*, *Synaptomys cooperi fatuus*, *Eutamias g. gapperi*, *Microtus pennsylvanicus fontigenus*. For the examination and determination of this material I am very much indebted. My thanks are also due Dr. Glover M. Allen of the Museum of Comparative Zoology for the determination of the bat *Myotis l. lucifugus*.

The measurements given for some of the species are in millimetres. Unless otherwise stated, L. is the total length in millimetres from the snout to the end of the tail vertebrae, T. is the length in millimetres of the tail and H. F. the length in millimetres of the hind foot from the heel to the end of the longest claw.

Condylura cristata (LINN.). STAR-NOSED MOLE.—Only two specimens were taken, the first by Dr. Walter Koelz who spent two weeks on Lake Nipigon in July 1922. The other was trapped in a store at Gull Bay village on August 7, 1923. Average of two specimens: L., 188; T., 79½, H.F., 29½.

Sorex cinereus cinereus KERR. MASKED SHREW.—This is the species which before Jackson's recent studies of the shrews (1925a) has been known as *Sorex personatus*. Eight specimens taken, average measurements of six: L. 94; T., 39; H.F., 12. Specimens were taken

in damp woods, among rocks in a small clearing and among alders at the water's edge. The latter situation appeared to be a favourite one for this species.

Sorex arcticus KERR. (*S. richardsonii* Bachman. See Jackson *loc. cit.*). RICHARDSON'S SHREW.—Only two specimens taken. Average measurements: L., 103½; T., 43; H.F., 12½.

Microsorex hoyi intervectus JACKSON. HOY'S SHREW.—A specimen of this small shrew was taken at Macdiarmid by Mr. L. L. Snyder on June 27, 1923. This subspecies has recently been described by Jackson (1925b).

Blarina brevicauda talpoides (GAPPER). MOLE SHREW.—The mole shrew was very common being exceeded in point of numbers only by the white-footed mouse among the small mammals. It is perhaps most numerous in damp, cool woods but several specimens were also taken in drier situations and in clearings. Five were taken in two successive nights in August 1924 around a small water hole in the woods about 50 yards from my tent. Average measurements of 23 specimens: L., 117; T., 26½; H.F., 16.

Myotis lucifugus lucifugus (LE CONTE). LITTLE BROWN BAT.—This was the only species of bat of which we secured specimens. Bats were rarely seen on the wing and our only specimens were found by day in lumber piles.

Euarctos americanus americanus (PALLAS). BLACK BEAR.—Fairly common. In 1921 they were far more common than during any of the three succeeding years. During the autumn of that year more than a dozen were shot or trapped in the immediate neighbourhood of Macdiarmid. A favourite feeding ground is across Orient bay from the village where the offal resulting from the dressing of fish shipped to market together with the useless species taken in the fishermen's nets are thrown on the rocks to decay. No cinnamon specimens have been reported.

Procyon lotor lotor (LINN.). RACCOON.—Miller (1897) was told by Mr. William McKirdy of Nipigon that a few years previously a raccoon was killed by some Indians near Lake Nipigon and brought to the Hudson Bay Company's post. The Port Arthur News-Chronicle of November 8, 1921 reported that a farmer living in the vicinity of Kakabeka Falls (west of Fort William) had killed a raccoon in that district a day or two previously. This mammal, however, is not normally found in this part of Ontario.

Martes americana americana (TURTON). MARTEN.—Quite a number of martens are still taken in the Nipigon region but they are much less common than formerly. According to the Indians, a trapper sometimes got as many as 15 or 20 from one round of the traps whereas now he is lucky to get that number in a season.

A specimen taken December 15, 1921 near McIntyre bay was measured by Mr. Bell; L., 592; T., 188; H.F., 102. They vary much in colour from dark brown to yellowish.

Martes pennanti pennanti (ERXLEBEN). FISHER.—The fisher is also much less common than formerly but is still one of the valuable fur mammals of the district. A specimen taken on Gros Cap. Nov. 19, 1921 was measured by Mr. Bell; L., 864; T., 334; H.F., 125. A fire ranger reported seeing a female fisher with three young during the summer of 1922. Another ranger was said to have seen five young with an adult and thought the latter a more usual number.

Mustela cicognanii cicognanii BONAPARTE. SHORT-TAILED WEASEL.—The weasel was common throughout the region. A series secured for us during the winter of 1921-22 by Mr. Duncan Bell gave the following measurements: 4 males, L., 293; T., 81; H.F., 38; 2 females, L., 228; T., 55; H.F., 28.

A specimen taken on Nov. 10, 1921 still had considerable brown showing down the centre of its back, top of head and in the tail.

Mustela vison lacustris (PREBLE). MINK. Common. A specimen (male) secured for us by Mr. Duncan Bell measured: L., 594; T., 178; H.F., 67 and weighed 2 pounds 14 ounces.

Gulo luscus (LINN.). WOLVERENE.—The wolverene is not normally found in this district. One skin was brought into the Hudson Bay post at Nipigon House a few years ago but it is not known how close to Lake Nipigon it was taken.

Lutra canadensis canadensis (SCHREBER). OTTER.—A few otters are still taken around Lake Nipigon. They are said to have been common formerly.

Mephitis mephitis (SCHREBER). SKUNK.—Skunks were rather rare. Mr. and Mrs. Snyder saw one at the Revillon Frères post on Ombabika bay, in June 1924.

Vulpes fulva (DESMAREST). FOX.—Foxes appear to fluctuate in numbers with the hares. During 1921 and 1922 when the latter were so scarce very few foxes were taken, but previous to the last dying off of the hares they were more common.

Canis lycaon SCHREBER. GRAY or TIMBER WOLF.—The gray or timber wolf was said to be common and quite destructive to moose, deer and beaver. During the summer of 1920 Mr. A. Ticknor killed two which he overtook while they were swimming in the lake near the island of Katatota. Mr. McGuire says they will swim after moose and kill them in the water.

Besides the timber wolf there is a smaller form known as the brush wolf and some of the people of the district are of the opinion that there is still another small wolf distinct from the brush wolf which they believe to be the coyote. We saw only one wolf. This we took to be a young one. Its total length was 37 inches, tail 12 inches.

Lynx canadensis canadensis KERR. CANADA LYNX.—The Canada lynx was very scarce during the winter of 1921-22 presumably due to the scarcity of hares. It is usually quite common.

Marmota monax canadensis (ERXLEBEN). WOODCHUCK.—The woodchuck was rare except in clearings and along the railroad tracks. Individuals were seen on several occasions along the C.N.R. tracks in the vicinity of Macdiarmid, and at the Revillon Frères abandoned post on Ombabika bay, but Mr. Duncan Bell states that he has never seen one at McIntyre bay.

Only one adult and two immature specimens taken. The adult, a female, measured: L., 498; T., 132; H.F., 71.

Eutamias minimus jacksoni HOWELL. WESTERN CHIPMUNK.—This form of the western chipmunk, recently described by Howell (1925) ranges through northern Wisconsin, Minnesota and Michigan and eastward along the north shore of Lake Superior as far as Nipigon where it is said to intergrade with *Eutamias m. borealis*. Lake Nipigon is believed to be very near the eastern boundary of its range.

This chipmunk was observed most frequently about clearings,—around coal piles at Macdiarmid, near an old board walk at the abandoned Revillon Frères fur post at Ombabika bay, near the Mission house at McIntyre bay and in clearings around our tents. A specimen taken Aug. 19, 1921 had 438 seeds of lambs quarters (*Chenopodium album*) in its cheek pouches. Average of eleven specimens: L., 199; T., 94; H.F., 31.

Tamias striatus griseus MEARNS. EASTERN CHIPMUNK.—The eastern chipmunk was common. Average of eleven specimens: L., 258; T., 105; H.F., 37.

Sciurus hudsonicus hudsonicus (ERXLEBEN). RED SQUIRREL.—The red squirrel was not particularly abundant during the summers we spent on Lake Nipigon. Average measurements of seven specimens: L., 295; T., 117; H.F., 45.

Glaucomys sabrinus sabrinus (SHAW). NORTHERN FLYING SQUIRREL.—No flying squirrels were seen during our four summers on Lake Nipigon but four were collected for us by Mr. Duncan Bell during the winter of 1921-22. They are said to be quite common and to be frequently taken in traps set for fur-bearing mammals during the winter. Average measurements of four specimens: L., 313; T., 138; H.F., 40.

Castor canadensis canadensis KÜHL. BEAVER.—The beaver is still quite common especially back some distance from the lake and forms an important item in the fur production of the district. No specimens were taken.

Peromyscus maniculatus maniculatus (WAGNER). WHITE-FOOTED MOUSE.—White-footed mice were very common. During the summer of 1921 they were excessively abundant, entering stores and dwellings and swarming almost everywhere in the bush. Many were caught in our laboratory above the fish-packing plant. One evening four were taken in less than half an hour in two traps placed on the laboratory table not four feet from where one of the party was sitting and while half a dozen persons sat chatting within a few feet of the table. Out of doors they were taken in the deep bush, in dry clearings, in quaking bogs and by the water's edge. They became active at dusk but one was taken in a trap between 7 a.m. and 1 p.m.

During the early part of the following summer the mice were very scarce, none being taken until after July 1, although we had placed out more than a dozen traps on several occasions during the preceding month. They became more common later but could always be described as scarce throughout the entire season. During 1923 and 1924 they were more numerous but never approached their abundance during 1921.

It is believed that other species of small rodents suffered a reduction in numbers at the same time, for meadow mice, red-backed voles and mole shrews were also noticeably scarce during the early part of the summer of 1922. That the same condition prevailed over a much wider area is suggested by the migration of arctic foxes into the southern part of the Labrador peninsula during April and May 1922. According to Lewis (1923) thousands of Arctic foxes were trapped in southern Labrador before June 1 of that year during what he describes as "A notable in-

vasion of Arctic foxes". Cabot (1920?) has drawn attention to the periodic fluctuation in the numbers of mice in Labrador and its profound influence on the numbers and distribution of the predaceous birds and mammals of the region. What the species is or whether more than one species is involved is not indicated, except that he described "the mouse of the barrens" as "rather square built, about the size of a common field mouse, with shortish, stumpy tail". This makes it evident, however, that it is not the white-footed mouse that is concerned.

May it not be that the white-footed mouse plays a similar rôle in the northern coniferous forests of Canada to that played in the more northerly regions of Europe and America by the lemmings and voles? (see Elton 1924). Seton (1918) has expressed his view as to the importance of mice in these words: "What moss is to the reindeer, what grass is to the cattle, the mouse millions of the north are to all the northern carnivores from Bear to *Blarina*. When we shall have fully worked out the life-history of each of these species, I believe we shall learn that the whole of that vast beautiful, important, and specialized production that we call the carnivora rests on a broad simple basis of muridae that in turn rests on the grass, that rests on the earth. We shall for each of these flesh-eaters write, 'it sometimes eats this and sometimes eats that, but by far the greatest bulk of its food is mice.'"

Beyond the fact that the black bear was so abundant during 1921, we made no observations that seem to suggest a correlation between the abundance of mice and that of other creatures. The problem, of course, is complicated by the fluctuation in the number of hares which in this case were scarce when the mice were most numerous.

Average of 41 specimens, a number of which, however, were not fully mature: L., 172; T., 86; H.F., 20½. Largest specimens: L., 195; T., 93; H.F., 21. Eight of the forty-one specimens were 180 mm. or more in total length. It may be of some significance that the specimens taken in 1921 when they were so numerous, averaged smaller than those taken in 1924. Of twenty-one specimens measured in 1921, the average measurements were: L., 167; T., 85; H.F., 20½. Only two of these were of 180 mm. or over in total length and one of these came from Shakespeare Island where the population may not have been so dense. Of this, however, we have no data. Of ten specimens taken in 1924 the average measurements were: L., 175; T., 85; H.F., 20½ and four of the ten were 180 mm. or more in length.

***Synaptomys cooperi fatuus* BANGS. LEMMING MOUSE.—**

Three specimens were taken by Dr. Koelz while he was on Lake Nipigon in July 1922. One specimen, which he very kindly gave to our museum, measured: L., 108; T., 16½; H.F., 16½; female.

Evotomys gapperi gapperi (VIGORS). RED-BACKED VOLE.—The red-backed vole was not nearly so common, at least so far as the results of our trapping indicate, as the white-footed mouse or the meadow mouse. Most of our specimens were taken during the summer of 1921 when the white-footed mice were also so much more numerous. Average measurements of 14 specimens: L., 132½; T., 37½; H.F., 19. One was taken in a fire rangers' cabin which we occupied for two nights while camped on Humboldt bay in June 1924. Most of the others were taken in damp, cool woods although a few were trapped in higher, drier situations.

Microtus pennsylvanicus fontigenus (BANGS). MEADOW VOLE.—The meadow vole was fairly common in the clearing around Macdiarmid, especially along a little brook which flows through the southern edge of the village. Average measurements of 22 specimens: L., 147; T., 39; H.F., 20. The largest specimen measured 164 mm., and six of the twenty-two were 160 mm. or over in total length. One specimen was identified by Dr. Hartley H. T. Jackson as "*Microtus p. fontigenus* approaching "*pennsylvanicus*".

Ondatra zibethica zibethica (LINN.). MUSKRAT.—The muskrat is comparatively scarce around Lake Nipigon, no doubt due to the small area of marshy land about the lake. Our only specimen was caught in the trap net set for minnows in a small brook flowing through the southern edge of the village of Macdiarmid. It had drowned before the net was lifted. L., 505; T., 238; H.F., 76.

Mus musculus musculus LINN. HOUSE MOUSE.—No specimens were taken during 1921, although more trapping was done that season than during any succeeding year. The first specimen was taken June 16, 1922. Several others were trapped during the same season and by 1924 they had become fairly common. Practically all our specimens were trapped out-of-doors but within the village of Macdiarmid.

Zapus hudsonius hudsonius (ZIMMERMAN). JUMPING MOUSE.—This species was not uncommon. A specimen was found on Aug. 5, 1921 in a trap net set for fish in a small stream flowing into South bay. Whether it had entered the net alive and drowned, or floated in when dead is unknown. The species, however, appears to frequent the banks of streams as quite a number of our specimens were secured in such localities. Average of five specimens taken during July and August 1924: L., 214; T., 131; H.F., 30.

***Napæozapus insignis abietorum* (PREBLE).** WOODLAND JUMPING MOUSE.—The woodland jumping mouse was less common than the preceding species but like it, was commonly taken along streams. On May 26, 1922 a jumping mouse was seen near a small stream flowing into Sturgeon river. On being alarmed, it entered the water and either ran on the bottom or swam upstream a short distance, then took to the shore, and disappeared into a hole. It was seen for only a few seconds and its method of progression upstream was not clearly made out but it was not by the usual long leaps and it was along the course of the stream. This individual was presumed to be of this species on account of its bright tawny colour. Our observations agree with those of Goodwin (1924) that this species is sometimes active during the day-time. On May 29, 1922 another specimen of this species was seen about noon near the landing place at Sturgeon river. Snyder (1924) has described a nest of the jumping mouse and some features of its behaviour observed at Macdiarmid. Average of three specimens: L., 241; T., 155; H.F., 32.

***Erethizon dorsatum dorsatum* (LINN.).** PORCUPINE.—The porcupine was not very abundant around Lake Nipigon. One was seen on July 19, 1922 on the portage between Black Sturgeon bay and Black Sturgeon lake, and another was seen across the bay from Macdiarmid during the same summer.

***Lepus americanus americanus* ERXLEBEN.** VARYING HARE.—The varying hare was abundant in the Lake Nipigon region during the summer of 1924. In 1921 they were quite scarce but it was difficult to determine definitely the year when they had last been wiped out after reaching their periodic maximum of abundance. From enquiries which I made, it seemed probable, however, that it was during the winter of 1918-19 that they had died off.

On the night of June 18, 1924 while sleeping in an abandoned building at the Revillon Frères post on Ombabika bay, we were disturbed by an animal gnawing in the next room. From the vigorous nature of the gnawing we at once decided that a porcupine was at work and as we had secured no specimen of this mammal we proceeded to set some traps. Hardly had we returned to our beds when the trap was sprung and examination showed that we had caught a hare. The trap was reset and before we had fallen asleep a second specimen had been taken. Next day we heard a similar gnawing and were able to approach quite closely to the animal. The boards that were being gnawed were of hard wood and formed part of the floor of what had been a boarding house during railway construction days. The gnawing was not a continuous

operation, the hare would rasp the edge of the board vigorously for a few seconds and then cease, apparently to rest for it was quite noticeably panting between gnawing operations. Only two adults taken: L., 444; T., 38; H.F., 135.

Odocoileus virginianus borealis (MILLER). WHITE-TAILED DEER.—The white-tailed deer is a comparatively recent addition to the fauna of the region. It is difficult to fix the date when the species reached Lake Nipigon but it came in after the moose, perhaps twenty-five years ago. Shiras (1921) states that this deer was unknown on the north shore (of Lake Superior) when he came to the region in 1870. It is not yet nearly so numerous around Lake Nipigon as the moose but is rapidly increasing in numbers.

Alces americana americana (CLINTON). MOOSE.—Moose are now abundant in the Nipigon region although according to the Indians, they were formerly unknown there. This is supported by the statement of Shiras (*loc. cit.*) who says that when he first visited Lake Superior in 1870, moose were practically unknown on the southern or northern shores of this lake, and the same was true, he says, of a large area north of Lake Huron. The invasion by the moose of this territory formerly occupied only by the caribou, Shiras attributes to the improvement in the food conditions through the partial clearing of the country by lumbering and forest fires, followed by the second growth of poplar, birch and other trees and the increase of ground vegetation. Although the territory immediately surrounding Lake Nipigon now forms part of the Nipigon Forest Reserve and has never been cut over nor visited by any serious fires for many years, Bell (1870) found evidence in the Nipigon country that the forests had been swept by fires in past times and the Indians told him that these fires often originated from lightning. We ourselves saw a tree set afire by lightning on July 14, 1922 on the hills across the bay from Macdiarmid. This fire was put out by the fire rangers. We were told that it was not unusual for lightning to strike trees in that locality and it was popularly believed that this was due to the presence of iron-bearing rocks. Whatever has been the cause of the migration of the moose into the region, it is evident that they have found conditions here suitable, for they are now very abundant. Mr. Dan Kerr, a fire ranger stationed at a lookout tower near Macdiarmid has seen eleven moose feeding at one time in the little lake at the foot of the hill on which the lookout tower was situated.

Bell (1897) believes that the moose migrates slowly from one large area to another through periods extending over many years and states that in the Gaspé Peninsula the last interval between its leaving and

again returning to the same district was upward of half a century and in the region between the upper Great Lakes and James bay the period between his last withdrawal and reappearance has been still longer.

Moose were seen on numerous occasions by members of our party. One or two incidents so observed may be worth recording. On July 10, 1923 L. L. Snyder and the writer observed a cow moose feeding in a small lake on a plateau some distance above the level of Lake Nipigon. We had approached the lake noiselessly so as not to scare any ducks which may have been present. On reaching the edge of the lake we saw a brown object in the water about thirty-five or forty yards from us. At first glance it was taken for a log but we soon saw that it was the shoulders of a moose. In a few moments she raised her head but soon put it under the water again and resumed her feeding. At times she was completely submerged; at other times only the points of her shoulders were visible above the water. Sometimes the head was kept under water as long as half a minute but usually for only twenty seconds or less. When she raised her head she sometimes chewed for a short time and sometimes resumed her feeding on the bottom as soon as she had taken a breath of air. After feeding for perhaps fifteen or twenty minutes she waded to shore, shook herself, giving the ears two or three extra shakes and then disappeared, but so noiselessly that we could scarcely believe that she had walked into the bush.

On June 2, 1922 while camped on the Gull river about three miles from the lake, when making breakfast about 8 a.m. a young moose appeared on the opposite shore of the river making a sound resembling that of a child crying. After hesitating for a moment it started to swim towards us. When about ten yards from the shore on which we were standing it turned and swam back to the side from which it had come. The Indians at Gull bay village about a mile away told us afterwards that it had been wandering about alone for two weeks. At the time we saw it the Indians suggested that it would be about a month old and it could not have been much older than that for the young are born here towards the end of April or beginning of May. During that spring and the preceding winter large numbers of moose had died in the district. The Indians believed the loss to be due to ticks and we were given a specimen which was said to have been taken from a dead moose. Unfortunately the specimen was lost before it could be identified. It is quite probable that it belonged to the same species (*Dermacentor albipictus* Packard) that is reported to have been responsible for the death of so many moose in northern Saskatchewan in the spring of 1916 (Report of the Chief Game Guardian, 1916. Department of Agriculture, Regina, Sask.).

Rangifer caribou (GMELIN). WOODLAND CARIBOU.—The caribou was formerly the only deer found in the district but has become uncommon especially since the construction of the National Transcontinental Railway across the north end of the lake between 1908 and 1912. Mr. T. U. Fairlie of the Engineering Department of the Hydro-Electric Power Commission, who was engaged on preliminary location work in connection with the building of the railway, in a letter to the writer states "I was in the district to the north and east of Lake Nipigon in 1904 and 1905 and saw a considerable number of moose, which occasionally travelled in pairs. I saw no red deer for two years, but occasionally saw caribou and on only one occasion on a small muskeg lake about a mile east of Kowcash lake, I saw a herd in January 1905 of 28 caribou. This was the largest herd I saw. We saw evidences of herds at different points, but failed to see the animals".

Fresh tracks were seen in the sand on the beach of Russell Island, Lake Nipigon on July 27, 1922; Aug. 20, 1923 and June 30, 1924, and W. J. K. Harkness and C. S. Hanes saw a male on the Kabitotikwia river on July 24, 1924. Quite a number summer in out of the way places throughout the district.

LITERATURE CITED

- Bell, Robert 1870. On the Nipigon territory. *Can. Naturalist, N.S.*, **5**: 120.
- Bell, Robert 1898. On the occurrence of mammoth and mastodon remains around Hudson Bay. *Migrations of northern mammals. Bull. Geol. Soc. America*, **9**: 376.
- Cabot, William B. 1920? Labrador. Boston: Small, Maynard & Co.
- Elton, C. S. 1924. Periodic fluctuations in the numbers of animals: their causes and effects. *British Journal of Experimental Biology*, **2**: 119-163.
- Goodwin, George G. 1924. Mammals of the Gaspé peninsula, Quebec. *Jour. Mammal.*, **5**: 255.
- Howell, Arthur H. 1925. Preliminary descriptions of five new chipmunks from North America. *Jour. Mammal.*, **6**: 53.
- Jackson, Hartley H. T. 1925a. The *Sorex arcticus* and *Sorex cinereus* of Kerr. *Jour. Mammal.*, **6**, 55-56.
- Jackson, Hartley H. T. 1925b. Two new pigmy shrews of the genus *Microsorex*. *Proc. Biol. Soc. Wash.*, **38**: 125-126.
- Lewis, Harrison F. 1923. Additional notes on birds of the Labrador peninsula. *Auk*, **40**: 136.
- Miller, Gerritt S. Jr. 1897. Notes on the mammals of Ontario. *Proc. Bost. Soc. Nat. Hist.*, **28**: 41.

- Seton, Ernest Thompson 1918. Life histories of northern animals, **2**: 918.
- Shiras, Geo., 3rd 1921. The wild life of Lake Superior, past and present. Nat. Geog. Mag., **40**: 130.
- Snyder, L. L. 1924. Some details on the life history and behavior of *Napaeozapus insignis abietorum* (Preble). Jour. Mammal., **5**: 233-237.
- Report of the Chief Game Guardian, 1916. Department of Agriculture, Regina, Sask.

THE SUMMER BIRDS OF LAKE NIPIGON

By L. L. SNYDER

INTRODUCTION AND ACKNOWLEDGEMENTS

Although considerable information is extant on the distribution of birds during the breeding season in the vast Province of Ontario, additional data are needed from many localities, especially in Northern Ontario, where little or no work has been done. Lake Nipigon presented a field of this kind. The geology, botany, ichthyology and limnology of the area have been studied more or less extensively but no systematic record of the summer bird life had been made. It seemed particularly desirable to undertake this work before conditions had become changed by deforestation and industry, and consequently the writer spent the months of June and July, 1923, in field collecting. In 1924 the same months and early August were also spent in the region. The following account of the summer birds is based principally on the collection of skins and the field notes made during these two summers.

The grateful acknowledgement of the writer is due the following persons who in various ways have assisted in the work: Mr. J. H. Fleming of Toronto for his advice and for the use of considerable comparative material; Mr. P. A. Taverner of Ottawa who kindly examined specimens referred to him; Dr. Walter Koelz who has communicated notes relative to certain birds observed by him at Lake Nipigon during the summer of 1922; Mr. J. L. Baillie of the Museum staff who acted as field assistant during the summer of 1924; and the members of the Fisheries Research Laboratory and Museum staff who assisted in many ways.

GENERAL ACCOUNT

The area with which the present paper is concerned includes the whole of Lake Nipigon and its immediate shores, no excursions penetrating more than five miles inland having been made during field work. This area consists of approximately 2800 square miles.

A headquarters camp was located at Macdiarmid, a fishing village on Pijitawabik bay (known locally as Orient bay) and it was in this region that a more intensive survey was made, especially during the summer of 1923. From this base, trips were made to other points on the lake. On the map on plate X the points visited are indicated by a black dot

and in most cases these marks represent the centre of a reconnoitered area.

The collecting of material was carried on selectively, an attempt being made to secure representative skins of each species occurring in the region in summer. In many cases both sexes are represented and in some the nestlings or immatures as well. In some cases, more particularly where subspecific identity was in question, a series of skins was secured. The collection comprises 313 skins representing 92 species and subspecies, a catalogued collection of the stomachs of all the birds collected, a number of internal and external parasites, 11 nests with eggs and a number of identified nests without eggs and seven nestlings in alcohol.

ANNOTATED LIST

There are 99 species or subspecies of birds included in the following list, 92 of which are represented in the collection made by this survey. The other records are based on positive field identifications made by us and material secured by Dr. Walter Koelz in 1922. No reference is made to Wilson's list since it was not confined to summer birds and was admittedly incomplete.

A catalogue of the specimens secured by us is included in which all young of the year are indicated by "Juv."; birds without mature plumage but known to be in the second year are designated as "Im."

The classification used is that of the Third Edition of the American Ornithologists' Union Check List, 1910, and the nomenclature conforms with this edition with such revisions as have been since made in the supplements published in the 'Auk.'

The matter relating to each species has been paragraphed in the following order,—identity, abundance and local distribution, evidence as to whether the species breeds in the locality or not, and general remarks. Where comment is unnecessary or where information is lacking the corresponding sections have been omitted.

Gavia immer. LOON.—In proportion to the extent of apparently favourable habitat, this species was not common. Single individuals or pairs were seen at widely separated points on Lake Nipigon while none was seen on the numerous small inland lakes in the region.

Two partly feathered young in company with an adult were seen off Shakespeare island on Aug. 4, 1924.

Loons were well known to the fishermen, who mildly objected to their presence, principally on the grounds that they entered the pound-nets and were difficult to remove. They did some damage to the trapped fish but on account of their scarcity were not a serious menace

to fishing. The Indians of the region consider loon's flesh to be good when boiled.

♂ July 18, 1924. East bay.

♀ July 26, 1924. East bay.

Larus argentatus. HERRING GULL.—These birds were commonly observed when we were making a lake trip and numbers continually followed the fishing tugs. From forty to seventy-five individuals could be noted about Orient bay on the days when the fishing tugs returned to Macdiarmid. These had followed the boats to port and would gorge themselves on the refuse from fish-dressing operations, which was deposited across the bay.

Four breeding colonies were discovered, one on Box island (J. R. Dymond, May 30, 1922); one on a small island at the entrance to McIntyre bay (known to residents as Grand bay); one on a small rock island about one mile off the northeast shore of Murchison island; and one on a rock cliff on the southwest shore of Ombabika bay. The colony off Murchison island was examined on June 18, 1924, and both newly hatched young and eggs were noted in numbers varying from two to three in a nest. This colony comprised approximately twenty-five pairs.

It seems doubtful if the herring gull does much independent fishing on Lake Nipigon, the offal from the fishing industry affording it a constant food supply. On the rock off Murchison island a number of ling (*Lota maculosa*) were scattered about. These had probably been found dead by the gulls, as numbers of ling taken from the nets and killed by the fishermen are thrown overboard. Individuals appear to forage over the entire lake, thirty-six adults having followed our boat on one occasion for over twenty miles. Although flocks of gulls were carefully examined, *argentatus* was the only species seen. No brown immatures were noted except late in the season. It would seem, therefore, that Lake Nipigon is primarily a breeding area and not a feeding range for non-breeding birds.

Jun. ? June 22, 1924. Murchison island. 2 ? July 5, 1923. Naonan island.

Phalacrocorax auritus auritus. DOUBLE-CRESTED CORMORANT.—Cormorants were not common on Lake Nipigon and were not noted during the summer of 1923, although known to the fishermen, who called them "Soldiers", a name derived from their habit of sitting somewhat upright in what would appear to be straight alignment.

On June 18, 1924, a breeding colony of double-crested cormorants, the first to be found in Ontario, was discovered on a small rock island, about sixty feet long and fifty feet wide, off the northeast shore of Murchison island. On the same island nested a number of herring

gulls. Nineteen cormorants' nests were counted, and all but one were occupied. The nests contained from four to five naked young, or eggs, or both. Those examined were infested with fleas (unidentified), a large number of which were preserved. Individual cormorants were seen at two other places on Lake Nipigon but no other breeding grounds were found.

The species, according to fishermen, is occasionally taken in the pound-nets, but this is rather unusual, as it prefers to feed in deeper water than that in which pound-nets are set.

Juv. ? June 18, 1924. Murchison island, ♂ June 18, 1924. Murchison island.
(alcoholic).
♀ June 18, 1924. Murchison island.

Mergus americanus. MERGANSER.—The status of this species at Lake Nipigon was not satisfactorily worked out. Mergansers were fairly well distributed about the rocky shores of the mainland and islands, but because of the difficulty in approaching them few were collected. Although field identification was seldom certain, it seems that this species occurs on the lake as frequently as the next.

Mergansers breed on the rocky shores of the mainland and of the islands. Broods of mergansers were noticeably smaller than is frequently recorded, six or seven being the largest number noted.

Mergansers were never noted on the inland lakes nor were they characteristic of the shallow bays of Lake Nipigon. Males were rarely seen and then only at considerable distances, usually near islands far out in the lake. They were not well known to the fishermen and although the two species constituted the most common ducks of the more open water and fed upon small fish, they were not looked upon as detrimental to fishing.

♀ June 20, 1923. Macdiarmid. Juv. ♂ July 4, 1924. Virgin islands.
Juv. ♀ July 4, 1924. Virgin islands. Juv. ? July 4, 1924. Virgin islands.

Mergus serrator. RED-BREASTED MERGANSER.—Not sufficient material was collected to estimate the comparative abundance of this species and the preceding, but it seems probable that they occur in about equal numbers. The evidence at hand, however, makes it clear that the breeding ranges of the two species overlap in the Nipigon region.

A well preserved but abandoned nest of a merganser, thought to be of this species, was found on the boulder-strewn shore of a small island near the northeast shore of Ombabika bay. A family consisting of an adult female and five young was seen off the Windigo islands on July 27, 1923, one young being secured.

Like the preceding species, the red-breasted merganser seems to prefer to feed in the clear, deep water about islands. No males of this species were positively identified in the field during either summer.

Juv. ♂ July 27, 1923. Windigo islands.

Anas platyrhynchos. MALLARD.--This species was met with in only three localities, Humboldt bay, Black Sturgeon bay and Chief bay. The area suited to this duck is comparatively small and it was probably never present in great numbers.

A female and two downy young were observed at the mouth of the Onaman river in Humboldt bay on June 29, 1924. Single females were observed at the two other localities mentioned above and it is probable that they were also breeding birds. A single male was seen in Humboldt bay the day previous to our noting the female with young. Since it was seen in the same small bay in which the family was observed, it may have been the male parent of the brood, not yet having disassociated himself from the female.

Unlike the diving ducks the female mallard took wing when approached, leaving the young to escape by concealment in the vegetation bordering the bay.

Juv. ♂ June 29, 1924. Humboldt bay.

Anas rubripes. BLACK DUCK.--From the evidence secured it is doubtful if this species is a regular summer resident of the Lake Nipigon region. The only specimen seen was flushed from a small grassy lake near Macdiarmid on June 17, 1924. Although a number of subsequent visits were made to the same lake it was not seen again.

Glaucionetta clangula americana. GOLDEN-EYE.—This was the most common duck of the Nipigon region, but peculiarly enough only one male was identified during the two summers, viz., on June 28, 1924, off Murchison island.

Practically all of the small inland lakes harboured at least one family of golden-eyes and they were also found in the mud bottomed, grass-grown bays. These families usually consisted of a female and from four to six young. The largest number of young observed in one brood was ten. Young were first observed following the female during the last week of June.

A family of golden-eyes resorts to a number of methods of escape when threatened. When the first sign of danger appears the females usually lead the young quickly, but quietly, to the nearest shelter along shore. If this fails to elude the enemy they meet the emergency by

dashing from their retreat, attempting to put distance between them and their pursuer in order to repeat their ruse. However, if hard-pressed, their next resort is to dive. If chase is continued after each member as it reappears on the surface of the water, it dives again immediately and the whole family is soon lost completely, scattered and submerged in all directions. Once or twice while watching this performance I have been able to detect a submerged bird come to the surface and disappear again in a flash, hardly disturbing the water about it. This method of taking air (and keeping sight of an enemy) is difficult to detect but is probably more common than the supposed method of protruding the bill above the surface of the water. Females usually remain with their young when alarmed, but on one or two occasions I have known them to fly. The young are capable of evading ordinary dangers by the method described above but at least one other method is practised when they are still very young. On June 29, 1924, a female golden-eye was observed in open water with two newly-hatched young. When the young became tired by the rapid pace set by the female she retarded her progress and allowed them to climb on to her back, where she carried them for a considerable distance. The young of this species were still flightless when field work was discontinued, during the second week of August, 1924; a specimen taken on August 9 having the under feathers of the body well developed, while the back, except the scapulars, which were well developed, was covered with down. The rectrices were nearly fully developed, while the flight-feathers were very imperfectly so.

2 Juv. ♀	July 10, 1923.	Newt lake.	Juv. ♀	June 29, 1924.	Humboldt bay.
Juv. ♂	July 10, 1923.	Newt lake.	♀	July 3, 1924.	Macdiarmid.
♀	July 14, 1923.	Macdiarmid.	♀	July 4, 1924.	Naonan island.
♀	July 17, 1923.	Macdiarmid.	2 Juv. ?	July 15, 1924.	Chief bay.
Juv. ♀	July 20, 1923.	Fairloch.	Juv. ?	July 26, 1924.	Orient bay.
♀	July 20, 1923.	Fairloch.	Juv. ♀	Aug. 9, 1924.	Humboldt bay.

Oidemia deglandi. WHITE-WINGED SCOTER.—On June 18, 1924, five of these ducks were seen on Ombabika bay. It is not known whether the species breeds within the area or not as this was the only occasion on which it was seen during the two summers.

Botarus lentiginosus. BITTERN.—In the more heavily vegetated bays and in the grassy borders of some of the inland lakes bitterns were occasionally flushed.

The species breeds in these situations, a nest with four fully feathered young having been found near a small lake northeast of Macdiarmid, on July 23, 1924. Another nest, abandoned, and probably of the preceding year, was found at Humboldt bay in late June, 1924.

The bittern may feed a considerable distance from its breeding ground as is known to be the case with other members of its family. One individual was frequently seen flying from its nesting place to the mouth of the Pustagone river, two and one-half miles distant, to feed. The trips to the feeding place were usually made about 5 p.m. An unusual observation of this species was made when a bittern was seen to alight in the top of a dead spruce tree and remain perched there for some time.

♀ July 4, 1923. Bear creek. 2 Juv. ♂ July 23, 1924. Macdiarmid.
 ♀ July 19, 1924. Macdiarmid.

Pisobia minutilla. LEAST SANDPIPER.—One specimen was taken on the rocky shore of Windigo bay on July 26, 1923. Although the specimen was in all probability an early returning migrant, it is included in the present list because of its occurrence in the region during the summer.

♀ July 26, 1923. Windigo bay.

Totanus melanoleucus. GREATER YELLOW-LEGS.—A crippled individual was found feeding along the muddy banks of Bear creek on June 15, 1924. It was again noted by members of the Fisheries Laboratory later in the season near the same place. This bird, which was incapacitated by a broken leg, was probably unable to reach its breeding grounds to the north and was of accidental occurrence at Lake Nipigon in summer.

Actitis macularia. SPOTTED SANDPIPER.—The spotted sandpiper was common in suitable situations about the lake.

The earliest date on which a full clutch of eggs was found was June 19, in both years.

Record has been made of some more or less unusual behaviour of this species as noted at Lake Nipigon. (Snyder 1924a).

♂ June 19, 1923. Orient bay. Juv. ♂ July 26, 1924. Orient bay.

Oxyechus vociferus. KILLDEER.—The killdeer was not a common bird for the region as a whole, but a pair was usually to be found on the more suitable sandy flats along the shores of some of the bays.

Downy young were seen by the last of June but no nests with eggs were found. The breeding grounds of this species will doubtless be reduced by the projected raising of the lake level.

A newly hatched young held in the hand was observed to have a weak call-note which was an exact imitation of the loud "killdee"

note of the adult. The adroitness of the young at concealment is no less effective than the behaviour of the parents when the young are in danger. On account of their behaviour it was impossible at times to determine the position of the young within a hundred yards, the parents being concerned as much with one situation as with another.

Juv. ♀ June 20, 1924. Ombabika bay.

♀ June 28, 1924. Humboldt bay.

Canachites canadensis canace. CANADA SPRUCE PART-RIDGE.—There is some variation in the colour of the female specimens secured, most of which can be accounted for by wear. This complicates the subspecific determination of the birds, but geographically the Nipigon region is nearer the range of the subspecies *canace* than it is to that of *canadensis*. Insufficient material was available for satisfactory comparison but Mr. Taverner who examined these specimens calls them *canace*.

The species was not common, none being noted in 1923.

Newly hatched young were met with on two occasions and specimens were secured.

The notes of the downy young of this species were noted to be very similar to those of a domestic chick.

♀ June 21, 1924. Ombabika bay.

♀ June 30, 1924. Russell island.

Juv.? June 27, 1924. Ombabika bay.

♂ July 17, 1924. Macdiarmid.

2 Juv.? June 30, 1924. Russell island.

♀ Aug. 1, 1924. Macdiarmid.

Bonasa umbellus togata. CANADA RUFFED GROUSE.—Of the seventeen specimens taken, twelve are adults or feathered young. This series is referable to the subspecies *togata*, the general colour of the upper parts being a grayish brown. There is an interesting variation in the amount of black on the dorsal feathers but this is partially due to wear. The series shows rather uniformly gray tails. The specimens can be matched with birds from southern Alberta and British Columbia as well as from northern and central Ontario.

Grouse were fairly common in the Nipigon region during both summers, being seen regularly near settlements as well as in the wilder parts.

Newly hatched young were first seen by the last week of June.

With one exception all males collected or identified in the field were solitary birds preferring the deeper woods. One male, however, was flushed in company with two hens, both of which, to judge by their behaviour, were concerned with the numerous young which scattered and concealed themselves in the leaves. On June 26, 1924, a downy young grouse, capable of flying ten or fifteen yards, was collected. The wing of this specimen measured 44 mm.

Juv. ? June 28, 1923.	Macdiarmid.	Juv. ♂ June 26, 1924.	Ombabika bay.
♂ June 14, 1924.	Macdiarmid.	Juv. ? July 3, 1924.	Macdiarmid.
♂ June 19, 1924.	Ombabika bay.	4 Juv. ? July 16, 1924.	McIntyre bay.
♂ June 21, 1924.	Ombabika bay.	♀ July 24, 1924.	Macdiarmid.
4 Juv. ? June 21, 1924.	Weatherbe.	Juv. ♂ July 26, 1924.	Orient bay.
♀ June 21, 1924.	Weatherbe.		

Circus hudsonius. MARSH HAWK.—This hawk is of rare occurrence in the Nipigon region, only one pair being seen. Open muskeg, or bogs where tree growth is stunted and thin, were not extensive in the region; thus the habitat of the species was limited.

A nest with four eggs and a newly hatched young was collected in an open bog on the north shore of Ombabika bay on June 22, 1924. The nest, made of alder twigs and thickly lined with dry grass, was placed on a slight elevation in the moss.

Juv. ? June 25, 1924. Ombabika bay, (alcoholic).

Accipiter velox. SHARP-SHINNED HAWK.—An adult female was taken on July 22, 1923, at Macdiarmid, and the species was noted on two other occasions, once near Orient bay station in 1923 and again at Black Sturgeon bay in 1924.

No evidence that the species bred in the region was secured.

♀ July 22, 1923. Macdiarmid.

Buteo platypterus. BROAD-WINGED HAWK.—This species was the most common hawk of the region, being observed in practically every locality visited. Its characteristic notes were heard almost daily.

The immature bird taken was in badly worn plumage and was seen in company with a bird of mature plumage.

♂ July 5, 1924. Macdiarmid.

Im. ♂ July 7, 1923. Macdiarmid.

Haliaeetus leucocephalus alascanus. NORTHERN BALD EAGLE.—A few pairs were known to occur in the region, two individuals having been seen at Gros Cap on July 14, 1924, and one on the following day at Chief bay.

An almost fully feathered young was secured from a nest on East bay and at least one other nest was known to residents of the region. An adult eagle seen on July 15, carrying a stick in its talons, was probably enlarging or repairing its nest.

Juv. ? July 8, 1924. East bay.

Falco columbarius columbarius. PIGEON HAWK.—The

pigeon hawk was found to be fairly common and generally distributed over the area covered.

A nest with two downy young was found on July 2, 1924. It was situated twenty feet from the ground near the trunk of a live white spruce and was composed of barked twigs and lined with moss, cedar-bark fibre, bits of paper and scraps of discarded fish nets.

The adults collected were dark in colour being examples of the dark females and immatures of this form. No light specimens were noted in the field.

2 Juv. ? July 2, 1924. Orient bay.
♀ July 2, 1924. Orient bay.

♀ July 26, 1923. Windigo bay.
Juv. ♀ July 27, 1923. White Sand river.

***Cerchneis sparveria sparveria*. SPARROW HAWK.**—This hawk was fairly common and well distributed through the region.

Nests were found in abandoned woodpecker holes during both summers.

A male which was attempting to pick up the downy young of the ruffed grouse was collected on June 21, 1924.

♂ June 21, 1924. Weatherbe.

♀ July 10, 1924. Macdiarmid.

***Pandion haliaëtus carolinensis*. OSPREY.**—This species was seen during both summers. It appeared to be more common at the northern part of the lake than elsewhere. Its local distribution seemed to depend somewhat on the presence of shallow bays. An osprey was seen feeding on a northern sucker, *Catostomus catostomus*. This fish is normally found in fairly deep water in the lake but resorts to streams in spring to spawn, and it was from a stream that the osprey in question was seen to take the sucker.

One nest was found situated on the top of a live white spruce some ninety feet from the ground. It was estimated to measure at least four feet in diameter and as much vertically. Although it could not be examined the behaviour of the adults suggested the presence of young.

♀ July 5, 1924. Orient bay.

***Asio wilsonianus*. LONG-EARED OWL.**—A single specimen was taken on the north shore of Ombabika bay. The Indians to whom it was shown had never seen the kind before and it appears not to be numerous in the region.

♂ June 24, 1924. Ombabika bay.

***Cryptoglaux acadica acadica*. SAW-WHET OWL.**—We did not meet with this species during either summer at Lake Nipigon but Dr.

Walter Koelz collected two young in the Kirtland's owl plumage, one of which is in the Museum of Zoology, University of Michigan. These young were taken on July 21, 1922, near Macdiarmid and were probably reared in that vicinity.

Bubo virginianus pallescens. WESTERN HORNED OWL.—Two juvenile specimens were secured. Mr. P. A. Taverner, to whom they were submitted, refers them to the subspecies *pallescens* within the A. O. U. meaning of the name. He remarks that, "It is evident that this north Lake Superior country is out of the breeding range of the red eastern *B. v. virginianus*". An adult seen in the field but not secured impressed the writer as being a strikingly grey bird, noticeably different from the typical eastern form.

The species was known to breed in at least two localities on Lake Nipigon, near Macdiarmid, and a mile or two up Bear creek.

Juv. ♀ June 23, 1923. Macdiarmid. Juv. ♂ June 23, 1923. Macdiarmid.

Ceryle alcyon alcyon. BELTED KINGFISHER.—The species was locally common. It seems probable that it has increased since the railroad was constructed, as it appears to nest exclusively in the sand-banks along the right of way.

Its tunnels were to be found in many of the exposed banks but no evidence was found of its nesting in the crevices in the rock cliffs along the lake shore. A nest examined on July 3, 1923, contained seven partly feathered young.

♀ June 20, 1923. Macdiarmid.

Dryobates villosus leucomelas. NORTHERN HAIRY WOODPECKER.—It is evident that the Nipigon birds of this species are intermediate between typical *villosus* and *leucomelas*. If 5 inches (127 mm.) in wing length is accepted as a dividing point between the two forms, two specimens collected are readily referable to the latter while a third specimen tends very slightly to the former. The measurements of the culmens exhibit an intermediate tendency. With the slight evidence in favour of *leucomelas* the specimens are referred to that subspecies.

Hairy woodpeckers were not common at Lake Nipigon although they were seen at a number of localities. They were not nearly so frequently met with as was the downy woodpecker.

The species breeds in the region, a scattered brood having been seen at Windigo bay on July 26, 1923.

Juv. ♀ July 26, 1923. Windigo bay.
♂ June 4, 1924. Macdiarmid.

♀ June 6, 1924. Macdiarmid.

Dryobates pubescens medianus. DOWNY WOODPECKER.—

This was the most common of the woodpeckers of the region, being especially in evidence in the mixed forest where there was standing dead birch.

A number of nests were found, especially late in the season when the hungry young in the nest were particularly noisy. The three juveniles collected were carefully sexed and the crown markings were found to indicate the sex as previously suggested by the writer. (Snyder 1924b.)

♂ June 12, 1923.	Macdiarmid.	Juv. ? July 16, 1924.	McIntyre bay.
♂ July 12, 1924.	Macdiarmid.	Juv. ♀ July 23, 1924.	Macdiarmid.
Juv. ♀ July 16, 1924.	McIntyre bay.	♀ Aug. 5, 1924.	Shakespeare island.
Juv. ♂ July 16, 1924.	McIntyre bay.		

Picoides arcticus. ARCTIC THREE-TOED WOODPECKER.

—This three-toed woodpecker was not an uncommon species. It frequented both the mixed forest and the black spruce forest but was more often seen in stands of dead black spruce.

Two nests were found, one at Bear creek and another on the north shore of Ombabika bay. Both of these were occupied by young.

♀ June 27, 1923.	Bear creek.	♀ July 12, 1924.	Macdiarmid.
♂ June 10, 1924.	Macdiarmid.		

Sphyrapicus varius varius. YELLOW-BELLIED SAPSUCKER.

—This species was rare, having been noted at only three localities.

A family seen at McIntyre bay was the only evidence that the species breeds in this area.

Juv. ♂ July 16, 1924. McIntyre bay.

Phlœotomus pileatus abieticola. NORTHERN PILEATED WOODPECKER.—This woodpecker was generally distributed throughout the heavily forested areas but was not numerous in any section.

A nest containing two young was found in the trunk of a live aspen on St. Paul island, and a pair nested in a dead paper birch in the clearing at Macdiarmid.

A large charred stump which stood in the clearing at Macdiarmid was used daily in the early part of the summers of 1923 and 1924, by a male pileated woodpecker, as a "drumming post". The loud, slightly accelerated rapping was alternated with the boisterous, flicker-like call of the species. Occasionally individuals were flushed from near the ground where they were feeding. Their large tapered drillings were found at the bases of living white cedars showing the remarkable ability of the species to locate insect-infected spots in green wood.

♂ June 25, 1923. Orient bay. Juv. ♂ July 14, 1924. St. Paul island.
 Juv. ♀ July 14, 1924. St. Paul island.

Colaptes auratus borealis BOREAL FLICKER.—Geographically the Nipigon birds belong to the subspecies *borealis* although one specimen taken is not as large as the average for that form. The other however, is a large bird measuring 317 mm. in length and 36 mm. along the culmen.

Flickers were quite frequently found in and about clearings and on a few occasions were met with in the wilder parts of the mixed forest.

A number of flicker nests were found, one of more than ordinary interest having been located in a dead stub in a clearing south of Orient Bay station; the entrance was but eighteen inches from the ground and the young, which were nearly ready to leave the nest, were almost at ground level when at the bottom of the nesting chamber.

♂ June 22, 1924. Ombabika bay. ♂ July 3, 1923. Macdiarmid.

Chordeiles virginianus virginianus. NIGHTHAWK.—The nighthawk was not a common bird of the region as a whole.

Two immature specimens were secured at Macdiarmid and what was thought to be a family was seen nightly, feeding over our camp clearing at Ombabika bay during the last week of June, 1924.

During the breeding season the species was very silent, neither vocal nor mechanical sounds having been heard from the birds observed.

2 Juv. ? Aug. 19, 1923. Macdiarmid.

Archilochus colubris. RUBY-THROATED HUMMINGBIRD.—The species was seen during both summers at Macdiarmid but was not common in the region as a whole.

The flowering plants about the houses at Macdiarmid attracted adults throughout the summer but no evidence was secured as to whether the species bred in the region.

Juv. ♂ Aug. 11, 1923. Macdiarmid

Tyrannus tyrannus. KINGBIRD.—The kingbird appeared to be a rare and irregular summer resident of the Lake Nipigon region. It was seen at Macdiarmid by Mr. N. K. Bigelow during the summer of 1922, and by us during the summer of 1924, but no other records of its occurrence in the region were secured.

♀ June 7, 1924. Macdiarmid.

Sayornis phœbe. PHŒBE.—At least two pairs of phœbes were found near the settlement at Macdiarmid but none were seen elsewhere.

Two nests were discovered, one being situated against the side of a log building and the other against the face of a rock cliff over the water. Both nests contained young.

5 Juv. ? July 7, 1924. Macdiarmid (alcoholic). Juv. ♀ July 12, 1924. Macdiarmid.
♀ July 7, 1924. Macdiarmid.

Nuttallornis borealis. OLIVE-SIDED FLYCATCHER.—This species was well distributed through the stands of black spruce and was consequently more common at the north end of the lake where these woods were more extensive.

While watching an olive-sided flycatcher through the binoculars it was noted that the white tips of the flank feathers are sometimes exposed on each side of the rump from beneath the wing. The song of the species, *whip-whœœ* is a characteristic sound of the desolate spruce forests.

♂ June 27, 1923. Bear creek.

Empidonax flaviventris. YELLOW-BELLIED FLYCATCHER.—These flycatchers were found in many of the moist inland ravines where alders covered the bottom. They were not common but appeared to be well distributed throughout the region.

The song of this flycatcher is suggested by the syllables, *soo-ee*.

♀ June 13, 1924. Macdiarmid.

♂ June 16, 1923. Macdiarmid.

Empidonax trailli alnorum. ALDER FLYCATCHER.—This species was not common but was frequently heard or observed in the alder and willow flats near the lake and along streams.

A pair which behaved as if they were nesting was frequently seen at Cedar creek near Macdiarmid but no positive evidence that they nested there was secured.

Two notes of the species were recorded in the field; one, a *wee-bee*, the second syllable being a slightly ascending slur, and the other, a *be-zœœœœ*, it being an emphatic utterance with the accent on the second syllable and slurred slightly downward.

During a period of about three weeks (the first three weeks in July) the species was silent but later their characteristic notes were again heard.

♂ June 18, 1923. Orient Bay station.

♀ July 24, 1924. Macdiarmid.

2 ♂ July 24, 1924. Macdiarmid.

Empidonax minimus. LEAST FLYCATCHER.—The least flycatcher was the most common representative of its family, being found in all suitable localities visited.

A freshly completed nest was found near Macdiarmid on June 9, 1924. It was situated about twenty feet from the ground in a crotch near the trunk of a paper birch which stood at the edge of an alder thicket. On June 16 the nest contained two fresh eggs and on June 22 the clutch contained four eggs.

♂ June 18, 1923. Orient Bay station. Juv. ? July 21, 1924. Fairloch.
♂ July 11, 1923. Macdiarmid. Juv. ♂ July 23, 1924. Macdiarmid.

Cyanocitta cristata cristata. BLUE JAY.—The species was not common and was seen at only three localities in the region,—Macdiarmid, St. Paul island and McIntyre bay.

♂ June 13, 1924. Macdiarmid.

Perisoreus canadensis canadensis. CANADA JAY.—In the wilder sections Canada jays were frequently met with and on a few occasions they wandered into the clearing at Macdiarmid but did not stay long.

Young of the year were collected, these very probably being reared in the region.

The species was not found to be as fearless and familiar as they are reputed to be in the winter season. In fact they were inclined to be retiring in their habits.

♂ June 25, 1923. Macdiarmid. Juv. ♂ Aug. 5, 1924. Shakespeare island.
Juv. ♀ July 16, 1924. McIntyre bay.

Corvus corax principalis. NORTHERN RAVEN.—Six of these birds were seen near the railway north of Ombabika bay on June 27, 1924. This was the only occasion on which the species was seen by us. Ravens were not known by residents of the region.

Corvus brachyrhynchos brachyrhynchos. CROW.—The crow was more or less common throughout the region.

Nests were found near Macdiarmid but none was seen elsewhere. Young were not seen with the parent birds until the second week of July of both years.

In late July the crows congregated near Macdiarmid and made frequent flights across the bay where they fed on the offal thrown from

the fishing vessels. They also patrolled the boulder-strewn shores near Macdiarmid acting as scavengers for the village.

♀ June 12, 1923.	Macdiarmid.	♀ July 18, 1924.	Macdiarmid.
Juv. ♀ July 18, 1924.	Macdiarmid.	♂ July 18, 1924.	Macdiarmid.
Juv. ? July 18, 1924.	Macdiarmid.		

Molothrus ater ater. COWBIRD.—The male cowbird collected was the only individual seen during the two summers. The species has probably never been established in this heavily wooded region.

♂ June 11, 1923. Macdiarmid.

Xanthocephalus xanthocephalus. YELLOW - HEADED BLACKBIRD.—A single specimen of this species was collected and no others were seen. The individual secured was in breeding condition but it was probably an unmated bird which had wandered slightly out of its normal summer range.

♂ June 20, 1923. Macdiarmid.

Agelaius phoeniceus fortis. THICK-BILLED RED-WING.—The three specimens collected were examined by Mr. Taverner who remarks that they "seem ultra typical of the mid-western form *fortis* of the A.O.U. (Check List) or *arctolegus* of Oberholser".

The species is an uncommon summer resident of the Lake Nipigon region as a whole. The only specimens seen by us which were unquestionably summer residents of the area were a pair at Humboldt bay and a male on the northwest shore of Ombabika bay. Mr. W. J. K. Harkness of the Fisheries Research Laboratory observed the species at the mouth of the Gull river where it appeared to be established in some numbers.

The pair noted at Humboldt bay (June 28, 1924) were breeding birds, the nest having just been completed when found. This was the only pair to occupy a reedy bay covering perhaps one hundred acres.

A specimen taken at Macdiarmid on June 3, 1924, was not an established bird in that locality but a migrant that had not reached its breeding grounds. The migratory movements of many species are not usually concluded along the latitude of the Transcontinental Railway until about the first of June.

♀ June 3, 1924.	Macdiarmid.	♂ June 28, 1924.	Humboldt bay.
♀ June 28, 1924.	Humboldt bay.		

Euphagus carolinus. RUSTY BLACKBIRD.—An injured female was taken at Macdiarmid in 1924 and a flock on their southern migration was seen at Humboldt bay the same year.

No resident birds were seen by us and it seems probable that the species does not breed in the immediate vicinity of Lake Nipigon.

♀ June 2, 1924. Macdiarmid.

Quiscalus quiscula œneus. BRONZED GRACKLE.—This species was seen in early June of both years but after all migratory movements had ceased it was not again noted.

Carpodacus purpureus purpureus. PURPLE FINCH.—The purple finch occurs fairly commonly throughout the region.

Young of the year were collected from flocks which began to be conspicuous after the second week in July.

♂ July 2, 1923. Macdiarmid.

♀ June 7, 1924. Macdiarmid.

♂ July 11, 1923. Macdiarmid.

Im. ♂ July 12, 1924. Macdiarmid.

Juv. ♀ July 18, 1923. Macdiarmid.

Astragalinus tristis tristis. GOLDFINCH.—The species was found to be only fairly common locally. At Macdiarmid, late in the summer, flocks of from six to fifteen individuals were seen during both years.

Pairs were seen in July which behaved as if they were engaged in nesting duties, but no other evidence that this species bred in the region was secured.

♀ July 11, 1924. Macdiarmid.

Spinus pinus. PINE SISKIN.—These birds were seen in small flocks of five or six by the middle of June and as the season advanced the flocks increased in size. These small flocks may or may not have been family groups but collecting from one such group suggests that such was not the case, since three adults were secured.

It would be difficult to state at what season this species breeds since they seem to flock throughout the summer. A young of the year was secured.

Juv. ♂ Aug. 1, 1923. Macdiarmid.

♂ June 14, 1924. Macdiarmid.

2 ♀ June 14, 1924. Macdiarmid.

Passer domesticus. HOUSE SPARROW.—Eleven individuals were known to be resident at Macdiarmid during July, 1923. During the same month in 1924 twenty-six were noted, while the species had also spread to the new clearing about the lumber mill, one and one-half miles north of Macdiarmid. This latter record is of interest since the clearing had been only recently made, the buildings having been erected during the winter of 1923-24.

House sparrows nested in the ventilator cupola of the ice-house at Macdiarmid. The species is likely to increase as other buildings afford nesting sites, and food will be present as long as horses are maintained for the fishing and lumbering industries.

♀ June 18, 1923. Macdiarmid.

♂ July 10, 1924. Macdiarmid.

Poocetes gramineus gramineus. VESPER SPARROW.—The vesper sparrow was not seen in 1923 but two individuals were noted during early June, 1924. In a clearing made during the winter of 1923-24 for a lumber mill all debris had been burned leaving approximately eighty acres of bare field. A singing male was taken there on June 5th.

♂ June 5, 1924. Macdiarmid.

Passerculus sandwichensis savanna. SAVANNAH SPARROW.—The two specimens taken were submitted to Mr. Taverner who says, "These Nipigon birds may tend toward a northern form that has long been suspected. On superficial survey, would not be certain that they are not *savanna*". The Nipigon birds are accordingly tentatively referred to that subspecies.

Single individuals, or pairs, were noted at three localities on the lake.

The behaviour of a pair seen at Ombabika bay on June 25, 1924, suggested the presence of a nest but none was found.

♂ June 25, 1924. Ombabika bay.

♂ July 2, 1924. Orient Bay station.

Passerherbulus lecontei. LECONTE'S SPARROW.—Although this species was looked for it was not seen by us. Koelz (1923) has recorded the capture of a juvenile female taken in a mouse trap at Macdiarmid on July 27, 1922. This record was erroneously attributed to Harris' sparrow by Taverner (1927).

Zonotrichia albicollis. WHITE-THROATED SPARROW.—This was the commonest bird in and about all natural and artificial clearings.

A number of nests were found each summer and it seems that the species is one of the few birds of the Canadian zone which rears more than one brood in a season.

About fifty per cent. of singing white-throated sparrows were heard to prelude their usual song with three short "take-up" notes all on the same pitch and given in rapid succession.

♀ June 14, 1923. Macdiarmid.

♂ July 10, 1924. Shakespeare island.

♂ June 14, 1923. Macdiarmid.

Juv. ? July 16, 1924. McIntyre bay.

♂ July 3, 1924. Macdiarmid.

Juv. ? July 24, 1924. Macdiarmid.

♀ July 8, 1924. Shakespeare island.

♀ July 26, 1924. Orient Bay station.

Spizella passerina passerina. CHIPPING SPARROW.—This was a fairly common bird about inhabited clearings. It was seen on one occasion in a situation far from settlement.

Adults with partly fledged young were frequently seen about our camp at Macdiarmid after the middle of July.

♂ June 25, 1923.	Macdiarmid.	Juv. ? July 17, 1923.	Macdiarmid.
♂ July 4, 1924.	Macdiarmid.	Juv. ♀ July 25, 1924.	Macdiarmid.
♂ July 12, 1924.	Macdiarmid.	Juv. ? July 28, 1924.	Macdiarmid.

Junco hyemalis hyemalis. SLATE-COLORED JUNCO.—Specimens were submitted to Mr. Taverner who remarks that they tend "toward the black-headed *hyemalis* Swarth (1922) found on the Stikine River, B.C.—but are not as decided".

Juncos were not common but were generally distributed being found in the drier clearings and on exposed, rocky hilltops.

A nest with four partly incubated eggs was found on June 26, 1924, at Ombabika bay.

♂ July 7, 1923.	Macdiarmid.	♂ June 9, 1924.	Macdiarmid.
Juv. ? July 11, 1923.	Macdiarmid.	2 ♀ June 26, 1924.	Ombabika bay.
♂ July 11, 1923.	Macdiarmid.	♂ June 27, 1924.	Ombabika bay.

Melospiza melodia juddi. DAKOTA SONG SPARROW.—On comparing a series of thirteen adults from Lake Nipigon with a series from southern Ontario, the former are at once distinguishable by the lack of reddish colour and in having the black markings, especially on the feathers of the back, broader and more intense. The dark markings on the breast are somewhat sharper in outline. Insufficient summer material is at hand for a satisfactory comparison with birds from the prairie provinces but specimens in the collection of Mr. J. H. Fleming from southern Saskatchewan are slightly greyer and exhibit somewhat less black than Nipigon birds. On the other hand specimens from northern Saskatchewan appear to be the same as Nipigon specimens. After a comparison with material from northeastern North Dakota recently added to the Museum's collection, I am convinced that the Nipigon birds should be referred to *juddi*. Mr. Taverner who examined the series states, "These Nipigon birds unmistakably run in with our prairie specimens that I have called *juddi*".

Song sparrows were common in all suitable situations.

Both nests and eggs as well as juveniles were collected.

♀ July 9, 1923.	Macdiarmid.	♂ June 29, 1924.	Humboldt bay.
♀ June 6, 1924.	Macdiarmid.	♂ July 7, 1924.	Macdiarmid.
♂ June 6, 1924.	Macdiarmid.	♀ July 18, 1924.	Macdiarmid.
♂ June 7, 1924.	Macdiarmid.	Juv. ♀ July 19, 1924.	Macdiarmid.
3♂ June 7, 1924.	Macdiarmid.	♀ July 24, 1924.	Macdiarmid.
♀ June 22, 1924.	Ombabika bay.	Juv. ♀ July 30, 1924.	Orient Bay station.
♀ June 23, 1924.	Ombabika bay.		

Melospiza lincolni lincolni. LINCOLN'S SPARROW.—This species was present in many of the clearings, two or three pairs sometimes being found in a partial clearing of not more than two or three acres in extent.

We were not fortunate enough to locate a nest although an adult was seen carrying nesting material. Young just out of the nest, were seen on several occasions, and one was secured.

Males were heard singing occasionally during midday but their usual habit was to sing for a few moments from some low perch just after daybreak and again just before dark. The song suggests the bubbling theme of the house wren but has the unquestionable quality of a finch or sparrow.

♂ June 14, 1923. Macdiarmid.	Juv. ? July 4, 1924. Macdiarmid.
♂ July 6, 1923. Macdiarmid.	2 ♀ July 4, 1924. Macdiarmid.
♂ July 9, 1923. Macdiarmid.	

Melospiza georgiana. SWAMP SPARROW.—This was a common species in suitable situations.

Young just out of the nest were seen on several occasions.

♂ June 27, 1923. Orient Bay station.	Juv. ♀ July 31, 1923. Orient Bay station.
♂ June 21, 1924. Ombabika bay.	♂ July 23, 1924. Macdiarmid.

Hedymeles ludovicianus. ROSE-BREADED GROSBEAK.—A male taken at Macdiarmid was the only record of the occurrence of the species in the region.

♂ June 10, 1924. Macdiarmid.

Iridoprocne bicolor. TREE SWALLOW.—This swallow was fairly well distributed throughout the region but was not particularly common in any locality.

Two nests were found at Macdiarmid, both located in abandoned woodpecker holes in dead trees near the water.

♂ June 14, 1923. Macdiarmid.

Bombycilla cedrorum. CEDAR WAXWING.—Flocks of from ten to twenty individuals were regularly seen until the last of June when they separated into pairs.

Although no nests were found, young birds were observed in late July and early August.

♂ June 18, 1923. Macdiarmid.	♂ Aug. 8, 1924. Humboldt bay.
♂ July 31, 1924. Macdiarmid.	

Vireosylva olivacea. RED-EYED VIREO.—This species was common throughout the poplar growths of the region.

A nest containing two newly hatched young and two eggs was found on July 18, 1923.

♂ June 13, 1923. Macdiarmid.

♂ July 18, 1924. Macdiarmid.

♀ June 22, 1924. Ombabika bay.

Vireosylva philadelphia. PHILADELPHIA VIREO.—To judge from the number of occasions on which it was positively identified this species appeared to be almost as common as the red-eyed vireo.

A pair was observed carrying nesting material on June 19, 1923.

The song was distinguishable from that of *olivacea*, being about a musical fifth higher in pitch with a slightly longer pause between phrases.

♀ June 19, 1923. Orient Bay station.

♂ June 21, 1924. Ombabika bay.

♂ June 9, 1924. Macdiarmid.

Lanivireo solitarius solitarius. BLUE-HEADED VIREO.—This species was not infrequently met with in the mixed forest.

♂ June 27, 1923. Bear Creek.

♂ June 9, 1924. Macdiarmid.

Mniotilta varia. BLACK AND WHITE WARBLER.—This warbler was common in many localities visited.

2 ♂ June 11, 1923. Macdiarmid.

♂ June 9, 1924. Macdiarmid.

♀ June 4, 1924. Macdiarmid.

Vermivora ruficapilla ruficapilla. NASHVILLE WARBLER.—This was another common species, well distributed throughout the region.

It doubtless breeds throughout the area. Young being fed by the parents were observed on several occasions late in July at Macdiarmid.

♂ June 9, 1924. Macdiarmid.

2 Juv. ♀ July 18, 1924. Macdiarmid.

♀ June 24, 1924. Ombabika bay.

2 ♂ July 18, 1924. Macdiarmid.

Vermivora celata celata. ORANGE-CROWNED WARBLER.—A few pairs were noted at Ombabika bay but the species was not observed elsewhere.

Its song is a musical trill not unlike that of the junco but sufficiently different to attract one's attention to the bird.

♂ June 24, 1924. Ombabika bay.

Vermivora peregrina. TENNESSEE WARBLER.—This was a common species throughout the region, found foraging through all types of forest growths.

A nest containing four incubated eggs was collected on July 21, 1924. It was composed of dry grasses and situated in the side of a clump of sphagnum moss slightly elevated above the surrounding bog. This nest which was taken by Mr. Baillie appears to be the first collected in Ontario.

The song of this species is an accelerated *cut-sic, cut-sic, cut-sic, cuwitcha, witcha, witcha, witcha, see-see-see-see-see*. A male collected on July 16, 1923, has a fairly evident crown patch of chestnut-brown, like that of *ruficapilla*. Such a marking is unusual but has been previously reported by Lloyd (1917).

♂ July 16, 1923. Macdiarmid.

♀ July 19, 1924. Macdiarmid.

♂ July 17, 1923. Macdiarmid.

♀ July 21, 1924. Fairloch.

♂ June 5, 1924. Macdiarmid.

Dendroica tigrina. CAPE MAY WARBLER.—A single singing male taken on Shakespeare island is the only record of the species in the region.

♂ July 8, 1924. Shakespeare island.

Dendroica æstiva æstiva. YELLOW WARBLER.—This warbler was not common at Lake Nipigon, only a few birds having been seen at scattered localities.

The species breeds in the alder- and willow-covered flats of both the mainland and the islands. Young birds were seen being fed by the parents.

♀ July 31, 1923. Orient Bay station.

♀ July 14, 1924. Gros Cap.

♂ June 20, 1924. Ombabika bay.

Dendroica coronata. MYRTLE WARBLER.—This warbler was not common in the region as a whole but in one or two localities it was seen in some numbers.

The species breeds in the region, partially fledged young having been secured.

♂ June 21, 1923. Naonan island.

♀ Aug. 5, 1924. Shakespeare island.

♂ July 16, 1924. McIntyre bay.

Juv. ? Aug. 8, 1924. Humboldt bay.

♂ Aug. 1, 1924. Macdiarmid.

Juv. ? Aug. 9, 1924. Humboldt bay.

Dendroica magnolia. MAGNOLIA WARBLER.—This was the most abundant and generally distributed warbler and at times appeared to be the most common bird of the region.

The species breeds throughout the area, families of noisy young being frequently met with during late July.

♀ June 14, 1923. Macdiarmid.

Juv. ? July 24, 1924. Macdiarmid.

♂ June 9, 1924. Macdiarmid.

♂ July 24, 1924. Macdiarmid.

***Dendroica pensylvanica*. CHESTNUT-SIDED WARBLER.**—

This warbler was common in three locations along the southern end of Lake Nipigon but was not recorded from any of the stations at the northern end of the lake. This observation appears to indicate that this characteristic species of the Transition zone reaches its northern limits at Lake Nipigon.

- ♂ June 11, 1923. Macdiarmid. ♂ July 23, 1924. Macdiarmid.
♂ July 2, 1924. Orient Bay station.

***Dendroica castanea*. BAY-BREASTED WARBLER.**—This was a fairly common species of the region.

The song of the bay-breasted warbler is very similar to the notes of the golden-crowned kinglet but is composed of five whispered notes instead of three.

- ♂ June 5, 1923. Macdiarmid. ♂ July 8, 1924. Shakespeare island.
♂ June 27, 1923. Bear creek. ♀ July 16, 1924. McIntyre bay.
♀ July 4, 1923. Macdiarmid. ♀ Aug. 8, 1924. Humboldt bay.

***Dendroica fusca*. BLACKBURNIAN WARBLER.**—This warbler was not very common at Lake Nipigon.

A family of young was observed at Macdiarmid in 1923 and partly fledged young were secured in 1924.

- ♂ June 28, 1923. Macdiarmid. ♀ July 24, 1924. Macdiarmid.
♂ July 23, 1924. Macdiarmid. Juv. ? Aug. 9, 1924. Humboldt bay.
Juv. ♀ July 24, 1924. Macdiarmid.

***Dendroica virens*. BLACK-THROATED GREEN WARBLER.**—This was a common species of the mixed forest.

Young were observed being fed by the adult.

- ♂ July 2, 1923. Macdiarmid. Juv. ? July 25, 1924. Macdiarmid.
♂ July 8, 1924. Shakespeare island. Juv. ♂ Aug. 3, 1924. Macdiarmid.

***Seiurus aurocapillus*. OVEN-BIRD.**—This species was fairly common in the mixed forest.

A partly fledged young, just out of the nest, was secured at McIntyre bay in 1924.

- ♂ June 11, 1923. Macdiarmid. ♂ July 25, 1924. Macdiarmid.
♂ July 12, 1924. Macdiarmid. Juv. ♀ July 26, 1924. Orient Bay station.
Juv. ? July 16, 1924. McIntyre bay. ♂ July 26, 1924. Orient Bay station.
♀ July 21, 1924. Fairloch.

***Seiurus noveboracensis notabilis*. GRINNELL'S WATER-THRUSH.**—The single specimen secured agrees well with the colour

distinctions of *notabilis*; in fact it is more typical of that form than birds from farther west with which it was compared.

Water-Thrushes were rather uncommon being heard at only a few places on the lake, and they were seldom seen.

♂ June 25, 1924. Ombabika bay.

Oporornis agilis. CONNECTICUT WARBLER.—This species was seen only at Ombabika bay where two singing males were noted in a black spruce growth.

The song was a loud *ca, chicka-chicka, chicka-chicka, chicka-chicka*, reminding one of the song of the Maryland yellow-throat.

♂ June 27, 1924. Weatherbe.

Oporornis philadelphia. MOURNING WARBLER.—This was a common species of the clearings. The number of these birds was particularly striking, a feature also noticed by Dr. Koelz during his stay on the lake in 1922.

A nest with a partial set of eggs was found at Macdiarmid on June 29, 1923, but it was destroyed before the set was completed. A young bird just out of the nest was collected.

Breeding males show a great variation in the amount of black on the upper breast and throat. It appears, from specimens secured, that as the season advances and the feathers become worn the black extends from the upper breast to the base of the bill. A male collected on July 11, 1924, which showed by dissection that it was in breeding condition had a few black and yellowish feathers on the throat while the breast was similar to that of a female.

♂ June 13, 1923.	Macdiarmid.	2	♂ July 23, 1924.	Macdiarmid.
♂ July 11, 1924.	Macdiarmid.		Juv. ♀ July 24, 1924.	Macdiarmid.
♂ July 12, 1924.	Macdiarmid.		♂ July 28, 1924.	Macdiarmid.
♀ July 16, 1924.	McIntyre bay.		♀ Aug. 2, 1924.	Macdiarmid.
♀ July 23, 1924.	Macdiarmid.			

Wilsonia pusilla pusilla. WILSON'S WARBLER.—At the time of our arrival at Macdiarmid on June 2, 1924, migratory movements had not yet ceased. Wilson's warbler was one species which was taken at Macdiarmid during the first week of June and then disappeared from the southern end of the lake. The species was rare in the region as a whole, but a few were noted on the northwest shore of Ombabika bay late in June.

No positive evidence as to whether the species breeds in the locality was secured.

2 ♀ June 7, 1924. Macdiarmid.

♂ June 22, 1924. Ombabika bay.

Wilsonia canadensis. CANADA WARBLER.—This common warbler was noted in heavily wooded situations and also in partially overgrown clearings.

A partially feathered young was taken.

♂ June 14, 1923. Macdiarmid. Juv. ♂ July 25, 1924. Macdiarmid.
♂ June 10, 1924. Macdiarmid.

Setophaga ruticilla. REDSTART.—This species was common at all points visited.

Both nests and young were observed.

The song of the redstart was variable. One individual which sang from the same general location at the edge of the clearing at Macdiarmid repeated incessantly an ascending, hissing trill.

♀ June 5, 1924. Macdiarmid. Juv. ♂ July 31, 1924. Macdiarmid.
♂ June 18, 1923. Macdiarmid. ♀ July 31, 1924. Macdiarmid.
♂ July 23, 1924. Macdiarmid.

Troglodytes ædon parkmani. WESTERN HOUSE WREN.- - The skin of a male specimen has been compared with eastern and western birds and it is strikingly greyer than those from the east. Mr. Taverner confirms the opinion that it is well marked *parkmani*. But one pair of house wrens was noted during the two summers.

This pair was nesting about the debris from an old railway construction camp of the railway, east of Weatherbe.

♂ June 27, 1924. Weatherbe.

Nannus hiemalis hiemalis. WINTER WREN.—This species was well distributed throughout the region being found for the most part in the darker ravines and in dense cedar growths with fallen trees.

♂ June 28, 1923. Macdiarmid ♂ July 22, 1924. Macdiarmid.

Certhia familiaris americana. BROWN CREEPER.—This was not a common species but it was seen at three localities in the southern part of the area.

A partly fledged young was collected with the parent female at Shakespeare island.

Juv. ? July 14, 1923. Macdiarmid. ♀ July 8, 1924. Shakespeare island.
Juv. ? July 8, 1924. Shakespeare island. ? Aug. 4, 1924. Shakespeare island.

Sitta canadensis. RED-BREASTED NUTHATCH.—This species was not infrequently observed in stands of mixed forest where occasional dead tree trunks were standing.

The species breeds in the region, adults having been seen on several occasions carrying food into old woodpecker holes high up in dead trees.

♀ July 2, 1923. Macdiarmid. ♂ July 10, 1924. Shakespeare island.

Penthestes atricapillus septentrionalis. LONG-TAILED CHICKADEE. Adults secured were long-tailed birds lacking ochraceous colour on their backs. Mr. Taverner who examined the specimens agrees that they are referable to the subspecies *septentrionalis*.

Chickadees were fairly common in the region.

A nest was found on June 7, 1924 in an abandoned woodpecker hole near the top of an eight foot stump standing in shallow water. Family groups were frequently seen by the second week in July.

♂ June 11, 1923. Macdiarmid. Juv. ♀ July 11, 1924. Macdiarmid.
 ♂ July 19, 1923. Macdiarmid. Juv. ♂ July 11, 1924. Macdiarmid.
 Juv. ? July 11, 1924. Macdiarmid.

Penthestes hudsonicus hudsonicus. HUDSONIAN CHICKADEE.—This chickadee was an uncommon species having been observed at but two widely separated localities.

Young were collected from families foraging through a dense, wet woods near Macdiarmid.

The notes of this species are similar to those of the other chickadee of the region but are hoarser and have a buzzy quality.

Juv. ? July 9, 1923. Macdiarmid. Juv. ♂ July 22, 1923. Macdiarmid.
 ♀ July 9, 1923. Macdiarmid.

Regulus satrapa satrapa. GOLDEN-CROWNED KINGLET.—This was a common bird of the mixed woods where conifers predominated. A partially fledged young was secured.

♀ July 14, 1923. Macdiarmid. ♂ July 23, 1924. Macdiarmid.
 ♂ June 27, 1924. Weatherbe. Juv. ♂ July 28, 1924. Macdiarmid.
 ♂ July 10, 1924. Shakespeare island.

Regulus calendula calendula. RUBY-CROWNED KINGLET.—This was an uncommon species. It was not seen during 1923 and at only one locality in 1924.

♂ June 25, 1924. Ombabika bay.

Hylocichla ustulata swainsoni. OLIVE-BACKED THRUSH.—A specimen collected on June 24, 1924 at Ombabika bay is distinctly gray above, a similar bird to those mentioned by Taverner (1919) in "The Birds of Shoal Lake, Manitoba". All the other specimens are normal *swainsoni*.

This thrush was common throughout the region but was principally found in the mixed woods, although during the season when raspberries were ripe it frequented the clearings to feed on this fruit.

On June 23, 1924, a nest containing four fresh eggs was found at Ombabika bay. It was situated eighteen inches from the ground in a young spruce. The eggs were left untouched for two or three days to make certain that the clutch was complete but in the meantime the bird deserted the nest and one egg disappeared. Similar experiences have been recorded by other observers and few appear to be satisfactorily explained.

♂ June 11, 1923. Macdiarmid. Juv. ? July 16, 1924. McIntyre bay.
 ♂ June 22, 1924. Ombabika bay. ♀ July 16, 1924. McIntyre bay.
 ♀ June 24, 1924. Ombabika bay. ♂ July 18, 1924. Macdiarmid.

Hylocichla guttata pallasii. HERMIT THRUSH.—This thrush was not nearly so common as the preceding and was seen in only three localities. It was found in drier situations.

♂ July 7, 1923. Macdiarmid. ♂ June 26, 1924. Ombabika bay.
 ♀ June 24, 1924. Ombabika bay. ♂ July 16, 1924. McIntyre bay.

Planesticus migratorius migratorius. ROBIN.—The robin was not common but was generally distributed, a pair having been found in almost all of the settled clearings visited, while individuals were noted also in situations far removed from settlement.

A pair nested in the clearing at Macdiarmid, and a set of eggs was taken near the Transcontinental Railway north of Ombabika bay on June 27, 1924. In this instance the nest was situated on the top of a stump about eighteen inches from the ground in a partial clearing many miles from a settlement.

♂ June 23, 1923. Macdiarmid.

LITERATURE CITED

- Koelz, W. 1923. Some recent records from the Lake Superior region, Ontario. *Can. Field-Naturalist*, **37**: 118.
 Lloyd, Hoyes 1917. Ontario bird notes. *The Auk*, **34**: 460.
 Snyder, L. L. 1924a. Peculiar behavior of the spotted sandpiper (*Actitis macularia*). *The Auk*, **54**: 341-342.
 Snyder, L. L. 1924b. On the crown markings of immature hairy and downy woodpeckers. *Can. Field-Naturalist*, **37**: 167-168.
 Swarth, H. S. 1922. Birds and mammals of the Stikine river region of northern British Columbia and southeastern Alaska. *Univ. Calif. Pub. Zool.*, **24**: 243.
 Taverner, P. A. 1919. The birds of Shoal lake, Manitoba. *Can. Field-Naturalist*, **33**: 19.
 Taverner, P. A. 1927. Some recent Canadian records. *The Auk*, **44**: 225-226.

THE AMPHIBIANS AND REPTILES OF THE LAKE NIPIGON REGION

By E. B. S. LOGIER

In the summers of 1921, 1922 and 1924, the writer visited Lake Nipigon in the capacity of artist to the Fisheries Research Laboratory, Department of Biology, University of Toronto, and it was in those summers, chiefly, that the material and data used in the present paper were collected. Considerable material was also collected by other members of the Fisheries Research Laboratory and of the Royal Ontario Museum of Zoology, especially in the years when the writer was not at Lake Nipigon.

The list presented in the following pages is probably incomplete but this represents the first serious attempt to make a herpetological survey of the region. The only previous list of amphibians and reptiles of this region known to the writer is that of Wilson (1910) who included some faunistic lists in his report on the Geology of the Nipigon Basin. His account is as follows:

"Reptiles: Specimens of the Mud Puppy, *Necturus maculatus*, and at least two species of salamander, were seen. Several species of toads and frogs occur, but the common frog of more southern parts of Ontario is rare.

"Garter snakes are occasionally seen, and seem to be the only kind of snake found in the district. According to the Indians, a species of tortoise, probably *Chremy* sp., occur on a small lake, the first west of Black Sturgeon Lake on the Circle Lake System."

Of the forms recorded in the above list, *Necturus maculosus* was not seen by any of the University of Toronto party during the six summers spent in careful and detailed study of Lake Nipigon and its fishes, so if correctly identified by Wilson, it is evidently of rare occurrence. Mr. Duncan Bell reports seeing it once at McIntyre bay.

Amphibians are fairly well represented at Lake Nipigon, nine species having been found,—three urodeles and six anurans, and most of them were fairly common. Of the reptiles only two species were found,—Bell's turtle and the common garter snake, neither of which was plentiful.

Comparison of the amphibian fauna of the main shores of Lake Nipigon with that of the islands is interesting, since the latter have evidently been isolated since the retreat of the last glacier, precluding

the possibility of voluntary migration of adults or larvae as this would necessitate, in some cases at least, a swim of several miles in the open lake. All of the species of amphibians found on the islands, viz., Jefferson's salamander, American toad, wood frog, green frog, and leopard frog are species which lay their eggs in strings or masses of jelly either floating free or attached to, or tangled about trash in the water. Eggs laid in this manner might easily be transported by floating, especially if they were attached to any buoyant objects. It is also possible that adult salamanders hibernating in old logs about the margins of streams might be carried out with the high water in the spring, and logs containing them might occasionally reach an island.

The eggs of the newt and the peeper are laid singly, those of the latter species free on the bottom, those of the former folded in the leaves of aquatic plants which are anchored and pliable, and unlikely to become uprooted by current or wave action in the quiet situations which the species selects. These two species seemed to be absent from any of the islands investigated. It is interesting to note in this connection that newts and peepers were not found about the shore waters of Lake Nipigon, even in the most sheltered bays, but resorted to small bodies of impounded water.

The association of amphibian larvae with each other and with fish is to a certain extent restricted by the nature of habitat required by the different species. *Ambystoma* larvae were not found in company with fish, which is also true of *Triturus*. *Ambystoma* and *Triturus* were found together and in company with tadpoles of *Hyla crucifer* and *Rana clamitans*. *Ambystoma* larvae were also found in water with *Bufo americanus* and *Rana catabrigensis* tadpoles. Tadpoles of *B. americanus*, *H. crucifer*, *R. cantabrigensis*, and *R. clamitans* were found together in the same water.

Except in one case, the tadpoles of *H. crucifer* were not found in company with fish, and in this case the fish in question were young brook sticklebacks and small minnows of one or more species.

LOCALITIES

Owing to the fact that many of the small lakes and streams in the region of Lake Nipigon have no official names, it is necessary to coin names by which to refer to them. A number of these waters are referred to and discussed in Dymond's paper, "The Fishes of Lake Nipigon", (1926), and the names which he used there will be employed in the present paper, a few more being added.

The following is a list of some of the habitats with brief descriptions of physical characters. Of these, Centre lake, Crescent lake, First Station lake, Orient bay and Pustagone river have been described by

Dymond and some of his data will be included in the following descriptions.

Centre and Crescent lakes lie in the same valley and are separated from each other by a low, marshy area. Crescent lake, the source of Cedar creek, is crescent-shaped, and about 200 yards long by 75 yards wide. The water of these lakes is dark brown, the bottoms are of muck, and the shores, except on the western side, are largely of sphagnum bog. Centre lake is the deeper of the two. The water in Crescent lake is apparently not deeper than three feet.

Muskeg lake lies at the foot of the eastern slope of the hill at Fairloch upon which stands the fire rangers' lookout tower, about three miles north of Macdiarmid. Its greatest length is probably not much more than 100 yards. The shores are of quaking bog, the bottom of muck, and the water is turbid-brown. At the north end there is a sphagnum bog forested with black spruce.

Newt lake is a small lake of irregular shape, with several bays, and not much over a half mile in greatest length. It is situated on a plateau among the hills on the west side of Orient bay, just across from Macdiarmid, and about 250 or 300 feet above Lake Nipigon. It is forested to the water's edge around most of its shores. The bottom is chiefly of mud, but rather firm and stony along much of its southern edge. The west end is shallow and marshy, sustaining a good growth of sphagnum and sedges. A bay at the eastern end narrows to an outlet, and the bottom here is strewn with decaying leaves of alder and poplar. The water is clear.

Orient Bay lake is a small lake about 100 yards in width, near the south end of Orient bay. It lies at the foot of a cliff which forms its eastern shore. The cliff has a rock talus at its base running down to the water. The other shores are low and fringed with speckled alder, and the bottom, at least at the southeastern part, is sandy for a few yards out and then becomes oozy.

First Station lake, situated about a mile northeast of Macdiarmid, lies in a deep valley between two ridges. It is about a half mile long and 150 yards wide, with a sphagnum bog at each end. The sides are rather steeply sloping and forested to the water's edge, except for a short distance where a rock talus forms the shore. The bottom is mostly of soft ooze, though firm and sandy at parts of the shore. The water reaches a depth of six feet and is somewhat brownish. The lake drains by a small stream which enters Orient bay at Macdiarmid.

Second Station lake lies in the next valley east of First Station lake. It is smaller than the latter. Its shores are margined by a narrow bog which is closely surrounded by the forest, and the bottom is of soft ooze.

Toad Pond and Pustagone ponds. In the partly dry bed of a side channel near the mouth of the Pustagone river, was a large, shallow pond with mud bottom sloping gently down to a depth of about twenty inches. In some of the shallow places there was a good growth of short, submerged grass, while other aquatic plants such as *Potamogeton*, *Utricularia* and yellow pond lilies grew in the deeper parts. It was unshaded and the water became warm on sunny days. Near this "Toad pond" as it shall be called, were some smaller ponds in the same channel bed and in a smaller channel entering it.

C.N.R. pools. Along the sides of the Canadian National road-bed, from a short distance north of Macdiarmid to near the Pustagone river valley, were a number of shallow pools which in rainy weather would drain through each other forming a small stream, but would dry down and separate in dry weather, some of them finally losing all of their water, others retaining some. In some parts of these pools sedges and rushes were growing, in other places the bottom was of bare mud without vegetation of any kind. In some places the water would reach a depth of a foot or more and seemed to be permanent.

Orient bay (Pijitawabic bay), at the southeast corner of Lake Nipigon is about ten miles in length, and narrows gradually southward to a point. At the southern end which is well removed from the influence of the lake and sheltered on both sides by high hills, the water is shallow and quiet and there is much aquatic vegetation. Here are some ponds cut off from the bay by the railroad embankment.

The Pustagone river enters Orient bay about a mile south of Macdiarmid. Much of the bed is stony and the water is, in most places, rather shallow and rapid. Near the mouth the stream forks, but reunites a few hundred feet from the lake, and here the valley is a wide, grassy flat, devoid of trees.

MEASUREMENTS

Measurements of the total length of frogs are taken from the tip of the snout to the anus, and those of the hind legs from their insertion in the pelvis to the ankle joint, not to the heel. It was found that measurements taken to the heel varied somewhat depending on whether

the foot was bent at an angle or drawn out straight. All proportionate measurements are given in percentages of the total length. All measurements were made from preserved specimens.

In the case of the amphibians, discussion of structure and colour are not entered into except where interesting variations from normal occur.

ACKNOWLEDGEMENTS

My thanks are due to Dr. A. H. Wright of Cornell University for his kindness in examining and reporting on specimens sent to him, and furnishing many interesting comments on variation in the different species in question; also to Dr. A. G. Ruthven, Museum of Zoology, University of Michigan, who examined the garter snakes.

AMPHIBIANS

Triturus v. viridescens (RAF.). GREEN NEWT.—This species was found to be common in some of the small lakes southeast of Lake Nipigon, but it was not found in any of the bays or marshes of Lake Nipigon itself. It was found in greatest numbers in Newt lake which was visited in July, 1922, 1923 and 1924, and on each occasion this lake contained very large numbers of newts. The species was seen in fair numbers in Orient Bay lake in June 1924, and one specimen was taken at Second Station lake in July of the same year. It appeared to be totally absent from any of the islands investigated.

The life history in this latitude is deserving of some careful study and would be interesting to compare with that in more southern localities.

On June 12, 1924, a few males were noted clasping females in Orient Bay lake. On the occasion of the visits to Newt lake in July of three consecutive years no eggs or larvae were found. Egg-laying evidently lasts far into the summer as most of the females examined from the July collections contained ripe ova in varying numbers. The apparent absence of even the smallest larvae in the water at this time of the year would also suggest a late beginning of egg-laying. These facts, when compared with the observations of Gage (1891) and Pope (1924) and considered together with the shortness of the northern summer, would suggest the probability, especially in the case of eggs laid as late as the end of July, of a protracted larval life with metamorphosis delayed till early in the following summer. In that case one would not expect to find many larvae in the water in July.

The smallest specimens collected were three males of 61.3, 63.0 and 65.7 mm. in length, and two females of 66.5 and 67.6 mm. in length.

These five specimens which were taken in the water, and showed no more than a trace of the ventral black spotting of the adult, are remarkably small for the terrestrial form returning to the water. Pope (1924) after measuring 800 aquatic newts from twenty-seven different collections in various parts of the northeastern United States, found the minimum to be 71 mm. Measurements of 284 specimens of the land form by the same author show the average to be 62.62 mm., with a maximum of 100 mm.

A total of 140 specimens was taken at Lake Nipigon, of which 85, or 60.7 per cent. were males. Most of these showed only a moderate or poor development of the tail fin and of the horny ridges on the hind legs. The cloacal villi were mostly well developed, as were also the facial pits. The testes showed great variation both in size and shape, and were relatively larger in animals of less than 87.0 and over 106 mm.

Most of the specimens taken were of normal colouration, but a few were unusually dark.

Ambystoma.—Two species of this genus, *A. jeffersonianum* and *A. maculatum* were found.

Larvae were found in four localities differing considerably in their physiographic conditions, as follows: In the C.N.R. pools south of the tunnel near Macdiarmid; in some small permanent ponds close to the Toad pond near the mouth of the Pustagone river; in Newt lake and in Muskeg lake.

Salamanders were very generally absent from the islands of the lake, the single specimen of *A. jeffersonianum* referred to below being the only island record.

The spawn of *Ambystoma*, was not found, nor the spawning dates of either species noted. Records of stages of larval development at different dates and localities are as follows: On June 28, 1921 larvae ranging from 25 to 35 mm. in length were taken in the C.N.R. pools south of the tunnel near Macdiarmid; on July 24, 1921 full grown larvae with gills absorbed to stubs were taken in Muskeg lake; on July 13, 1924 two specimens of less than 24 mm., and with large gills were taken in a pond near the mouth of the Pustagone river; on July 21, 1924 larvae varying from 35 to 49 mm., all with large gills were taken in Muskeg lake.

***Ambystoma jeffersonianum* (GREEN).** JEFFERSON'S SALAMANDER.—This species was the commoner of the two, though not abundant. Ten adults were taken, eight at the southern extremity of Orient bay, one on top of a hill at Fairloch (at the fire rangers' lookout tower) and one on Shakespeare island.

The specimens from Orient bay were found under drift on the beach

and around the shores of some ponds close to the beach, in July 1923 and June 1924. The Shakespeare island specimen was taken by Mr. J. L. Hart in June 1926. The specimen from the hill at Fairloch was taken by Mr. Dan Kerr in a small well on Aug. 7, 1921. The summit of this hill is exposed and dry, and sometimes becomes very hot under the mid-day sun. The slopes, though forested, are well drained and dry, especially on the east side which descends rather steeply with much exposed rock. The nearest body of water is Muskeg lake at the foot of the east slope where larvae were found.

All of the adults were young ones ranging in length from 73.5 to 110.5 mm. Their colour was quite normal for young *A. jeffersonianum*.

Ambystoma maculatum (SHAW). SPOTTED SALAMANDER.

—Three specimens were taken by Mr. Dan Kerr in the well on top of the hill at Fairloch, where the specimen of *A. jeffersonianum* referred to above, was found. The dates of capture were June 7, 8, and 30, 1922. The specimens measured respectively 139, 92 and 130 mm. and were quite normal in colouration.

Bufo americanus HOLBROOK. AMERICAN TOAD.—This species was common at Lake Nipigon. It was taken on the main land at Ombabika bay, Sturgeon river, Cedar creek, Macdiarmid, Pustagone river, Orient bay and McIntyre bay, and on four of the islands, Murchison, Shakespeare (Main island), Naonan, and on a small island close to St. Paul island.

It was scattered generally over a variety of country,—in light dry woods, about clearings, in river valleys, around sheltered bays and was seen once at First Station lake. It was common in the clearing about the village of Macdiarmid and on the Canadian National Railway right-of-way, breeding in the pools beside the track. It was found in considerable numbers near the mouth of the Pustagone river where the deep valley is wide and flat and clear of forest. At Ombabika bay it was taken in the clearing about the Revillon Frères buildings. Those taken at Sturgeon river were in the water at the edge of a clearing.

The toads in their wanderings showed the usual preference for moderately dry situations about clearings and in light, second growth woods. They were very scarce in the forest, a single specimen being taken in a forest of tall pines at McIntyre bay.

The specimens collected were exceedingly variable, especially in certain characters of the head. Five specimens examined by Dr. A. H. Wright, and shown by him to Dr. Remington Kellogg, were returned with the following comments: "A very variable lot, showing strong variation toward some three or four species or varieties".

In one of these specimens there were no supratympanic nor post-orbital crests and the tympanum was large. In another the temporal crests resembled those of *B. hemiophrys*, while the tympanum was small. In two others the supratympanic crests were absent, the post-orbitals were in contact with the paratoids as in *B. fowleri* and the tympanum was large. Only one specimen was a normal *B. americanus*.

In general, the colour of the Nipigon toads was typical for northern *B. americanus*, with red as a strong note in a good many individuals. The males were usually more greenish or yellowish than the females and with less contrast in the dark mottling. Red was more frequently noted in the colour of the females, though occasional males showed a pronounced reddish hue, especially about the head and shoulders.

Evidence was obtained which indicated that the species bred in the quiet parts of rivers, in permanent ponds, in rocky shore pools maintained at level by the lake, in spring-fed pools, in temporary pools and in bays of the lake.

In 1924 spawning was observed at the Toad pond at the Pustagone river on June 5, and was evidently just commencing, as the strings of jelly were apparently fresh, having gathered no silt, and the eggs showed no signs of segmentation visible to the naked eye.

On June 14 numerous tadpoles of six to seven millimetres in length were found clinging to grasses close to the remains of the disintegrating spawn, much of which had failed to hatch.

By July 28 transformation was complete and no tadpoles were left in the water, but newly transformed toads were numerous on the shores of the pond, and in all those seen, except one, the tails were completely absorbed.

The period from the beginning of egg-laying till the beginning of metamorphosis in this pond was evidently about forty-six days. A development period of approximately the same length was noted in another pool observed concurrently.

Hyla crucifer WIED. SPRING PEEPER.—To judge by the evening and night choruses, *H. crucifer* was by far the most abundant amphibian in the district, although, owing to its small size and shy and secretive habits, specimens were not often seen. Records were obtained from McIntyre bay, Orient bay, Pustagone river, Macdiarmid, Newt lake, Muskeg lake, First Station lake, Second Station lake, Crescent lake, and West bay. The species was in general plentiful where small bodies of impounded water occurred, but was rarely found about the shores of Lake Nipigon itself, which were probably too exposed to be attractive. It was apparently absent from the islands of the lake.

The specimens collected ranged from 18 to 29.5 mm. in length, and were quite typical in colouration.

The tadpoles were found only in ponds and small lakes, never in rivers nor in bays of Lake Nipigon. They were taken in Muskeg lake, Newt lake and Second Station lake, and from the Toad pond at the Pustagone river.

The date of the beginning of spawning was not determined. The earliest date on which tadpoles were found was June 14, 1924, when three very young specimens of less than 6 mm. were secured along with other species at the Toad pond, Pustagone river. By June 21 they were plentiful and ranged from 7 to 14.5 mm. By July 30 metamorphosis was well under way and many of the young frogs with large, or partly absorbed tails were hopping about the margins of the pond. The great range of size seen among the tadpoles on any given date would indicate a long spawning period for the species.

Rana cantabrigensis BAIRD. NORTHERN WOOD FROG.—This frog was found to be very common both in wet woods and in more open country where water was available. It was taken on the main land at Ombabika bay, Onaman river, Sandy river, Crescent lake, Centre lake, First Station lake, Second Station lake, Macdiarmid, Pustagone river, Orient bay, Newt lake, McIntyre bay, Black Sturgeon bay, Gull bay, and West bay. It was taken also on Murchison and Shakespeare islands, and was plentiful at Shakespeare Island lake. Next to *Hyla crucifer*, it was the most abundant amphibian.

In general the coloration of the specimens collected was very similar to that of *R. sylvatica*, except that a few showed the white line down the middle of the back and along the upper surfaces of the hind limbs. In some this line was only faintly evident.

The largest specimen measured 51 mm., and the average for thirty-two adults was 42.17 mm. The hind limbs showed great variation in length. Measurements of thirty-two adults give an average of 87.72 per cent. of the total length of head and body, with a maximum of 97.4 and a minimum of 77.46 per cent., a variation of almost 20 per cent. of the total length of the animal.

The eggs of this frog were not found, nor the date of egg laying determined. It is evidently the earliest spawner, as tadpoles half an inch in length were found on June 5, 1924 in a small pond near the Toad pond. By Aug. 2, transformation was in progress, but most of the young frogs still possessed their full tadpole tails and had not yet left the water.

In one of the C.N.R. pools at Macdiarmid, transformation was still

further advanced on this date, and a number of the young frogs were about on the shore with their tails fully absorbed.

R. cantabrigensis was the only amphibian found commonly in the coniferous woods. Where the floor of the woods was wet and covered with sphagnum, these frogs were often seen about the small water holes numerous in such situations.

***Rana clamitans* LATREILLE. GREEN FROG.**—This species was fairly common, but less so than the wood frog. It was taken at Muskeg lake, and at another small lake farther inland at Fairloch, at Centre lake, Second Station lake, Macdiarmid, Pustagone river, Orient bay, Newt lake and South bay. The island records are from Shakespeare island and a small island near Gros Cap.

In coloration the green frogs of the Lake Nipigon region were sombre and dark. The bright green of head and shoulders, so characteristic of the species in more southern localities, was not seen in any of the specimens examined. A dull ground colour of medium to dark olive brown on the upper parts, with darker spots or blotches on the back and bands on the hind limbs was the usual condition. A few individuals were of a dull grayish green. Some of the specimens collected showed a tendency towards a still darker and unusual type of colouration, in the extreme of which, the upper parts were dark blackish brown with small irregular isolated spots of soiled straw-colour. A series of eleven specimens tending towards this type of colour and pattern showed a fairly well graded sequence of steps between it and the normal. This reversal of the normal colour plan in the adult was associated with a similar condition in the tadpole, in which the ground colour above was dark brown with small isolated spots of metallic green. The largest adult measured 84 mm. in length.

The tadpoles were found in streams, ponds and small lakes. They were taken in a small creek at Macdiarmid, in a cool stream at South bay, in the Toad pond, in Newt lake, Centre lake and Second Station lake, and were seen in large numbers in a pond at the south end of Orient bay. They were plentiful in Shakespeare Island lake.

No definite information on breeding activities was obtained. A number of vociferous and very active males was seen in the Pustagone ponds on June 14. This was the first voice record. A female taken at these ponds on June 7, contained a fair number of ripening eggs, and another specimen taken here on June 14, was distended with ripe eggs. A female taken at Orient bay on June 12, and one taken on Shakespeare island on July 8, were full of eggs.

By July 13, most of the green frogs had dispersed from the Pustagone

ponds and there was a new generation of very young tadpoles just recently hatched, which were possibly of this species.

To judge from the state of development of full grown tadpoles taken at various dates throughout the summer, transformation begins early in July and continues into August.

***Rana pipiens* SCHREBER. LEOPARD FROG.**—This species, which is typically a lover of the open, cat-tail marshes, was seen less frequently than the green frog, but was not uncommon. It was taken on the main land at Ombabika bay, Onaman river, Muskeg lake, Cedar creek, Macdiarmid and at the Pustagone river. The island records are from Shakespeare and Naonan islands.

These frogs were found always in low lying, open country, never very far from water.

The colouration of the specimens seen was normal. The largest measured 86 mm.

Neither the eggs nor tadpoles were found, and the only hint at breeding activities was at the Toad pond on June 14, when two male leopard frogs were found embracing female green frogs. Most of the females taken were small, and dissection of the few large ones does not throw enough light on the subject to be at all conclusive. The ovaries of a large female taken on June 14, contained only minute, white eggs. Another specimen taken on July 2 showed a similar condition. A specimen taken on July 24, was full of ripe eggs. Two newly transformed individuals were taken at Macdiarmid on Aug. 12, 1921.

***Rana septentrionalis* BAIRD. MINK FROG.**—This interesting frog was not plentiful, and was the least common *Rana* in the district. Specimens were taken at Centre lake, Muskeg lake, First Station lake, Macdiarmid and Pustagone ponds.

It is a decidedly aquatic frog and was never seen at a greater distance from water than could be covered by a single leap. Its preference seemed to be for rivers and small lakes. In the latter it was found more especially about outlets or inlets where there is a gentle current. It was also found in quiet, bog-margined lakes without current. It was taken about water holes in the sphagnum-covered floor of wet, coniferous woods, and in the shallow pools beside the C.N.R. track at Macdiarmid.

The specimens collected ranged from 42 to 57 mm. in length. The length of the hind leg to the ankle averaged 83.39 per cent. of the total length. In colouration the Nipigon specimens were quite similar to those seen in other parts of Ontario.

A croaking male was taken in First Station lake on July 5, 1924. A female taken in a water hole in the woods on June 4, 1922, contained

ripening eggs. One taken at the C.N.R. pools, Macdiarmid, on June 11, 1921, was distended with ripe eggs. Another female taken at Centre lake on July 21, 1924, was without eggs.

REPTILES

***Thamnophis s. sirtalis* (LINN.). COMMON GARTER SNAKE.**

—This snake, the only species found, was not plentiful, only thirteen specimens having been secured. A few others were seen but escaped. It was taken at Macdiarmid, Cedar creek and Sandy river.

The specimens collected were quite typical. The dorsal scales were 19-17 in every case; the ventral plates ranged from 149 to 167; the supra labials were 7, except in one specimen which had 8 on the left side; the infra labials were 10 in nine specimens, 9 in three, and 8 in one; the oculars in every case were 1-3.

The specimens ranged in length from 202 to 968 mm. In four, the tip of the tail was broken off. For the other nine the tail averaged 21.76 per cent. of the total length. The maximum was 25.55 and the minimum 20.52 per cent.

The colour and markings of these snakes was for the most part normal. The dorsal and lateral stripes were dull greenish yellow, as was also the belly. The lateral stripes were in most cases not well defined below, owing to the faintness of the dusky band on the first row of scales and edges of the ventral plates.

One specimen showed a melanistic tendency. The light lateral stripe was almost completely invaded by black, which also came well down on the margins of the ventral plates. The dorsal stripe was dusky and faded out completely at the base of the tail.

Another specimen showed much red in life, the lateral stripes being strongly reddish, especially on the anterior fifth of the body, the red extending onto the sides of the head. The ventral plates were finely mottled with red which was continuous across the first few plates behind the neck, and the last twenty-five or more in front of the vent.

***Chrysemys marginata bellii* (GRAY). BELL'S TURTLE.**—Only three specimens of this turtle were found; two at Blackwater river in June, 1921, by an Indian, and one at the south end of Orient bay on June 12, 1924, by L. L. Snyder.

The Orient bay specimen was a young one, the measurements taken with calipers were as follows: length of carapace 104 mm., greatest width, 86 mm., greatest depth of body, 27 mm. The carapace was olive green and the plastron reddish, and all the markings were clear and brilliant. The Blackwater river specimens were large, their measur-

ments were respectively: length of carapace, 176 and 200 mm., greatest width, 132 and 144 mm., greatest depth of body, 57 and 68 mm. They were dark umber brown above and yellowish, suffused with red below, the markings for the most part rather dull and subdued. In all of these specimens the costal scutes were each crossed at the middle by a transverse, crescent-shaped, light bar. The dark patch on the plastron was also characteristic, sending out extensions along the sutures almost to the margin of the shell. In the young specimen all the spots on the limbs and the stripes on the head and neck were lemon yellow.

LITERATURE CITED

- Dymond, J. R. 1926. The fishes of Lake Nipigon. Univ. of Toronto Studies: Biol. Series, Pub. Ontario Fisheries Research Lab., No. 27.
- Gage, S. H. 1891. Life-history of the vermilion-spotted newt, *Dicmyctylus viridescens*. Amer. Nat., **35**: 1084-1110.
- Pope, Philip H. 1924. The Life-history of the common water-newt (*Notophthalmus viridescens*) together with observations on the sense of smell. Annals Carnegie Museum, **15**: 305-368.
- Wilson, Alfred W. G. 1910. Geology of the Nipigon basin, Ontario. Memoir No. 1, Dept. Mines, Geol. Survey Br., Canada.

A BIBLIOGRAPHY OF CANADIAN PLANT GEOGRAPHY TO THE END OF THE YEAR 1920

Compiled by J. ADAMS,
Ottawa, Ont.

In addition to the Dominion of Canada the present Bibliography deals with the adjacent territories of Alaska and Labrador, the islands of Newfoundland, St. Pierre, and Miquelon, and the Arctic Islands to the north of Canada; it does not, however, include Greenland.

It does not profess to be a complete account of all the literature bearing on the distribution of Canadian plants, neither is perfect accuracy claimed for each citation. To prepare a satisfactory bibliography on any subject so as to ensure the correctness of author's name, title of article quoted, volume, pages included, and date of publication, it would be necessary to have access to and handle each of the works referred to. In the present instance this has been possible in comparatively few cases. Access to the actual publication is absolutely necessary in many cases in order to determine whether it really contains any material bearing on the subject with which the Bibliography deals, since this is not always obvious from the title. In many cases quoted in the present Bibliography the words "Canadian references" will be found added in brackets to show the justification for their inclusion. It might be inferred that some of the earlier works dealing with the distribution of plants in North America would also mention Canadian localities but this is not necessarily the case. Such inclusions must be regarded as doubtful until they have been consulted and the question verified.

The first attempt to bring together the literature dealing with the distribution of Canadian plants appears to be that of Prof. D. P. Penhallow of Montreal whose "Review of Canadian Botany from the first Settlement of New France to the Nineteenth Century" was published in 1888 in the Transactions of the Royal Society of Canada. The second part bearing the title "A Review of Canadian Botany from 1800 to 1895" was published in the Transactions of the same society in 1897.

Shortly after the publication of the first part of Prof. Penhallow's Review there appeared in the Annals of the New York Academy of Science for 1890, "A List of State and Local Floras of the United States and British America", by Dr. N. L. Britton of the New York Botanical Garden. In this list, as might be inferred from the title, the literature dealing with each province of Canada was indicated separately. Alto-

gether 138 titles are enumerated for Canada. From the year 1900 up to 1915 Dr. A. H. Mackay of Halifax has compiled an annual "Botanical Bibliography of Canada" which has been published in the "Transactions of the Royal Society of Canada" among the papers dealing with the Biological Sciences.

Finally the "Bulletin of the Torrey Botanical Club" has published regularly (almost from its first appearance in 1870) a monthly bibliography entitled "Index to American Botanical Literature".

The various items comprised in a bibliography might be grouped in one of three ways, namely, according to (1) the date of publication, (2) the names of the authors mentioned, and (3) the subdivisions of the subject. The arrangement adopted below is a combination of the first two, consisting of six chronological periods in each of which the authors' names are arranged in alphabetical order. Where there are several titles by the same author these are grouped in the order of publication. Where the publication of a work covers a period of several years it will be found listed under the date of the first number issued.

As each item on the list has a number prefixed it will be comparatively easy to compile a list of papers and books dealing with a particular subdivision of the Vegetable Kingdom or the Flora of an individual province by cataloguing the numbers which have reference to that subdivision or province concerned.

A note of interrogation after the year of publication signifies that the date is probably correct but needs verification by comparison with the original.

SECTION I. PUBLICATIONS BEFORE THE END OF THE YEAR 1800

1. BARTON, B. S.—A geographical view of the trees and shrubs of North America. Trans. Americ. Philos. Soc., 1800.
2. BOUCHER, P.—Histoire Naturelle de la Nouvelle France vulgairement dite le Canada. Paris, 1665.
3. CATESBY, MARK—Hortus Britanno-Americanus; or a curious collection of trees and shrubs the produce of the British Colonies in North America, adapted to the soil and climate of England; with observations on their constitution, growth, and culture. London, 1763.
4. CHARLEVOIX—"Description des Plantes Principales de l'Amérique Septentrionale" in "Histoire et Description Generale de la Nouvelle France", tome 4, pp. 299-377. Paris, 1744.
5. CORNUT, J. P.—Canadensium Plantarum Aliarum que Nondum Editarum historia. 238 pp. Paris, 1635; Paris, 1662.

6. DENIS, N.—Description Geographique et Historique des Côtes de l'Amérique Septentrionale, avec l'Histoire Naturelle de ce Pays. Paris, 1672.
7. DOBBS, A.—An Account of the Countries adjoining Hudson's Bay. London, 1744.
8. DUHAMEL DU MONCEAU, H. L.—Observations Botanico-Meteorologique faites à Quebec en Canada 1744-45. Dans les Memoires de l'Academie. Paris, 1746.
9. FORSTER, J. R.—Flora Americae Septentrionalis; or a Catalogue of North American Plants. 51 pp. London, 1771.
10. HEARNE, S.—A Journey from Prince of Wales Fort in Hudson's Bay to the Northern Ocean 1769-1772. London, 1796.
11. HENNEPIN, L.—A new discovery of a vast country in America, extending about 4000 miles, between New France and Mexico; with descriptions of the great lakes, cataracts, rivers, plants, and animals, etc. London, 1698.
12. KALM, P.—En Resa til Norra America. Stockholm, 1753-1761.
13. KALM, P.—Beschreibung der Reise nach dem Nördlichen Amerika. Göttingen, 1754.
14. KALM, P.—Norra Americanska fargaorter. Abo, 1763.
15. KALM, P.—Travels in North America. London, 1770.
16. LAFITAU, J. F.—La Plante du Ginseng de Tartarie découverte en Canada. Paris, 1718.
17. PICHON, T.—Lettres et Memoires pour servir à l'histoire naturelle, civile et politique du Cape Breton, depuis son établissement jusqu'à la reprise de cette isle par les Anglais en 1758. London, 1760.
18. PLUMIER, P. CAROLUS.—Nova plantarum Americanarum genera. Paris, 1703.
19. ROBSON, J.—Account of Six Years' Residence in Hudson's Bay, from 1733 to 1736, and from 1744 to 1747. London, 1752.
20. SCHOEPF, DR. (of Erlangen)—Materia Medica Americana potissimum regni vegetabilis. 1787.
21. SCHOEPF, DR. (of Erlangen)—Specifica Canadensium Amoenitates Academicæ, vol. 4, Dissertatio LXXII (before 1798).
22. UMFREVILLE, E.—The present state of Hudson's Bay; containing a full description of that settlement and the adjacent country. London, 1790.
23. WELD, I.—Travels through the States of North America and of the Provinces of Upper and Lower Canada 1795-1797. London, 1800.

SECTION II. 1801-1850

24. AGASSIZ, J. L. R. & CABOT, J. E.—Lake Superior, its physical characters, vegetation and animals. 428 pp. 17 pl. Boston, 1850. (Vegetation of the northern shores, pp. 139-190).
25. BACHELOT DE LA PYLAIE, A. J. M.—Quelques observations sur les productions de l'île de Terre-Neuve, et sur quelques Algues de la côte de France appartenant au genre Laminaire. Ann. Sci. Nat., vol. 4, pp. 174, 184; pl. 9, 1824.
26. BACHELOT DE LA PYLAIE, A. J. M.—Voyage à l'île de Terre-Neuve 1825 (includes higher plants).
27. BACHELOT DE LA PYLAIE, A. J. M.—Flore de l'île de Terre-neuve et des îles Saint Pierre et Miclou. 128 pp. Paris, 1829. (Includes Algae).
28. BARNSTON, GEORGE—Observations on the Progress of the Seasons as affecting animals and vegetables at Martin's Falls, Albany River, Hudson's Bay. Edin. New Phil. Jour., vol. 30, p. 252, 1841?
29. BARTON, B. S.—Geographical View of the Trees of North America between latitudes 71 and 25, with plates. 36 pp. Philadelphia, 1809.
30. BARTON, W. P. C.—A Flora of North America. Philadelphia, vol. 1, 1821; vol. 2, 1822; vol. 3, 1823. Plates.
31. BARTRAM, W.—An Account of the Species, Hybrids, and other varieties of the Vine of North America. New York Med. Repos., vol. 1, pp. 19-24, 1804.
32. BAUER, F.—Some experiments on the Fungi which constitute the colouring matter of the Red Snow discovered in Baffin's Bay. Phil. Trans. Roy. Soc. London, part I, pp. 165-173, pl. 17, 1820; and Am. Jour. Sc. Arts, vol. 2, p. 356, 1820.
33. BACK, SIR GEORGE—Narrative of the Arctic Land Expedition to the mouth of the Great Fish River. App. II, p. 523. London, 1836.
34. BONGARD, M.—Observations sur la vegetation de l'île de Sitcha. Mem. Acad. Sc. St. Petersb., vol. 6, ser. 2, pp. 119-178, 1833. Review in Ann. Sc. Nat. Bot., vol. 3, ser. 3, pp. 236-8, 1835.
35. BROWN, ROBERT—List of Plants collected on the Coasts of Baffin's Bay and at Possession Bay. London, 1819.
36. BROWN, R.—Extracts from Dr. Richardson's Botanical Appendix to the Narrative of a Journey to the Shores of the Polar Seas by Capt. John Franklin. London, 1823.
37. BROWN, R.—Flora der Melville Insel. Flora, vol. 7, pp. 65-135, 1824.

38. BROWN, R.—*Chloris Melvilliana*. A List of Plants collected at Melville Island in the year 1820, by the Officers of the Voyage of Discovery under orders of Captain Parry. London, 1823-24. Appendix, Parry's 2nd Voyage, Supplement. London, 1824.
39. BROWN, R.—General View of the Botany of the vicinity of Swan River, 1830. Jour. Geol. Soc., vol. 1, pp. 17-20, 1832.
40. BROWNE, D. J.—*The Sylva Americana*. Boston, 1832.
41. BROWNE, D. J.—*The trees of America, native and foreign, etc.* New York, 1846.
42. COCHRAN, WILLIAM—List of Plants in "An Historical and Statistical Account of Nova Scotia", by T. C. Haliburton. Vol. 2, p. 405, 1829.
43. DAWSON, Sir J. W.—On the destruction and partial reproduction of forests in British North America. Am. Jour. Sc., vol. 2, ser. 4, pp. 161-170, 1847.
44. DAWSON, J. W.—*Reproduction of Forests Destroyed by Fire*. Edin. Phil. Jour., 1847.
45. DOUGLAS, DAVID—Sketch of a Journey to the Northwestern part of the continent of North America during the years 1824-27. Hooker's Comp. Bot. Mag., vol. 2, pp. 82-103, 1836.
46. DOUGLAS, D.—*Summer Excursions to the Columbia River*. Hooker's Comp. Bot. Mag., vol. 2, pp. 103-124, 1836.
47. DOUGLAS, D.—*A Journey to Hudson's Bay*. Hooker's Comp. Bot. Mag., vol. 2, 1836.
48. DOUGLAS, D.—*Observations taken on the West Coast of North America*. Proc. Roy. Soc., vol. 3, p. 471, 1837.
49. DOWNING, J. A.—*The fruits and fruit trees of America, etc.* New York, 1845 and 1847.
50. EATON, A.—*Manual of Botany of North America*. 1st ed. 1817; 2nd ed. 1818; 3rd ed. 1822; 4th ed. 1824; 5th ed. 1829; 6th ed. 1833; 7th ed. 1836.
51. EATON, A. & WRIGHT, J.—*North American Botany*. 8th ed. Troy, 1840.
52. GOLDIE, JOHN—Description of some new and rare plants discovered in Canada in the year 1819. Edin. Phil. Jour., vol. 6, p. 319, 1822.
53. GOSSE, P. H.—*The Canadian Naturalist, Fauna and Flora*, 372 pp. London, 1840.
54. GOTTSCHKE, C. M., LINDENBERG, J. B. G. & NEES VON ESENBECK, C. G.—*Synopsis Hepaticarum*. Hamburg, 1844-47. (Some Alaskan Species).
55. GRAY, ASA—*Melanthacearum Americae Septentrionalis Revisio*.

- Ann. Lycaeii Historiae Naturalis. Novi-Eboraci, vol. 4, pp. 105-140, 1837. (Contains Canadian references.)
56. GRAY, A.—Genera Florae Americae. New York, 1848-49.
 57. HOOKER, SIR WILLIAM JACKSON—Some account of a collection of Arctic plants found by Edward Sabine during a voyage in the Polar Seas in the year 1823. London, 1824.
 58. HOOKER, W. J.—Flora boreali-americana; or the Botany of the Northern parts of British America. Vol. 1, pp. 351, 4°, London, 1833; vol. 2, pp. 328, 4°, London, 1840. (236 plates.)
 59. HOOKER, W. J.—List of plants collected by Mr. Richard King during the progress of Captain Back's Arctic land expedition. Narrative Back's Expedition, pp. 523-531, 1835.
 60. HOOKER, W. J. & ARNOTT, G. A. W.—The botany of Captain Beechey's voyage; comprising an account of the plants collected—during the voyage to the Pacific and Behring's Strait—in the years 1825, '26, '27 and '28. Pp. 1-485, 99 pls. London, 1841.
 61. KLOTZSCH, J. F. & BERKELEY, M. J.—Fungi exotici e collectionibus Britannorum. Linnaea, vol. 8, pp. 478-490, pl. 11, 12, 1833. (Includes N. Amer. sp. mostly collected by Sir J. Richardson.)
 62. LEDEBOUR, C. F.—Flora Rossica sive enumeratio plantarum in totius imperii Rossici Provinciis Europaeis, Asiaticis, et Americanis hucusque observatarum. Stuttgartiae. vols. 1-4, 1841-1853.
 63. LYON, CAPTAIN—A brief narrative of an unsuccessful attempt to reach Repulse Bay through Sir Thomas Rowe's "Welcome" in H.M.S. "Griper" in 1824. 8vo, 1825. (Appendix of Botany by Hooker.)
 64. MACLAGAN, P. W.—Notice of plants collected in the line of the Rideau Canal, Canada West. Trans. Bot. Soc. Edin., vol. 3, pp. 11-14, 1850.
 65. MEEHAN, T.—Catalogue of Canadian Plants collected in 1827 and presented to the Literary and Historical Society by the R.H. the Countess of Dalhousie. Trans. Lit. and Hist. Soc. Quebec, vol. 1, pp. 255-261, 1829.
 66. MEYER, E. H. F.—De plantis Labradoracis. Lipsiae, 218 pp., 1830.
 67. MICHAUX, FRANCOIS ANDRÉ.—Histoire des chênes de l'Amérique. 30 pp., 36 pl. Paris, 1801.
 68. MICHAUX, F. A.—Geschichte der amerikanischen Eichen. Stuttgart, 1802.
 69. MICHAUX, F. A.—Flora Boreali-Americana. Paris, 2 vols., 1803. Ed. 2, 1828. (Includes Canada and Newfoundland.)
 70. MICHAUX, F. A.—Memoire sur la naturalisation des arbres

forestiers de l'Amérique septentrionale, dans lequel on indique ce que l'ancien gouvernement avait fait pour arriver à ce but, et les moyens qu'il conviendrait d'employer pour y parvenir; suivi d'un tableau raisonné des arbres de ce pays, comparés avec ceux que produit le France. Paris, 1805.

71. MICHAUX, F. A.—Histoire des Arbres forestiers de l'Amérique septentrionale. Paris, 3 vols., 1810-13.
72. MICHAUX, F. A.—The North American sylvia or a description of the forest trees of the United States, Canada, and Nova Scotia considered particularly with respect to their use. Trans. from French by A. L. Hillhouse. 3 vols., illus. Paris and Phila., 1818-19; 2nd ed., 3 vols., illus. New Harmony Ind., 1840; 3 vols., illus. Philadelphia, 1841-2; 3 vols., illus. Philadelphia, 1853; 3 vols., illus. Philadelphia, 1859; 3 vols., illus. Philadelphia, 1865; vol. I, ed. by J. J. Smith, 1853.
73. MONTAGNE (JEAN FRANCOIS) CAMILLE—Sixième centurie de plantes cellulaires exotiques nouvelles. Decades 8-10. Ann. Sc. Nat. Bot. ser. 3, vol. 12, pp. 285-320, 1849. (Includes Newfoundland fungi).
74. MONTAGNE, J. F. C.—Sixième centurie de plantes cellulaires nouvelles, tant indigenes qu'exotiques. Decades III a VI. Ann. Sc. Nat., ser. 3, vol. 11, pp. 33-66, 1849. (Algae from Labrador, etc.).
75. MONTAGNE, J. F. C.—Huitième centurie de plantes cellulaires, etc. Decades 9-10. Ann. Sc. Nat. Bot., ser. 3, vol. 12, pp. 167-192, 1849. (Includes Newfoundland fungi).
76. MORRIS, MARIA—Wild Flowers of Nova Scotia, pts. I-IV, with 12 coloured plates, accompanied with information on the history, properties, etc., of the subjects by Titus Smith and Rev. A. Forrester, 4°. Halifax, N.S., 1840-53.
77. MUHLENBERG, H.—Catalogus plantarum Americae septentrionalis, 112 p. Lancaster, 1813, 2 ed., 122 pp. Lancaster, 1813.
78. MUHLENBERG, H.—Descriptio uberior graminum et plantarum Calamariarum Americae Septentrionalis. 295 pp. Phila., 1817.
79. MUHLENBERG, H.—Catalogue of the Plants of North America, 1818.
80. NICHOLSON, T.—On the Red Snow of the Arctic Regions. Mag. Nat. Hist., vol. 2, pp. 321-3, 1829.
81. NUTTALL, T.—The genera of North American plants and a catalogue of the species to the year 1817. 2 vols. Phila., 1818.

82. NUTTALL, T.—Catalogue of a collection of plants made chiefly in the valleys of the Rocky Mts. or Northern Andes towards the sources of the Columbia river by Nathaniel B. Wyeth. *Jour. Phila. Acad. Nat. Sc.*, vol. 7, pp. 5-60, 1834.
83. NUTTALL, T.—North American sylvia; or a description of the forest trees of the United States, Canada and Nova Scotia, not described in the work of F. A. Michaux. 3 vols., illus. Phila., 1842-54; 3 vols., illus. Phila., 1852; 3 vols., illus. Phila., 1865.
84. PURSH, F. T.—*Journal of Botanical Excursions*, 1807.
85. PURSH, F. T.—*Flora Americae Septentrionalis*. 2 vols., illus. London, 1814. Reprint, 2 vols., illus. London, 1816.
86. RAFINESQUE, C. S.—*New Flora and Botany of North America*. Parts 1-4. Phila., 1836.
87. RAFINESQUE, C. S.—*Sylva telluriana mantissa synoptica: trees and shrubs of North America*. Phila., 1838.
88. RICHARDSON, Sir J.—Botanical appendix to narrative of a journey to the shores of the polar sea in the years 1819, 1820, 1821 and 1822 by John Franklin. *Narrative*, pp. 729-768, pls. 27-30. Lond., 1823. Reprint, p. 55.
89. RICHARDSON, J.—Remarks on the climate and vegetable productions of the Hudson's Bay countries. *Edin. Phil. Jour.*, vol. 12, pp. 197-231, Apr. 1825. Reprint, pp. 35.
90. SCHWEINITZ, L. D. VON—Catalogue of plants collected in the north western territory by Thomas Say in the year 1823. Keating's narrative of Long's 2nd expedition to source of St. Peter's River. Vol. 2, pp. 379-400. London, 1824, also in 2nd ed., pp. 105-123, 1825.
91. SCHWEINITZ, L. D. VON—Monograph of the North American species of the genus *Carex*. Ed. by John Torrey. New York, 1825.
92. SCHRANK, F. VON P. VON—Aufzählung einiger Pflanzen aus Labrador. *Denkschrift Regensb. Bot. Gesell.* 1, Abth. 2, 1-30, 1818.
93. SELLER, W.—Observations on some plants obtained from the shores of Davis Straits. *Trans. Bot. Soc. Edin.*, vol. 2, pp. 215-223, 1846.
94. SMITH, TITUS—A list of the principal indigenous plants of Nova Scotia. *M. Mag.*, vol. 1, p. 342. Halifax, N.S., Feb., 1831.
95. SMITH, T.—On the operation of Fungi in disintegrating vegetable substances. Vol. 1, p. 339, *M. Mag.* Halifax, N.S., Feb., 1831.
96. SMITH, T.—The Vegetation of Nova Scotia. *Mag. Nat. Hist.*, 1835.

97. SPRINGER, J. S.—Forest life and forest trees in Maine and New Brunswick. New York, 1837.
98. STRONG, A. B.—The American flora. Vols. 1-4. New York, 1848.
99. SULLIVANT, WILLIAM S.—Contributions to the Bryology and Hepaticology of North America. Mem. Acad. Arts and Sc. n. ser., vol. 3, p. 57, 1847.
100. TITFORD, W. I. (M.D.)—Sketches towards a Hortus botanicus Americanus, etc. London, 1812.
101. TORREY, JOHN (M.D.)—Notice of plants collected by Prof. D. B. Douglas during the summer of 1820, around the Great Lakes and the upper waters of the Mississippi. Amer. Jour. Sc., vol. 4, p. 56, 1822.
102. TORREY, J.—Flora of the Northern and Middle Sections of the United States. New York, 1824.
103. TORREY, J.—A compendium of the Flora of the northern and middle states. New York, 1826.
104. TORREY, J.—Catalogue of North American Genera of Plants. New York, 1831.
105. TORREY, J.—Monograph of North American Cyperaceae. New York, 1836.
106. TORREY, J.—Flora of the State of New York. New York, 1843.
107. TORREY, J. & GRAY, A.—Flora of North America . . . north of Mexico. 2 vols. New York, 1838-43.
108. TUCKERMAN, EDWARD—Enumeration of North American Lichens. Cambridge, Mass., 1845.
109. TUCKERMAN, E.—A synopsis of the Lichenes of New England, the other Northern States, and British America. Cambridge, 1848. (Can. ref.).
110. TUCKERMAN, E.—Synopsis of Lichens of Northern New England and British America. Proc. Amer. Acad. Sc., vol. 1, pp. 195, 285, 1848.
111. TUCKERMAN, E.—Lichenes Americae Septentrionalis Exsiccati. Vol. 1, 2, Cambridge, Mass., 1847; vols. 3, 4, Boston, 1854; vols. 5, 6, Boston, 1855.

SECTION III. 1851-1875

112. ADAMS, A. L.—Field and Forest Rambles . . . Eastern Canada. London, 1873.
113. ALEXANDER, SIR JAMES E.—L'Acadie; or Seven years explorations in British America. Prob. between 1851-1875. (Contains account of plants of N.B.).

114. ALLEN, J. A.—List of plants collected in the North Pacific R.R. Expeditions of 1873 under General D. S. Stanley. Proc. Bost. Soc. Nat. Hist., vol. 17, pp. 70-86, 1874.
115. ANDERSON, N. J.—*Salices boreali americanæ*, pp. 32. Cambridge, 1858; Proc. Amer. Acad., vol. 4, p. 50.
116. BAILEY, LORING WOART—Notes on Diatomaceæ from the St. John River. Can. Nat. and Geol., vol. 8, pp. 92-5, 1863.
117. BAILEY, L. W.—Notes on the Geology and Botany of New Brunswick. Can. Nat., n. ser., vol. 1, p. 81, 1864 (?).
118. BAILEY, L. W.—Desmids and Diatoms. Amer. Nat., vol. 1, pp. 505-587, 1867 (?).
119. BALFOUR, J. H.—Remarks on species of *Elymus*, *Triticum*, and *Phleum* from Vancouver's Island. Trans. Bot. Soc. Edin., vol. 9, pp. 301-303, 1868.
120. BARNSTON, GEORGE—Remarks upon the geographical distribution of the order Ranunculaceæ throughout the British possessions of North America. Can. Nat., vol. 2, p. 12, 1858 (?).
121. BARNSTON, G.—Remarks on the geographical distribution of the Cruciferae throughout the British possessions of North America. Can. Nat., vol. 4, p. 1, 1860 (?).
122. BARNSTON, G.—Geographical distribution of the genus *Allium* in British North America. Can. Nat., vol. 4, p. 116, 1860 (?).
123. BARNSTON, G.—Sketch of the Life of David Douglas. Can. Nat., vol. 5, pp. 120, 200, 267, 329, 1861 (?).
124. BARNSTON, JAMES—General remarks on the study of nature with special reference to Botany. Can. Nat., vol. 2, p. 34, 1858(?).
125. BARNSTON, J.—Hints to young botanists regarding the collection, naming and preserving of plants. Can. Nat., vol. 2, p. 127, 1858 (?).
126. BARNSTON, J.—Introductory lecture to the course on Botany, delivered before the students of Arts and Medicine, McGill University, Session, 1857. Can. Nat., vol. 2, p. 335, 1858(?).
127. BARNSTON, J.—Catalogue of the Canadian plants in the Holmes' Herbarium, in the cabinet of the University of McGill College. Can. Nat., vol. 4, pp. 100-116, 1859. Reprinted, 20 pp. Montreal, 1859.
128. BELL, J.—The plants of the west coast of Newfoundland. Can. Nat., vol. 4, ser. 2, pp. 256-263, 1869; vol. 5, pp. 54-61, 1870.
129. BELL, J.—List of plants collected in the Manitoulin Islands. Rep. Progr. Geol. Surv. Canada, 1866-9, pp. 449-465, 1870. French ed., same vol., pp. 501-524, 1871.
130. BELL, ROBERT—The Natural History of the lower St. Lawrence, the Saguenay and Lake St. John. Geol. Surv. of Canada, 1857.

131. BELL, R.—Catalogue with notes, of animals and plants collected on the southeast side of the St. Lawrence from Quebec to Gaspé. Geol. Surv. of Canada, 1858.
132. BELL, R.—Catalogue of plants collected in the eastern peninsula of lower Canada, from Quebec to Gaspé, in Geol. Surv. Montreal, 1859.
133. BELL, R.—On the natural history of the gulf of St. Lawrence. Can. Nat., vol. 4, p. 241, 1860 (?).
134. BERKELEY, MILES JOSEPH—An account of the plants collected by Dr. Walker in Greenland and Arctic America during the expedition of Sir Francis McClintock, R.N., in the yacht "Fox" by J. D. Hooker, M.D. Jour. Linn. Soc., vol. 5, pp. 79-89, 1861; Manual Arctic Expedition, Part 2, p. 526.
135. BERKELEY, M. J.—Notices of North American Fungi. Grevillea, vol. 1, 1872-3 and vol. 4, 1875-6.
136. BILLINGS, B.—List of plants collected on the south and east shores of Lake Superior and on the north shore of Lake Huron in 1860 by Robert Bell. Ann. Bot. Soc. Canada. Kingston, vol. 1, pp. 67-80, 1861.
137. BILLINGS, B.—List of plants collected on the island of Anticosti and coast of Labrador in 1860 by James Richardson. Ann. Bot. Soc. Can., vol. 1, pp. 58-59, 1861.
138. BILLINGS, B.—List of plants observed growing principally within four miles of Prescott, C.W., and for the most part in 1860. Ann. Bot. Soc. Can., vol. 1, pp. 114-140, 1861.
139. BILLINGS, B.—List of plants collected by Mr. B. Billings in the vicinity of the city of Ottawa, during the summer of 1866. Trans. Ottawa Nat. Hist. Soc. pp. 1-16, n.d. 1867 (?). (Includes some species collected in 1867).
140. BILLINGS, W. E.—List of plants found growing as indigenous in the neighbourhood of Prescott, C.W. Can. Nat. and Geol., vol. 3, pp. 39-50; vol. 5, pp. 14-24, 1860.
141. BONORDEN, H. F.—Die zweite deutsche Nordpolarfahrt in den Jahren 1869 und 1870 unter Führung des Kapitan Karl Koldewey, herausgegeben von dem Verein für die deutsche Nordpolarfahrt in Bremen, 8°. Leipzig, 1874; Arctic Manual, part 2, p. 585.
142. BOOT, FRANCIS—Table of distribution of Carices in Journal of a boat voyage through Rupert's Land by Sir John Richardson, C.B., F.R.S. London, vol. 2, p. 344, 1851.
143. BOURGEOU, —.—Botany of North America. Jour. Proc. Linn. Soc. Bot., vol. 4, pp. 1-16, 1860.

144. BRAITHWAITE, R.—On the organization of mosses. *Can. Nat.*, n. ser., vol. 3, p. 462, 1869 (?).
145. BROWN, R.—Letter from Robert Brown, Esq., Botanist to the British Columbia Association. *Trans. Bot. Soc. Edin.*, vol. 8, pp. 69-71, 1866. (Floral notes).
146. BROWN, R.—On the nature of the discoloration of the Arctic Seas. *Trans. Bot. Soc. Edin.*, vol. 9, pp. 244-252, 1868; *Quart. Jour. Mic. Soc.*, vol. 8, 240-7, 1868; *Am. Nat.*, vol. 2, pp. 383-4, 1868; *Petermann Mitth.*, vol. 15, pp. 21-23, 1869. (Mentions diatoms in Davis Strait).
147. BROWN, R.—A monograph of the coniferous genus *Thuja*, Linn., and of the North American species of the genus *Libocedrus*, Endl. *Trans. Bot. Soc. Edin.*, vol. 9, pp. 358-378, 1868.
148. BROWN, R.—On the vegetable products used by the North-west American Indians as food and medicine, in the arts, and in superstitious rites. *Trans. Bot. Soc. Edin.*, vol. 9, pp. 378-396, 1868.
149. BROWN, R.—On the geographical distribution of the Coniferae and Gnetaceae. *Trans. Bot. Soc. Edin.*, vol. 10, pp. 175-196, 1870.
150. BROWN, R.—Note on *Lilium canadense* L. var. *puberulum* Torr. *Trans. Bot. Soc. Edin.*, vol. 11, pp. 147-8, 1873. (Can. ref.).
151. BROWNE, D. J.—Trees of America, native and foreign. New York, 1846. New York, 1857.
152. BRUNET, L'ABBÉ LOUIS OVIDE—Notes sur les plantes recueillies en 1858 par M. l'Abbé Ferland sur les côtes de Labrador baignées par les eaux du Saint Laurent. 8 pp., n.d. Quebec, 1859 (?).
153. BRUNET, L. O.—Enumeration des genres de plantes de la Flore du Canada. Quebec, 1864.
154. BRUNET, L. O.—Voyage d'Andre Michaux au Canada. Quebec, 1864. *Can. Nat.*, vol 1, n. ser., p. 325, 1864.
155. BRUNET, L. O.—Catalogue des plantes Canadiennes, contenus dans l'herbier de l'Université Laval. Quebec, 1865.
156. BRUNET, L. O.—Catalogue des vegetaux ligneux du Canada pour servir a l'intelligence des collections de bois economiques envoyées à l'Exposition Universelle de Paris, 1867. Pp. 64. Quebec, 1867.
157. BRUNET, L. O.—Histoire des *Picea* qui se rencontre dans les limites du Canada. *Can. Nat.* n. ser., vol. 3, p. 102, 1868 (?).
158. BUCHAN, J. M.—Notes on the flora of Hamilton, Ontario. *Can. Jour.* (II), vol. 14, pp. 281-304, 1870.

159. BUTLER, S. R.—Labrador Plants. *Can. Nat.* (II), vol. 5, pp. 350-353, 1870.
160. CHAMPLAIN, S. DE—Oeuvres de Champlain. Quebec, 1870.
161. CLEVE, P. T.—On Diatoms from the Arctic Sea. *Bihang. Kongl. Svenska Vet. Akad. Handl.*, vol. 1, No. 13, 4 pl., 1872-3.
162. COOPER, J. G.—Forests and trees of North America as connected with climate and agriculture. *Agric. Report*, pp. 416-445, 1860.
163. CORMACK, WM. E.—Narrative of a journey across the island of Newfoundland 1822 (?). Reprint, St. John's, 1873.
164. CURTISS, A. H.—Catalogue of the phanerogamous and vascular cryptogamous plants of Canada and the northwestern portions of the United States. *Liberty*, pp. 8, 1873.
165. DALL, W. H.—Useful indigenous Alaskan plants. *Rep. Dept. Agric.*, pp. 187-9, 1868.
166. DALL, W. H.—Arctic Marine Vegetation. *Nature*, vol. 12, p. 166, 1875.
167. DAWSON, SIR JOHN WILLIAM, K.C.M.G.—Modern submerged forests at Fort Lawrence, N.S. *Quart. Jour. Geol. Soc.*, vol. 11, p. 119, 1856 (?).
168. DAWSON, J. W.—Alpine and Arctic Plants. Montreal, 1862.
169. DAWSON, J. W.—Review of Hooker's Outlines of the Distribution of Arctic plants. *Can. Nat.*, vol. 7, p. 334, 1862 (?).
170. DAWSON, J. W.—On the removal and restoration of forests. *Can. Nat.*, vol. 3, n. ser., p. 405, 1869 (?).
171. DAWSON, G. M.—List of plants collected during the summers of 1873-4 in the vicinity of the forty-ninth parallel, Lake of the Woods to the Rocky Mts. *Rep. Geol. and Resources of the region in the vicinity of 49th parallel, N. Amer. Boundary Commission, App. F*, 1875.
172. DICKIE, G.—Notes on the Algae, Southerland's Journal of a voyage in Baffin's Bay and Barrow Straits in the years 1850-51, vol. 2. London, 1852.
173. DICKIE, G.—Notes on flowering plants and algae collected during the voyage of the "Isabel". In "A Summer search for Sir John Franklin," by Commander R. A. Inglefield, Appendix. London, 1853.
174. ———
175. DICKIE, G.—Algae. J. D. Hooker's "An Account of the plants collected by Dr. Walker in Greenland and Arctic America during the Expedition of Sir Francis McClintock, R.N., in the yacht "Fox", 21 June, 1860. *Jour. Linn. Soc. Bot.*, vol. 5, p. 86, 1861.

176. DICKIE, G.—Notes on a collection of Algae procured in Cumberland Sound by Mr. James Taylor and remarks on arctic species in general. Jour. Linn. Soc. Bot., vol. 9, pp. 235-243, 1867.
177. DICKIE, G.—Notes of Algae collected on the coast of northwest America, by Mr. R. Brown. Trans. Bot. Soc. Edin., vol. 9, pp. 465-467, 1868.
178. DICKIE, G.—Notes of Mosses and Hepaticae, collected by Robert Brown, Esq., on the northwest coast of America. Trans. Bot. Soc. Edin., vol. 9, pp. 355-358, 1868.
179. DICKIE, G.—Notes on Mosses, etc., collected by Mr. James Taylor on the shores of Davis Strait. Jour. Linn. Soc., vol. 10, pp. 461-467, 1869.
180. DICKIE, G.—Notes on some Algae found in the North Atlantic Ocean. Jour. Linn. Soc. Bot., vol. 2, pp. 456-459, 1871.
181. DRUMMOND, ANDREW THOMAS—On the economical uses of *Sticta pulmonaria*, Hoffm. Ann. Bot. Soc. Can., p. 81, 1861.
182. DRUMMOND, A. T.—Contributions to the local flora of Kingston. Ann. Bot. Soc. Can. vol. 1, pp. 33-40, 1861.
183. DRUMMOND, A. T.—Brief list of Kingston plants. Ann. Bot. Soc. Kingston, 1862.
184. DRUMMOND, A. T.—Observations on Canadian geographical botany. Can. Nat. (II), vol. 1, pp. 405-419, 1861.
185. DRUMMOND, A. T.—Catalogue of Canadian lichens. Can. Nat., vol. 2, n. ser., p. 392, 1867 (?).
186. DRUMMOND, A. T.—Distribution of plants in Canada in some of its relations to physical and post geological conditions. Can. Nat., vol. 3, n. ser., p. 161, 1868 (?).
187. DRUMMOND, A. T.—Some statistical features of the flora of Ontario and Quebec, and a comparison with those of the United States flora. Can. Nat. (II), vol. 2, pp. 429-437, 1868.
188. DRUMMOND, A. T.—Introduced and spreading plants of Ontario and Quebec. Can. Nat. (II), vol. 4, pp. 377-387, 1869. Reprint, 12 pp.
189. DRUMMOND, A. T.—Notes on Tadousac plants. Can. Nat., p. 261, Sept. 1869. (Includes Lichens).
190. DURAND, E., JAMES, THOS. P. & ASHMEAD, SAMUEL—Enumeration of the arctic plants collected by Dr. I. I. Hayes in his exploration of Smith's Sound between parallels 78 and 82 during the months of July, August, and the beginning of September, 1861. Proc. Acad. Nat. Sc. Phila., 1863, pp. 93-96, 1864.

191. D'URBAN, W. S. M.—Catalogue of plants collected by Mr. Robert Bell about the Gulf of St. Lawrence, 1859.
192. D'URBAN, W. S. M.—Catalogue of plants collected in the counties of Argenteuil and Ottawa in 1858. *Can. Nat. and Geol.*, vol. 4, pp. 120-137, 1861.
193. EATON, DANIEL CODY—On the genus *Woodsia*. *Can. Nat. n. s.*, vol. 2, pp. 89-92, 1865.
194. EATON, D. C.—Notes on some of the plants in the Herbaria of Linné and Michaux. *Can. Nat.*, vol. 24, n. ser., 1872 (?).
195. EDWARDS, WM.—Revised Catalogue of North American Ferns. South Natick, Mass., Aug. 1874.
196. EHRENBERG, C. G.—Ueber eine frische Probe der die Crimson Cliffs scharlachroth farbenden Substanz aus der Baffin's Bai und das begleitende kleinste Leben. *Monatsb. Berlin Akad.*, p. 741. Berlin, 1851.
197. EHRENBERG, C. G.—Ueber die Tiefgrund-Verhältnisse des Oceans am Eingange der Davis-Strasse und bei Island. *Monatsb. Berlin Akad.*, pp. 275- 315, 1861.
198. EHRENBERG, C. G.—Ueber die von Kaptän Koldewey auf der deutschen Nordpol-Expedition gehobenen Tiefgrundproben. *Monatsb. Berlin Akad.*, pp. 628-631, 1868.
199. ENGELMANN, G. —A revision of the North American species of *Juncus* with a description of new or imperfectly known species. *Trans. St. Louis Acad. Sc.*, vol. 2, p. 424, 1865.
200. FITZGIBBON, A.—Canadian Wild Flowers. Ten handcoloured lithographs with botanical descriptions by C. P. Traill. 4°. Montreal, 1868.
201. GORRIE, W.—Notice of a plant called by travellers in Canada the Polar plant. *Trans. Bot. Soc. Edin.*, vol. 7, pp. 273-4, 1863.
202. GORRIE, W.—Remarks on the Polar or Compass Plant. *Trans. Bot. Soc. Edin.*, vol. 7, p. 310, 1863.
203. HARRINGTON, B. J.—Notes on the botany of a portion of the counties of Hastings and Addison. *Can. Nat. (II)*, vol. 5, pp. 312-19, 1870.
204. HARVEY, W. H.—Notice of a collection of Algae made on the northwest coast of North America, chiefly at Vancouver's Island by David Lyall, in the years 1859-61. *Jour. Linn. Soc. Bot.*, vol. 6, pp. 157-177, 1862.
205. HARVEY, W. H.—*Nereis Boreali-Americana*: or contributions towards a history of the Marine Algae of the Atlantic and Pacific coasts of North America. *Smiths. Contr. Knowl.*, part I *Melanospermeae*, vol. 3, pp. 1-144, pl. 1-12, 1852;

part II Rhodospermeae, vol. 5, pp. 1-247, pl. 13-36, 1853;
part III Chlorospermeae, vol. 10, pp. 1-119, pl. 37-50, 1858.
Supplement, 1858.

206. HECTOR, J.—Reports of recent botanical expeditions, I. Letter from Dr. Hector, North America, to Dr. Balfour. Trans. Bot. Soc. Edin., vol. 6, pp. 80-82, 1860. (Deals with Western Can.).
207. HECTOR, J.—Physical features of the central part of British North America, with special reference to its botanical physiognomy. Trans. Bot. Soc. Edin., vol. 7, pp. 168-196, 1863.
208. HINCKS, REV. WILLIAM—Specimen of Flora of Canada with preliminary remarks. Can. Jour., vol. 6, pp. 165-266, 1861; vol. 7, p. 108.
209. HITCHCOCK, C. H.—Canadian plants naturalized on Mt. Washington. Geol. N.H., vol. 1, pp. 572-3, 1874.
210. HOOKER, SIR JOSEPH DALTON—Outlines of the distribution of Arctic Plants. Trans. Linn. Soc., vol. 22, 1860.
211. HOOKER, J. D.—Outlines of the distribution of Arctic Plants. Trans. Linn. Soc., vol. 23, pp. 251-348, 1862. Can. Nat. n.s., vol. 3, pp. 325-362, 1868.
212. HOOKER, J. D.—Arctic Manual, 1875. (See No. 218).
213. HOOKER, J. D.—Determination of plants collected by Sir George Nares during the expedition of 1875-76.
214. HOOKER, J. D.—Discovery of *Asplenium viride* in New Brunswick. Nat. Hist. Rev., p. 150, 1865.
215. HOOKER, J. D.—On some collections of Arctic plants chiefly made by Dr. Lyall, Dr. Anderson, Herr Miertsching and Dr. Rae, during the expedition in search of Sir John Franklin, under Sir John Richardson, Sir Edward Belcher and Sir Robert M'Clure. Jour. Linn. Soc., vol. 1, p. 114, 1857.
216. HOOKER, J. D.—An account of the plants collected by Dr. Walker in Greenland and Arctic America during the expedition of Sir Francis McClintock, R.N., in the yacht "Fox". Jour. Linn. Soc., vol. 5, pp. 79-88, 1861.
217. HUBBERT, PROF.—Catalogue of the flowering plants and ferns indigenous to or naturalized in Canada. pp. 64, Quebec, 1867: pp. 28, Montreal, 1867.
218. JONES, T. RUPERT—Manual of the natural history, geology and physics of Greenland and the neighbouring regions; prepared for the use of the Arctic expedition of 1875 under the direction of the Arctic Committee of the Royal Society, and edited by Prof. T. Rupert Jones, together with instructions

- suggested by the Arctic Committee of the Royal Society for the use of the expedition. 8°. London, pp. 1-86, 1-782, 1875.
219. JORDAN, D. S.—A key to the higher algae of the Atlantic coast between Newfoundland and Florida. *Am. Nat.*, vol. 8, pp. 398-403 and 479-493, 1874.
220. JORDAN, D. S.—*Fucus serratus* and *Fucus anceps*. *Am. Nat.*, vol. 9, pp. 309-310, 1875 (Nova Scotia ref.).
221. KANE, ELISHA KENT—Arctic explorations. The second Grinnell expedition in search of Sir John Franklin, 1853-55, 2 vols. 8°, Philadelphia, 1857. (Vol. 2 contains list of plants collected by E. Durand.)
222. KEMP, ALEX. F.—The fresh-water algae of Canada. *Can. Nat. & Geol.*, vol. 3, pp. 331-345, and 450-466, 1858.
223. KEMP, A. F.—A classified list of marine algae from the lower St. Lawrence with an introduction for amateur collectors. *Can. Nat. & Geol.*, vol. 5, pp. 30-42, 1860.
224. KEMP, A. F.—Address before the Natural History Society of Montreal. *Can. Nat. & Geol.*, vol. 8, pp. 68-71, 1863.
225. KEMP, A. F.—Notice of *Fucus serratus* found in Pictou Harbour. *Can. Nat. Quart. Jour. Sc.*, n.s., vol. 5, pp. 349-350, 1870.
226. KITTON, F.—List of Diatomaceae collected by Dr. David Lyall, R.N., of the northwest coast of Br. North America Boundary Commission, 1858-9. *Jour. Linn. Soc. (Bot.)*, vol. 9, pp. 416-17, 1867.
227. KOLDEWEY, CAPTAIN—The German Arctic expedition of 1869-70. London, 1874.
228. LAWSON, GEORGE—Remarks on the distribution of plants in the northern states, Canada, and the Hudson's Bay Company's Territories, etc. *Trans. Bot. Soc. Edin.*, vol. 6, p. 41, 1860.
229. LAWSON, G.—On the structure and development of *Botrydium granulatum*. *Trans. Bot. Soc. Edin.*, vol. 6, pp. 424-431, 1860. (Occurrence in Lake Ontario at Kingston).
230. LAWSON, G.—Botanical society of Canada abstract of recent discoveries in botany and the chemistry of plants. Seaweed as a manure. *Can. Nat. & Geol.*, vol. 6, pp. 70-73, 1861.
231. LAWSON, G.—Remarks on some fibrous plants of Canada with letters from Lord Lyons and Lord Monck in reference to the use of the silk cotton of *Asclepias* in spinning. *Trans. Bot. Soc. Edin.*, vol. 7, pp. 375-378, 1863.
232. LAWSON, G.—Some account of plants collected in the counties of Leeds and Grenville, Upper Canada, in July 1862. *Trans. Bot. Soc. Edin.*, vol. 7, pp. 468-479, 1863. (Includes cryptogams also).

233. LAWSON, G.—Note on *Lemania variegata* of Agardh. Trans. Bot. Soc. Edin., vol. 7, pp. 521-524, 1863. (Can. ref.).
234. LAWSON, G.—Synopsis of the Canadian species of *Equisetum*. Trans. Bot. Soc. Edin., vol. 7, pp. 558-564, 1863.
235. LAWSON, G.—Record of progress of botanical science. Can. Nat., n. ser., vol. 1, p. 1, 1864.
236. LAWSON, G.—Gulf-weed at Cape Sable. Can. Nat. & Geol., vol. 2, (1), p. 3, 1864.
237. LAWSON, G.—Synopsis of Canadian ferns and filicoid plants. Trans. Bot. Soc. Edin., vol. 8, pp. 20-50, 1866; Edin. New Phil. Jour., vol. 19, p. 102; Can. Nat., n. ser., vol. 1, p. 262, 1864.
238. LAWSON, G.—Synopsis of Canadian ferns and filicoid plants. Can. Nat. (II), vol. 2, pp. 390-404, 1865.
239. LAWSON, G.—Notice of the occurrence of *Woodsia alpina* (*hyperborea*) in Gaspé, Canada East. Trans. Bot. Soc. Edin., vol. 8, p. 108, 1866.
240. LAWSON, G.—Remarks on *Myrica cerifera* or candleberry myrtle. Trans. Bot. Soc. Edin., vol. 8, pp. 108-9, 1866. (Can. ref.).
241. LAWSON, G.—The occurrence of *Calluna vulgaris* on the American continent and islands. Trans. Bot. Soc. Edin., vol. 8, pp. 324-327, 1866.
242. LAWSON, G.—Monograph of Ranunculaceae of the Dominion of Canada and adjacent parts of British America. Proc. and Trans. N. S. Inst. Nat. Sc., vol. 2, pp. 17-51, 1870.
243. LAWSON, G.—On the Ranunculaceae of the Dominion of Canada and of adjacent parts of British America. Can. Nat., vol. 4, n. ser., p. 407, 1870 (?).
244. LAWSON, G.—On the botany of the Dominion of Canada and adjacent parts of British America. Trans. Bot. Soc. Edin. (Part I, Ranunculaceae), vol. 10, pp. 345-348, 1870.
245. LAWSON, G.—On the Laminariaceae of the Dominion of Canada and adjacent parts of British America. Proc. and Trans. N. S. Inst. Nat. Sc., vol. 2, pp. 109-111, 1870.
246. LAWSON, G.—Descriptions of the Canadian species of *Myosotis* or forget-me-not, with notes on other plants of the Natural Order Borraginaceae. Can. Nat., n. ser., vol. 4, p. 398, 1870 (?).
247. LAWSON, G.—North American Laminariaceae. Can. Nat. Quart. Jour. Sc., n.s., vol. 5, pp. 99-101, 1870.
248. LAWSON, G.—On the Ericaceae of Canada and adjacent parts of British America. Trans. Bot. Soc. Edin., vol. 2, pp. 163-168, 1873.

249. LEIDY, J.—Red Snow. Proc. Phila. Acad., vol. 6, p. 59, 1852. (Arctic).
250. LEIGHTON, W. A.—Notes on lichens collected by Sir John Richardson in Arctic America. Jour. Linn. Soc., vol. 9, pp. 184-200, 1867.
251. LINDSAY, WILLIAM LAUDER—What to observe on Canadian Lichens. Can. Nat., vol. 6, p. 282, 1862 (?).
252. LINDSAY, A. W. H.—Introduction to a synopsis of the flora of Nova Scotia by John Sommers, with a catalogue of the flora of Nova Scotia. Proc. and Trans. N. S. Inst. Nat. Sc., vol. 4, pp. 181-222, 1875.
253. LOGIE, ALEXANDER—List of plants found growing in the neighbourhood of Hamilton during the years 1859-60. Ann. Bot. Soc. Can., vol. 1, pp. 90-108, 1861.
254. LOGIE, A.—On the *Asclepias incarnata*, L., as a fibre-producing plant. Ann. Bot. Soc. Can., p. 87, 1861.
255. LOGIE, A.—On the flora of Hamilton and its vicinity. Can. Nat., vol. 6, p. 276, 1862 (?); Can. Jour., vol. 2, p. 222.
256. LYALL, DAVID—Account of the botanical collection made in northwest America by David Lyall, surgeon and Naturalist to the North American Boundary Commission. Jour. Linn. Soc., vol. 7, pp. 124-144, 1863. Reprint, 21 pp. (Can. ref.).
257. MCCORD, D. R.—Notes on the habitats and varieties of some Canadian ferns. Can. Nat., vol. 2 (1), pp. 354-362, 1864.
258. McNAB, J.—On the discoveries of Mr. John Jeffrey and Mr. Robert Brown, collectors to the botanical expeditions to British Columbia between the years 1850-1866, with remarks on the cultivation of certain species. Trans. Bot. Soc. Edin., vol. 2, pp. 322-338, 1873.
259. MACOUN, JOHN—List of plants of Northumberland Co., Ontario. Ann. Kingston Bot. Soc., 1863.
260. MACOUN, J.—A catalogue of the Carices collected at Belleville, Ontario. Can. Nat., n. ser., vol. 3, pp. 56-60, 1868 (?).
261. MACOUN, J.—List of the plants and botanical report of the Peace River district and the Northwest Territories. Rep. Progr. Can. Pac. R.R., pp. 56-98, 1874.
262. MACOUN, J.—Botanical Report, Lake Superior to the Pacific Ocean. Pacific Railway Report, 1874.
263. MACOUN, J.—The botany of the east coast of Lake Huron. Can. Jour., 1874-75.
264. MACOUN, J.—Report on British Columbia and the Peace River and catalogue of the plants of the region. Ann. Rep. Geol. Surv. Canada, pp. 110-232, 1875-6.

265. MACOUN, J. & GIBSON, J.—Rare plants of the province of Ontario. Proc. and Trans. Bot. Soc. Edin., vol. 12, pp. 300-374, 1874.
266. MATTHEW, G. F.—On the occurrence of arctic and western plants in continental Acadia. Can. Nat. (II), vol. 4, pp. 139-166, 1869.
267. MERRIFIELD, MARY P.—Arctic Marine Vegetation. Nature, vol. 12, pp. 55-58, 1875.
268. MITTEN, W.—Bryology of Lat. 49° North America. Jour. Proc. Linn. Soc. (Bot.), vol. 8, pp. 12-55, 1864.
269. ———
270. MOULINS, C. DES—Vites bor. Americanae. Cambridge, 1858. Bordeaux, 1862.
271. MOYEN, L'ABBÉ J.—Cours elementaire de botanique et flore de Canada. 334 pp., 46 pl. cart. Montreal, 1871 and 1886.
272. MUNRO, DAVID RANSOM—Forest and ornamental trees of New Brunswick. St. John, N.B., 1862.
273. NORDSTEDT, C. F. O.—Desmidiæ arctoe Oefvers. Kongl. Vet. Akad. Foerhandl., vol. 32, pp. 13-43, 1875; Hedwigia, vol. 15, pp. 12-15, 19-25, 1876.
274. O'MEARA, E.—Diatoms from a fresh-water deposit found in Vancouver's Island. Quart. Jour. Mic. Sc., n.s., vol. 15, p. 409, 1875.
275. OSLER, W.—Canadian Diatomaceae. Can. Nat. Quart. Jour. Sc., n.s., vol. 5, pp. 142-151, 1870.
276. PIPER, R. U.—Trees of America. Parts 1-4 illus. Boston, 1855-58.
277. PROVANCHER, L'ABBÉ LEON—Traité Elementaire de Botanique. Quebec, 1858, 1882.
278. PROVANCHER, L.—Flore Canadienne ou description de toutes les plantes de forêts, champs, jardins, et eaux du Canada, 8°, 1-29, pp. 1-842, Quebec, 1862.
279. REDFIELD, JOHN H.—Geographical distribution of ferns of North America. Bul. Tor. Bot. Club, vol. 6, No. 1, pp. 1-7, Jan. 1875.
280. REEKS, H.—A list of flowering plants and ferns of Newfoundland with meteorological observations. Pam. 8°, pp. 30, Newbury, 1873.
281. RICHARDSON, SIR JOHN—On the geographical distribution of plants in the country north of the 49° parallel of latitude. Richardson's Journal of a boat voyage, etc., vol. 2, pp. 264-353. London, 1851; New York ed., pp. 408-471, 1852.

282. RICHARDSON, J.—List of plants collected on the Island of Anticosti and Coast of Labrador in 1860. *Ann. Bot. Soc. Can.*, vol. 1, p. 58, 1861 (?).
283. ROBB, C. CHAS.—The principal Canadian timber trees. *Can. Jour.*, n. ser., vol. 6, 1861.
284. ROPER, F. C. S.—On *Triceratium arcticum*. *Trans. Mic. Soc.* n. ser., vol. 8, pp. 55-58, f. 1, 1860. (From Vancouver Id.).
285. ROSS, A. M.—Canadian ferns and wild flowers . . . of Ontario. Toronto, 1873.
286. ROSS, A. M.—The flora of Canada, pp. 29. Toronto, 1875.
287. ROSS, A. M.—Forest trees of Canada, pp. 6. Toronto, 1875.
288. ROSS, BERNARD R.—An account of the botanical and mineral products used by the Chippewayan Indians. *Can. Nat.*, vol. 7, p. 133, 1862 (?).
289. ROTHROCK, J. T.—Sketch of the flora of Alaska. *Rep. Smithsonian Institution for 1867*, pp. 433-463, 1867. Reprinted, 1868. (Includes also hepaticae, algae, lichens).
290. SADLER, J.—List of arctic cryptogamic plants, etc., collected by Robert Brown, Esq., during the summer of 1861, on the Islands of Greenland, in Baffin's Bay and Davis Straits. *Trans. Bot. Soc. Edin.*, vol. 7, pp. 374-5, 1863.
291. SADLER, S. C.—Recent additions to the flora of Canada. *Trans. Bot. Soc. Edin.*, vol. 10, pp. 383-4, 1870.
292. SCHULTZ, SIR JOHN C.—On the botany of the Red River Settlement and the old Red River Trail. *Ann. Bot. Soc. Can.*, vol. 1, pp. 25-33, 1861.
293. SEEMAN, BERTHOLD CARL—The botany of the voyage of H.M.S. *Herald* under the command of Capt. Henry Kellett, R.N. C.B., during the years 1845-51. 4°, pp. 483, pl. 100. London, 1852-7. (Includes Western Esquimaux Land).
294. SPOTTON, H. B.—List of plants collected in the vicinity of the town of Barrie, Ontario. *Can. Jour. (II)*, vol. 15, pp. 46-50, 1872.
295. SPRAGUE, C. J.—List of cryptogamous plants collected at Lake Superior by Dr. S. Kneeland. *Proc. Bost. Soc. Nat. Hist.*, vol. 6, p. 296. Boston, 1859.
296. STARK, R. M.—Notes on a botanical tour through Canada in 1865. *Trans. Bot. Soc. Edin.*, vol. 8, p. 398, 1866.
297. SULLIVANT, WILLIAM S.—*Icones muscorum*, or figures and descriptions of most of those mosses peculiar to Eastern North America which have not been heretofore figured. Cambridge, Mass. and London, Eng., 1864.
298. SUTHERLAND, W.—On the addition of *Cystopteris alpina* (Desv.) to the Arctic Flora. *Trans. Bot. Soc. Edin.*, vol. 7, pp. 393-4, 1863. (Can. ref.)

299. TAYLOR, J.—Notice of flowering plants and ferns collected on both sides of Davis Straits and Baffin's Bay. *Edin. New Phil. Journ.*, vol. 16, pp. 76-87, 1862; *Trans. Bot. Soc. Edin.*, vol. 7, pp. 323-334, 1863.
300. TRAILL, MRS. C. P.—Canadian wild flowers. *Illus. Montreal*, 1869.
301. TUCKERMAN, E.—Genera Lichenum: an arrangement of the North American lichens. Amherst, 1872. (Can. ref.)
302. VERRILL, A. E.—List of plants collected in Anticosti and the Mingan Islands during the summer of 1861. *Proc. Bost. Soc. Nat. Hist.*, vol. 9, pp. 146-152, 1862.
303. WATSON, S.—Revisions of the extra-tropical North American species of the Genera *Lupinus*, *Potentilla*, and *Oenothera*. *Proc. Amer. Acad. Arts and Sc.*, vol. 8, pp. 517-618, 1873. (Can. ref.)
304. WATSON, S.—Revision of the North American *Chenopodiaceae*. *Proc. Amer. Acad. Arts and Sc.*, vol. 9, pp. 82-126, 1874. (Can. ref.)
305. WATT, D. A. P.—Provisional catalogue of Canadian cryptogams. *Can. Nat. and Geo.*, vol. 2, n. ser., pp. 390-404, Oct. 1865.
306. WATT, D. A. P.—Botanical notes. Montreal, 1869.
307. WATT, D. A. P.—Acrogens of Lake Superior. *Can. Nat. (II)*, vol. 4, pp. 362-370, 1869.
308. WILLEY, HENRY—A list of North American lichens. New Bedford, Mass., Ja. 1873.
309. WOOD, H. C.—A contribution to the history of the fresh-water algae of North America. *Smiths. Cont. Knowl.* 19-(3), sect. 1-8, pp. 1-262, pl. 1-21, 1874. *Am. Jour. Sc. Arts (3)*, vol. 5, p. 391, 1873; *Grevillea*, vol. 2, pp. 54-57, 72-76, 92-96, 1873.

SECTION IV. 1876-1900

310. ACHESON, G.—Biological study of the tap-water in the School of Practical Science, Toronto, 1883. *Proc. Can. Inst.*, vol. 1, p. 413, 1884.
311. ALLEN, J. A.—Alpine flora of the Province of Quebec. *Can. Nat. (II)*, vol. 10, pp. 417-419, 1883.
312. ALLEN, T. F.—The *Characeae* of America, pp. 14, pl. 1-6. Boston, 1880.
313. ALLEN, T. F.—Notes on the *Characeae* of Lawlor's Lake Lacustrine Formations of Torryburn Valley. *Bul. Nat. Hist. Soc. N.B.*, vol. 1, pp. 14-15, f. 1-22, 1883.

314. ALLEN, T. F.—The Characeae of America, part I, pp. 64, 55 f., 8°, New York, 1888.
315. ALLEN, T. F.—The Characeae of America, Part II, pp. 19-28, 10 pl., 1896.
316. AMERICAN ASSOCIATION FOR ADVANCEMENT OF SCIENCE—Proceedings of the Botanical Club, A.A.A.S. Buffalo meeting, August 25-29, 1896. Bul. Tor. Bot. Club, vol. 23, pp. 350-362, 1896. (Can. ref.)
317. AMI, HENRY M.—On the occurrence of *Sherardia arvensis* L. in Canada. Bul. Tor. Bot. Club, vol. 14, p. 14, 1887.
318. AMI, H. M.—Flora Temiscouatensis. Bul. Tor. Bot. Club, vol. 15, pp. 134-136, 1888.
319. AMI, H. M.—Notes on the Flora of Montebello, Quebec. Can. Rec. Sc., vol. 3, pp. 315-318, 1889. Reprinted.
320. AMI, H. M.—Flora Ottawaensis. Ottawa Nat., vol. 3, p. 4, 1889.
321. ANDERSON, A. C.—Vegetation of British Columbia. Can. Nat., n. ser., vol. 8, p. 148, 1878.
322. ARNOLD, F.—Labrador. Pamphlet, pp. 18. Munich, 1896. (Contains 127 species of lichens).
323. ARNOLD, F.—Lichenologische Fragmente 35. Newfoundland. Oesterreich. Bot. Zeitsch., vol. 46, pp. 128-131, 176-182, 213-220, 245-251, 286-292, 326-332, 359-363, 1896.
324. ARTHUR, J. C. & HOLWAY, E. W. D.—Violet Rusts of North America. Minn. Bot. Stud., vol. 2, pp. 631-641, pl. 47, 1900. (Can. ref.)
325. ATKINSON, G. F.—Studies of American Fungi—Mushrooms, edible, poisonous, etc., vol. 1-4, pp. 1-275, pl. 176, f. 1-222, Ithaca, N.Y., 1900.
326. BAILEY, LORING WOART—A preliminary synopsis of North America carices. Proc. Amer. Acad., vol. 22, pp. 59-157, 1887 (?).
327. BAILEY, L. W.—Notes on Carex-XVII. Bul. Tor. Bot. Club, vol. 20, pp. 417-426, 1893. (Gives some Canadian localities).
328. BAILEY, L. W.—Woods and Minerals of New Brunswick, being a descriptive catalogue prepared for use at the Philadelphia Exhibition by L. W. Bailey and Edward Jack. Fredericton, 1876.
329. B, L. W.—Notes on the Diatomaceae from the St. John River. Can. Nat., vol. 8, p. 92, 1878 (?).
330. BAILEY, L. W.—Elementary Natural History, with special reference to the minerals, plants and animals of New Brunswick. St. John, 1887.
331. BAIN, FRANCIS—The Natural History of Prince Edward Island. Charlottetown, 1890. (Includes geology, botany and zoology.)

332. BALL, REV. EDWARD H.—Indigenous ferns of Nova Scotia. Proc. N. S. Inst. Nat. Sc., vol. 4, p. 146; vol. 5, p. 13, 1876-1879 (?).
333. BAPTIE, GEO.—*Monotropia uniflora* a parasite? Ottawa Nat., vol. 1, pp. 40-43, 1887.
334. BARKER, —.—*Petalonema alatum* Berkeley, from the falls of Niagara, exhibited. Quart. Jour. Mic. Sc., n. ser., vol. 17, p. 561, 1877.
335. BARNES, C. R.—Artificial keys to the genera and species of mosses recognized in Lesquereux and James's Manual of the Mosses of North America. Trans. Wisconsin Acad. Sc. Arts and Letters, vol. 8, pp. 11-81, 1890.
336. BARNES, C. R.—Analytic keys to the genera and species of North American Mosses. Bul. Univ. Wisconsin, Science Series, vol. 1, pp. 157-368, 1896. (Can. ref.)
337. BARNHART, J. H.—*Ulmaria Ulmaria* (L). Bul. Tor. Bot. Club, vol. 21, p. 491, 1894. (Can. ref.)
338. BARNSTON, G.—On a collection of plants from Br. Columbia made by James Richardson in 1874. Can. Nat. (II), vol. 8, pp. 90-94, 1878.
339. BEAL, W. J.—Grasses of North America. Vol. 1, 1887, vol. 2, 1896; 2 ed., vol. 1, 1896.
340. BELL, ROBERT—The northern limits of the principal forest trees of Canada east of the Rocky Mountains, with map of distribution. Geol. Surv. of Canada, 1879-80.
341. BELL, R.—The geographical distribution of the forest trees of Canada, pp. 21. Montreal, 1882. From Geological Survey for 1880.
342. BELL, R.—The Forests of Canada. Can. Rec. Sc., vol. 2, p. 65, 1886 (?).
343. BERKELEY, M. J.—Enumeration of the fungi collected during the Arctic expedition 1875-6. Jour. Linn. Soc., vol. 17, pp. 13-17, 1880.
344. BESSEY, C. E.—Botany at the Amer. Ass. Adv. Sc. (Toronto). Amer. Nat., vol. 23, pp. 816-9, 1890 (?).
345. BEST, G. N.—*Orthotrichum gymnostomum* Bruch. Bul. Tor. Bot. Club, vol. 21, pp. 527-8, 1894. (Newfoundland ref.)
346. BEST, G. N.—Revision of the North American Thuidiums. Bul. Tor. Bot. Club, vol. 23, pp. 78-90, 1896. (Can. ref.)
347. BEST, G. N.—Revision of the Claopodiums. Bul. Tor. Bot. Club, vol. 24, pp. 427-432, 1897. (Can. ref.)
348. BEST, G. N.—Revision of the North American species of *Pseudoleskea*. Bul. Tor. Bot. Club, vol. 27, pp. 221-236, 2 pl., 1900. (Can. ref.)

349. BICKNELL, E. P.—*Hypericum boreale* (Britton) and related species. Bul. Tor. Bot. Club, vol. 22, pp. 211-215, 1895. (Can. ref.)
350. BICKNELL, E. P.—The genus *Sanicula* in the eastern United States with descriptions of two new species. Bul. Tor. Bot. Club, vol. 22, pp. 351-361, 1895. (Can. ref.)
351. BICKNELL, E. P.—A neglected *Carex*. Bul. Tor. Bot. Club, vol. 23, pp. 92-95, 1896. (Can. ref.)
352. BICKNELL, E. P.—The blue-eyed grasses of the eastern United States. (Genus *Sisyrinchium*). Bul. Tor. Bot. Club, vol. 23, pp. 130-137, pl. 263-5, 1896. (Can. ref.)
353. BICKNELL, E. P.—The North American species of *Agrimonia*. Bul. Tor. Bot. Club, vol. 23, pp. 508-523, 1896. (Can. ref.)
354. BICKNELL, E. P.—A new species of Wild Ginger hitherto confounded with *Asarum canadense* L. Bul. Tor. Bot. Club, vol. 24, pp. 528-536, pl. 2, 1897. (Can. ref.)
355. BICKNELL, E. P.—Studies in *Sisyrinchium*, III: *S. angustifolium* and some related species new and old. Bul. Tor. Bot. Club, vol. 26, pp. 335-349, 1899. (Can. ref.)
356. BICKNELL, E. P.—Studies in *Sisyrinchium*, IV. Bul. Tor. Bot. Club, vol. 26, pp. 445-457, 1899. (Can. ref.)
357. BICKNELL, E. P.—Studies in *Sisyrinchium*, VII: The species of British America. Bul. Tor. Bot. Club, vol. 27, pp. 237-246, 1900.
358. BICKNELL, E. P.—Studies in *Sisyrinchium*, VIII: *Sisyrinchium californicum* and related species of the neglected genus *Hydastylus*. Bul. Tor. Bot. Club, vol. 27, pp. 373-387, 1900. (Can. ref.)
359. BORNET, E.—Florule des Iles Saint Pierre et Miquelon. Jour. de Bot., vol. 1, pp. 180-186, 219-221, 234-239, 249-253, 260-266, 1888.
360. BOUGHAN, L. J.—Notes on the Flora of Long Point Islands, Lake Erie, Prov. Ontario, Can. Ottawa Nat., vol. 12, p. 105, 1898.
361. BRITTON, E. G.—Contributions to American Bryology, IV. Notes on the North American species of *Orthotrichum*, II. Bul. Tor. Bot. Club, vol. 21, pp. 1-15, 1894. (Can. ref.)
362. BRITTON, E. G.—Contributions to American Bryology, V. Notes on the North American species of *Weissia* (*Ulota*). Bul. Tor. Bot. Club, vol. 21, pp. 65-76, 1894. (Can. ref.)
363. BRITTON, E. G.—Contributions to American Bryology, VI. I. Western species of *Orthotrichum*. Bul. Tor. Bot. Club, vol. 21, pp. 137-159, 1894. (Can. ref.)
364. BRITTON, E. G.—Supplementary Notes on the North American

- species of *Weissia* (*Ulota*). *Bul. Tor. Bot. Club*, vol. 21, pp. 159-160, 1894. (Can. ref.)
365. BRITTON, E. G.—Contributions to American Bryology, VII. *Bul. Tor. Bot. Club*, vol. 21, pp. 189-208, 1894. (Can. ref.)
366. BRITTON, E. G.—Contributions to American Bryology, IX. *Bul. Tor. Bot. Club*, vol. 22, pp. 36-43, 1895. (Can. ref.)
367. BRITTON, E. G.—Contributions to American Bryology, XI. *Bul. Tor. Bot. Club*, vol. 22, pp. 447-458, 1895. (Can. ref.)
368. BRITTON, E. G.—A revision of the North American species of *Ophioglossum*. *Bul. Tor. Bot. Club*, vol. 24, pp. 545-559, 1897. (Can. ref.)
369. BRITTON, E. G.—Bryological Notes, I. *Bul. Tor. Bot. Club*, vol. 27, pp. 648-649, 1900. (Can. ref.)
370. BRITTON, N. L.—A list of plants collected by Mr. J. Albert Rudkin on a trip to Mt. St. Elias in the summer of 1883. *Bul. Tor. Bot. Club*, vol. 11, p. 36, 1884. (Can. ref.)
371. BRITTON, N. L.—A list of the State and local floras of the U.S. and British America. *Contr. Herb. Columbia Coll.* No. 14, 1890. *Annals of the N.Y. Acad. Sc.*, vol. 5, 1889-91.
372. BRITTON, N. L.—*Eleocharis*, the genus in North America. *Jour. N. Y. Mic. Soc.*, vol. 5, pp. 95-111, 1890 (?).
373. BRITTON, N. L.—New or noteworthy North American Phanerogams, III. *Bul. Tor. Bot. Club*, vol. 17, pp. 310-316, 1890. (Contains some Canadian species).
374. BRITTON, N. L.—New or noteworthy North American Phanerogams, IV. *Bul. Tor. Bot. Club*, vol. 18, pp. 265-272, 1891. (Can. ref.)
375. BRITTON, N. L.—New or noteworthy North American Phanerogams, V. *Bul. Tor. Bot. Club*, vol. 18, pp. 363-370, 1891. (Can. ref.)
376. BRITTON, N. L.—New or noteworthy North American Phanerogams, VI. *Bul. Tor. Bot. Club*, vol. 19, pp. 219-226, 1892. (Can. ref.)
377. BRITTON, N. L.—American species of the genus *Anemone* and the genera which have been referred to it. *Annals N.Y. Acad. Sc.*, vol. 6, pp. 215-238, *Contr. Herb. Colum. Coll.* No. 23, 1892 (?).
378. BRITTON, N. L.—List of species of the genera *Scirpus* and *Rhynchospora* occurring in North America. *Trans. N.Y. Acad. Sc.*, vol. 11, pp. 74-93. *Contr. Herb. Colum. Coll.* No. 26, 1892 (?).
379. BRITTON, N. L.—New or noteworthy North American Phanero-

- gams, VII. Bul. Tor. Bot. Club, vol. 20, pp. 277-282, 1893. (Includes *Rubus setosus* Bigel. in Quebec).
380. BRITTON, N. L.—New or noteworthy North American Phanerogams, VIII. Bul. Tor. Bot. Club, vol. 21, pp. 27-34, 1894. (Can. ref.)
381. BRITTON, N. L.—A Revision of the genus *Lechea*. Bul. Tor. Bot. Club, vol. 21, pp. 244-253, 1894. (Can. ref.)
382. BRITTON, N. L.—New or noteworthy North American Phanerogams, IX. Bul. Tor. Bot. Club, vol. 22, pp. 220-225, 1895. (Can. ref.)
383. BRITTON, N. L.—Two undescribed eastern species. Bul. Tor. Bot. Club, vol. 24, pp. 92-93, 1897. (Can. ref.)
384. BRITTON, N. L.—La flore du Klondike. Act. Congrès Internat. Bot. Paris, p. 270, 1900.
385. BRITTON, N. L. & BROWN, A.—An illustrated flora of the Northern United States, Canada, and the British Possessions. Vol. 1, New York, 1896; vol. 2, New York, 1897; vol. 3, New York, 1898. 2nd ed., vols. 1-3, New York, 1913.
386. BRITTON, N. L. & COX, P.—Botanical Report. Bul. Nat. Hist. Soc. N.B., vol. 8, p. 119, 1893 (?).
387. BRUNCKEN, E.—North American forests and forestry. New York, and London, 1900.
388. BULYEA, G. H. V., PETERSON, C. W. & WILLING, T. W.—Noxious weeds and how to destroy them. Bulletin No. 2. Government of the North-West Territories, Dept. of Agriculture. 1900.
389. BURGESS, THOMAS JOSEPH WORKMAN—Botanical notes from Canada. Bot. Gaz., vol. 7, 1882.
390. BURGESS, T. J. W.—A botanical holiday in Nova Scotia. Bot. Gaz., vol. 9, 1884.
391. BURGESS, T. J. W.—Canadian Filicineae, by J. Macoun and T. J. W. Burgess, M.D. Trans. Roy. Soc. Can., vol. 4 (II), p. 163, 1885 (?).
392. BURGESS, T. J. W.—*Aspidium oreopteris*. Bot. Gaz., vol. 11, 1886.
393. BURGESS, T. J. W.—Recent additions to Canadian Filicineae. Trans. Roy. Soc. Can., vol. 4, sec. 4, pp. 9-18, 1886.
394. BURGESS, T. J. W.—Orchids. Jour. and Proc. Hamilton Assoc., 1887.
395. BURGESS, T. J. W.—How to study Botany. Jour. and Proc. Hamilton Assoc., 1887.
396. BURGESS, T. J. W.—Notes on the Flora of the 49th parallel from Lake of the Woods to the Rocky Mountains. Jour. and Proc. Hamilton Assoc., 1887-88.

397. BURGESS, T. J. W.—The Lake Erie shore as a botanizing ground. Reprint 8°, pp. 41-59. Read before the biological section of the Hamilton Association Feb. 15, 1889.
398. BURGESS, T. J. W.—Notes on the History of Botany. Jour. and Proc. Hamilton Assoc., 1889-90.
399. BURGESS, T. J. W.—Ophioglossaceae and ferns. Cat. Can. Plants, Macoun, part V, p. 253, 1890.
400. BURGESS, T. J. W.—Notes on Genus Rhus. Jour. and Proc. Hamilton Assoc., 1891-92.
401. CAMPBELL, G. G.—List of plants collected in the neighbourhood of Truro during the summers of 1883-4. Proc. Trans. N. S. Inst. Nat. Sc., vol. 6, pp. 209-225, 1885.
402. CAMPBELL, G. G.—Supplementary list of Plants collected in the summer of 1885. Proc. Trans. N. S. Inst. Nat. Sc., vol. 6, pp. 283-5, 1886.
403. CAMPBELL, REV. ROBERT—Notes on the flora of Cap-à-l'Aigle, P.Q. Can. Rec. Sc., vol. 4, pp. 54-68, 1890.
404. CAMPBELL, R.—Supplemental Notes on the Flora of Cap-à-l'Aigle, P.Q. Can. Rec. Sc., vol. 5, p. 38, 1892 (?).
405. CAMPBELL, R.—The Flora of Montreal Island. Can. Rec. Sc., vol. 5, p. 208, 1892 (?).
406. CAMPBELL, R.—Changes in the flora of Montreal Island. Can. Rec. Sc., vol. 5, pp. 294-296, 1892.
407. CAMPBELL, R.—Some of the rarer summer flowers of Canada. Can. Rec. Sc., vol. 6, pp. 342-351, 1895.
408. CAMPBELL, R.—Additional notes on the flora of Montreal Island. Can. Rec. Sc., vol. 6, pp. 397-405, 1895.
409. CAMPBELL, R.—Botany in the Island of Montreal. Can. Rec. Sc., vol. 8, pp. 84-90, 1899.
410. CAMPBELL, R.—The flora of the Rocky Mts. Can. Rec. Sc., vol. 8, pp. 163-192, 1900.
411. CAMPBELL, R.—North American Goldenrods. Can. Rec. Sc., vol. 8, pp. 192-195, 1900.
412. CARDOT, JULES—Revision des sphaignes de l'Amérique du Nord. Bull. de la Soc. Roy. de botanique de Belgique, tome 26, première partie, 1887.
413. —
414. CHAPPAIS, J. C.—The Canadian Forester's Illustrated Guide. Pp. 199, Fig. 126. Montreal, 1885.
415. CHICKERING, J. W.—The Canadian Flora. Bul. Tor. Bot. Club, vol. 9, p. 140, 1882. (A short note only).
416. CHRISTISON, SIR R.—Notice of a remarkable Polyporus from Canada. Trans. Bot. Soc. Edin., vol. 12, pp. 180-1, 1876.

417. CHRISTY, R. M.—Notes on the botany of Manitoba. Jour. Bot., vol. 25, pp. 271-6, 290-301, 1887.
418. CLAYPOLE, K. B.—Notes on some of the plants found in Muskoka Lake, Sept. 1, 1889. Bul. Tor. Bot. Club, vol. 17, pp. 101-2, 1890.
419. CLEVE, P. T.—Diatoms collected during the Expedition of the Vega. Vega-Expeditionenens Vet. Jakt., vol. 3, Stockholm, 1883; Bot. Centralb., vol. 18, pp. 132-3, 1884. (Behring Sea).
420. CLEVE, P. T.—Diatoms from Baffin's Bay and Davis Strait. Bihang K. Sven. Vet.-Akad. Handl., vol. 22 (4), pp. 1-22, pl. 1-2, 1896.
421. CLEVE, P. T. & GRUNOW, A.—Beiträge zur Kenntniss der arctischen Diatomeen. Akad. Handl., vol. 17, No. 2, 1881.
422. COLLINS, F. S., HOLDEN, I. & SETCHELL, W. A.—Phycotheca Boreali-Americana. Fasc. 1. Malden, 1895.
423. COOK, M. T.—*Myriostoma coliforme*. Bot. Gaz., vol. 23, pp. 43-4, 1897. (Can. ref.)
424. COOLEY, GRACE E.—Impressions of Alaska. Bul. Tor. Bot. Club, vol. 19, 178-189, 1892.
425. COOLEY, G. E.—Plants collected in Alaska and Nanaimo, B.C., July and August, 1891. Bul. Tor. Bot. Club, vol. 19, pp. 238-249, 1892.
426. COULTER, J. M. & ROSE, J. N.—Revision of North American Umbelliferae. Pp. 1-144, pls. 1-9. Crawfordsville, Indiana, 1888. (Can. ref.)
427. COULTER, J. M. & ROSE, J. N.—Monograph of the North American Umbelliferae. Contr. U. S. Nat. Herb., vol. 7, No. 1, pp. 256, 9 pl., 65 figs., 1900. (Can. ref.)
428. COVILLE, F. V.—Botany of Yakutat Bay, Alaska, with a field report by F. Funston. Contr. U. S. Nat. Herb., vol. 3, pp. 325-353, 1896.
429. COVILLE, F. V.—The tree willows of Alaska. Proc. Wash. Acad. Sc., vol. 2, pp. 275-286, pl. 15, 1900.
430. CRAIG, JOHN—A destructive disease affecting native plums. Ottawa Nat., vol. 6, p. 109, 1892.
431. CRAWFORD, W. C.—Notes of a visit to North America, as delegate to the British Association meeting at Montreal, etc. Trans. Proc. Bot. Soc. Edin., vol. 16, pp. 269-272, 1886 (?).
432. CUMMINGS, CLARA E.—Catalogue of Musci and Hepaticae of North America North of Mexico. Pam., pp. 24. Natick, Mass., 1885.
433. CUMMINGS, C. E.—Cryptogams collected by Dr. C. Willard Hayes in Alaska, 1891. Nat. Geogr. Mag., vol. 4, p. 160, 1892 (?).

434. CUSHING, H. B.—On the ferns in the vicinity of Montreal. *Can. Rec. Sc.*, vol. 6, pp. 488-494, 1896.
435. CUSHING, H. B. & CAMPBELL, R.—The Gramineae, Cyperaceae, and Juncaceae of Montreal Island. *Can. Rec. Sc.*, vol. 8, pp. 11-24, 1899.
436. DAWSON, GEO. M.—Note on the distribution of the more important trees of B.C. *Can. Nat.* (II), vol. 9, pp. 321-331, 1880, and in *Rep. Geol. Surv. Can.*, 1879-80, pp. 167-B—177-B, 1881.
437. DAWSON, G. M.—Forest trees of the Far North-West. *Garden and Forest*, vol. 1, pp. 58-9, 1888 (?).
438. DAWSON, SIR JOHN WILLIAM, K.C.M.G.—Notes on trees cultivated on the grounds of McGill University. *Can. Rec. Sc.*, vol. 4, p. 407, 1891 (?).
439. DAWSON, MISS M.—On the anatomical characters of the substance "Indian Soap". *Trans. Can. Inst.*, vol. 7, pp. 1-6, 1 pl., 1900-1. (*Polyporus* sp.)
440. DAY, E. G.—*Stephanodiscus niagarae*. *Journ. N. Y. Mic. Soc.*, vol. 1, pp. 41-2, 1885.
441. DAVENPORT, GEORGE E.—Catalogue of the Davenport Herbarium of North American ferns. Boston, Mass., Dec. 1878.
442. DAVIS, K. C.—A synonymic conspectus of the native and garden Aquilegias of North America. *Minn. Bot. Stud.*, vol. 2, pp. 331-343, 1899. (Can. ref.)
443. DAVIS, K. C.—A synonymic conspectus of the native and garden Aconitums of North America. *Minn. Bot. Stud.*, vol. 2, pp. 345-352, 1899. (Can. ref.)
444. DAVIS, K. C.—Native and garden Delphiniums of North America. *Minn. Bot. Stud.*, vol. 2, pp. 431-457, 1900. (Can. ref.)
445. DAVIS, K. C.—Native and cultivated Ranunculi of North America and segregated genera. *Minn. Bot. Stud.*, vol. 2, pp. 459-507, 1900. (Can. ref.)
446. DAVIS, K. C.—A synonymic conspectus of the native and garden Thalictiums of North America. *Minn. Bot. Stud.*, vol. 2, pp. 509-523, 1900. (Can. ref.)
447. DAY, DAVID F.—Catalogue of the Niagara Flora, 8°, pp. 67, 1888 (?). (Includes Ontario)
448. DAY, D. F.—The A.A.A.S. Botanical Club's trip to the Lakes of Muskoka, Ontario, Aug. 31 to Sept. 2, 1889. *Bul. Tor. Bot. Club*, vol. 16, pp. 285-290, 1889.
449. DAY, D. F.—The new locality for *Subularia aquatica* L. *Bul. Tor. Bot. Club*, vol. 16, pp. 291-3, 1889.
450. DELAMARE, E., RENAULD, F. & CARDOT, J.—Flora Miquelonensis:

- enumeration systématique avec notes descriptives des Phanérogames, Cryptogames vasculaires, Mousses, Sphaignes, Hépatiques et Lichens, 79 pp. Lyons, 1888.
451. DELAMARE, E., RENAULD, F., & CARDOT, J.—Florule de l'Ile Miquelon. Bul. Tor. Bot. Club, vol. 15, pp. 201-202, 1888.
452. DERICK, CARRIE M.—The folk lore of Plants. Can. Rec. Sc., vol. 5, pp. 332-9, 1893 (?).
453. DERICK, C. M.—A few notes on Canadian Plant lore. Can. Rec. Sc., vol. 7, pp. 220-227, 1897.
454. DE TONI, J. B.—Revision of the genus *Doassansia*, Cornu. Jour. Myc., vol. 4, pp. 13-19, Feb. and Mar. 1888. (Can. ref.)
455. DEWEY, L. H.—Botanical Notes. Bul. Tor. Bot. Club, vol. 22, p. 370, 1895. (Can. ref.)
456. DICKIE, G.—On the Algae found during the Arctic Expedition. Jour. Linn. Soc. (Bot.), vol. 17, pp. 6-12, 1880.
457. DICKSON, J. M.—*Trillium grandiflorum* Salisb. Jour. and Proc. Hamilton Association, vol. 15, p. 99, 1899.
458. DICKSON, J. M. & ALEXANDER, A.—Flora of the Hamilton District. Jour. Proc. Hamilton Assoc., vol. 13, pp. 95-127, 1897.
459. DOHERTY, M. W.—New species of *Trimmatostroma*. Bot. Gaz., vol. 30, pp. 400-403, Dec. 1900. (Ontario reference).
460. DRUMMOND, ANDREW THOMAS—Botanical Notes, including additional list of lichens. Can. Nat., n. ser., vol. 7, p. 217, 1876 (?).
461. DRUMMOND, A. T.—Canadian timber trees. Rept. Mont. Hort. Soc., p. 14, 1878.
462. DRUMMOND, A. T.—Forestry in Canada. Rept. Mont. Hort. Soc., p. 30, 1880.
463. DRUMMOND, A. T.—Note on the distribution of the Canadian forests. Can. Mag. Sc., Oct. 1883.
464. DRUMMOND, A. T.—Distribution of Canadian forest trees in its relations to climate and other causes. Can. Economics, 1884.
465. DRUMMOND, A. T.—Articles on Forestry and the Lower St. Lawrence Flora, in the Hand-Book for Canada, published for the British Association Meeting at Montreal, 1884.
466. DRUMMOND, A. T.—Distribution of Canadian forest trees in its relation to climate and other causes. Reprinted from Canadian Economics, Montreal, 1885.
467. DRUMMOND, A. T.—Forest Preservation in Canada. Amer. For. Congress, 1885.
468. DRUMMOND, A. T.—Our Northwest Prairies, their origin and forests. Can. Rec. Sc., vol. 2, p. 145, 1886 (?).

469. DRUMMOND, A. T.—Distribution and physical and past geological relations of British North American plants. *Can. Rec. Sc.*, vol. 2, pp. 412-423, 457-469, 1887; vol. 3, pp. 1-21, 1888 (?).
470. DRUMMOND, A. T.—The colours of flowers in relation to time of flowering. *Can. Rec. Sc.*, vol. 5, pp. 280-284, 1892.
471. EASTWOOD, A.—Key and Flora (to Bergen's Elements of Botany) Rocky Mt. Edition, pp. 1-139, 1900.
472. EATON, A. A.—Two new species. *Bul. Tor. Bot. Club*, vol. 25, pp. 338-341, 1898. (Can. ref.)
473. EATON, A. A.—The genus *Equisetum* with reference to the North American species. *Fern. Bul.*, vol. 7, pp. 57-59, 1899.
474. EATON, D. C.—The ferns of North America. The drawings by J. H. Emerton and C. E. Faxon, 2 vols. Vol. 1, xiv-352, pl. 1-45; vol. 2, xxxi-285, pl. 46-81, 1879-80. (Includes British North American Possessions).
475. EATON, D. C.—A check-list of North American *Sphagna*, arranged mostly in accordance with the writings of Dr. Carl Warnstorf. New Haven, 8°, pp. 10, 1893.
476. EATON, D. C., FARLOW, W. G. & ANDERSON,—Algae *Americae-Borealis, Exsiccatae*, Fasc. 1-5. Boston, 1877-89.
477. ECKFELDT, J. W.—An enumeration of the lichens of Newfoundland and Labrador. *Bul. Tor. Bot. Club*, vol. 22, pp. 239, 260, 1895.
478. ELLIS, JOB BICKNALL—Canadian Fungi. *Jour. Myc.*, vol. 1, pp. 85-87, July 1885.
479. ELLIS, J. B.—Fungi of the Greeley Expedition. (Ellis and Everhart). *Bot. Gaz.*, vol. 10, p. 366, 1885; *Jour. Myc.*, vol. 1, p. 141, 1885.
480. ELLIS, J. B.—North American *Pyrenomycetes*. (Ellis and Everhart), 1892.
481. ELLIS, J. B. & DEARNESS, J.—New species of Canadian Fungi. *Can. Rec. Sc.*, vol. 5, pp. 266-272, 1892.
482. ELLIS, J. B. & DEARNESS, J.—New species of Canadian fungi. *Can. Rec. Sc.*, vol. 6, pp. 267-272, Jan. 1893.
483. ELLIS, J. B. & EVERHART, B. M.—Fungi of the Greeley Expedition. *Bot. Gaz.*, vol. 10, p. 366, 1885; also *Jour. Myc.*, vol. 1, p. 141, 1885. (Includes *Puccinia Cheiranthi* on *C. pygmaeus* from Grinnell Land).
484. ELLIS, J. B. & EVERHART, B. M.—New species of Fungi from various localities. *Jour. Myc.*, vol. 3, pp. 127-130, Nov. 1887. (Can. ref.)
485. ELLIS, J. B. & EVERHART, B. M.—Additions to *Ramularia* and *Cercospora*. *Jour. Myc.*, vol. 4, pp. 1-7, Jan. 1888. (Can. ref.)

486. ELLIS, J. B. & EVERHART, B. M.—Synopsis of the North American species of Hypoxylon and Nummularia. Jour. Myc., vol. 4, pp. 38-44, Apr. and May, 1888; also vol. 4, pp. 85-93, Sept. 1888; vol. 4, pp. 109-113, Nov. 1888. (Can. ref.)
487. ELLIS, J. B. & EVERHART, B. M.—New species of Fungi from various localities. Jour. Myc., vol. 4, pp. 49-59, June 1888. (Can. ref.)
488. ELLIS, J. B. & EVERHART, B. M.—Synopsis of the North American species of Nummularia and Hypoxylon. Jour. Myc., vol. 5, pp. 19-23, 1889. (Can. ref.)
489. ELLIS, J. B. & EVERHART, B. M.—Some new species of Hymenomycetous fungi. Jour. Myc., vol. 5, pp. 24-29, 1889. (Can. ref.)
490. ELLIS, J. B. & EVERHART, B. M.—New species of Hyphomycetous fungi. Jour. Myc., vol. 5, pp. 68-72, 1889. (Can. ref.)
491. ELLIS, J. B. & EVERHART, B. M.—New and rare species of North American fungi (Sphaeropsidae). Jour. Myc., vol. 5, pp. 145-157, 1889. (Can. ref.)
492. ELLIS, J. B. & EVERHART, B. M.—*Leptothyrium Periclymeni* Desm. Jour. Myc., vol. 6, p. 116, 1890. (Can. ref.)
493. ELLIS, J. B. & EVERHART, B. M.—New species of Uredineae and Ustilagineae. Jour. Myc., vol. 6, pp. 118-121, 1890. (Can. ref.)
494. ELLIS, J. B. & EVERHART, B. M.—New species of fungi. Jour. Myc., vol. 7, pp. 130-135, 1892. (Can. ref.)
495. ELLIS, J. B. & EVERHART, B. M.—New fungi, mostly Uredineae and Ustilagineae from various localities, and a new Fomes from Alaska. Bul. Tor. Bot. Club, vol. 22, pp. 362-364, 1895.
496. ELLIS, J. B. & EVERHART, B. M.—New species of fungi from various localities. Bul. Tor. Bot. Club, vol. 24, pp. 125-137, 1897. (Can. ref.)
497. ELLIS, J. B. & EVERHART, B. M.—New species of North American Fungi from various localities. Bul. Tor. Bot. Club, vol. 24, pp. 277-292, 1897. (Can. ref.)
498. ELLIS, J. B. & EVERHART, B. M.—New species of fungi from various localities. Bul. Tor. Bot. Club, vol. 24, pp. 457-477, 1897. (Can. ref.)
499. ELLIS, J. B. & EVERHART, B. M.—New species of fungi from various localities. Bul. Tor. Bot. Club, vol. 25, pp. 501-514, 1898. (Can. ref.)
500. ELLIS, J. B. & EVERHART, B. M.—New species of fungi from various localities with notes on some published species. Bul. Tor. Bot. Club, vol. 27, pp. 49-64, 1900. (Can. ref.)

501. ELLIS, J. B. & EVERHART, B. M.—New species of fungi from various localities. *Bul. Tor. Bot. Club*, vol. 27, pp. 571-578, 1900. (Can. ref.)
502. ELLIS, J. B. & EVERHART, B. M.—The North American Phyllostictas with descriptions of the species published up to Aug. 1900, pp. 1-79. Vineland, N.J., 1900.
503. EVANS, A. W.—A revision of the North American species of *Frullania*, a genus of Hepaticae. *Trans. Conn. Acad.*, vol. 10, pp. 1-39, pl. 1-15, 1897.
504. EVANS, A. W.—List of Hepaticae collected along the International Boundary by J. M. Holzinger, 1897. *Minn. Bot. Studies*, vol. 2, p. 193, 1899.
505. EVANS, A. W.—Papers from the Harriman Alaska Expedition. V. Notes on the Hepaticae collected in Alaska. *Proc. Wash. Acad. Sc.*, vol. 2, pp. 287-314, pl. 16-18, 1900.
506. EVANS, W. H.—The Agricultural Outlook of the coast region of Alaska. *Yearbook U.S. Dept. Agr.* 1897, pp. 553-576, pl. 32-35, 1898 (mentions plants).
507. EVANS, W. H.—An undescribed Birch from Alaska. *Bot. Gaz.*, vol. 27, pp. 481-482, 1899.
508. EVANS, W. H.—Notes on the edible berries of Alaska. *Plant World*, vol. 3, pp. 17-19, 1900.
509. FAIRWEATHER, WM.—Noxious weeds and methods of destroying them. 4th Ann. Rep. of the Supt. of Farmers' Institutes of Ontario, for the year 1897-8. Pp. 84-86, 1898.
510. FARLOW, WILLIAM GILSON—List of Algae collected at points in Cumberland Sound during the autumn of 1877. Contribution to the natural history of Arctic America made in connection with the Howgate Polar Expedition. *Bul. U.S. Nat. Mus.*, vol. 15, p. 169, 1879.
511. FARLOW, W. G.—Marine Algae of the New England and adjacent coast. Washington, 1881.
512. FARLOW, W. G.—Notes on a fungus parasitic on species of *Potamogeton*. *Trans. Ottawa, Field Nat. Club*, vol. 2, pp. 127-9, 1884.
513. FARLOW, W. G.—Notes on Arctic Algae: based principally on collections made at Ungava Bay by Mr. L. M. Turner in 1884. *Proc. Amer. Acad. Arts Sc.*, vol. 22, pp. 469-477, 1886; *Jour. Roy. Mic. Soc.*, 1887, p. 268, April, 1887.
514. FARLOW, W. G.—A supplemental list of works on North American fungi. *Library of Harvard University Bibliographical Contributions*, No. 31. Cambridge, 1888.
515. FARLOW, W. G. & TRELEASE, W.—A list of works on North

- American fungi. Library of Harvard University Bibliographical Contributions, No. 25. Cambridge, 1887.
516. FERNALD, M. L.—Illustrated flora of the Northern States and Canada. Reprint, Amer. Jour. Sc., vol. 6, pp. 277-284, 1898.
517. FERNALD, M. L.—Some plants from the Northwest shore of the Hudson Bay. Four rare plants from Alaska. Ottawa Nat., vol. 13, pp. 147-9, 1899.
518. FERNALD, M. L.—*Arceuthobium pusillum* in the St. John and St. Lawrence Valleys. Rhodora, vol. 2, pp. 10-11, 1900.
519. FERNALD, M. L. & SORNBORGER, J. D.—Some recent additions to the Labrador flora. Ottawa Nat., vol. 13, No. 4, pp. 89-107, July 1899.
520. FINK, B.—Contributions to a knowledge of the Lichens of Minnesota. I. Lichens of Lake of the Woods. Minn. Bot. Studies, vol. 1, pp. 693-701, 1896. (Can. ref.).
521. FITZGIBBON, AGNES—Canadian Wild Flowers painted and lithographed with botanical descriptions, by C. P. Traill. Pp. 88, 10 coloured plates, 4th ed. imp. 4to. Toronto, 1895.
522. FLETCHER, JAMES—Flora Ottawaensis. From Field Naturalist's Club, pp. 15, 1880.
523. FLETCHER, J.—Additions to the Flora Ottawaensis. Ottawa Nat., vol. 1, p. 77, 1887.
524. FLETCHER, J.—Flora Ottawaensis. Ottawa Nat., vol. 2, pp. 28-32, 61-64, 77-80, etc., 1888-1889.
525. FLETCHER, J.—Flora Ottawaensis. Supplementary to Bul. Ottawa Nat. Field Club, vol. 2, 1888; vol. 4, 1890.
526. FLETCHER, J.—Flora Ottawaensis, pp. 101. Ottawa, Can., 1888-93 (not completed).
527. FLETCHER, J.—Flora Ottawaensis. Ottawa Nat., vol. 2, pp. 42-45, 1889.
528. FLETCHER, J.—Flora Ottawaensis. Ottawa Nat., vol. 3, pp. 70-77, 1890.
529. FLETCHER, J.—*Camassia esculenta* and *Camassia Leichtlinii* bulbs from B.C. C.E.F. Report, p. 157, 1890.
530. FLETCHER, J.—Grasses. C.E.F. Report, pp. 178-188, pl. IX, 1890.
531. FLETCHER, J.—Educational Value of Botanic Gardens. Ottawa Nat., vol. 5, p. 105, 1891.
532. FLETCHER, J.—Grasses. C.E.F. Report, pp. 207-213, 1891.
533. FLETCHER, J.—Weeds of the Farm. C.E.F. Report, pp. 213-220, 1891.

534. FLETCHER, J.—Collecting Botanical Specimens. Nor'west Farmer (Winnipeg), p. 196, 1892.
535. FLETCHER, J.—Weeds. C.E.F. Report, pp. 147-148, 1892.
536. FLETCHER, J.—*Lewisia rediviva* in B.C.(?). C.E.F. Report, p. 148, 1892.
537. FLETCHER, J.—Lawn Grasses and Fodder Plants. C.E.F. Report, pp. 164-7, 1892.
538. FLETCHER, J.—Evidence of Mr. James Fletcher, Entomologist and Botanist before the select standing Committee of the House of Commons, on Agriculture and Colonization, session of 1892, pp. 19, printed by order of Parliament. (Mentions Canadian Weeds).
539. FLETCHER, J.—Grass for the protection of shores and harbours. C.E.F. Report, pp. 190-192, 1893.
540. FLETCHER, J.—Tumble Weeds. C.E.F. Report, pp. 192-193, 1893.
541. FLETCHER, J.—The Russian Thistle or Russian Tumble-weed. Experimental Farm Notes, No. 4, pp. 6, 1 Fig. Ottawa, 1894.
542. FLETCHER, J.—Noxious weeds of Manitoba and how to destroy them. Dept. Agr. and Immigr., Manitoba, pp. 1-40, 1896.
543. FLETCHER, J.—Weeds. Bulletin No. 28, Central Experimental Farm, July, 1897.
544. FLETCHER, J.—Botanical Notes. Ottawa Nat., vol. 13, pp. 75-76, 1899.
545. FLETCHER, J.—Manitoba's Wild Flowers. Ottawa Nat., vol. 14, pp. 19-20, 1900.
546. FLETCHER, J. & OTHERS—Flora Ottawaensis. Trans. Ottawa Field Nat. Club, No. 1, pp. 48-61, 1880; No. 2, p. 41, 1881; No. 3, p. 23, 1882; No. 4, p. 73, 1883; No. 5, pp. 29-37 and 126-127, 1884; No. 7, p. 363, 1887.
547. FLETCHER, J. & OTHERS—Flora Ottawaensis. Additions made since last report. Ottawa Nat., vol. 5, p. 204, 1892.
548. FLETCHER, J. & SHUTT, F. T.—Grasses, their uses and composition. Bulletin No. 19, Central Experimental Farm, Ottawa, Sept. 1893.
549. FLETCHER, J. & SMALL, H. B.—Report of the Botanical Branch (of the Ottawa Field Naturalist's Club) for 1888-9. Ottawa Nat., vol. 2, pp. 152-154, 1889.
550. FLETCHER, J., WHYTE, R. B., & SCOTT, W.—Report of the Botanical Branch, 1890. Ottawa Nat., vol. 5, pp. 80-84, 1891.
551. FOWLER, REV. JAMES—List of New Brunswick Plants. Report of the Secretary for Agriculture, Appendix B, pp. 36-63, 1878. (1069 sp. All groups except Algae).

552. FOWLER, J.—Additions to the list of New Brunswick Plants. Rep. of the Secretary for Agriculture, pp. 1-16, 1879. Published Fredericton, Jan. 1880. (Includes some Algae in addition to other groups).
553. FOWLER, J.—List of New Brunswick Plants. Educational Circular No. 9, pp. 44-68; No. 11, pp. 280-284; No. 14, pp. 654-657 and in Bul. Nat. Hist. Soc. N.B., vol. 6, pp. 80-83, 1880.
554. FOWLER, J.—Preliminary list of the plants of New Brunswick. Bul. Nat. Hist. Soc. N.B., vol. 4, pp. 8-85, 1885.
555. FOWLER, J.—Arctic Plants growing in New Brunswick, with notes on their distribution. Proc. Trans. Roy. Soc. Can., 1887, sec. 5, vol. 4, pp. 189-205, 1888.
556. FOWLER, J.—Catalogue of Plants collected at St. Andrews, New Brunswick. Proc. Nat. Hist. Assoc. Miramichi, New Brunswick, vol. 2 (2), pp. 21-28, Dec. 1900.
557. FREAM, W.—Prairie Flowers I, II. Bell's Weekly Messenger and Farmers' Journal, June 3 and June 10, 1889. (Deals with Manitoba and North-West).
558. FREYN, J. VON—Ranunculaceae aus dem westlichen Nordamerika, gesammelt im Auftrage Dr Dieck's, Zoschen bestimmt. Deutsche Bot. Monats., vol. 8, pp. 73-79, 1891 (?). (Incl. B.C.).
559. FYLES, REV. THOMAS W.—The Forests of the Eastern Townships. Proc. Amer. Forest Assoc., Montreal, 1882.
560. GANONG, WILLIAM FRANCIS—On raised peat bogs in New Brunswick. Bot. Gaz., vol. 16, pp. 123-126, 1891.
561. GANONG, W. F.—An outline of Phyto-biology, with special reference to the study of its problems by local botanists, and suggestions for a biological survey of Acadian plants. Bul. N.B. Nat. Hist. Soc., 1894, vol. 3, 1895.
562. GANONG, W. F.—Upon raised Peat bogs in the province of New Brunswick. Trans. Roy. Soc. Canada vol. 2, sec. 3, pp. 131-163, f. 1-9, 1897.
563. GANONG, W. F.—On halophytic colonies in the interior of New Brunswick. Bul. Nat. Hist. Soc. N.B., vol. 16, pp. 50-52, 1898.
564. GIBB, C.—Ornamental and timber trees not natives of the Province of Quebec. Report Montreal Horticultural and Fruit Grower's Assoc., pp. 77, Montreal, 1882.
565. GIBB, C.—Ornamental Trees of Canada. Garden, vol. 30, pp. 492-493, 1887 (?).
566. GIBSON, J. & MACOUN, J.—The plants of the Eastern Coast of

- Lake Huron and their distribution through the northern and western portions of British North America, n.d., 23 pp. (Pamphlet after 1875, reprinted from Can. Jour.)
567. GLENDINNING, H.—Weeds on the Farm. 4th Ann. Report of the Superintendent of Farmers' Institutes of Ontario for the year 1897-8, pp. 86-87, 1898.
568. GOLDIE, J.—Diary of a journey through Upper Canada and some of the New England States 1819. Toronto, 1897. (Some notes on plants).
569. GOOD, J. B.—Notes on Canadian Ferns. Can. Nat., vol. 2, ix, pp. 49-52, 297-302, 1881.
570. GOODALE, GEO. L.—The problem of Heather in North America. Garden and Forest, vol. 3, pp. 62-63, 1890 (?).
571. GOODALE, G. L.—List of mosses collected in the neighbourhood of Ottawa. Ottawa Nat., vol. 3, pp. 149-152, 1890.
572. GORMAN, M. W.—Economic Botany of South-Eastern Alaska. Pittonia, vol. 3, pp. 64-85, 1896.
573. GRATACAP, L. P.—Notes from the Saguenay River. Bul. Tor. Bot. Club, vol. 12, pp. 188-190, 1885.
574. GRAVES, J. A.—The Pteridophyta of North America, north of Mexico. Linnaean Fern Bul. vol. 9, p. 23. Binghampton, 1895.
575. GRAY, ASA—Synoptical Flora of North America, vol. 1, part I, Camb., 1895; vol. 1, part II, New York, 1884; vol. 2, part I, New York, 1878.
576. GRAY, A.—Notes upon the plants collected on the Commander Islands by Leonard Stejneger. Proc. U.S. Nat. Mus., vol. 7, pp. 527-529, 1885.
577. GRAY, A.—Flora of North America, Gamopetalae. Smith. Misc. Coll., vol. 31, pp. 984. Washington, 1886.
578. GRAY, A.—Plates prepared between the years 1849 and 1859 to accompany a report on the forest trees of North America. 63 pl. Washington, 1891.
579. GRAY, A., WATSON, S., & ROBINSON, B. L.—Synoptical Flora of North America. Vol. 1, part I, fasc. 1, 1895. (Includes 1 Ranunculaceae to 17 Frankeniaceae).
580. GRAY, A. & OTHERS—Synoptical Flora of North America. Vol. 1, part I, fasc. II. (Caryophyllaceae to Polygalaceae), 1897.
581. GREELEY, ADOLPHUS WASHINGTON—Three years of Arctic service. London, 1886.
582. GREELEY, A. W.—Botany of the United States expedition to Lady Franklin Bay, Grinnell Lake. Report Proc. Internat. Polar Exp., vol. 2, pp. 11-18, 1888.

- 583 GREENE, E. L.—Illustrations of West America Oaks. Drawings by Albert Kellogg. Text by E. L. Greene, San Francisco, 1889-90. (Some Canadian references).
584. GREENE, E. L.—Distribution of *Rhamnus* in North America, II. *Erythea*, vol. 4, pp. 133-136, 1896.
- 585 GREENE, E. L.—Some Canadian Violets. *Pittonia*, vol. 3, pp. 333-338, 1898.
586. GROUT, A. J.—A preliminary revision of the North American Isotheciaceae. *Bul. Tor. Bot. Club*, vol. 23, pp. 223-233, 1896. (Can. ref.)
587. GROUT, A. J.—A revision of the North American Isotheciaceae and *Brachythecia*. *Mem. Tor. Bot. Club*, vol. 6, pp. 131-210, 1897.
588. GROUT, A. J.—A revision of the North American Eurhynchia. *Bul. Tor. Bot. Club*, vol. 25, pp. 221-256, 1898. (Can. ref.)
589. GROUT, A. J.—A revision of the North American species of *Scleropodium*. *Bul. Tor. Bot. Club*, vol. 26, pp. 531-540, 1899. (Can. ref.)
590. GUIGNARD, JONATHAN AUGUSTE—Sur la fécondation du *Calopogon pulchellus*. *Le Nat. Can.*, vol. 13, p. 271, 1880 (?).
591. GUIGNARD, J. A.—Sur la fécondation des *Cyripedes*. *Le Nat. Can.*, vol. 13, pp. 221, 269-270; vol. 15, p. 94, 1880-1882 (?).
592. GUIGNARD, J. A.—Insects and Orchids. 14th Ann. Rept. Ent. Soc. Ont., pp. 39-40, 1886.
593. HARDY, CAMPBELL—Nova Scotian Conifers. *Trans. N.S. Inst. Nat. Sc.*, vol. 1, iv, p. 120, 1863 (?).
594. HARRISON, F. C.—The Weeds of Ontario. Pp. 1-80, Fig. 1-34. Toronto, 1900.
595. HARRISON, F. C. & DAY, G. E.—Grasses of Ontario. *Ont. Agr. Col. and Exp. Farm. Bul.* 99, 1895.
596. HARRISON, F. C. & LOCHHEAD, W.—The Weeds of Ontario. *Ont. Agr. Col. and Exp. Farm. Bul.* 128, 1903.
597. HART, H. C.—On the Botany of the British Polar Expedition of 1875-1876. *Jour. Bot. n. ser.*, vol. 9, 1880.
598. HAY, GEORGE UPHAM—Note on the Botany of St. John River. *Bul. N.B. Nat. Hist. Soc.*, Jan. 1883.
599. HAY, G. U.—Notes on the Botany of New Brunswick. *Bot. Gaz.*, Nov. 1885; *Proc. Amer. Ass.* 1886.
600. HAY, G. U.—Preliminary list of New Brunswick Algae. *Bul. N.B. Nat. Hist. Soc.*, No. 5, 1886.
601. HAY, G. U.—Notes on Marine Algae of New Brunswick. *Bul. N.B. Nat. Hist. Soc.*, No. 5, 1886; No. 6, 1887; *Trans. Roy. Soc. Can.*, vol. 5, iv, p. 167.

602. HAY, G. U.—Marine Algae of the Maritime Provinces. Bul. N.B. Nat. Hist. Soc., vol. 6, pp. 62-68, 1893. Bul. Tor. Bot. Club, vol. 14, p. 220, 1887. (84 species).
603. HAY, G. U.—Report on Botany. Bul. Nat. Hist. Soc. N.B., vol. 12, pp. 69-70, 1894.
604. HAY, G. U.—The Flora of New Brunswick. Trans. Roy. Soc. Can., vol. 2, iv, pp. 45-50, 1884.
605. HAY, G. U.—Notes of a wild garden. Bul. Nat. Hist. Soc. N.B., vol. 4, pp. 108-113, 1899.
606. HAY, G. U.—A Wilderness Journey in New Brunswick. Bul. Nat. Hist. Soc. N.B., vol. 17, pp. 153-169, 1899.
607. HAY, G. U.—Preliminary list of New Brunswick Fungi. Bul. Nat. Hist. Soc. N.B., No. XIX, vol. 4, pt. 4, pp. 341-344, 1900.
608. HAY, G. U.—Annual Report of Committee on the Botany of New Brunswick. Bul. Nat. Hist. Soc. N.B., No. XIX, vol. 4, pt. 4, pp. 350-353, 1900.
609. HAY, G. U.—Observations in wild garden. Ingleside, N.B. Bul. Nat. Hist. Soc. N.B., No. XIX, vol. 4, pt. 4, p. 354, 1900.
610. HAY, G. U. & MCKAY, A. H.—Marine Algae of the Maritime Provinces with a list of species. Bul. Nat. Hist. Soc. N.B., vol. 6, pp. 62-68, 1887 (?).
611. HAY, G. U. & MACKAY, A. H.—Marine Algae of New Brunswick. With an Appendix containing a list of the marine algae of the Maritime provinces of the Dominion of Canada, with notes. Proc. Trans. Roy. Soc. Can., 1887, vol. 5, sec. 4, pp. 167-174, 1888.
612. HAYES, C. W.—An expedition through the Yukon district. Nat. Geog. Mag., vol. 4, pp. 117-162, 3 pl., 1892 (?). (Cryptogams by Miss Cummings in appendix).
613. HELLER, A. A.—Notes on Kuhnistera. Bul. Tor. Bot. Club, vol. 23, pp. 117-125, pl. 262, 1896. (Can. ref.)
614. HELLER, A. A.—New and interesting plants from Western North America. III. Bul. Tor. Bot. Club, vol. 25, pp. 580-582, 1898. (Can. ref.)
615. HELLER, A. A.—New or interesting plants from western North America. VII. Bul. Tor. Bot. Club, vol. 26, pp. 588-593, 1899. (Can. ref.)
616. HELLER, A. A.—Catalogue of the North American plants north of Mexico, exclusive of the lower cryptogams. 2nd ed., pp. 1-252. Lancaster, Pa., 1900.
617. HERVEY, A. B.—Beautiful wild flowers of America. Pls. Boston, 1881.

618. HERVEY, A. B.—Sea Mosses: A collector's Guide and an Introduction to the study of Marine Algae. Pp. 1-276, pl. 1-20, S. E. Cassino. Boston, 1881.
619. HESSELMAN, H.—Om Mykorrhizabildningar hos arktiska Växter Bihang till kgl. Svensk. Vet. Ak. Handl. Bd. 26, Afd. 3, 1900.
- 620 HILL, E. J.—Zizania is found by the explorers of the Northwest. Bul. Tor. Bot. Club, vol. 18, pp. 57-60, 1891.
621. HILL, E. J.—*Potentilla recta* L. Bul. Tor. Bot. Club, vol. 21, pp. 79-80, 1894. (*P. gracilis* Dougl. from the Sask. and Alaska to New Mexico).
622. HILL, E. J.—The Saguenay region, I-III. Gard. and For., vol. 8, pp. 182-183, 193, 213, 1895.
623. HOLM, T.—The earliest record of arctic plants. Proc. Biol. Soc. Wash., vol. 10, pp. 103-107, 1896.
624. HOLM, T—Studies in the Cyperaceae XIV. On a collection of Carices from Alaska, etc. Amer. Jour. Sc., vol. 4, x, pp. 266-284, 1900.
625. HOLZINGER, J. M.—Some Muscineae of the Northern boundary of Minnesota, collected by Conway Macmillan during 1895. Minn. Bot. Stud., vol. 1, pp. 580-582, 1896.
626. HOLZINGER, J. M.—Some Musci of the International Boundary. Minn. Bot. Stud., vol. 2, pp. 36-52, 1898.
627. HOOKER, SIR JOSEPH DALTON—The distribution of the North American Flora. Proc. Roy. Inst., vol. 8, p. 568, 1879; Ann. Sc. Nat., vol. 6, p. 318, 1878.
628. HOOKER, J. D.—Die Verbreitung der nordamerikanischen Flora. P. 22. Berlin, 1880.
629. HOUKA, J.—Les chênes de l'Amérique Septentrionale en Belgique. P. 326. Hasset, 1887.
630. HOW, H.—Additions to the list of Nova Scotian plants. Proc. Trans. N.S. Inst. Nat. Sc., vol. 4, pp. 312-321, 1877.
631. HOWE, M. A.—Gyrothyra a new genus of Hepaticae. Bul. Tor. Bot. Club, vol. 24, pp. 201-205, 1897. (Can. ref.)
632. HOWE, M. A.—The North American species of Porella. Bul. Tor. Bot. Club, vol. 24, pp. 512-527, 1897. (Some Alaskan species)
633. HOWE, M. A.—The Anthocerotaceae of North America. Bul. Tor. Bot. Club, vol. 25, pp. 1-24, pl. 321-326, 1898. (Can. ref.)
634. HOWE, M. A.—The Hepaticae and Anthocerotes of California. Mem. Tor. Bot. Club, vol. 7, pp. 1-208, pl. 88-122, 1899. (Includes some sp. reported from Alaska).

635. HUMPHRIES, MAUD—Wild Flowers of Canada. 288 coloured plates with descriptions. Oblong, 4°. Montreal, 1894.
636. JACK, J. G.—Native Trees and shrubs about Montreal, Can. I-V. Gard. and For., vol. 7, pp. 383-384, 392, 403-404, 413, 423, 1894.
637. JAMES, THOMAS POTTS—Manual of the Mosses of North America. (Lesquereux and James.) Boston, 1884.
638. JOHNSON, LAWRENCE—A Manual of the Medical Botany of North America, 8vo, pp. 290. New York, 1884.
639. KEARNEY, T. H., Jr.—A revision of the North American species of *Calamagrostis*. Bul. U. S. Dept. Agr. (Div. Agros.), vol. 2, pp. 7-42, f. 1, 1898.
640. KEELER, H. L.—Our native trees and how to identify them. Pp. i-xxiii, 1-533, f. 1-350. New York, 1900.
641. KEMP, REV. ALEXANDER F.—The Contractility of the Spores of *Palmella hyalina*. Trans. Ottawa Field Nat. Club, p. 31, 1879-80.
642. KEMP, A. F.—Filterings from the Water Supply of the City of Ottawa. Trans. Ottawa Field Nat. Club, vol. 1, p. 39, 1882.
643. KINDBERG, NILS CONRAD—Enumeratio muscorum, qui in Groenlandia Islandia et Faeroer occurrunt (etiam in Canada). Videnskabel. Meddel. Fra. d. naturhist. Foren I, Kiobenhavn, 1887. Kiobenhavn, 1888.
644. KINDBERG, N. C.—Descriptions of new species of mosses found at Ottawa. Ottawa Nat., vol. 2, pp. 154-6, 1889.
645. KINDBERG, N. C.—Determinations and descriptions of the Mosses enumerated in contributions to Canadian bryology by John Macoun. Bul. Tor. Bot. Club, vol. 16, p. 91, 1889; vol. 17, pp. 83, 271, 1890.
646. KINDBERG, N. C.—Bidrag till kannedomen om Canadaomeradets moss flora. Öfversigt af K. V. Akad. Förhandl., n. 8. Royal Swedish Academy of Sciences, Stockholm, 1890.
647. KINDBERG, N. C.—New Canadian Mosses. Ottawa Nat., vol. 4, pp. 61-65, 1890.
648. KINDBERG, N. C.—Mosses from the Pribylov Islands, Behring Sea, collected by James M. Macoun. Ottawa Nat., vol. 5, p. 179, 1892.
649. KINDBERG, N. C.—Mosses from Behring Sea collected by Jas. M. Macoun. Ottawa Nat., vol. 5, p. 195, 1892.
650. KINDBERG, N. C.—Catalogue of Canadian Plants, Part VI, Musci, by John Macoun and N. C. Kindberg. Montreal, 1892.

651. **KINDBERG, N. C.**—Notes on Canadian Bryology. *Ottawa Nat.*, vol. 7, pp. 17-23, 1893.
652. **KINDBERG, N. C.**—The European and North American Polytrichaceae, revised. *Revue Bryologique*, n. 3, 1894.
653. **KINDBERG, N. C.**—Check-list of European and North American mosses. *Can. Rec. Sc.*, vol. 6, pp. 17-23, 72-76, 1894. (Also reprinted).
654. **KINDBERG, N. C.**—*Georgia pellucida* et les espèces alliées. *Revue Bryologique*, n. 5, 1895.
655. **KINDBERG, N. C.**—Note sur les Archidiaées et note sur les Climariacées. *Revue Bryologique*, pp. 24, 25, 1895.
656. **KINDBERG, N. C.**—New or less known species of Acrocarpous mosses from North America and Europe. *Revue Bryologique*, n. 2, 1896.
657. **KINDBERG, N. C.**—New or less known species of Pleurocarpous mosses from North America and Europe. *Revue Bryologique*, n. 6, 1896.
658. **KINDBERG, N. C.**—Note sur un Hypopterygium du Canada. *Revue Bryologique*, vol. 26 pp. 46-48, 1899.
659. **KINDBERG, N. C.**—Additions to the North American and European Bryology (Moss Flora). *Ottawa Nat.*, vol. 14, pp. 77-88, 1900. (Can. ref.).
660. **KINDBERG, N. C., & MACOUN, J.**—Contributions to the Bryology of the Dominion of Canada. *Can. Rec. Sc.*, vol. 3, pp. 158-9, 1888 (?).
661. **KJELLMAN, F. R.**—Nova Ishafvets Algflora. Die Algenflora des nördlichen Eismeeers. Vega Expeditionens Vetensk. Jakttagelser, vol. 3, pp. 1-430, pl. 31. Stockholm, 1883. (Greenland, etc.)
662. **KJELLMAN, F. R.**—The algae of the Arctic Sea. *Kongl. Sv. Vetensk.-Akad. Handl.*, vol. 20, (V), pp. 1-351, pl. 1-31, 1883.
663. **KJELLMAN, F. R.**—Aus dem Leben der Polarpflanzen. In *Nordenskjöld's Studien und Forschungen veranlasst durch meine Reise in hohen Norden*. Deutsche Ausgabe. Leipzig, 1885.
664. **KJELLMAN, F. R.**—Ueber die Beziehungen der Flora des Bering-Meereres zu der des Ochotskischen Meereres. *Bot. Sekt. Naturvet. Studentsällsk i Upsala* 1888; *Bot. Centralb.*, vol. 41, pp. 167-170, 198-9, 1890.
665. **KJELLMAN, F. R.**—Om Beringhafvets algflora. Ueber die Algenflora des Beringmeereres. *Bihang. Kongl. Svensk. Vet. Akad. Handl.*, vol. 23, (VIII), pp. 1-58, pl. 7, 1889; *Bot. Centralb.*, vol. 44, p. 150, 1890; *Jour. Roy. Mic. Soc.*, p. 74, 1891.
666. **KNOWLTON, F. H.**—List of plants collected by Chas. L. McKay at

- Nushagak, Alaska, in 1881 for the United States National Museum. Proc. U. S. Nat. Mus., vol. 8, pp. 213-221, 1885.
667. KNOWLTON, F. H.—Alaskan Plants. Bot. Gaz., vol. 11, p. 340, 1886.
668. LAMSON-SCRIBNER, F.—*Stipa Richardsonii* Link and *Stipa Richardsonii* Gray. Bul. Tor. Bot. Club, vol. 19, pp. 154-156, 1892. (Can. ref.).
669. LAMSON-SCRIBNER, F.—American grasses. Div. Agros. Bul. 7, pp. 331, Washington, 1897; Bul. 17, pp. 349, Washington, 1901.
670. LAWSON, GEORGE—Notes for a flora of Nova Scotia. Trans. N. S. Inst. Nat. Sc., vol. 1, p. 84, 1863 (?).
671. LAWSON, G.—On the flora of Canada: Synopsis of all the flowering plants and ferns observed in Canada, with habitats in detail (abstract only; the list in bound volume not printed). Trans. N. S. Inst. Nat. Sc., vol. 1, p. 75, 1863 (?).
672. LAWSON, G.—Note (additional) on *Lemania variegata* of Agardh. Trans. N. S. Inst. Nat. Sc., vol. 1, p. 35, 1863 (?).
673. LAWSON, G.—Notice of the occurrence of heather at St. Ann's Bay, Cape Breton Island. Trans. N. S. Inst. Nat. Sc., vol. 1, p. 30, 1863 (?).
674. LAWSON, G.—Botanical descriptions accompanying Mrs. Miller's drawings of "The Wild Flowers of Nova Scotia". Flowers of Nova Scotia, ser. 2 and 3. London, 1867 (?).
675. LAWSON, G.—Monograph of Ericaceae of the Dominion of Canada and adjacent parts of British America. Trans. N. S. Inst. Nat. Sc., vol. 3, p. 74, 1871 (?).
676. LAWSON, G.—On the geographical range of the species and varieties of Canadian Rubi on the continents of America, Asia and Europe, as indicating possible regions of primitive distribution. Trans. N. S. Inst. Nat. Sc., vol. 3, p. 364; Trans. Bot. Soc. Edin., vol. 12, pp. 111-113, 1876.
677. LAWSON, G.—Notes on some Nova Scotian plants; *Calluna vulgaris*, *Sarothamnus scoparius*, *Rhododendron maximum*. Trans. N. S. Inst. Nat. Sc., vol. 4, p. 167, 1877 (?).
678. LAWSON, G.—On Diatomaceous deposits in the lakes of the Halifax water works. Trans. N. S. Inst. Nat. Sc., vol. 5, p. 114, 1879 (?).
679. LAWSON, G.—On the native species of *Viola* of Nova Scotia. Trans. N. S. Inst. Nat. Sc., vol. 5, p. 115, 1879 (?).
680. LAWSON, G.—On the British American species of the genus *Viola*. Trans. Bot. Soc. Edin., vol. 14, pp. 64-66, 1883; Bot. Centralbl., 1880.

681. LAWSON, G.—Notices of new and rare plants. Proc. N.S. Inst. Nat. Sc., vol. 6, pp. 68-75, 1883, reprinted.
682. LAWSON, G.—Revision of the Canadian Ranunculaceae. Trans. Roy. Soc. Can., vol. 2, pp. 15-90, 4°, 1884.
683. LAWSON, G.—On the Northern limits of Wild Grape Vines. Trans. N. S. Inst. Nat. Sc., vol. 6, p. 101, 1885 (?).
684. LAWSON, G.—On the Canadian species of the genus *Melilotus*. Trans. N. S. Inst. Nat. Sc., vol. 6, p. 180, 1885 (?).
685. LAWSON, G.—Revision of the Canadian Equiseta. Can. Rec. Sc., vol. 3, pp. 157-158, 1888 (?).
686. LAWSON, G.—Remarks on the flora of the Northern shores of America with tabulated observations made by Mr. F. F. Paine on the seasonal development of plants at Cape Prince of Wales, Hudson Strait during 1886. Proc. Trans. Roy. Soc. Can., 1887, vol. 5, sec. iv, pp. 207-212, 1888.
687. LAWSON, G.—On the Nymphaeaceae, Part I, Structure of *Victoria regia*, Lindl.; Part II, Nomenclature of Nymphaeaceae; Part III, Synopsis of Species. Trans. Roy. Soc. Can. vol. 6, sec. iv, pp. 97-125, 1889 (?).
688. LAWSON, G.—Fern flora of Canada. Halifax, N.S., pp. 30, 1889.
689. LAWSON, G.—Notes on the flora of Nova Scotia. Part I. Trans. N. S. Inst. Sc., Session of 1890-1, pp. 84-110.
690. LAWSON, G.—On the present state of Botany in Canada. Trans. Roy. Soc. Can., vol. 9, sec. iv, p. 17, 1892.
691. LAWSON, G.—Remarks on the distinctive characters of 'the Canadian spruces—species of *Picea*. Can. Rec. Sc., vol. 7, pp. 162-175, 1896.
692. LEINHART, REV. E.—Lichens of Grinnell land (in Lieut. Greeley's account of the Franklin Bay expedition, New York, vol. 2, p. 397, 1886).
693. LESQUEREUX, L. & JAMES, T. P.—Manual of the Mosses of North America, 8°, pp. v-447, 6 pl. Boston, 1884.
694. LINDBERG, H.—Om *Pohlia pulchella* (Hedw). *P. carnea* L. och nagra med dem sammanblandade former. Acta Soc. Faun. et Fl. Fenn., vol. 16, sec. II, pp. 1-27, pl. 1899. (Can. ref.)
695. LINDSAY, ANDREW WALKER HERDMAN—Catalogue of the Flora of Nova Scotia. Proc. N. S. Inst. Nat. Sc., vol. 4, p. 184, 1877 (?).
696. LLOYD, C. G. & LLOYD, J. U.—Drugs and medicines of North America, vol. 1, 1885; Part 8, vol. 2, 1886.
697. LLOYD, F. E.—Two hitherto confused species of *Lycopodium*. Bul. Tor. Bot. Club, vol. 26, pp. 559-567, 1899. (Can. ref.)
3. LLOYD, F. E. & UNDERWOOD, L. M.—A review of the species of

- Lycopodium* of North America. *Bul. Tor. Bot. Club*, vol. 27, pp. 147-168, pl. 3, 1900. (Can. ref.).
699. LOCHHEAD, WILLIAM—Prickly Lettuce and Broad-leaved Gum Plant. *Ann. Rep. Ont. Agr. Coll.*, pp. 38-39. Guelph, 1899.
700. LOCHHEAD, W.—Celery Blight, Tumble Weed, Pigeon Weed, Asparagus Rust. *Ann. Rep. Ont. Agr. Coll.*, pp. 15-16, 1900.
701. LOPATECKI, M.—Violets of Brit. Columbia. *West Amer. Scientist*, vol. 4, p. 38, 1888 (?).
702. LOPATECKI, M.—The Willows of Brit. Columbia and Alaska. *West. Amer. Scientist*, vol. 4, pp. 64-66, 1888 (?).
703. LOPATECKI, M.—The Trees of British Columbia. *West. Amer. Scientist*, vol. 6, pp. 88-91, 1889 (?).
704. MACADAM, R. K.—North American Agarics. Part I. *Jour. Myc.*, vol. 5, pp. 58-64, 1889. (Can. ref.).
705. McCLEMENT, W. T.—Report of the Botanical Section. *Ann. Rept. Entom. Soc. Ontario*, vol. 26, p. 26, 1896.
706. MACKAY, ALEXANDER HOWARD—Contributions to a catalogue of the flora of Nova Scotia. *Trans. N.S. Inst. Nat. Sc.*, vol. 4, 1877.
707. MACKAY, A. H.—Lichens of Nova Scotia. *Trans. N. S. Inst. Nat. Sc.*, vol. 5, pp. 299-307, 1881.
708. MACKAY, A. H.—Among the Cryptogams. *Acad. Sc. Monthly*, 1883-1884.
709. MACKAY, A. H.—Among the water nymphs; a popular view of the Diatomaceae. *Halifax Herald*, 1887.
710. MACKAY, A. H.—Annual Reports of the Botanical Club of Canada, 1891-1910. *Trans. Roy. Soc. Canada*, 1892-1911.
711. MACKAY, A. H.—Phenological observations made at several stations in Eastern Canada during the year 1894. *Trans. N. S. Inst. Nat. Sc.*, vol. 9, pp. 59-63, 1894-5.
712. MACKAY, A. H.—Phenological observations, Canada, 1896. *Trans. N. S. Inst. Nat. Sc.*, vol. 9, pp. 268-274, 1896-1897.
713. MACKAY, A. H.—Calcareous Algae. *Proc. N. S. Inst. Nat. Sc.*, vol. 9, pp. 92-3, 1 Fig., 1897.
714. MACKAY, A. H.—Phenological observations in Canada. *Can. Rec. Sc.*, vol. 8, No. 2, pp. 71-84, 1899.
715. MACKAY, A. H.—Phenological observations. Canada 1899. *Trans. N. S. Inst. Nat. Sc.*, vol. 10, pp. 303-318, 1899-1900.
716. MACKAY, A. H.—Phenological observations of the Botanical club of Canada, 1900. *Trans. N. S. Inst. Nat. Sc.*, vol. 10, pp. 379-384, 1900-1.
717. MACKAY, A. H.—Phenological Observations, Nova Scotia. The time of flowering of ten plants, spring of 1900, throughout the

- province of Nova Scotia. Trans. N. S. Inst. Nat. Sc., vol. 10, pp. 385-392, 1900-1.
718. MACKAY, A. H.—Remarks on the Nova Scotian Phenochrons. Trans. N. S. Inst. Nat. Sc., vol. 10, pp. 393-398, 1900-1.
719. MACKENZIE, J. J.—A preliminary list of algae collected in the neighbourhood of Toronto. Proc. Can. Inst., vol. 3, No. 7, pp. 270-274, 1890.
720. MACMILLAN, C.—Observations on the distribution of plants along shore at Lake of the Woods. Minn. Bot. Stud., vol. 1, pp. 949-1023, pl. 70-81, 1897. (Can. ref.)
721. MACOUN, JAMES MELVILLE—List of plants collected at Lake Mistassini, Rupert River, and Rupert House, 1885. Ann. Rep. Geol. Surv. Canada, pp. 36D-44D, 1885.
722. MACOUN, J. M.—Notes on the Flora of James' Bay. Bot. Gaz., vol. 13, pp. 115-118, 1888.
723. MACOUN, J. M.—Check list of Canadian Plants. Pp. 68. Ottawa, 1889.
724. MACOUN, J. M.—List of plants collected on the Rupert and Moose Rivers, along the shores of James' Bay, and on the Islands in James' Bay during the summers of 1885 and 1887. Ann. Rep. Geol. Surv. Can., vol. 3, pp. 63J-74J, 1889.
725. MACOUN, J. M.—Notes on the Flora of Canada. Bot. Gaz., vol. 16, pp. 285-288, 1891.
726. MACOUN, J. M.—Some new Mosses from the Pribylov Islands. Ottawa Nat., vol. 5, pp. 179-180, 1892.
727. MACOUN, J. M.—Contributions from the Herbarium of the Geological Survey. Can. Rec. Sc., vol. 6, pp. 23, 76, 141, 198, 264, 318, 405, 1894.
728. MACOUN, J. M.—Contributions to Canadian Botany, Parts 1-18. Can. Rec. Sc., Montreal, 1894-1906.
729. MACOUN, J. M.—Contributions to Canadian Botany. Can. Rec. Sc., vol. 6, pp. 198-210, 264-276, 318-329, 405-415, 1895.
730. MACOUN, J. M.—Liste des plantes de la Peninsule du Labrador. Commis. Geol. du Canada. Ottawa, 1895.
731. MACOUN, J. M.—List of the plants known to occur on the coast and in the interior of the Labrador Peninsula. Ann. Rep. Geol. Surv. Canada, vol. 8, Part 1, Appendix 6. Reprint. pp. 14, 1896.
732. MACOUN, J. M.—*Sisymbrium altissimum*. Bul. Tor. Bot. Club, vol. 23, p. 152, 1896. (Can. ref.)
733. MACOUN, J. M.—Contributions to Canadian Botany. Can. Rec. Sc., vol. 6, pp. 459-469, 1896.

734. MACOUN, J. M.—Contributions to Canadian Botany, XI. *Can. Rec. Sc.*, vol. 7, pp. 463-477, 1897.
735. MACOUN, J. M.—Contributions to Canadian Botany, XII. *Ottawa Nat.*, vol. 12, pp. 161-172, 1898.
736. MACOUN, J. M.—Contributions to Canadian Botany, Part III. *Ottawa Nat.*, vol. 13, pp. 158-169, 1899.
737. MACOUN, J. M.—Notes on some Ottawa Violets. *Ottawa Nat.*, vol. 12, pp. 181-187, 1899.
738. MACOUN, J. M.—A list of the plants of the Pribylov Islands with notes on their distribution. Reprint from "The Fur Seals and Fur-Seal Islands of the North Pacific Ocean", Part III, pp. 559-587, pls. 87-94. Washington, 1899. (Includes all groups except algae.)
739. MACOUN, JOHN—Report on the Botany and Agricultural capabilities of the North-West Territories. *Rept. Can. Pac. Railway*, 1877.
740. MACOUN, JOHN—Synopsis of the flora of the valley of the St. Lawrence. *Can. Jour.*, vol. 5. Montreal, 1877.
741. MACOUN, JOHN—Catalogue of the phaenogamous and cryptogamous plants (including Lichens) of the Dominion of Canada south of the Arctic Circle. Belleville, Ont., 1878. (Includes also Mosses and Liverworts as well as vascular cryptogams.)
742. MACOUN, JOHN—List of plants collected in 1880 by Dr. Robert Bell. *Geol. and Nat. Hist. Surv. Can.* 1879-80, C. 59.
743. MACOUN, JOHN—List of plants collected by Dr. Bell around the shores of Hudson's Bay and along the Churchill and Nelson Rivers in 1877 and 1879. *Rep. Progr. Geol. Surv. Can.* 1878-9, pp. 53C-60C, 1880.
744. MACOUN, JOHN—List of plants from the Queen Charlotte Islands, collected by Dr. G. M. Dawson in 1878. *Rep. Progr. Geol. Surv. Canada* 1878-9, pp. 219B-222B, 1880.
745. MACOUN, JOHN—General remarks on the land, wood and water of the North-West Territories from the 102nd to the 115th meridian, and between the 51st and 53rd parallel of latitude. *Rept. Can. Pac. Railway*, p. 235, 1880.
746. MACOUN, JOHN—Botanical notes on the southern part of the prairie region. *Rept. Dept. of the Interior*, pp. 29-41. Canada, 1880.
747. MACOUN, JOHN—Report on the North-West Territories including the Botany of the Region. *Rept. Dept. Int.* 1880-81.
748. MACOUN, JOHN—List of plants collected on the Magdalen Islands by James Richardson. (Named by J. Macoun.) *Rept. Geol. Surv. Can.* 1879-80, pp. 12G-15G, 1881.

749. MACOUN, JOHN—List of plants collected by Dr. R. Bell in the Hudson's Bay region in 1880. Rep. Geol. Surv. Canada, 1879-80, pp. 59C-69C, 1881.
750. MACOUN, JOHN—List of plants collected by G. M. Dawson in the Northern part of British Columbia and the Peace River country in 1879. Rep. Geol. Surv. Canada, 1879-80, pp. 143B-146B, 1881.
751. MACOUN, JOHN—Report on the Botany of the Region around Lake Winnipegosis, and its capabilities. Rept. Dept. Int., 1881-2.
752. —
753. MACOUN, JOHN—Notes on Canadian Polypetalae. Trans. Roy. Soc. Can., vol. 1, sec. iv, pp. 151-156, 1883.
754. MACOUN, JOHN—Catalogue of the plants collected by Dr. Robert Bell along Michipicoten River and on the southern part of the basin of Moose River. Rep. Geol. Surv. Canada, 1880, 1881, 1882, pp. 170-280, 1883.
755. MACOUN, JOHN—Catalogue of Canadian Plants, part I, Montreal, 1883; part II, Montreal, 1884; part III, Montreal, 1886; part IV, Montreal, 1888; part V, Montreal, 1890; part VI, Montreal, 1892 (Musci); part VII, Ottawa, 1902 (Lichenes and Hepaticae).
756. MACOUN, JOHN—Edible and Poisonous Fungi. Trans. Field Nat. Club Ottawa, vol. 2, pp. 62-67, 1884.
757. MACOUN, JOHN—Notes on the distribution of Northern, Southern and Saline plants in Canada. Trans. Roy. Soc. Can., vol. 1, sec. iv, p. 45, 1884.
758. MACOUN, JOHN—Notes on the flora of the Gaspé Peninsula. Trans. Roy. Soc. Can., vol. 1, sec. iv, pp. 127-136, 1884.
759. MACOUN, JOHN—Notes on Canadian Polypetalae. Trans. Roy. Soc. Can., vol. 1, sec. iv, p. 151, 1884.
760. MACOUN, JOHN—List of plants collected on the coasts of Labrador, Hudson's Strait and Bay, by Robert Bell in 1884. Report of Progress of Geol. & Nat. Hist. Survey and Museum of Canada for 1882-4. Appendix DD, pp. 38-47. Montreal, 1885. (Includes fungi by J. B. Ellis.)
761. MACOUN, JOHN—List of plants collected in Newfoundland in 1885 by Dr. Robert Bell. Geol. Surv. Can. Ann. Rep., n.ser., vol. 1, pp. 21-25DD, 1886.
762. MACOUN, JOHN—List of plants obtained by Dr. G. M. Dawson on Vancouver's Island and adjacent coasts in 1885. Ann. Rep. Geol. Surv. Canada, vol. 1, pp. 115B-120B, 1887.
763. MACOUN, JOHN—List of mosses collected in the neighbourhood of Ottawa. Trans. Ottawa Field Nat. Club, vol. 2, pp. 364-372, 1887; Ottawa Nat., vol. 3, pp. 149-152, 1890.

764. MACOUN, JOHN—Bryological Notes. *Bul. Tor. Bot. Club*, vol. 15, pp. 185-186, 1888.
765. MACOUN, JOHN—Forests of Vancouver's Island. *Garden and Forest*, vol. 1, pp. 46-47, 1888 (?).
766. MACOUN, JOHN—The Mountain Forests of Vancouver's Island. *Garden and Forest*, vol. 2, p. 525, 1889 (?).
767. MACOUN, JOHN—Note on the Poisonous properties of the *Agaricus Rodmani*. *Ottawa Naturalist*, vol. 2, pp. 142-143, 1889.
768. MACOUN, JOHN—List of plants collected by Dr. G. M. Dawson in the Yukon District and adjacent northern portions of Brit. Columbia in 1887. *Ann. Rep. Geol. Surv. Canada*, vol. 3, pp. 215B-228B, 1889.
769. MACOUN, JOHN—Contributions to the Bryology of Canada. *Bul. Tor. Bot. Club*, vol. 16, pp. 91-98, 1889.
770. MACOUN, JOHN—List of mosses collected in the neighbourhood of Ottawa. *Ottawa Nat.*, vol. 3, pp. 149-152, 1890.
771. MACOUN, JOHN—Contributions to Canadian Bryology No. 2. *Bul. Tor. Bot. Club*, vol. 17, pp. 83-90, 1890.
772. MACOUN, JOHN—Contributions to Canadian Bryology No. 3. *Bul. Tor. Bot. Club*, vol. 17, pp. 271-280, 1890.
773. MACOUN, JOHN—Notes on the Flora of the Niagara Peninsula and shores of Lake Erie. *Jour. Proc. Hamilton Assoc.*, vol. 9, p. 78, 1893 (?).
774. MACOUN, JOHN—The Forests of Canada and their distribution with notes on the more interesting species. *Trans. Roy. Soc. Can.*, vol. 12, sec. iv, pp. 3-20, 1894.
775. MACOUN, JOHN—Contributions from the Herbarium of the Geological Survey of Canada, V, VI, VII. *Can. Rec. Sc.*, 1895. (Reprinted.)
776. MACOUN, JOHN—The Cryptogamic Flora of Ottawa. *Ottawa Nat.*, vol. 11, pp. 129-140, 1897. (Mosses.)
777. MACOUN, JOHN—Sketch of the Flora of Canada. *Brit. Assoc. Handbook of Canada*, pp. 90-102. Toronto, 1897.
778. MACOUN, JOHN—The Forests of Canada with their distribution. *Brit. Assoc. Handbook of Canada*, pp. 275-296. Toronto, 1897.
779. MACOUN, JOHN—The Cryptogamic Flora of Ottawa. *Ottawa Nat.*, vol. 11, pp. 193-204, 1898; vol. 12, pp. 25-32, 49-56, 93-100, 1898. (Liverworts and Lichens.)
780. MACOUN, JOHN—Sable Island. *Ann. Rep. Geol. Surv. Can.*, n.ser., vol. 12, pp. 212A-219A, 1899.
781. MACOUN, JOHN—List of Plants collected by Mr. J. B. Tyrrell in the Klondike Region in 1899. *Ottawa Nat.*, vol. 13, pp. 209-218, 1899.

782. MACOUN, JOHN & BURGESS, T. J. W.—Canadian Filicineae. *Trans. Roy. Soc. Can.*, vol. 2, sec. iv, pp. 163-226, 1884.
783. MACOUN, JOHN & GIBSON, J.—The rarer plants of the Province of Ontario. *Trans. Bot. Soc. Edin.*, vol. 12, pp. 300-334, 1876.
784. MACOUN, JOHN & GIBSON, J.—Synopsis of the Flora of the valley of the St. Lawrence and Great Lakes with descriptions of the rarer plants. *Can. Jour.*, vol. (II), 14, pp. 51-66, 161-176, 349-364, 429-435, 546-556. Reprint, pp. 20, 1877.
785. MACOUN, JOHN & OTHERS—Botany. *Ottawa Nat.*, vol. 6, pp. 113-118, 1892.
786. MACOUN, W. T.—List of Native Trees and Shrubs growing at the Central Experimental Farm, Ottawa, July, 1895. *Ottawa Nat.*, vol. 9, pp. 109-112, 132-139, 1895.
787. MACOUN, W. T.—November Notes from the Arboretum at the Central Experimental Farm. *Ottawa Nat.*, vol. 10, p. 149, 1896.
788. MACOUN, W. T.—List of species of Maples growing at the Central Experimental Farm, Ottawa. *Ottawa Nat.*, vol. 12, pp. 133-136, 1898.
789. MANITOBA DEPARTMENT OF AGRICULTURE—Bulletin on "Weeds", issued by Province of Manitoba in 1894. (Contains 7 species.)
790. MANITOBA DEPARTMENT OF AGRICULTURE—Bulletin on Tumbling Mustard and Hare's Ear Mustard, issued by Province of Manitoba in 1895.
791. MANITOBA DEPARTMENT OF AGRICULTURE—Our Canadian Prairies, being a description of the most notable plants of Manitoba; the chief noxious weeds and how to destroy them; the trees and wild fruits, along with Arbor Day Exercises and Poems. *Man. Course of Agr.*, 1st series. Toronto, 1895.
792. MANITOBA DEPARTMENT OF AGRICULTURE—Prairie Agriculture. *Man. Course of Agr.*, 2nd Series. Winnipeg, 1895-6. (Contains sections on grasses and weeds.)
793. MANITOBA DEPARTMENT OF AGRICULTURE—Noxious weeds of Manitoba and how to destroy them. Department of Agriculture and Immigration. Winnipeg, 1896.
794. MAXON, W. R.—A list of Pteridophyta collected in Alaska in 1900 by Mr. J. B. Flett with a description of a new *Dryopteris*. *Bul. Tor. Bot. Club*, vol. 27, pp. 637-641, 1900.
795. MAYR, H.—Die Waldungen von Nordamerika, ihre Holzarten. Pp. 448, 12 pls. Munchen, 1890.
796. MEEHAN, T.—Catalogue of plants collected in July 1883 during an excursion along the Pacific coast in Southeastern Alaska. *Proc. Acad. Nat. Sc. Phila.*, pp. 76-96, 1884.

797. MERRIAM, C. H.—Plants of the Pribylov Islands, Bering Sea., Proc. Biol. Soc. Wash., vol. 7, pp. 133-150, 1892. (Includes flowering plants, etc., down to Liverworts.)
798. MIGNAULT, LOUIS DANIEL—Insectivorous plants. Natur. Canad., 1879.
799. MIGNAULT, LOUIS DANIEL—Relations of Plants and Insects. Natur. Canad., 1880.
800. MILLS, H.—Microscopic organisms in the Buffalo water supply and in the Niagara river. Proc. Amer. Soc. Mic., pp. 165-175, Buffalo, 1882.
801. MILLSPAUGH, CHAS. F.—American Medicinal Plants. New York and Philadelphia, 1884 (?).
802. MOFFATT, J. A.—*Aphyllon uniflorum* at London, Ontario. Ottawa Nat., vol. 7, p. 99, 1893.
803. MORONG, THOMAS.—Revision of the North American species of Nuphar. Bot. Gaz., vol. 11, pp. 164-169, pl. VI, 1886.
804. MORONG, T.—Notes on North American Halorageae. Bul. Tor. Bot. Club, vol. 18, pp. 229-246, 1891. (Incl. Canadian Sp.).
805. MORONG, T.—Notes on the North American species of Eriocaulaceae. Bul. Tor. Bot. Club, vol. 18, pp. 350-362, 1891.
806. MORONG, T.—A new species of *Listera*, with notes on other orchids. Bul. Tor. Bot. Club, vol. 20, pp. 31-39, 1893. (Includes *Listera borealis* Morong at Fort Smith, Slave River, Hudson Bay Territory and *Epipactis viridiflora* Morong at Toronto.)
807. MORONG, T.—Notes upon the various species of Iridaceae and other Orders. Bul. Tor. Bot. Club, vol. 20, pp. 467-473, 1893. (Includes *Iris Hookeri* Penny as occurring in Newfoundland and along Lower St. Lawrence.)
808. MORONG, T.—A revision of North American Naiadaceae. Mem. Tor. Bot. Club, vol. 3, part 2, p. 65, pl. 55, 1893.
809. MORONG, T.—The Smilacaceae of North and Central America. Bul. Tor. Bot. Club, vol. 21, pp. 419-443, 1894. (Can. ref.)
810. MORRIS, E. L.—A revision of the species of *Plantago* commonly referred to *Plantago patagonica* Jacquin. Bul. Tor. Bot. Club, vol. 27, pp. 105-119, 1900. (Can. ref.)
811. MORRISON, J.—The Kentucky Coffee Tree. (*Gymnocladus canadensis*.) Ottawa Nat., vol. 14, pp. 118-119, 1900.
812. MOSER, J. & HAY, G. U.—A list of Mosses of New Brunswick. Nat. Hist. Soc. N.B., Bul. 16, pp. 23-31, 1898.
813. MURRAY, G. & BARTON, E. S.—A comparison of the Arctic and Antarctic marine floras. Phycological Memoirs, vol. 3, pp. 88-98, 1895.

814. NARES, SIR G. S.—Narrative of a voyage to the polar sea during 1875-76. 2 vols. London, 1878.
815. NASH, G. V.—The genus *Cenchrus* in North America. Bul. Tor. Bot. Club, vol. 22, pp. 298-302, 1895. (Can. ref.)
816. NASH, G. V.—New or noteworthy American Grasses, I. Bul. Tor. Bot. Club, vol. 22, pp. 419-424, 1895. II, Bul. Tor. Bot. Club, vol. 22, pp. 463-465, 1895. (Can. ref.)
817. Nash, G. V.—New or noteworthy American Grasses, VII, Bul. Tor. Bot. Club, vol. 24, pp. 344-350, 1897. (Newfoundland ref.)
818. NASH, G. V.—The genus *Syntherisma* in North America. Bul. Tor. Bot. Club, vol. 25, pp. 289-303, 1898. (Can. ref.)
819. NASH, G. V.—Revision of the genus *Triplasis*. Bul. Tor. Bot. Club, vol. 25, pp. 561-565, 1898. (Can. ref.)
820. NEWHALL, C. S.—The Trees of N. E. America. 8°, 1890.
821. NORTHROP, J. I.—Plant notes from Temiscouata County, Canada. Bul. Tor. Bot. Club, vol. 14, pp. 230-238, 1887.
822. NORTHROP, J. I.—Plant notes from Temiscouata County, Canada. Contr. Herb. Columbia Coll., No. 3, 1887.
823. NORTHROP, J. I. & NORTHROP ALICE B.—Plant notes from Tadoussac and Temiscouata county, Canada. Bul. Tor. Bot. Club, vol. 17, pp. 27-32, 1890.
824. NORTON, J. B. S.—North American species of *Euphorbia*, section *Tithymalus*. Rep. Missouri Bot. Gardens, pp. 60, pl. 42. St. Louis, 1899.
825. NYLANDER, W.—Enumeratio Lichenum Freti Behringii, pp. 91. Caen, 1888.
826. O'MEARA, E.—Diatoms from the Arctic Seas exhibited. Quart. Jour. Mic. Sc., n.ser., vol. 18, p. 214, 1878.
827. O'MEARA, E.—*Navicula mossiana* n.sp. O'M. exhibited. Quart. Jour. Mic. Sc., n.ser., vol. 18, p. 346, 1878. (From Discovery Bay 81° 43' N.)
828. O'MEARA, E.—Some Arctic Diatoms, amongst which *Biddulphia balaena*, which appears rather to be a *Triceratium*. Quart. Jour. Mic. Sc., n.ser., vol. 18, p. 349, 1878.
829. OSLER, WILLIAM—On Canadian Diatomaceae. Can. Nat., n. ser, vol. 5, sec. iv, p. 142, 1897.
830. OYSTER, J. H.—Catalogue of the phaenogamous and vascular cryptogamous plants of North America exclusive of Mexico. Paolo, pp. 112, 1885; 2nd ed., Paolo, pp. 125, 1888.
831. PANTON, JAMES HOYES—Weeds. Ont. Agr. Coll., Bul. 10, pp. 5, 1887.
832. PANTON, J. H.—Flora of the Queen Victoria Park, Niagara Falls. Government Publication, 1889.

833. PANTON, J. H.—Weeds of Ontario. Ont. Agr. Coll., Bul. 91, pp. 7, 1893.
834. PANTON, J. H.—Impurities in clover seed. Ont. Agr. Coll., Bul. 98, pp. 8, 1894. (Can. ref.)
835. PANTON, J. H.—(1) Plants received and identified during 1894, p. 5. (2) Raspberry anthracnose, p. 7. (3) Diseases affecting the grape, pp. 8-13. (4) Impurities in clover seed, p. 16. (5) Rept. of Committee on Economic Botany and Entomology, pp. 255-257. All in 20th An. Rep. of Ont. Agr. Coll. and Exp. Farm for 1894, Pub. 1895.
836. PARSONS, F. T.—How to know the Ferns. Pp. xiv-215, ¹illus. Toronto, 1899. (Can. ref.)
837. PATTERSON, H. N.—Checklist of North American Plants. 8°, pp. 151. Oquawka, Ill., 1887.
838. PEARSON, W. H.—List of Canadian Hepaticae. Geol. Nat. Hist. Surv. Can., pamp., pp. 31, xii pl. Montreal, 1890.
839. PECK, C. H.—New species of Fungi. Bul. Tor. Bot. Club, vol. 22, pp. 198-211, 1895. (Can. and Newfoundland ref.)
840. PECK, C. H.—New species of Fungi. Bul. Tor. Bot. Club, vol. 22, pp. 485-493, 1895. (Newfoundland ref.)
841. PECK, C. H.—New species of Fungi. Bul. Tor. Bot. Club, vol. 23, pp. 411-420, 1896. (Can. ref.)
842. PECK, C. H.—New species of Fungi. Bul. Tor. Bot. Club, vol. 24, pp. 137-147, 1897. (Can. ref.)
843. PECK, C. H.—New species of fungi. Bul. Tor. Bot. Club, vol. 25, pp. 321-328, 1898. (Can. ref.)
844. PECK, C. H.—New species of Fungi. Bul. Tor. Bot. Club, vol. 26, pp. 63-71, 1899. (Can. ref.)
845. PECK, C. H.—New species of Fungi. Bul. Tor. Bot. Club, vol. 27, pp. 14-21, 1900. (Can. ref.)
846. PENHALLOW, DAVID PEARCE—Botanic Gardens. 10th Ann. Rept. Montreal Hort. Soc., 1885.
847. PENHALLOW, D. P.—First Annual Rept. Montreal Botanic Garden. Montreal, 1885.
848. PENHALLOW, D. P.—Annual Rept. of the Montreal Botanic Garden, 1886.
849. PENHALLOW, D. P.—Relations of climate to vegetation. Can. Rec. Sc., vol. 3, pp. 107-124, 1888 (?).
850. PENHALLOW, D. P.—A Review of Canadian botany from the first Settlement of New France to the Nineteenth Century. Part I. Proc. Trans. Roy. Soc. Can., 1887, vol. 5, sec. 4, pp. 45-61, 1888.
851. PENHALLOW, D. P.—Notes on *Shepherdia canadensis*. Can. Rec. Sc., vol. 3, pp. 360-363, 1889 (?).

852. PENHALLOW, D. P.—An Ancient Blaze. *Can. Rec. Sc.*, vol. 3, p. 500, 1889 (?).
853. PENHALLOW, D. P.—The Botany of Montreal, in a Hand-book for the Royal Society of Canada, Montreal Meeting, 1891.
854. PENHALLOW, D. P.—Note on a peculiar growth in Black Walnut. *Can. Rec. Sc.*, vol. 4, p. 233, 1891 (?).
855. PENHALLOW, D. P.—Notes on the flora of St. Helen's Island, Montreal. *Can. Rec. Sc.*, vol. 4, pp. 369-372, 1891 (?).
856. PENHALLOW, D. P.—Notes on the flora of Cacouna, P.Q. *Can. Rec. Sc.*, vol. 4, p. 432, 1891 (?).
857. PENHALLOW, D. P.—A new station for *Epipactis viridiflora* (Hoffm.) Reichenb. *Bul. Tor. Bot. Club*, vol. 20, pp. 440-441, 1893. (Occurs on Mt. Royal).
858. PENHALLOW, D. P.—Note on *Cephalanthus occidentalis*. *Garden and Forest*, vol. 7, p. 419, 1894 (?).
859. PENHALLOW, D. P.—Structural variations in Canadian Coniferae. *Trans. Roy. Soc. Can.*, vol. 12, sec. iii, p. 19, 1895 (?).
860. PENHALLOW, D. P.—A review of Canadian botany from 1800 to 1895, Part II. *Proc. Trans. Roy. Soc. Can.*, 2 ser., vol. 3, sec. iv, pp. 3-56, 1897.
861. PENHALLOW, D. P.—A Manual of the more common herbaceous plants of Quebec and Ontario for use in connection with Groom's Botany. Pp. xv-209. Toronto, 1899. (Bound up with Percy Groom's Elementary Botany. London, 1903. Revised Edition.)
862. PIETERS, A. J.—The plants of Lake St. Clair. *Bulletin of Michigan Fish Commission No. 2*, pp. 12 and map. Lansing, 1894.
863. POLLARD, C. L.—The genus *Achillea* in North America. *Bul. Tor. Bot. Club*, vol. 26, pp. 365-372, 1899. (Can. ref.)
864. PORTER, T. C.—Some additions to our Eastern flora. *Bul. Tor. Bot. Club*, vol. 19, pp. 128-131, 1892. (Incl. Canad. sp.)
865. PROVANCHER, L. (ABBÉ)—Un champignon remarquable. *Naturaliste Canadien*, vol. 16, pp. 50-58, fig. 56, Oct. 1886.
866. PROVANCHER, L.—Le Phallus et la Morille. *Naturaliste Canadien*, vol. 16, pp. 115-119, Feb. 1887.
867. PROVANCHER, L.—Liste des plantes recontrés aux Iles de la Madeline. *Naturaliste Canadien*, vol. 19, p. 346, 1890.
868. REDFIELD, J. H.—*Montia fontana* L. *Bul. Tor. Bot. Club*, vol. 20, p. 410, 1893. (Mentions its occurrence near Halifax, N.S. Shediac, N.B.)
870. RENAULT F. ET CARDOT J.—Musci Americae Septentrionalis, ex operibus novissimis recensiti et methodice dispositi. *Revue*

- Bryol., vol. 19, pp. 65-96, 1892 continued; also vol. 20, pp. 1-32, 1893.
871. ROBINSON, B. L. & VON SCHRENK, H.—Notes upon the flora of Newfoundland. *Can. Rec. Sc.*, vol. 7, pp. 3-31, 1896.
872. ROELL, J.—Beiträge zur Moosflora von Nord-Amerika. *Hedwigia*, vol. 36, pp. 41-66, 1897.
873. ROTHROCK, J. T.—List of and notes upon the Lichens collected by Dr. T. Bean in Alaska and the adjacent region in 1880. *Proc. U. S. Nat. Mus.*, vol. 7, pp. 1-9, 1885.
874. ROWLEE, W. W.—North American Willows. *Bul. Tor. Bot. Club*, vol. 27, pp. 247-257, pl. 8, 1900. (Can.ref.)
875. RYDBERG, P. A.—The North American species of *Physalis* and related genera. *Mem. Tor. Bot. Club*, vol. 4, pp. 297-374, 1896.
876. RYDBERG, P. A.—Notes on *Potentilla* I. *Bul. Tor. Bot. Club*, vol. 23, pp. 244-248, 1896. (Can. ref.)
877. RYDBERG, P. A.—Notes on *Potentilla* II. *Bul. Tor. Bot. Club*, vol. 23, pp. 259-265, 1896. (Can. ref.)
878. RYDBERG, P. A.—Notes on *Potentilla* III. *Bul. Tor. Bot. Club*, vol. 23, pp. 301-306, 1896. (Can. ref.)
879. RYDBERG, P. A.—Notes on *Potentilla* IV. *Bul. Tor. Bot. Club*, vol. 23, pp. 394-399, 1896. (Can. ref.)
880. RYDBERG, P. A.—Notes on *Potentilla* V. *Bul. Tor. Bot. Club*, vol. 23, pp. 429-435, 1896. (Can. ref.)
881. RYDBERG, P. A.—Notes on two western plants. *Bul. Tor. Bot. Club*, vol. 24, pp. 90-92, 1897. (Can. ref.)
882. RYDBERG, P. A.—Rarities from Montana, II. *Bul. Tor. Bot. Club*, vol. 24, pp. 243-253, 1897. (Can. ref.)
883. RYDBERG, P. A.—Rarities from Montana III. *Bul. Tor. Bot. Club*, vol. 24, pp. 292-299, 1897. (Can. ref.)
884. RYDBERG, P. A.—*Antennaria dioica* and its North American allies. *Bul. Tor. Bot. Club*, vol. 24, pp. 299-304, 1897. (Can. ref.)
885. RYDBERG, P. A.—A Monograph of the North American Potentilleae. *Mem. Dept. Bot. Columbia Univ.*, vol. 2, pp. 1-221, pl. 1-112, 1898.
886. RYDBERG, P. A.—The cespitose willows of Arctic America and the Rocky Mountains. *Bul. N.Y. Bot. Gard.*, vol. 1, pp. 257-278, Apr. 13, 1899.
887. RYDBERG, P. A.—*Delphinium Carolinianum* and related species. *Bul. Tor. Bot. Club*, vol. 26, pp. 582-587, 1899. (Can. ref.)
888. RYDBERG, P. A.—An annotated catalogue of the flora of Montana and the Yellowstone Park. Pp. ix-492 with map. New York Botanical Garden, 1900.

889. RYDBERG, P. A.—Studies on the Rocky Mountain Flora, I. *Bul. Tor. Bot. Club*, vol. 27, pp. 169-189, 1900. (Can. ref.)
890. RYDBERG, P. A.—Rocky Mountain Flora, II. *Bul. Tor. Bot. Club*, vol. 27, pp. 528-538, 1900. (Can. ref.)
891. RYDBERG, P. A.—Rocky Mountain Flora, III. *Bul. Tor. Bot. Club*, vol. 27, pp. 614-636, 1900. (Can. ref.)
892. SACCARDO, P. A.—Fungi Boreali-Americana. *Michelia*, vol. 2, pp. 564-582, Dec. 1882.
893. SAINT-CYR, D. N.—List of plants gathered by D. N. Saint-Cyr on the North Shore from St. Paul's Bay to Ouatchechou, and in the islands of Mingan, Anticosti and Grand Mecatina, during the summer of 1882 and the month of July 1885, during the leisure hours of his two trips to the Lower St. Lawrence and the Gulf. Return (17B) to an address of the Legislative Assembly. Appendix V, pp. 94-114. Quebec, 1887. (Includes all groups except Fungi and Lichens.)
894. SAINT-CYR, D. N.—Catalogue of plants in the museum of the Department of Public Instruction, gathered by D. N. St. Cyr up to 1885 or acquired by exchange or purchase. Return (17B) to an address of the Legislative Assembly, Appendix VI, pp. 115-212. Quebec, 1887. (Includes Phanerogams, Ferns, Mosses, and Seaweeds.)
895. SALMON, E. S.—The Erysiphaceae of Japan. *Bul. Tor. Bot. Club*, vol. 27, pp. 437-450, 1 pl., 1900. (Can. ref.)
896. SALMON, E. S.—A monograph of the Erysiphaceae. *Mem. Tor. Bot. Club*, vol. 9, pp. 1-292, pl. 1-9, 1900.
897. SARGENT, C. S.—A catalogue of the forest trees of North America. 93 pp. Wash., 1880.
898. SARGENT, C. S.—Report on the forests of North America. 612 pp., atlas, 16 maps. Wash., 1884.
899. SARGENT, C. S.—Silva of North America exclusive of Mexico. 12 vols, illus. Boston, 1892-98.
900. SARGENT, C. S.—North American Thorns. *Gard. and For.*, vol. 7, p. 292, fig. 49, 1894.
901. SARGENT, C. S.—The Forests of Alaska. *Gard. and For.*, vol. 10, p. 379, 1897.
902. SAUNDERS, DE ALTON—Four siphonous Algae of the Pacific coast. *Bul. Tor. Bot. Club*, vol. 26, pp. 1-4, 1899. (Can. ref.)
903. SAUNDERS, W.—Ornamental trees and shrubs that have proven hardy at Ottawa, Canada. 11 pp. 40th annual meeting West N. Y. Hort. Soc. Rochester, 1895.
904. SAUNDERS, W. & MACOUN, W. T.—Catalogue of the trees and shrubs in the arboretum and botanic garden at the Central

- mander Islands. Proc. U.S. Nat. Mus., vol. 7, pp. 529-538, 1885.
937. STEPHANI, F.—Hepaticae von der Halbinsel Alaska gesammelt 1881, 1882, von den Doctoren Arthur und Aurel Krause. Bot. Jahrb., 8, pp. 96-99, pl. 3, f. 9-11, 1887.
938. STEPHANI, F.—Species Hepaticarum. Bul. Mém. and Compl. au Bul. Herb. Boissier, 5 vols., 1898-1914. (Alaska ref.)
939. STIRTON, J.—On Lichens from Newfoundland, collected by Mr. A. Gray with a list of the species. Trans. Bot. Soc. Edin., vol. 14, pp. 355-359, 1883.
940. STUNTZ, S. C.—A revision of the North American species of the genus *Eleutera* (Beauv.) (*Neckera* Hedw.). Bul. Tor. Bot. Club, vol. 27, pp. 202-211, 1900. (Can. ref.)
941. THOMPSON, C. H.—North American Lemnaceae. Ann. Rep. Mo. Bot. Gard., vol. 9, pp. 1-22, pl. 1-4, 1897.
942. THUEMEN, VON FELIX—Contributions à la flore mycologique de la province de Quebec. Naturaliste Canadien, vol. 10, pp. 8-10, Ja., 1878.
943. TILDEN, JOSEPHINE E.—A contribution to the Bibliography of American Algae. Minn. Bot. Studies, vol. 1, pp. 295-421, 1895.
944. TRAILL, MRS. C. P.—Studies of Plant Life in Canada, or gleanings from forest, lake and plain. Coloured plates. Ottawa, 1885. New edition. Toronto, 1906.
945. TRELEASE, W.—A revision of the American species of *Epilobium* occurring North of Mexico. Second Ann. Rep. Mo. Bot. Gard., pp. 69-117, pl. 1-48, 1891. (Can. ref.)
946. TRELEASE, W.—A revision of the American species of *Rumex* occurring north of Mexico. Third Ann. Rep. Mo. Bot. Gard., pp. 74-98, pl. 13-33, 1892. (Can. ref.)
947. TUCKERMAN, EDWARD—A synopsis of North American Lichens. Part I. Boston, Mass., 1882.
948. TUCKERMAN, E.—A synopsis of the North American Lichens. Part II, 8°, pp. 176. New Bedford, 1888. (Compiled by Mr. Henry Willey.)
949. TURNER, L. M.—Contributions to the natural history of Alaska. Pp. 226, 10 pls. Washington, 1886.
950. UNDERWOOD, L. M.—Preliminary comparison of the Hepatic flora of boreal and sub-boreal regions. Bot. Gaz., vol. 17, pp. 305-312, 1892.
951. UNDERWOOD, L. M.—The Hepaticae of Labrador. Bul. Tor. Bot. Club, vol. 19, pp. 269-270, 1892.
952. UNDERWOOD, L. M.—Systematic botany of North America. Hepaticae, vol. 9, part I, p. 7, 1895.

953. UNDERWOOD, L. M.—The genus *Cephalozia* in North America. Bul. Tor. Bot. Club, vol. 23, pp. 381-394, 1896. (Can. ref.)
954. UNDERWOOD, L. M.—A preliminary list of Pacific coast Hepaticae. Zoe, vol. 1, pp. 361-367, 1897 (?). (Alaska ref.)
955. UNDERWOOD, L. M.—*Selaginella rupestris* and its allies. Bul. Tor. Bot. Club, vol. 25, pp. 125-135, 1898. (Can. ref.)
956. UNDERWOOD, L. M.—American ferns. I, The ternate species of *Botrychium*. Bul. Tor. Bot. Club, vol. 25, pp. 521-541, 1898. (Can. ref.)
957. UNDERWOOD, L. M. & SPRUCE, RICHARD—A new North American *Lejeunea*. Bul. Tor. Bot. Club, vol. 17, pp. 258-259, 1890. (From B.C.)
958. VAIL, ANNA M.—A preliminary list of the species of the Genus *Meibomia* Heist. occurring in the U.S. and British America. Bul. Tor. Bot. Club, vol. 19, pp. 107-118, 1892.
959. VAIL, A. M.—A study of the genus *Psoralea* in America. Bul. Tor. Bot. Club, vol. 21, pp. 91-119, 1894.
960. VAIL, A. M.—Studies in the *Asclepiadaceae* II. Bul. Tor. Bot. Club, vol. 25, pp. 30-39, 1898. (Can. ref.)
961. VARIOUS AUTHORS—The wild flowers of Canada. Montreal Star Office. Montreal, 1893. 308 col. plates and descriptions.
962. VASEY, GEO.—Medicinal Plants. Rep. Comm. Agric., pp. 63-75, 16 pl., 1885.
963. VASEY, G.—List of the plants collected in Alaska 1888, U.S. Fish Com. Str. Albatross. Proc. Nat. Mus., vol. 12, pp. 217-218, 1889.
964. VASEY, G.—Monograph of the grasses of the U.S. and Br. America. Contr. U. S. Nat. Herb., vol. 2, part I, pp. xiv-89, Washington, 1892.
965. VASEY, G.—Grasses of the Pacific slope including Alaska and the adjacent islands, part II. U.S. Dept. of Agr., Div. of Botany, Bul. No. 13, pp. 50, 1893 (?).
966. VORCE, C. M.—Forms observed in water of Lake Erie. Proc. Amer. Soc. Mic., pp. 51-60, pl. 7, 1881; pp. 187-196, 1 pl., 1882. (Algae.)
967. VROOM, J.—Does our Indigenous Flora give evidence of a recent change of climate? Bul. Nat. Hist. Soc. N.B., vol. 7, pp. 72-74, 1893 (?).
968. VROOM, J. & OTHERS—List of flowering plants and ferns found in Charlotte County, New Brunswick. Pp. 12. St. Stephen, 1887.
969. WAGHORNE, REV. ARTHUR CHARLES—A summary account of the wild berries and other edible fruits of Newfoundland and Labrador. Pp. 11, St. Johns, 1888.

970. WAGHORNE, A. C.—The wild berries and fruits of Newfoundland and Labrador. St. Johns Telegram, 1891.
971. WAGHORNE, A. C.—Some results of a year's work. Evening Herald, St. Johns, Newfoundland, June 15, 1892. (Contains plant notices.)
972. WAGHORNE, A. C.—Flora of Newfoundland, Labrador and St. Pierre et Miquelon. Trans. N. S. Inst. Sc., ser. 2, vol. 1, pp. 359-375, 1893; vol. 2, pp. 17-34, 1895; vol. 2, pp. 361-401, 1898. (Includes Polypetalae and Gamopetalae.)
973. WARNSTORF, C.—Beiträge zur Kenntniss exotischer Sphagna. Hedwigia, pp. 1-17, 1893. (Refers to Canadian species.)
974. WATSON, S.—Bibliographical index to North American botany. 474 pp. Washington, 1878. No. 258 Smith. Misc. Coll. XV.
975. WATSON, S.—Revision of the North American Liliaceae. Proc. Amer. Acad. Arts Sc., vol. 14, pp. 213-288, 1879. (Can. ref.)
976. WATSON, S.—Descriptions of some new species of North American plants. Proc. Amer. Acad. Arts Sc., vol. 14, pp. 288-303, 1879. (Can. ref.)
977. WATSON, S.—Notes on the flora of the Upper Yukon. Science, vol. 3, pp. 252-253, 1884.
978. WATSON, S.—Descriptions of some new species of plants. Proc. Amer. Acad. Arts Sc., vol. 22, pp. 466-481, 1887. (Can. ref.)
979. WATSON, S.—Some new species of plants of the United States with revisions of *Lesquerella* (*Vesicaria*) and of the North American species of *Draba*. Proc. Amer. Acad. Arts Sc., vol. 23, pp. 249-267, 1888. (Can. ref.)
980. WATSON, S.—Descriptions of some new species of plants, chiefly Californian with miscellaneous notes. Proc. Amer. Acad. Arts Sc., vol. 24, pp. 82-87, 1889. (Can. ref.)
981. WATSON, S.—Contributions to American Botany, XVIII. Proc. Amer. Acad. Arts Sc., vol. 26, pp. 124-163, 1891 (?) (Includes sp. of B.C.)
982. WEATHERILL, H. E.—List of plants obtained on the Peary Auxiliary Expedition of 1894. Bul. Geogr. Club Phila., vol. 5. Reprint, pp. 10, 1895 (?).
983. WETTSTEIN, R. V.—Monographie der Gattung *Euphrasia*. Leipzig, 1896. (Can. ref.)
984. WHELLOCK, W. E.—A descriptive list of species of the genus *Heuchera*. Bul. Tor. Bot. Club, vol. 17, pp. 191-204, 1890.
985. WHELLOCK, W. E.—The genus *Polygala* in North America. Mem. Tor. Bot. Club, vol. 2, No. 4, pp. 109-152, 1892 (?).
986. WHELLOCK, W. E.—A list of species of the smaller herbaceous

- genera of North American Saxifragaceae. Bul. Tor. Bot. Club, vol. 23, pp. 67-78, 1896. (Can. ref.).
987. WHITE, T. G.—A preliminary revision of the genus *Lathyrus* in North and Central America. Bul. Tor. Bot. Club, vol. 21, pp. 444-458, 1894. (*Lathyrus Nuttallii* S. Wats., in B.C.).
988. WHEYTE, R. B.—A Botanical excursion to "The Chats". Ottawa Nat., vol. 5, p. 197, 1892.
989. WHEYTE, R. B.—Report of the Botanical Branch, 1893. Ottawa Nat., vol. 8, pp. 38-41, 1894.
990. WIEGAND, K. M.—*Galium trifidum* and its North American allies. Bul. Tor. Bot. Club, vol. 24, pp. 389-403, 1897. (Can. ref.).
991. WIEGAND, K. M.—A revision of the genus *Listera*. Bul. Tor. Bot. Club, vol. 26, pp. 157-171, 1899. (Can. ref.)
992. WIEGAND, K. M.—Some species of *Bidens* found in the United States and Canada. Bul. Tor. Bot. Club, vol. 26, pp. 399-422, 1899.
993. WIEGAND, K. M.—Some notes on *Saxifraga* and *Primula*. Bul. Tor. Bot. Club, vol. 27, pp. 388-391, 1900. (Can. ref.)
994. WIEGAND, K. M.—*Juncus tenuis* Willd. and some of its North American allies. Bul. Tor. Bot. Club, vol. 27, pp. 511-527, 1900. (Can. ref.)
995. WILLIAMS, R. S.—Botanical notes on the way to Dawson, Alaska. Plant World, vol. 2, pp. 177-181, 1899.
996. WILLIAMS, R. S.—Forest conditions in the Klondike. Jour. N. Y. Bot. Gard., vol. 1, pp. 44-46, 1900.
997. WINN, A. F.—White variety of the fire-weed. Can. Rec. Sc., vol. 5, p. 300, 1892.
998. WOLLE, F.—Diatomaceae of North America. pp. i-xiii, 15-47, pl. 1-112, Bethlehem, 1890. also Amer. Nat., vol. 25, pp. 484-485, 1891.

(To be continued)

