

GOVERNMENT OF INDIA

DEPARTMENT OF ARCHAEOLOGY

CENTRAL ARCHÆOLOGICAL  
LIBRARY

CALL NO.

913.38005/A.B.S.A.

ACC. NO.

31809

D.G.A. 79.

GIPN—S4—2D. G. Arch. N. D./57.—25-9-58—1,00,000.

A9.  
P. 2  
17.8.16



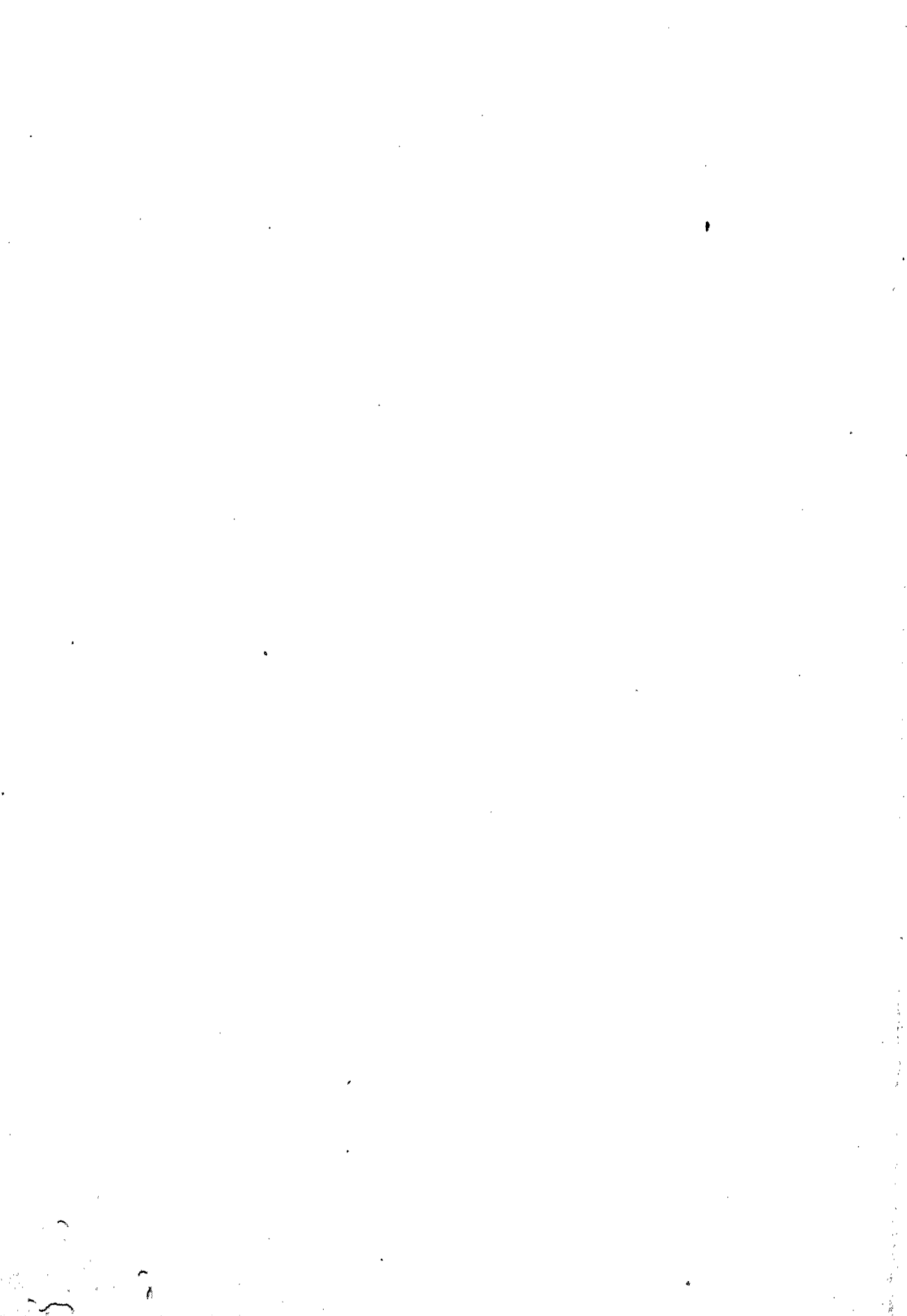



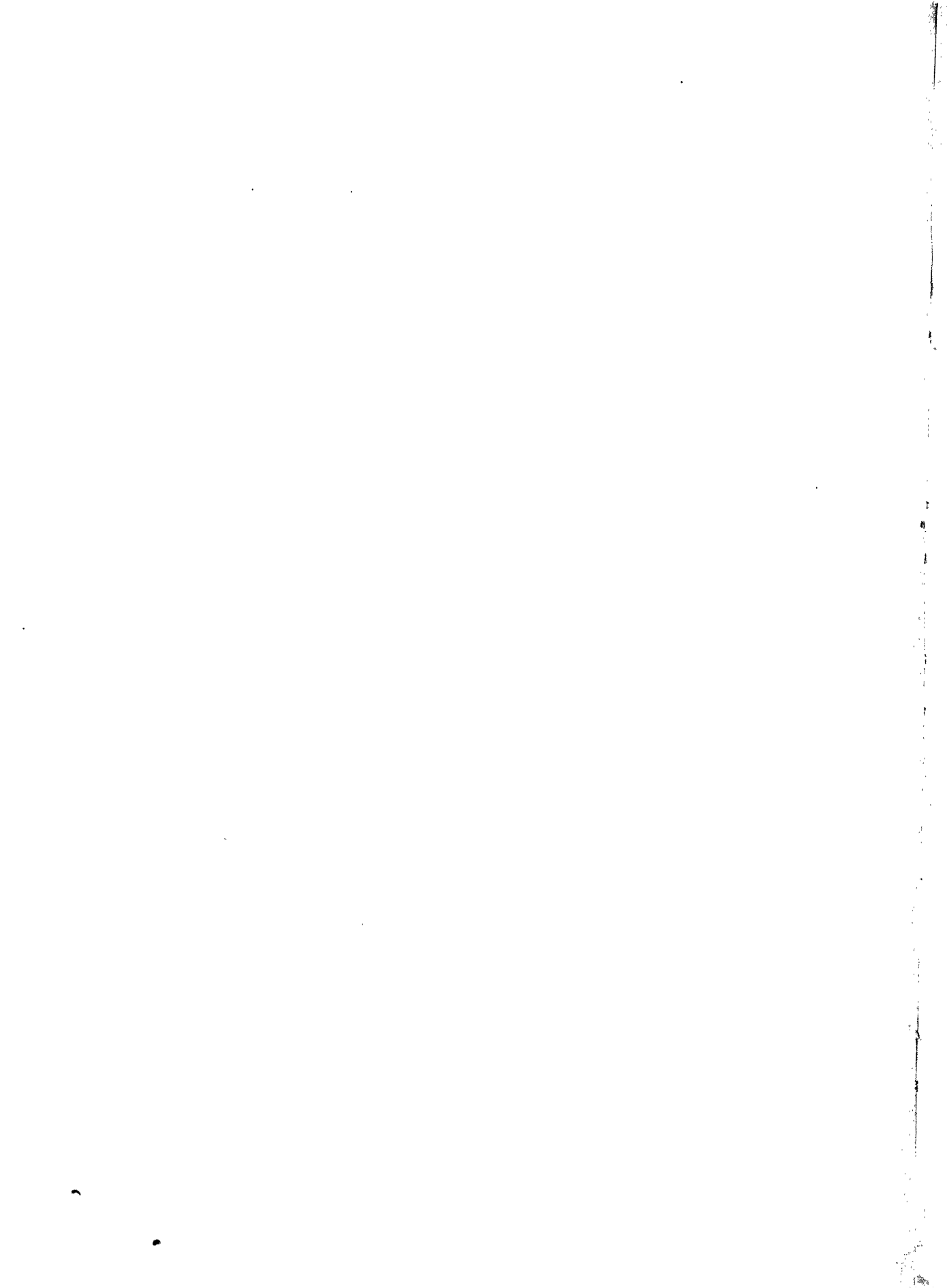

THE ANNUAL  
OF THE  
BRITISH SCHOOL AT ATHENS

No. XX.

22920

913.38005

A. B. S. A.

SESSION 1913-1914

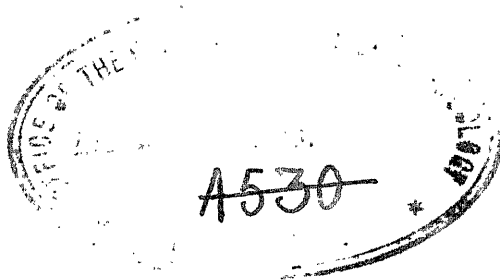

PRINTED FOR THE SUBSCRIBERS AND SOLD ON THEIR BEHALF BY  
MACMILLAN & CO., LIMITED  
LONDON

# THE BRITISH SCHOOL AT ATHENS

PATRON.—HIS MAJESTY THE KING.

## MANAGING COMMITTEE, 1913—1914.

EDWIN FRESHFIELD, ESQ., LL.D.

WALTER LEAF, ESQ., Litt.D.

GEORGE A. MACMILLAN, ESQ., D.Litt., *Chairman.*

} *Trustees.*

PROFESSOR PERCY GARDNER, Litt.D. Appointed by the University of Oxford.

SIR JOHN SANDYS, Litt.D. Appointed by the University of Cambridge.

MISS JANE E. HARRISON, D.Litt., LL.D. Appointed by the Hellenic Society.

MISS C. A. HUTTON, *ex officio* as joint Editor of the *Annual.*

PROFESSOR R. C. BOSANQUET, M.A.

SIR ARTHUR J. EVANS, D.Litt., LL.D.

THEODORE FYFE, ESQ., F.R.I.B.A.

PROFESSOR ERNEST GARDNER, Litt.D.

D. G. HOGARTH, ESQ., M.A.

PROFESSOR J. LYNTON MYRES, M.A.

SIR CECIL HARCOURT-SMITH, LL.D.

M. N. TOD, ESQ., M.A.

A. J. B. WACE, ESQ., M.A.

SIR CHARLES WALDSTEIN, Litt.D.

L. WHIBLEY, ESQ., M.A.

A. E. ZIMMERN, ESQ., M.A.

} Appointed by the Subscribers.

V. W. YORKE, ESQ., M.A., *Hon. Treasurer*, Farringdon Works, Shoe Lane, E.C.

JOHN ff. BAKER-PENOYRE, ESQ., M.A., *Secretary*, 19, Bloomsbury Square, W.C.

## DIRECTOR, 1913—1914.

R. M. DAWKINS, ESQ., M.A., Fellow of Emmanuel College, Cambridge.

*Assistant Director and Librarian* :—F. W. HASLUCK, ESQ., M.A., Late Fellow of King's College, Cambridge.

**CENTRAL ARCHAEOLOGICAL  
LIBRARY, NEW DELHI.**

Acc. No. .... 31.00.9

Date ..... 1.8.1914

Call No. .... 913.3800

A-B-S.A.

## TABLE OF CONTENTS.

		PAGE
1.	R. M. DAWKINS.      Excavations at Pláti in Lasithi, Crete. (Plates I.-VII.) . . . . .	1
2.	C. A. SCUTT.      The 'Tsakonian Dialect.—II. . . . .	18
3.	W. R. PATON.      } Modern Greek Carols in Honour of Saint	
	W. R. HALLIDAY.    } Basil . . . . .	32
	W. R. HALLIDAY.    Note on the Fragments of the Gypsy Carol . . . . .	57
4.	F. W. HASLUCK.      Thevet's <i>Grand Insulaire</i> and his Travels in the Levant. (Plate VIII.) . . . . .	59
5.	”      ”      Dieudonné de Gozon and the Dragon of Rhodes. (Plate IX.) . . . . .	70
6.	”      ”      The 'Tomb of S. Polycarp' and the Topography of Ancient Smyrna. (Plates X, XI.) . . . . .	80
7.	”      ”      Ambiguous Sanctuaries and Bektashi Propaganda . . . . .	94
	Note on Haidar, Khodja Achmet, Karadja Achmet . . . . .	120
8.	A. J. B. WACE.      The Mounds of Macedonia . . . . .	123
-----		
	Annual Meeting of Subscribers . . . . .	133
	Income and Expenditure, 1913-1914 . . . . .	147
	Donations and Subscriptions, 1913-1914 . . . . .	149



	PAGE
List of Subscribers . . . . .	154
List of Directors, Honorary Students, Students and Associates . . . . .	159
Suggested Plan of Study . . . . .	168
Rules and Regulations of the British School at Athens . . . . .	169
Notice to Contributors . . . . .	172
Index . . . . .	179

## LIST OF PLATES.

---

- I. Excavations at Pláti: Plan of the Site.
- II. Excavations at Pláti: Late Minoan I. Vase.
- III. Excavations at Pláti: Block **A**.—*a*, Frontage on Central Court with Entrance Portico. *b*, Pithos from **A 9**. *c*, Rooms **A 4, 5, 6, 7**; behind them early Road; in Foreground, Angle of Wall in Front of **A 6**. Block **B**.—*d*, Paved Court (**B 1, 2**); Middle Distance, Epáno Kepháli; Horizon, the Peak of Aféñdi Sarakinós.
- IV. Excavations at Pláti: Block **A**.—*a*, Entrance Corridor (**A 10**) and Inner Courts (**A 11, 12**) beyond; on the Left, Back of Western Portico (**A 19, 20**). *b*, Inner Courts (**A 11, 12**) shewing two Steps between; Peak of Dikté in the Background. *c*, Front Room (**A 13**) of Eastern Portico; Middle Distance, Village of Gerodomouri. *d*, Western Portico (L.); Entrance Corridor (R.).
- V. Excavations at Pláti: Greek Objects.—*a*, Bronze Relief of a Dancer. *b, c*, Fragments of Stamped Pithoi. *d*, *Ibid.* from Gemboros.
- VI. Beehive Tomb near Pláti: Plan and Section.
- VII. 1. Beehive Tomb near Pláti: Clay Larnax.  
2. Palaikastro: Clay Larnax with sunk Panels.
- VIII. Thevet's *Grand Insulaire*: View of Athens after the *Cosmographie Universelle*.
- IX. Dieudonné de Gozon: The *Turasque* of Tarascon.
- X. The Tomb of S. Polycarp: 1. View of the Tomb. 2. Plan of Smyrna, after Storari. 3. Plan of the 'Judicatorium' after Drummond's *Travels*.
- XI. The Tomb of S. Polycarp: View of Smyrna, after Le Bruyn's *Voyage*.



# EXCAVATIONS AT PLATI IN LASITHI, CRETE.

(PLATES I.—VII.)

---

## § 1.—*Introductory.*

WHEN I was at Candia in the autumn of 1913, Dr. Hatzidakis, the Ephor of Antiquities, told me that a report had reached him of a Minoan site near the village of Pláti in the plain of Lasithi, and suggested that the School should apply for a permit to excavate it. Before leaving Crete I made a preliminary inspection of the site, and the prospects seemed to justify the School in undertaking the work. The local account was that a woman had had a dream that by digging in a certain place a church bell would be found. The villagers accordingly dug a hole in the place indicated, and found not a bell but an early piece of wall and some fragments of obsidian. A report of the discovery was made to the authorities by the scholarch of Tsermiádo, the chief village of Lasithi, and it was this document to which Dr. Hatzidakis called my attention.

The usual kindness of the Cretan authorities produced the required permit, and by the 25th of April the site had been measured by the government engineer in accordance with the law now in force, and we were able to begin the work. This lasted for exactly a month, until the 25th of May, the number of men employed being for the most part about thirty, and resulted in the discovery of the Minoan settlement described in the second section of this report. The party consisted of Messrs. J. P. Droop, R. M. Heath, and M. L. W. Laistner with the Director in charge throughout. Messrs. Boxwell and Scutt were present for a part of the time only. As foreman we had Ioannis Katsarakis, who has served the School as mender from the time when he first entered our employ at Palaikastro. The photography was undertaken by Mr. Droop, and the plan was drawn

in London by Mr. W. S. George from the measurements and notes of Mr. Heath. The excavation was officially visited by the Ephor of Antiquities, Dr. Stephanos Xanthoudides, whose support and help the School gladly acknowledges. At the close of the excavation the finds were removed to the Museum at Candia, the arrangements of which remain, and it is hoped will remain, the same under the new as they were under the old régime in Crete. The present report deals with the excavation itself; the finds will form the subject of a paper in a later volume of the *Annual*. A few examples only of the stamped pithoi are shown on Pl. V, *b, c, d*, and with them (Pl. V, *a*) a fragment of bronze with a small figure of a draped dancing figure in relief, which is the latest object found on the site. It was found quite close to the surface.

The general configuration of the Lasithi plain is well known from Spratt's description and Mr. Hogarth's report of his excavation of the Psykhró cave.<sup>1</sup> Immediately to the north of the double peak of Dikte are two elevated plains shut in on all sides by the northern spurs of the mountain. The basin to the east is known as Katharó, that to the west is the plain of Lasithi. Katharó is smaller, higher, and not so level as Lasithi; as far as I am aware no ancient remains have been found in it. The elevation is so considerable that the climate is too severe for continuous habitation, and it contains only a group of little houses and dairies used by the inhabitants of Kritsá who come up in the summer for ploughing and harvesting and to graze their flocks. It is drained by a river which escapes through a deep and narrow gorge on the western side and so enters the lower and larger plain of Lasithi.<sup>2</sup> The chief difference between the two plains depends on the fact that Katharó is drained by a river with an open channel, and that in consequence water never stands in it, and the ground is broken up by the unevennesses caused by the natural flow of the surface water, whilst Lasithi is entirely surrounded by hills, its only outlet being an underground channel through which the river escapes at the western, or as the natives always say, the lower end of the plain, near the foot of the pass from Lyttos. At this point the river which, after descending through the gorge from Katharó, winds along the northern side of the plain, disappears into a funnel-shaped

<sup>1</sup> *Travels and Researches in Crete*, i, pp. 100 sqq; *B.S.A.* vi, pp. 94 sqq.

<sup>2</sup> The Katharó plain has been described by Miss Bate, in the *Geological Magazine*, Decade V, vol. ii, pp. 199 sqq.

pit close below an overhanging wall of rock. This *katavothra*<sup>1</sup> is, at least at present, not sufficiently large to drain the plain rapidly and in consequence of this the winter and spring rains gather in the plain and turn it for a time into a lake, the waters of which only slowly subside, sometimes so tardily that the crops are entirely spoiled. This disaster occurs only rarely, but the fact that the water regularly stands for some time in the basin makes it drop its suspended earth instead of carrying it off as an unimpeded mountain torrent would do, and this in the course of ages has filled the basin with a flat expanse of alluvial soil, now several metres deep, up to the level of the drainage hole, and by now considerably above it.

With such a natural formation the villages of Lasithi must necessarily have always been where they are now, out of the reach of the floods on the skirts of the ring of hills which surround the plain, the only building in which is the little church of Hagios Georgios. Lasithi is larger and the villages more numerous than appears at first sight, for one of the foot-hills stretches out so far and rises so high at the end as almost to divide the plain into two parts. This is the promontory crowned with a little chapel, which runs out from the south to the east of Psykhró, and it conceals an eastern region, the upper part of Lasithi, which contains several villages, Mesa (Inner) Lasithi, Hagios Constantinos, and some other smaller places. These are only connected with the main or lower part of Lasithi by a narrow waist of plain, made still narrower by the stony knoll on which stands the Monastery of Panagía Krystallénia. The river flows by the foot of the monastery hill. The height of the promontory which separates it from the western part of the plain effectively conceals this eastern region, the very existence of which would hardly be suspected by the traveller approaching Lasithi in the usual way from Candia and Lyttos.

The exact sites of the villages round the plain depend on two considerations; the chief is that there must be a good spring, and the second is that they should be near the end of one of the mountain paths which connect Lasithi with the outer world. Incidentally this generally means that they are near the mouth of one of the side valleys, the slopes of which are very suitable for vineyards. Thus Tsermiádo, the

<sup>1</sup> *Katavothra* is the word used on the Greek mainland. The Cretans say *χάσμος*, *funnel*.

administrative centre of Lasithi, is at the beginning of the path south-west to Avdoú, Mesa Lasithi of the path to Potamiés and Neapolis, and Kamináki of the path to Viáno on the southern coast. Of these well recognised ways out of Lasithi there are at least five. The best known is the road to Lyttos, which starts from the *katavothra* and goes over the *col* known as the Tomb of Tsoúrli,<sup>1</sup> but there is also a path to Kritsá, which passes through the plain of Katharó, and the already mentioned roads to Avdoú, Viáno, and Neapolis. It is also possible to go over a *col* to the south-east to Málles and Kalamáfka, and so to Hierapetra.

A search for Minoan sites on the edges of the plain is very speedily rewarded. There is one near Kamináki, another at Marmakéto on the northern side, and probably several others. The site which was chosen for our excavation lies on the southern side of the plain, a quarter of an hour to the west of Psykhró. The road from Lyttos, after passing the mouth of the *katavothra* and the little hamlet of Metókki, skirts the foot of a considerable promontory, which juts out into the plain. On this is the village of Gerodomourí. When this has been passed Psykhró comes into sight, but before reaching it the road leaves on the right two rocky knolls which run down from the hills. These are the Epáno and the Káto Kepháli of the village of Pláti, which lies a few minutes off at the foot of the eastern slope of the side valley below the peak known as Aféndi Sarakinós (Pl. III, *d*). On these two knolls are the Minoan remains, and the cemetery of the town seems to have lain in the lower part of the Aféndi Sarakinós valley. The western of the two knolls is the higher, and is therefore called the Epáno Kepháli. The top of it is now occupied by the village cemetery and mortuary chapel. The western slope of it is very steep and rocky, but on the eastern slope which faces towards the lower knoll there are numerous remains of Minoan walls. The houses, however, have been so much destroyed by terracing and denudation that it is not likely that excavation would yield much; the sherds found at the foot of the slope were all Late Minoan III. The peasants say that a find of bronze

<sup>1</sup> The local legend of the Tomb of Tsoúrli (τὸ μνήμα τοῦ Τσοῦρλη) is that Tsoúrli was a Turk who went by this path to a Christian village in Lasithi, and there insulted the women, notably by making them dance before him. On his return he was waylaid at this point by one of the men of the village and killed. His head was cut off and put into the saddlebag of his mule, which duly arrived at his home with the terrible burden, and his body was thrown into the cleft in the rock now known as the Tomb of Tsoúrli, and covered with a heap of stones. The place is regarded as ill-omened.

weapons was once made on this hill near the present entrance to the cemetery.

The most important remains are all to the east of this on the Káto Kepháli, separated from the Epáno Kepháli by a small hollow through which the present road passes. The surface of this hollow is covered with sherds, and it was here that our first trial-pits were made. They revealed a depth of two or more metres of soil before the rock was reached, but no walls, and the sherds were so scarce below the surface layer that it appears that they have all been washed down from the slopes of the Epáno Kepháli. The surface of the Káto Kepháli yielded very different results. The earth was not abundant, and, especially towards the edges of the rising ground, there was even a good deal of bare rock visible. But wherever there was earth, the tops of numerous walls appeared, and the owners of the fields agreed that there were more below the surface. We were also told that it was from these fields that the peasants had taken large numbers of blocks to build their houses, and, to judge from our excavations, it seems very likely that no small part of the village has been built from this quarry. Both Pláti and Psykhró are said to have been burned by the Turks in the rising of 1866, and it is probable that the ancient site has suffered very much in the rebuilding that took place after this disaster.

The site is cultivated, and the somewhat heavy price demanded for the corn was the principal item in the compensation which we had to pay. There were also a few almond trees by the thick field walls which ran across the centre of the site, but except for this the ground was quite open. Such of the field walls as were not destroyed are shewn on the plan as a guide to the exact identification of the site.<sup>1</sup> At the end of the excavation the earth was thrown back and the whole site covered up.

### § 2.—*The Minoan Houses.*

It will simplify this account to say at once that the earliest remains found were of the Late Minoan I period, that the houses of the latest and best preserved phase of the Minoan town were Late Minoan III, and that over a part of the site there was a stratum that must be dated to the

<sup>1</sup> A very rare plant is found in abundance amongst the loose stones of these walls. This is *Aristolochia microstoma* which is found nowhere outside Crete, and even there cannot, I think, be at all common.



The Minoan date of this was plain ; the layer of ashes was entirely below the Greek walls, and the sherds found amongst them were exclusively Minoan. The arrangement of the houses is very striking ; if the three blocks were separate houses with different owners, we then have an example of town planning quite different from anything found elsewhere in Crete, where the towns, to judge at least from Palaikastro and Gournia, were as a rule built with only narrow lanes between the houses ; if on the other hand the three blocks form part of a single building, the obvious comparison is with the Great Central Court of the Palace at Knossos.

Of these three blocks, **C** is the worst preserved ; little of it in fact remains but the foundations of the south wall and the plaster floor of one of the rooms (**C 3**). Between **C 1** and **C 2** the wall turns to the north, and it seems as if this was the corner of the house and the thinner wall of **C 1** a later addition. It may, however, be a continuation of the façade after one of those set-backs common in Minoan and Mycenaean buildings, of which there are examples in the façade of Block **A** between **A 3** and **A 4** and between **A 8** and **A 9**. That there is no entrance on the central court may be put down to the fact that only the foundations are preserved. The same is to be noted in Block **B**, which has in its present state no opening on the court except the very narrow gap in **B 4**.

Block **B**, although hardly more than the foundations of the walls and the thresholds remain, is at least so far preserved that the general plan can be clearly made out. The foundations rested directly upon the rock, so that there was no possibility of any earlier archaeological stratum. The fact that only the lowest course of the walls has been preserved accounts for the general absence of doorways in the plan, and if there was any considerable entrance on the central court, no trace of it remains ; the house as it stands opens towards the west on the paved court (**B 1** and **B 2**), which is shewn in the photograph in Pl. III, *d*. It is more than possible that the little gap in the wall of **B 4** is due to the later loss of a stone, and that if the walls were better preserved we should have found a wide entrance from this room on the central court. In this case the passage formed by **B 2**, **B 3**, and **B 4** would correspond on the plan to the entrance corridor (**A 10**) of Block **A**, and the paved court (**B 1** and **B 2**) to the inner court of Block **A**. In the present condition of the house, however, the only certainty is that the house had a door opening on a courtyard, and the question of its main entrance must be left undecided. It may, however,

be noted that the edge of the excavation, as it crosses the paved court, is the line of the modern lane which passes up from the plain to the village; its level is much lower than that of the house, and beyond it again is the still lower hollow between the Káto and the Epáno Kepháli. This configuration of the ground not only shews that not much of the ground-plan of the house has disappeared, but also makes it unlikely that the main entry was on this side, and so supplies a further reason for supposing that the house had originally an entrance on the central court.

The pavement of the court **B 1** and of the space **B 2** passes underneath the wall between them. This is therefore later than the pavement, although its parallelism with the rest of the plan makes it plain that it was built to form a part of the house. The most interesting point in the plan of the house is the central passage between two rows of rooms, **B 5**, **6**, and **7** on one side, and **B 8**, **9**, and **10** on the other. This is a feature also of the one well preserved house that was found on the Mycenaean site of Sparta, and, as the Spartan remains all belong to the later Mycenaean period, the two houses may well be contemporary.<sup>1</sup>

Block **A**, which contains the largest and best preserved of the houses (**A 10** to **A 23**), has a frontage, shewn in Pl. III, *a*, of 43 metres on the centre court, broken by two of the characteristic Minoan set-backs, one between **A 3** and **A 4** and the other between **A 8** and **A 9**. The eastern part of this façade (from **A 2** to **A 9**) forms the front to a row of rooms which rested on the foundations of the older Late Minoan I house. Owing to the rise of the ground towards the south and west, the greater part of the inner walls of the house have disappeared, but it seems to have run up the hill and overlaid the old Late Minoan I road ('Early Road' on the plan). At the space marked **A 6** the front wall is broken by three large slabs, in front of which there is a projecting angle of wall; it is likely that we should recognise in this the remains of the entrance of this house which must have been of some size, as it not only included all the rooms from **A 2** or **A 3** to **A 9**, but also apparently covered the early road and some part of the rising ground behind, where the Late Minoan I walls (**A 1** on the plan) and the painted vase were found. The photograph in Pl. III, *c*, illustrates this; in the background is the early road, in front of this from left to right are the rooms **A 4**, **5**, **6**, and **7**, and in the foreground are the three slabs in question and in front of them the projecting angle of

<sup>1</sup> For a description and plan of the Sparta house *v. B.S.A.* xvi, pp. 6, 7.

wall. The only find, beyond a certain amount of plain pottery, was in **A 9**, where the lower half of a pithos, shewn in Pl. III, *b*, was found *in situ*. It appears, however, from the level at which it was found, to have belonged to the earlier Late Minoan I building.

The western part of this block is formed by the finest of the houses. It consists of several distinct parts; the entrance corridor (**A 10**) leading to a double inner court (**A 11** and **A 12**), the large portico (**A 13** to **A 16**), the small portico (**A 17** to **A 20**), and the rooms behind the porticoes (**A 21**, **22**, **23**). The ground upon which it is built rises from front to back, so that, whilst there was more than two metres of earth at the entrance to the portico, at the back of the house the soil was so shallow above the rock that it was not worth while to extend the area of the excavation. The plan, however, has lost none of its essential features.

The door on the central court has a threshold 2 metres wide and 90 metre deep. On its upper surface there are two sunken holes for the pivots of a pair of doors. This doorway opens on a passage 2 metres wide and 9 metres long (**A 10**), leading to the inner court. It is paved with irregular slabs and has a deep gutter on the left to carry off the rainwater from the inner court and the roofs, for which the slope of the ground gives an ample fall. At the further end of the passage is a second threshold, again with two holes for door-pivots. This passage with the gutter on the left appears in Pl. IV, *a* and *a'*, the latter shewing also the outer threshold with its pivot-holes.

Beyond this passage is a paved space (**A 11**), measuring 5.00 metres by 3.40 metres. In front of the right-hand wall there is a narrow step, or rather plinth, and two shallow steps (Pl. IV, *b*) run across its full width and ascend to a larger paved space beyond (**A 12**). This is 7.30 metres wide, but its other dimension cannot be recovered, as at this point the shallowness of the soil has led to the destruction of the plan. On the left of the court two doorways with thresholds lead into the rooms (**A 21** and **22**) at the back of the porticoes. All this part of the house is overlaid by a later construction which has no connexion with it, and probably belongs to the Greek period.

This arrangement of a house, with an entrance passage leading to an interior court and doors at each end of the passage, is exactly the same as that of some of the modern Moslem houses in Candia, except that in these the desire for privacy causes the corridor to be set at a slight angle, so that

even when the doors at both ends of the passage are open the inner court is still screened from the eyes of persons passing along the street.

Of the two porticoes the western, shewn in Pl. IV, *d*, has a width of 3·20 metres, and is thus exactly half the width of the eastern. It consists of a series of rooms (**A 17** to **A 20**), which lead up the slope to **A 22** by a doorway, the threshold of which, with the hole for the door-pivot, has been preserved. The first of this series of rooms (**A 17**) is open to the central court and partly paved. On the front edge of the biggest of these slabs—it is 1·90 metres in length—are two holes for door-pivots, which shew that it was once used as the threshold for a doorway.<sup>1</sup> In its present position it can hardly have carried doors, as there is no wall on the left side; the builders probably took the block from an older building. In the centre of the room (**A 17**) there is an oblong block which seems to have supported a pillar, and there are narrow doorways on the right and left, the first into the entrance passage (**A 10**) and the second into the big portico (**A 13**). Beyond this entrance are three rooms (**A 18**, **19**, **20**) communicating with one another and leading up to the big door into **A 22**. The nature of the walls between these rooms is not quite clear. The upper two, those between **A 19** and **A 20**, and between **A 18** and **A 19**, have three slabs on their upper surface, and the lowest, between **A 17** and **A 18**, has two of these slabs. Between the right-hand pairs of slabs there was certainly a free passage, and in the two upper walls the thresholds are preserved. The walls to the left of these openings in no case rise above the level of the floor of the room next above, and it therefore seems likely that on the left also there were openings, and that the central slabs supported pillars, and those on the right and left formed bases for engaged *antae*. This view requires that we supply a left-hand slab in the lowest wall, that between **A 17** and **A 18**. This last piece of wall is seen in the photograph to rise considerably above the level of the slabs; in this we must recognise a later alteration in the house, and in the course of this the slab may very well have been removed. Such alterations are also to be found in the large portico. The piece of later wall which is shewn in the plan partly covering the slabs between **A 19** and **A 20** is later still, and may be put down to the Greek period; it had been removed when the photograph shewn in Pl. IV, *d*, was taken.

<sup>1</sup> These holes are shewn in the plan. Although the block itself appears very well in the middle of Pl. IV, *d*, the holes are so shallow as to be barely visible.

The eastern portico (**A 13–16**, Pls. III, *a*, and IV, *c*, *d*) is on a much larger scale. Its opening on the central court is 6·20 metres wide and is divided into two bays by a central block of limestone which measures 75 m. in width, 90 m. from front to back, and 50 m. in height. This will have supported a pillar. Similar but slightly smaller blocks form the ends of the three side-walls of the porticoes and probably supported some form of *anta*. They appear in the photographs in Pl. III, *a*, and in Pl. IV, *c*, *d*.<sup>1</sup> The central block of this portico and the two anta-blocks rest on a row of squared stones, which are laid on the foundation course and serve as a paved border to the portico. The open front of the portico is only 1·50 metres deep, and at the back of this space a wall on the right partly shuts off the inner room (**A 13**). This is a step higher than the entrance room and is surrounded by the remains of a paved margin. The floor is of hard plaster and in the middle, resting on slabs, is a square limestone block to support a central column. One of the stones upon which this block rests is the part of a door jamb with a recess on one side, which clearly came, like the threshold, from an earlier building. Its inner boundary is formed by three more of these square blocks with paved openings between them, which lead into a large inner space (**A 14, 15, 16**). The right-hand block was clogged with some later building masonry, possibly Greek, as the plan indicates, but more probably belonging to some later alteration of the Minoan plan, such as has been observed in the smaller portico. The interior space is divided into three rooms (**A 14, 15, 16**), but the walls of these seem from their level and type of construction to belong to the Late Minoan I building rather than to the period of the portico; it is, however, always possible that they may have served as the foundation to walls of the later time.

The walls marked on the plan as Greek occur on three parts of the site; over the courtyard in Block **A** (**A 11, 12, 21**), over the rooms **A 6, 7, 8**, and in the central court between the three main blocks of building. They were all very carelessly built of roughly dressed stones without mortar, and so badly preserved that no clear plan could be recovered. They were recognised as Greek by the presence of numerous fragments of pithoi with impressed ornaments,<sup>2</sup> of which a few examples are given on Pl. V,

<sup>1</sup> The photograph of Pl. IV, *c*, shews a block on the edge of the portico by the eastern anta which does not appear in the plan. It spoils the symmetry of the portico, and, as its position is clearly intentional, must belong to some later modification of the house.

<sup>2</sup> The only fairly complete piece was the upper part of a pithos found in **A 7**.

by a number of cooking pots of distinctly un-Minoan forms, by the absence of any Minoan sherds, and by their being clearly stratified above the walls of the Late Minoan III houses. It is occasionally difficult to distinguish between these Greek walls and additions to the Minoan houses, but in the three regions just mentioned the evidence is unmistakable. The plan also shews that there was a complete break between the Minoan and the Greek houses, for the latter are built without any consideration for the Minoan walls below them. There is unfortunately little evidence to shew how long the site was uninhabited, but the lapse of time between the Late Minoan III houses and the Greek period, which on the evidence of the pithoi would hardly seem to be earlier than the seventh century, must have been counted in centuries. It is noticeable that the plan gives no countenance to the idea that the Greeks may have settled in the ruins of the deserted Minoan houses. The evidence is all in favour of a complete break in the habitation of the site.

### § 3.—*The Bee-hive Tomb.*

The valley which runs up behind the village of Pláti towards the height of Aféndi Sarakinós has already been mentioned as the site of the cemetery.<sup>1</sup> The lower part of the valley, which is called τὰ Σκαλιά, has been planted as far as the ground permits with vines; at the bottom of the valley these are in pockets of soil between the outcrops of rock, and further up there has been a certain amount of the usual terracing. We heard a good deal about the discovery of tombs in this region, but we were able to locate only one, and this we excavated in the last days of the campaign. It lies low down in the valley in the middle of a small earthy hollow which has been planted with vines by the owner, Nikolaos Matthaïoudakis of Psykhró. It is a bee-hive tomb with a dromos, but when we arrived the crown of the dome had disappeared leaving a hole in the ground, through which the upper part of the interior as far as half-way down the door of the dromos was exposed. Of the outer end of the dromos there was no indication. The level of the earth inside the tomb was 1·15 metres below the general surface of the field and ·75 metre below the crown of the dome. We began the excavation by removing the earth from the bee-hive

<sup>1</sup> The upper part of this valley with the peak of Aféndi Sarakinós on the right, form the background of the view in Pl. III, *d*.

and the dromos through the hole in the dome. It was clearly the result of gradual silting up, and nothing was found in it until just below the level of the floor of the dromos. Here we found some scattered human bones, and below these some flat stone slabs, and below these again the clay larnax, of which a separate drawing is given in Pl. VII, 1.

The method of construction of the tomb is shewn in the plan and section on Pl. VI, which are due to Mr. Droop. The larnax was placed at the bottom of a pit below the level of the lowest course of the dome. This pit was filled up to the level of the top of the larnax and on the surface thus made flat stones were placed to protect the larnax from pressure. At this level the bee-hive dome and dromos were begun, and at some time there was a second burial, when the bones which we found above the slabs were deposited. An examination of the dromos brings out a curious point. It will be seen from the drawings that it has a length of about one-and-a-half metres, and, instead of leading to an open entrance, is stopped with a few stones piled up against a face of natural rock. It is therefore plain that the larnax was not introduced into the tomb through the dromos, and that, as it can hardly have been introduced through the unfinished dome, the whole construction of the tomb is subsequent to the deposition of the larnax. Before discussing this arrangement further it will be well to see what indications of date are furnished by the burial itself.

The only object found was a small plain jug with a narrow neck and globular body; this was with the bones in the larnax. The larnax itself was much broken, but the fragments were all in their original position, which suggests that the breaking was due to pressure of the earth rather than to any violence at the hands of pillagers of the tomb. It is of a well-known Cretan type; an imitation in clay of a wooden chest, of which the sides consist of framed sunken panels. The lid is gable-shaped. Both it and the side panels are pierced with holes.<sup>1</sup> These chest-larnakes apparently occur all through the Late Minoan III period, but a study of this Pláti example will shew that it is likely to be very late in the series. The better examples are very close to the wooden model. The panels are large and comparatively deep; the framing bands, whether

<sup>1</sup> Larnakes of this type have been often found in Cretan L. M. III tombs. The larnax cemetery found by the sea at Palaikastro (*B.S.A.* x, pp. 227 *sqq.*) shews that this chest type is contemporary with the commoner bath-shaped larnakes.

at the corners or up the middle of the long side, have the narrowness natural to the wooden construction. The Pláti larnax has, on the other hand, small shallow panels with frames of a quite disproportionate width, a divergence from the wooden original which suggests a late date. The lid also has no panels, but is left plain and the ridge piece, instead of being firmly modelled, has a clumsy shapelessness which preserves very little of its wooden original. A good early example is the finely painted larnax found at Palaikastro (Pl. VII, 2), and a comparison with it clearly shews the degenerate character of the Pláti larnax.<sup>1</sup>

The structure of the tomb itself equally suggests a late date in Late Minoan III and some influence from the mainland of Greece. The placing of the body, in this case in a larnax, in a pit sunk in the floor of the domed tomb-chamber, is clearly comparable to the burial cists found in the floor of some of the great mainland bee-hive tombs<sup>2</sup>; a parallel which disposes of any possibility that the bee-hive might be of later date and have no connexion with the burial of the larnax. But the construction of the dromos shews that the builders were imitating a type of tomb which they did not understand; they made a dromos because it was a recognised part of a bee-hive tomb, but they were unaware of its use as a practicable entrance to the tomb.

The conclusion would seem to be that late in the Late Minoan III period the people of Pláti adopted a foreign type of tomb, probably an importation from the mainland of Greece, the theory of which they only imperfectly understood, and that they used this unfamiliar construction to house the clay larnax of the old native system of burial.

#### § 4.—*The Minoan Occupation of Lasithi.*

It has been said above that none of the finds at Pláti can be placed earlier than Late Minoan I, and the same is true of the objects found in the cave of Psykhró. In the report of the excavation of the cave Mr. Hogarth indeed speaks of Kamares pottery, but in the year 1900 this name was given to all Minoan pottery with a dark ground and a design in white, and he tells us that the added red and yellow paint of the pottery from the Kamares cave and the Knossos houses did not occur on the Psykhró

<sup>1</sup> The Palaikastro larnax after *B.S.A.* viii, Fig. 15, p. 298.

<sup>2</sup> *E.g.* at Orchomenos, at Thorikos, and in one of the tombs at Mycenae. Cf. Tsountas and Manatt, *The Mycenaean Age*, ch. vi.



pottery, and also that no sherds were found with the plastic 'finger-work' ornament which is so common at Knossos and on all the Middle Minoan ware found in the Messará district. The decoration consisted of white patterns, either geometric or floral, on a dark ground.<sup>1</sup> This style is now known to be very common in Late Minoan I, and similarly painted cups were found in abundance in the two pits full of pottery which Mr. Hogarth cleared at Zákro.<sup>2</sup> It may therefore be taken that the first settlement at Pláti was contemporary with the beginning of the cult of the Psykhró cave and that, whatever may be the date of the latest finds from Pláti and the chronological significance of the break between the Minoan and the Greek houses, they both lasted on into the Greek period.

Now that it is known, largely from Dr. Xanthoudides' excavations at Koumása and the neighbourhood, how thickly the Messará plain was inhabited in Early and Middle Minoan times, the question naturally arises why a district so suitable for the cultivation of corn as the Lasithi plain was left uninhabited until so comparatively late. Mr. Hogarth suggests that the Psykhró cave may at one time have been a *katavothra*, in which case the present plain would have been a large deep lake, and the site of Pláti, and indeed of all the modern villages which fringe the plain, would have been submerged far below the surface of the water, and the steepness of the hills at the level of the cave would have left no room for either villages or cultivation. The possibility of this obviously depends, as Mr. Hogarth has pointed out, on the level of the cave being lower than the lowest point of the rim of mountains which surrounds the plain. On this view the lake must at some period have emptied itself by the opening of a *katavothra* at the level of the plain, presumably the present one which opens close to the road to Lyttos, and the transformation of the lake into a rich alluvial plain would then have attracted settlers from the surrounding regions. One point seems clear: the absence of any layer of peat in the plain shews that it was never a shallow lake or marsh like Kopais, where the ground is

<sup>1</sup> *B.S.A.* vi, pp. 101 *sqq.* and *J.H.S.* xxi, p. 142. It may be noted that, although the plastic ornament is so rarely found in the Middle Minoan pottery from sites to the east of Dikté, it would yet be expected in Middle Minoan from Lasithi, as the cultural connexions of this mountain district would be likely to be not so much with the east, but by the much easier pass over the hills which leads to the west by way of Lyttos.

<sup>2</sup> This pottery is published in *J.H.S.* xxiii, pp. 248 *sqq.* The present writer remembers going over a number of baskets of sherds from Psykhró in the old Museum at Candia at about the time he was working at the Zákro pottery, and noticing the resemblance between them.

covered with a thick layer of peat, the result of the growth and decay of marsh plants through many centuries. Nothing of the sort is to be found in Lasithi, where the layers of alluvial soil and lower down of gravel, reach, as modern wells shew, a depth of at least 20 or 25 feet. It may therefore be concluded that in the period before Late Minoan I the basin was either a deep lake or was left empty, not because it was not suitable for habitation, but because there was no sufficient impulse to bring people to this comparatively inclement region. This does not of course exclude the possibility that the inhabitants of the neighbouring parts of the island may have come there temporarily to sow and reap and graze their flocks, just as at the present day the people of Kritsá come up to their dairies and temporary dwellings in the plain of Katharó. It may be noted in conclusion that Lasithi was again deserted, although for a different reason, during the Venetian occupation of Crete, when the authorities, Dr. Xanthoudides has told me, forbade any one under penalty of mutilation to enter Lasithi, because of the difficulty of controlling the movements of the inhabitants of a district so difficult of access and so easy to defend.

R. M. DAWKINS.

## THE TSAKONIAN DIALECT.—II.

THE folk-tales and translations which follow are given as being the best means of illustrating the dialect of Tsakonia.<sup>1</sup> They were in every case taken down in the village to which they are assigned and from a native, and were not collected without some difficulty as the popularity of story-telling of this kind no longer exists or perhaps never had any strong hold over the district. This of course is true generally of the mainland of Greece to-day as opposed to the Aegean islands. The speaker generally appeared rather confused as if he (or she) did not remember or did not understand the plot of the story.

### LENIDHI.—I.

Νια φορὰ τσ' ἔναν δζαιρὲ ἡῆγαιῖ δύοῦ γειτόνισσαι τσ' ἡῆγαιῖ θένδε να ζάνι τ'ον ἄγιε Γζάρδζι, τσ' ἄῆγαιῖ νια σατέρα. ἀφ' οὗ ἡῆγαιῖ ἔῆγουνδε τ'αμ βορέια ἐρέκαῖ νια τσέα· ἐτύβε ἀ πρώτε—δεν ἀνοίε ὁ πόρε· ἐτύβε τσαι ἀ ἄβα· ἐτύβε τσ' ἀ σατέρα—ἀνοίε. μόλις ἐμβάτσε τάσου ἐτήνα ἀ σάτη, ἐκλείτσε ὁ πόρε, τσ' ἀ σάτη ἐκι βούα. οἱ γειτόνοι ἐφύῆγαιῖ τσ' ἐζάκαῖ τ'ον ἄγιε· τσ' ἐζάτσε τάσου τ'α δζέα· ἐρέτσε νια πάκα τσαι ἐκι γράφα 'ὅποια θα μι ζβαήση θα νι ἄρου γουναῖκα.' ἀ Μαῖργούλα ἐκι βούα τσ' ἐπεράτσε ἕνα καῖτσι με τάσου Αρακίσοι τσαι ἀνδζε νι τα σάτη τσαι ἐκι φυάτ'α σαράνδ' ἀμέραι. . . .<sup>2</sup> ἐξυπνήε ὁ βασιλῆα τσαι ἐρέτσε ταν Ἀρακίνα τ'ο θρόνε· ὠράτσε τα Μαῖργούλα χάμου τριουφτά· ἐπέτσε, 'ὄκι φυάτ'α μι ἔνδαῖ να νι ἄρου γουναῖκα παρὰ μ' ἐ φυάτ'α ἀ Ἀρακίνα.' ἀ Μαῖργούλα ὕστερα ἐτ'άτσε, ὠράτσε ταν

<sup>1</sup> For the peculiarities of the dialect of Kastanitsa and Sitena see Part I, *B.S.A.* xix, pp. 157 ff. *passim*.

<sup>2</sup> Something appears to be missing here.

Ἄρακινα τ'ο θρόνε· δεν ἐνιλήτσε· ἐπέτσε νι του βασιλῆα, ' ὄσι ποίου μι κάτου τ'αν αὐλῆ ἕνα καλούχι να κασῆμα ; ' ὁ βασιλῆα ἀμέσως νι ἐγκίε τσαι ἐζάτσε ἅ Μαῤῥιγούλα τσ' ἐκι κασημένα τάσου τσ' ἐκι βουά. ἐκάνε τσαιρὲ να ζάη ὁ βασιλῆα τ'αν Ἀθήνα τσ' ἐζάτσε τσ' ἐκι ρωτοῦ του κοπέλε σι τσαι τα κοπέλα σι τσί εἰ θένδε να σι φέρη· τα Μαῤῥιγούλα νι ἐξεχάτσε· τ'αμ βορέια π'ἐμδαῆτσε να φύτση ἐθuhnῆτ'ε τα Μαῤῥιγούλα τσ' ἐγύρδζε κίσου να νι ρωτῆ· ἐζάτσε τσ' ἐνδούτσε τομ βόρε τσ' ἅ Μαῤῥιγούλα νι ἀνοίε· νι ἐπέτσε, ' ἐζὸν θα ζάου τ'αν Ἀθήνα· τσ' ἐσ τέα να δι φέρου ; ' νι ἐπέτσε ἅ Μαῤῥιγούλα ' να μι φέρερε το δέμα τα πινηγῆ το μαχαίρι τα σφαγῆ τσαι το σαπούνι ταρ ὑπομονῆ· να ζάρε τσαι σ' ἐξεχάρε, π'οι να μόλερε τ'α μισὰ τα πορέια να σταμακήση το βαπόρι τσαι να μὴν βορῆνερε να ταξιδέψερε τσαι να σι θuhnῆτ'ε κίσου να γύρερε να σ' ἄρερε.' τσαι ὁ βασιλῆα ἐζάτσε τ'αν Ἀθήνα τσαι σ' ἐψωνίε σ' ὄλοι του κοπέλαι τσαι τ'α κοπέλα, τσαι τα Μαῤῥιγούλα σ' ἐξεχάτσε, τσαι τ'α μισὰ τα θάσσα π' ἐκάνε ἐστάτ'ε το βαπόρι. τότε ἐζάκαἰ τσ' ἐρωτῆκαἰ το βασιλῆα μὴν ἐξεχάτσε τσίττα· τότε ὁ βασιλῆα ἐθuhnῆτ'ε τα Μαῤῥιγούλα ταμ βαρανῆλια τσ' ἐγύρκαἰ τσαι νι ἄηγαἰ τσ' ἐζάτσε τ'ον δόπο σι τσ' ἐζάτσε τσ' ἐμερῆιέ τ'ου κοπέλαι τσαι τ'α κοπέλα ὄτσι ἠῆγαι ἔχουνδε πετέ· ἐζάτσε τ'α Μαῤῥιγούλα να ράη τσί σι ἐκι θέα ἔνδαἰ τα πράματα· τσαι ἄμα φύνδζε ὁ βασιλῆα, ἐῆγρῶφτε ἀπ' ὄτσου ἀπὸ τομ βόρε· ἅ Μαῤῥιγούλα ἐβαλήτσε το δέμα τ'αἰ γόρδα τσαι το μαχαίρι χάμου τσαι το σαπούνι τ'αν ἄκρα, τσ' ἐκι ἀούα ' ἐκιὸν δέμα τα πινηγῆ τσ' ἐκιὸν μαχαίρι τα σφαγῆ τσ' ἐκιὸν σαπούνι ταρ ὑπομονῆ τσί να ποίου ; ' το δέμα ἐκι ἀούνδα, ' να πριτ'ῆρε, το μαχαίρι ' να θυθῆρε.' ' ἐκιὸν σαπούνι, τσί μ' ἐσ' ἀούνδα ; ' ὑπομονῆ' νι ἐπέτσε ζεἰ φορὲ, τσ' ἐκι ἔηγα να βάλη το λαιμὸ σι τ'α θελεία· ἐκακούτσε ὁ βασιλῆα τομ βόρε τσ' ἐμδάτσε τάσου τσαι νι ἀβράε, τσ' ἐτήνα ὄκι νιούα τσαι νι ἐπέτσε ὁ βασιλῆα, ' να μ' ἀλήρε τσ' ἐσ' ἔχα.' νι ἐπέτσε, ' να κατσάου ἐζὸν να δι φυάτσου σαράνδ' ἀμέραι, τσαι του τρῶνδα ὄχτῶρ ἀμέραι να περάη ἅ Ἀράκισσα τσαι να μι βάλη να κιούψου τσαι να ξυπνήσερε τσαι να ρέσερε ταν Ἀράκισσα τ'ο θρόνε τσαι να νι ἄρερε.' νι ἐπέτσε ὁ βασιλῆα, ' ὄσ' ἀούα μι· στάσου ὄρεγι τσ' ἐζὸν νι φκιάνου.' ἐζάτσε τ'αν Ἀράκισσα τσαι νι ἐπέτσε, ' ὄσ' ἀούα μι· του κατσοἰ ἀθρῶιποἰ τσί σ' εἰμ βοίνδε ; ' ἅ Ἀράκισσα ἐγεάτσε, νι ἐπέτσε ' ὄσι ξέρου τσί σ' εἰμ βοίνδε ; σ' εἰνι δεῆνδε τ'ου δὺ πόδε του ἀόγου τσαι ἕνα σάκκο κάρα, τσαι ὄνι ἔηγουνδα το σάκκο, ἐν' ἔηγουνδα το κομμάκι του ἀθρούπου.' ' νι ἐσ ξέρα π'οἰ νι ἐσ τέα ἐκιού.' τσαι νι ἐβαλήτσε τ'ου πούε του ἀόγου τσαι νι ἐμβοίτσε γουλία, τσαι ἀνδζε τα βασιλίσσα τσαι ἐζήκαἰ κα τσαι ἐνεἰ καλείτερα.

LENIDHI.—I. (*Translation.*)

Once upon a time there were two women neighbours and they were about to go to St. George's Church and they took a girl. As they were going along the road they found a house. The first one knocked—the door did not open. The other one knocked too—the girl knocked also—it opened. Hardly did that girl go inside, when the door closed, and the girl was crying out. The neighbours went away and went to the church, and she went inside the house. She found a flat stone, and it wrote, 'Whoever shall read me, I will marry her.' Marighula was crying out and a caique passed by with Arabs on board and took the girl and she was kept forty days. . . . The king awoke and found the Arab woman on the throne. He saw Marighula asleep on the ground. He said 'This one was not kept for me to take as wife, but the Arab woman was kept for me.' Afterwards Marighula got up. She saw the Arab woman on the throne. She did not speak. She said to the king, 'Are you not making me down in the yard a hut that I may sit down?' The king immediately made it and Marighula went and used to sit inside and cry. Time came for the king to go to Athens and he went and asked his maids and household what they wanted him to bring for them: Marighula he forgot. When he had started to go out on his road he remembered Marighula, and returned to ask her. He went and knocked at the door and Marighula opened it. He said to her, 'I am going to Athens, what do you want me to bring you?' Marighula said, 'Bring me the rope of suffocation, the knife of slaughter, and the soap of patience; if you go and forget them, when you have come half your way, may the boat stop, and may you not be able to travel, and may you remember to return and get them.' And the king went to Athens and bought the things for all the maids and the household, and forgot Marighula. When he had got half-way on the voyage the boat stopped. Then they went and asked the king whether he had forgotten anything. Then the king remembered Marighula's commission, and they returned and got it. And he went to his town, and he went and distributed to the maids and the household what they had said. He went to Marighula to see what she wanted with those things. And when the king had gone, he hid outside the door. Marighula put the rope on the hook (?) and the knife on the ground, and the soap in the corner, and said, 'You, rope of suffocation, and you, knife of slaughter,

and you, soap of patience, what am I to do?' The rope said, 'Choke yourself,' the knife, 'Stab yourself.' 'You, soap, what do you say to me?' 'Patience!' it said to her thrice; and she went to put her neck in the noose. The king broke in the door and went inside and caught her. And she did not hear. And the king said to her, 'Tell me what is wrong with you.' She said to him, 'That I should sit down to guard you forty days and after thirty-eight days that the Arab woman should pass, and put me to sleep, and that you should wake and find the Arab woman on the throne and take her.' The king said to her, 'You don't tell me! stay here and I'll catch her.' He went to the Arab woman and said, 'You don't tell me, what do they do to wicked people?' The Arab woman laughed: she said to him, 'Don't you know what they do to them? They bind them to the two feet of the horse and a bag of walnuts, and the walnuts do not come, the piece of the man comes.' 'You know it, who want it,' and he fastened her to the feet of the horse and tore her in pieces, And he took the queen and they lived happily ever afterwards.

## LENIDHI.—II.

Νια φορὰ τσαι έναν δζαιρὲ νια ἀλεποὺ ἕνα λιούκο τσαι ἕνα ὄνε ἐμβάκαϊ σ' ἕνα καΐτσι τσ' ἐτσινήκαϊ· τ'αμ βορεία π' ἠῆγιαϊ ἔῆγουνδε ἐπέτσε ἅ ἀλεπού, 'ἔατ'ε να ἀλήουμε του ἀμαρκήλε νάμου να 'ράμε ποίε ἐνι ἔχου του πρεσούτεροι τσαι ἔτενι π' ἐ θά 'χη του πρεσούτεροι να να πρίτσουμε.' ἀπὲ ἐπέτσε ἅ ἀλεπού, 'ἔζου ἀπὸ ἠγάνα κοτ'άρι π' ἔμα κρέφα.' ὕστερα ἐπέτσε ὁ λιούκο, 'ἔζου ἀπὸ ἠγάνα ρουφαλάτσι π' ἔμα τσ' ἔζου κρέφου.' ὕστερα ἐπέτσε ὁ ὄνε, 'ἔζου ἠγάνα μαρούλι.' ὕστερα ἐπέτσε ἅ ἀλεπού, 'ὁ ὄνε ἐνι ἔχου του πρεσούτεροι· ἔατ'ε να νι ξερίσουμε.' ἀπὲ ἀπέτσε ὁ ὄνε, 'σ' ενίου σ' ἐνι ἔχου γραφτὲ ὁ ἀφεῆγικὸ μι ἀκατούσε τ'ομ βούα.' ἐζάτσε ὁ λιούκο να σι 'ράη· νι ἐδούτσε νια κολοτσία τσαι νι ἐξερίε τ'α θύσσα· ἅ ἀλεποὺ ἀπὸ το φόβο σι ἐμβαίητσε τ'α κατάρκια· ὕστερα ἀῆγαρίε ὁ ὄνε τσ' ἅ ἀλεποὺ ἀπὸ το φόβο σι ἐῆgrenίστε τ'α θύσσα· ἀπὲ ἐζάτσε ὁ ὄνε, ἐρέτσε του ἀφεῆγικὸ τσαι ἐζήητσε κὰ τσαι ἐνεὶ καλείτερα.

LENIDHI.—II. (*Translation.*)

Once upon a time, a fox, a wolf, and an ass went into a caique and started off. As they were going along, the fox said, 'Let us tell our sins, to see which has the most, and let us drown him who has the most.' Then the fox said, 'I from a hen which I stole.' Then said the wolf, 'I

from a porridge (?) which I too stole.' Next the ass said, 'I stole a lettuce.' Then the fox said, 'The ass has the most, let us throw him into the sea and drown him.' Then the ass said, 'My master has written them on me on the bottom of my hoof.' The wolf went to see them. The ass gave him a kick and threw him into the sea. The fox from his fear went out into the rigging; afterwards the ass hee-hawed and the fox from his fear hung down into the sea. Then the ass went, found its master, and lived happily ever afterwards.

## MELANA.

Νια φορὰ ἔκι νια γρήα τσ' ἔκι ἔχα ζεὶ σατέρε τσ' ἐκόβαϊ ἀπὸ νία ρόκα  
 βαμβάτσι τσ' ἐπέκαϊ· 'ὄπα να νι νέη τελευταία θα νι κιάσουμε τσαι θα νι  
 γυμνούμε τσαι θα νι βράσουμε.' οἱ σατέρε νι ἐνέκαϊ τα ρόκα τσαι ἀραμάτσε  
 τελευταία ἂ μάτη τσαι νι ἐκιάκαϊ τσαι νι ἐγυμνούκαϊ τσαι νι ἐβαλήκαϊ τασ'  
 το λεβέτα· ἂ νία ἐκι κασιμένα τασ' τα σποῖα τσαι ν' ἦκι ἀούνδε σποῖλιου.  
 οἱ ἄλλοι σατέρε ἠῆγξαῖ ζούνδε τσ' ἂ ἄβα ὄκι ζούα· ὁ βασιλῆα ἐζάτσε τ'ον  
 ἄγιε τσ' ἐβαλήτσε κ'ὄα τ'ομ βόρε· ἐζάτσε να περάη ἂ σποῖλιου τσ' ἐκ'ὄατσε  
 ἂ κουνδούρα σι τσ' ἐζάτσε τᾶσ' τον ἄγιε τσ' ἐμβοίτσε το σταυρὲ σι· ὕστερα  
 ἐμβαήτσε τσ' ἐκι τραβήνδα να μβάη ἂ κουνδούρα τσ' ὄκι μδαῖνα τσαι νι  
 ἀφήτσε τσ' ἐζάτσε τ'αν δζέα. τότε ὁ βασιλῆα ἐπέτσε· 'τσούνερ ἐνι ἂ  
 κουνδούρα;' τότε νι ἀθιὰ ἐπέτσε· 'ἐνι ἔχα τσ' ἐζὸν νια ἀθιὰ· για να ζάη  
 πρώτε να ἐνι δικὰ σι.' ἐζάτσε τσαι νι ἐνένδζε τ'ον ἄγιε, τσ' ἂ κουνδούρα  
 ἐκι παρῖα ἴσα τομ βούα σι· ὁ βασιλῆα ἐπέτσε· 'θα νι ἄρου γουναίκα.' τσαι  
 νι ἄνδζε γουναίκα. τότε ἂ ἀθιὰ σι ἐπέτσε τ'α βασιλίσσα 'ἐα να ζάμε τ'ο  
 κηηγάδι τσαι να ῥάμε ποία ἐνι ἂ καλιτέρα,' τσαι νι ἐμδαλήτσε του καρφίτσαι  
 τσαι νι ἐδούτσε νία τσ' ἐζάτσε τασ' το κηηγάδι. ὄρπα ἐθυτρούτσε ἐνα  
 κυπαρίσσι τσαι ἄμα ἐκι περονὸ ὁ βασιλῆα ἐκι τ'ένδα τ'α μεσουράνια τσ' ἄμα  
 ἐκι περονὸ ἂ ἀθιὰ σι ἐκι σιχννούμενε να νι φάη. τότε ὁ βασιλῆα ἐκι ἔχον  
 ἐνα βάννε τσ' ἐνα βούλε, τσ' ἐκι ἔηγου ὁ βάννε τάν' το κηηγάδι τσ' ἐκι ἀὸν  
 'βὰ μαρούα' τ'ο κηηγάδι τσ' ἐπέτσε ὁ βασιλῆα· 'να νι θύουμε το βάννε,'  
 τσαι νι ἐθύκαϊ. ὕστερα ἐκι ἔηγου ὁ βούλε τσ' ἐκι ἀὸν· 'κουκουρίκου,  
 μαρούα' τ'ο κηηγάδι. ὁ βασιλῆα ἐπέτσε 'να νι θύουμε το βούλε.' τσαι νι  
 ἐθύκαϊ. ὕστερα ἐπέτσε να νι κόψουμε το κυπαρίσσι,' τσαι νι ἐκόβαϊ.  
 ἐπεράτσε νια γρήα τσαι νι ἐπέτσε 'ὄσ' δίου μι δὺ καλίζα να σι βάλου τ'ανι  
 κ'άρα;' τσαι νι ἐδούτσε τσαι σ' ἐβαλήτσε ἀπο κίσου το σενδούτσι. ἔτραϊ ἂ  
 γρήα ἐκι ἔηγα τ'ου δουλείαι σι· τὰργὰ π' ἐκι παρῖα ἐκι ἐρέχα ὄλοι του  
 δουλείαι σι βοιτοῖ τσ' ἐπέτσε τ'ου γειτόνε· 'ὄτ' ἀούνδε μι πῶιε σ' ἐμ βοίου

του δουλείαι;’ οί γειτόνε ἐπέκαϊ· ‘οί συγγενήδε δι σ’ εἶνι ποίνδε.’ ἡ γρήα ἐπέτσε· ‘ἐζού ταῖ γράκα νι ενι ἔχα κονδὰ· ἀπο κιὰ θα βάνι; ἐζού θα παραφυάτσου να ράου ποίερ ἐνι.’ ὄρπα π’ ἐκι κασιμένα ἐμβαήτσε να γουναίκα τσαι ἀνάβε τανι κ’άρα τσ’ ἐκι μαγειρέῃγα. ὕστερα νι ἐπέτσε ἔτρανι τα γρήα· ‘ἔῃγι το φαῖ να νι ἀποσοῦερε τ’ο βασιλήα.’ ἡ γρήα νι ἀνδζε τσαι νι ἀποσοῦτσε τ’ο βασιλήα· πρώτε γουλία ὁ βασιλήα ἐρέτσε ταῖ γαρφίτσα· ὕστερα νι ἐπέτσε· ‘ἔῃγι το σομό να νι ἀποσοῦερε τ’ο βασιλήα.’ πρώτε γουλία π’ ἀνδζε ὁ βασιλήα ἐρέτσε το δαχτυλίδι· ὁ βασιλήα νι ἐπέτσε ἔτανι τα γρήα· ‘ποίε σ’ ἐνι ποίου ἐνδαῖ τα σομά;’ ἐτήγα νι ἐπέτσε· ‘ἐζού.’ ὁ βασιλήα νι ἐπέτσε· ‘ἐζού θα μόλου τ’αν δζέα δι να παραφυάτσου.’

ὁ βασιλήα ἐζάτσε τσαι κατσάτσε τάν’ τον θριγκὸ τσ’ ἐνδουτ’ε σαν με ζαθίλαι· ὁ βασιλήα ἐπέτσε· ‘ποίερ ἐνι ἀπὸ κατούσε;’ ἡ γρήα ἐπέτσε ‘ἡ κλώσα με τα πουλία.’ τσ’ ὁ βασιλήα τ’αῖε τσ’ ἐρέτσε τα βασιλίσσα τσαι νι ἀνδζε ἀπὸ τα χέρα τσαι νι ἀποσοῦτσε τ’αν δζέα· τ’αν ἄβα ἀθιὰ σι νι ἐπέτσε· ‘ἀναψε το φούρνε τσ’ ἐνι ἔχου ἐνα βάννε να φτάου.’ ἔτραϊ ἀνάβε το φούρνε· ὕστερα νι ἐκιάκαῖ τσαι νι ἐβαλήκαῖ τὰς’ το φούρνε τσ’ ἐδάτσε.

MELANA. (*Translation.*)

Once there was an old woman, and she had three daughters, and they cut cotton from one staff; and they said, ‘Whoever spins it last, we will take her, and strip her, and boil her.’ The daughters spun at the staff and the mother remained last, and they took her and stripped her and put her into the pot. One of them used to sit in the ashes, and they called her Cinderella. The other daughters were eating and the other one was not eating. The king went to the church and put glue at the door. Cinderella went to pass by, and her slipper stuck, and she went into the church and made her cross. Then she went out and was pulling to get her slipper away, and it would not come off and she left it and went home. Then the king said, ‘Whose is the slipper?’ Then a sister said, ‘I have a sister: let her come first so that it may be hers.’ She went and brought her to the church, and the shoe fitted her foot. The king said, ‘I will take her to wife,’ and he took her to wife. Then her sister said to the queen, ‘Come, let us go to the well and see who is the better’; and she took out her brooches and gave her a blow and she went into the well. There a cypress grew, and when the king passed it rose up to the sky, and when



her sister passed it would spread itself out to eat her. Then the king had a lamb and a cock, and the lamb used to go on to the well and say 'Ba ! old woman' to the well ; and the king said, 'Let us kill the lamb,' and they killed it. Afterwards the cock would go and cry 'Cock-a-doodle, old woman' to the well. The king said, 'Let us kill the cock,' and they killed it. Afterwards he said, 'Let us cut down the cypress,' and they cut it down. An old woman passed and said to him, 'Aren't you giving me two faggots that I may put them on the fire?' And he gave her them, and she put them behind the chest. This old woman used to go to her labours. In the evening when she came she used to find all her tasks done, and she said to the neighbours, 'Don't you tell me who does my tasks?' The neighbours said, 'Your kinsfolk do them.' The old woman said, 'I have the key by me ; where will they get in? I will watch to see who it is.' There where she was sitting a woman came out and lit the fire and was cooking. Afterwards she said to this old woman, 'Take this food to the king.' The old woman took it and bore it to the king. At the first mouthful the king found the brooch. Afterwards she said to her, 'Take this food to the king.' The first mouthful the king took he found the ring. The king said to this old woman, 'Who makes these dishes?' She said to him, 'I.' The king said to her, 'I will come to your house to watch.' The king went and sat on the basket (?), and was struck as if with needles. The king said, 'Who is underneath?' The old woman said, 'The hen with the chickens.' And the king lifted it up and found the queen, and took her by the hand, and took her away home. He said to her other sister, 'Light the oven ; I have a lamb to roast.' She lighted the oven. Afterwards they seized her and put her in the oven and she burned.

#### TYROS.

Νια φορὰ τσ' έναν δζαιρὲ ἡῆγλει̇ ζεὶ ἀιθόινε τσ' ουῆγλαι̇ ἔχουνδε ἀνδε τσ' ἡῆγλαι̇ θένδε να ζάνι κοπέλια ἀπὸ τα φτώχια. λοιπὸν ἂ πορεία π' ἡῆγλαι̇ θένδε να ζάνι τ'ο βαπόρι, περάκαϊ ἀπὸ τον ἄγιε Λίδι. λοιπὸν π' ἡῆγλαι̇ θένδε να βάνι τασ' τον ἄγιε Λίδι, ἐρέκαϊ ἓνα παπὰ τσαι σι ἐπέτσε ὁ παπά, 'ἐνεὶ ὄρεγι σ' ἔνδανι τα χώρα ἔμμε συνειθούνδε ν' ἀλήνουμε ψέμματα, τσ' ὄπε ἔ ξέρου τα πρεσοῦτερα ψέμματα ἐν ἀρῆκ'ου ταμ βερουσία του ἰουνέ. λοιπὸν ἐκαῆγλιούτσε τσαι σι ἀνδζε ὁ παπὰ να ζάνι τάν δζέα σι. λοιπὸν

ἐφαήκαϊ καὶ τὰργὰ τσ' ἀποτσέ φαήκαϊ, ἀρχινιάϊ τα ψέμματα· ἀρχινίε ὁ παπὰ τα ψέμματα τσ' ἐπέτσε 'νία βοὰ ἀῖγα τον δουφέτσι μι τσ' ἐζάκα για ἀγού· ἀφ'οὺ δεν ἐρέκα ἀγού ἐτουφετσία ἕνα σῖνα τσ' ἐπεράτσε το βόλι ἀπὸ το ἕνα μέρι τ'ο ἀλλιου.' λοιπὸν ἀρχινίε τσ' ὁ ἀεΐτερε ἀϊθι τα ψέμματα, τσ' ἐπέτσε, 'νία βοὰ ἐμαϊ ἔχουνδε ἑκατομύρια προύατα τσ' ἐμαϊ κιάνκε πρεσοὺ γά.' λοιπὸν ἐπέτσε ὁ παπὰ, 'ἔκεινι ὃ τσίπτα· ὄσι ξέρου ψέμματα, γιατίσι τον ἕνα χρόνε ἐνι εὐτυχία τσαι τον ἄλλε δυστυχία.' λοιπὸν ἀρχίε ὁ δεύτερε ἀϊθι τσ' ἐπέτσε, 'ἕμα ἔχου τόσου χούρε τσ' ἕμα ποίου τόσα ἑκατομύρια κοιά φαέ.' λοιπὸν ἐπέτσε ὁ παπὰ πάλι, "κάτου d' ἐνι ἔχου· ὄσι ξέρου ψέμματα.' λοιπὸν ἀρχινίε ὁ μισοῦτερε τσ' ἐπέτσε, 'π' ἐνάτ'ε ὁ παποῦ μι ἕμα δεκατέσσεροι χρόνου τσ' ὄκι ἔχου παπὰ να βαφκίση τομ βαποῦ μι, τσι νι ἀῖγα να νι ἀποσοῦ να νι βαφκίσου τ'ου οὐρανέ, τσ' ἐβαλήκα νια τριχία τσ' ὄκι σοῦνα, τσαι ἀῖγα ὕστερα νια κοτσιτία τσ' ἐβαλήκα για να μβαῖου τάνου. λοιπὸν ὄρπα π' ἐμβαήκα ξυκάζου ὄγι τσαι ὄπὰ δεν ὠρίκα ἡγανένα· κανία φορὰ ὠρίκα το θεὸ τσ' ἐζάκα τσι νι ἐβαφκία. λοιπὸν κιάνου να κ'αμβάου τ'α μισὰ ταῖ γροσιτία μ' ἐκίτσε βρέχο· λοιπὸν ὄμα ἔχου μέρι να ζάου να γρῖουφτου. ε(ἡ)γρῖούμα σ' ἕνα κ'ομβὸ κοτσιτία π'ἕμα παρίου παρακάτου με τομ βαποῦ μι. ἐκόφτε ἡ κοτσιτία τσ' ἐτσιτά σ' ἄλλιου μέρι· ὄπὰ π'ἕμα ἔῃγου ἐρέκα νια καῖρὰ τσαι ἀῖγα πέῤουνε τσαι ἀνεμούκα τίν da καῖρὰ τσαι δεν ἐτσιτάε ἡγανένα. ὕστερα ἀῖγα ἄμμου τσαι ἀνεμούκα τὴν daῖ γαιρὰ τσαι τσιτάνι ὄα τα κάρα τσ' εκαῖούκα ἕνα κάρι τσ' ἐβαλήκα τασ' τα θάσσα τσ' ἐμβάκα τάσου με τομ βαποῦ μι. τ'ο πέαγο π'ἕμα ἔῃγου ἐρέκα κίτσι προύατα. ὄρπα π' ἡῖγίε ὠρούνδε τα προύατα ἐπεράτσε ἕνα ποιῖγικὸ τσι νι ἐβαλήκαϊ οἱ κούνοι ἀπουρτέσε τσαι οἱ ἰοπάνιδε με του μαῖγούρε. λοιπὸν ἐφύῃγαῖ ὁ ἔῃγονε με τομ βαποῦ τσ' ἐφύῃγαῖ ἀπ' ὄρπα. ὄπὰ π' ἡῖγίε ἔῃγουνδε ἐδιψάκαϊ τσ' οὕῃγαῖ ἔχουνδε ὕω. γανία βοὰ ἐξυκάε ἕνα γιούρε τσαι ὠράτσε σε νία γράβα ὕω. λοιπὸν ὄκι ποροῦ να κῆ ὕω. λοιπον ἐπέτσε, 'τσ' ἐ πρέπουνδα να πῆ γανένα.' λοιπὸν ἐπέτσε μοναχὸ σι, 'να κόψου τα τσουφὰ μι για να κίου ὕω.' λοιπὸν ἐῃγίκα ὕω, χονδίακα τσ' ἐφύῃγα. λοιπὸν ὄπὰ π'ἕμα ἔῃγου γανία βοὰ ἐθνήμα τα τσουφὰ μι τσ' ἐγύρκα κίσου για να νι ἄρου. γανία βοὰ ὠρίκα νι ἄλεποῦ ἔχα τα τσουφὰ μι· ἐπερικαλέκα νι να νι ἀφή τα τσουφὰ μι· γανία βοὰ νι ἀφήτσε τα τσουφὰ μι τσι νι ἀῖγα· νι ἐκ'ὀλια τ'ο λαιμὸ τσ' ἐφύῃγα τσι νι ἐπέκα τ'ομ βαπά, 'ἐκιὸν παπὰ να νἄρερε τα μαῖγούρα di τσαι ταμ βαπαδιά τσαι να φύτσερε. τσ' ὁ μισοῦτερε ἀϊθι να νάῖρη ταμ βερουσία του παπὰ.' τσαι ἔτρου ἐτσιδέρβε ὁ μισοῦτερε ἀϊθι ταμ βερουσία του παπὰ με τα ψέμματα.

TYROS. (*Translation.*)

Once upon a time there were three brothers and they had no bread and they were about to go into service owing to their poverty. Now as they were going on the road to the steamer they passed Lenidhi. Now when they were about to enter Lenidhi, they found a priest, and the priest said to them, 'We here in this village are accustomed to tell lies, and whoever knows the most lies takes the other's wealth.' Now it grew dark and the priest took them to go to his house. So they had a good meal in the evening, and after they had eaten they began the lies. The priest began the lies and said, 'Once I took my gun and went after hares; since I did not find hares I shot at a mountain, and the shot passed right through.' Now the eldest brother also began the lies and said, 'Once we had millions of sheep and we got much milk.' So the priest said, 'That's nothing, you don't know how to lie, because one year there is a good fortune and the next bad.' So the second brother began and said, 'I used to have so many fields and I used to make so many millions of bushels of food.' So the priest said again, 'I have beaten you, you don't know how to lie.' So the second brother finished, and the youngest began and said, 'When my grandfather was born I was fourteen years old, and there was no priest to baptise my grandfather, and I took him to bring him to heaven to baptise, and I put up a rope and it did not reach, and afterwards I took a pumpkin and put it so as to get up. Well there where I got up, looking here and there I saw none. One time I saw God and I went and baptised him. Well catching hold to come down, rain caught me half-way down the pumpkin. Now I had nowhere to go to hide. I hid in a knot (?) of the pumpkin where I was coming down with my grandfather. The knot (?) broke and I fell to another place; there where I was going I found a walnut tree; and I took stones and threw them up on to the walnut tree, and not one fell. Then I took sand and threw it up in to the walnut-tree and all the walnuts fell, and I cracked a walnut and put it in the sea, and got in with my grandfather. As I went in the ocean I found some sheep. There<sup>1</sup> where they saw the sheep a mouse passed, and the dogs put it in front and the shepherds with their crooks. Well the grandson and his grandfather went away and departed thence. Where they were going they grew thirsty, and they had no water. At last he looked round and saw

<sup>1</sup> Here the speaker carelessly changed from first to third person.

water in a hole. Now he was unable to drink the water, so he said, "What ought one to do?" So he said to himself, "I'll cut off my head so as to drink." So I<sup>1</sup> drank water and sated myself and went away. Now as I was going away at last I remembered my head, and I returned to take it. At last I saw a fox with my head. I besought it to leave my head. At last it left my head and I took it. I stuck it on to my neck and went away, and I said to the priest, "You, priest, take your stick and your wife, and the youngest brother shall take the priest's wealth"; and thus the youngest brother fleeced the priest of his wealth with his lies.

## KASTANITSA.

"Ἐκι μια βασιλίσα τσ' ἐκι κασιμένα ἀπο τάσου το κρυσταλένιο δζάμι· ἐκι κασιμένα τσενδίχα· ἔζουπάτσε τα χέρα σι τσ' ἐμδαήτσε αἷμα τσ' ἐκι τσιτ'ένδα τσαι χιόνα, τσ' ἐπέτσε· 'θέ μι, δί μι μια σάτη να λάμδη ὄπ'ουρ ἐνι ἅ χιόνα τσαι το αἷμα να ἐνι κοτσινέ τ'ο μουτσουνέ σι.' ἐγευνάτσε τσ' ἐμδῆτσε μια σάτη τσ' ἐ λάμδα σαν da χιόνα σαν do μάλι το κοτσινέ. δεν ἐδιατηρήτ'ε τσ' ἐπενάτσε τσαι νι ἀφήτσε τα σάτη τσαι νι ἐβαλήτσε τ'αμ βαραμάννα τσ' ὁ βασιλήα ἐπανδρεύτε τσ' ἀνδζε ἄλλα γουναῖκα· ἅ γουναῖκα ἔτραϊ ἐκι μάνδισσα· νι ἐκι ζηλέηγα γιατσὶ ἐκι ὄμορφο· το σάτερι πενδέμορφο ἐκι ζηλέηγα τσ' ἐκι ἔηγα τ'οῖ γαθρέφτα, 'καθρέφτα μι, καθρέφτα μι ποῖα ἐνι ὄμορφο σ' ἔνδανι τα χῶρα;' 'ὄμορφο ἔσι ἄλλὰ σαν daμ βενδέμορφο ὄχι.' νι ἐκι ζηλοφτανούα τσ' ἐπέτσε τ'οῖ περέτρον, 'ἄρτε μι νι τσ' ἀποσοῦτε νι σ'ένα σίνα τσαι θύτε μι νι τσαι βάλτε νι ταῖ γορδία σι τσαι τονι ἐψιλλέ σι τσαι φέρτε νι να σι φάου.' σι ἐπέτσε ἅ σάτη, 'γιατσὶ να μι σκοτούτ'ε; ν' ἀφήτ'ε μι σ' ἔνδενι το σίνα.' 'νάμου ἐπέτσε ἅ μαχεία δι γι να δι βάλουμε ταῖ γαρδία δι τσαι τοιρ ἐψιλλοῦ δι.' 'γιατσὶ να μι σκοτούτ'ε; ἀφήτ'ε μι σ' ἔνδενι το σίνα να μι φάνε τὰ θερία.' 'με πὶ καρδία ν' ἀποσοῦμε τ'α μαχεία δι; γιατσὶ ε θέλα να σι φάη.' ἐμδαήτσε ἕνα σκανζόχερε, τσ' ἐπέτσε, 'θύτε νι το σκανζόχερε τσαι βάλτε νι ταῖ γαρδία σι τσ' ἀποσοῦτ'ε νι τ'α μαχεία μι.' νι ἀφήκαῖ τα σάτη τ'ο σίνα τσ' ἐφύηγαῖ οἱ δούλου· ἐζάκαῖ τ'α βασιλίσα, τσ' ἐρωτήτσε, 'νι ἔσκοτούκατε, δίτε μι ταῖ γαρδία σι να νι φάου.' ἅ σάτη ἐζάτσε· ἐρέτσε μια δζέλα τσ' ἐμβάτσε τάσου τσ' ἐκατσάτσε τσ' ἐρέτσε το τραπέζι στρουτέ τσ' ἐκατσάτσε τσ' ἐφαήτσε τσ' ἐζάτσε τ'αῖ γάμαρα τσ' ἐγύρε τ'ο κρεβάτι τσ' ἐπραγιάε. τὰργὰ ἐκάνανι οἱ δζουδζέριδε· ἐπέκανε, 'ποῖερ ἐκάνε ὄγι τάσου τσαι να φαήτση το σομὸ ἀνάβε το λύχνι;'

<sup>1</sup> Change to first person.

τσαι ἐξάκαϊ τσαι νι ἐρέκαϊ τα ὄατη πραγιάζα· τσαι οἱ πένδε δζουδζέριδε ἐκι παρακανδουμένοι να τ'άη να μῆ νι ξυπνίζουνδε τσαι να φοζάτ'η ἁ ὄάτη. νι ἐπέκανε, 'τσ' ἐσ' θέλα ὄγι π' ἐκάνερε;' σι ἐπέτσε ἁ ὄάτη, 'ἐμά 'χα μια μαζεία τσ' ἐκι κακὰ τσαι μ' ἀπολύτσε με τοι δούλου τ'ο σίνα να μι σκοτούνε τσαι δὲ μι σκοτούκανε τσ' ἐκάνα ἐζοῦ ὄγι πέρα.' λοιπὸν νι ἐπέκανε, 'τσύκα να μη μόλη.'

ἐζάτσε τ'οῖ γαθρέφτα τσ' ἐρωτήτσε τοῖ γαθρέφτα, 'γιὰ λάλε μι ἔδερι, καθρέφτα, ποῖα ἐνι ἁ ὄμορφο σ' ἐνδανι τα χῶρα;' 'ἐκιου ἐσ' ὄμορφο, μα σαν δαμ βενδέμορφο ὄχι.' 'μὰ ζοῦα ἐνι πάλι δὲ νι ἐσκοτούκανε μ' ἐγελάκανε οἱ δούλου.' λοιπὸν ἐτ'άτσε τσ' ἐφορέτσε βλάχικα, τσ' ἀνδζε χτένια τσαι τσατσάροι τσαι ἄλλα διάφορα πράματα, τσ' ἐζάτσε τσ' ἐζάτσε τσαι νι ἐρέτσε· 'χτένια, τσατσάροι,' ἐκι φωνιάνδα τσ' ἐμβαήτσε ἁ Πενδέμορφο ἀπὸ το παναθούρι. 'ἔλα να ράρε ὄτσ' ἐσι θέλα.' κατα δυστυχία ὄκι ἔχα τσατσάροι, τσ' ἐμβαήτσε ἀπὸ το παναθούρι τσαι νι ἐπέτσε· 'ἀνοιτσὲ μι, να νι ἄρερε ταν δζατσάρα.' νι ἐπέτσε, 'ὄμι ἀνοίνδα.' 'μείνε τ'ο παναθούρι,' νι ἀποκίτσε ἀπὸ το παναθούρι νι ἀνδζε ἁ ὄάτη τσ' ἐχτενίστε· μόλι νι ἐβαλήτσε τ'α τσουφύλα σι ἐπενάτσε. ἐζάτσε. ἐκάναϊ οἱ δζουδζέριδε τσ' ἐπέκανε· 'ἔ ἐκάνε τσ' ἐπενάτσε ἁ ὄάτη,' ἐκι σκοτουνομένα τσ' ἐξάκαϊ γιὰ να νι σαβανούνε, τσ' ἐρέκαϊ ταν δζατσάρα τ'α τσουφύλα σι, τσ' ἐμβαλήκαϊ ταν δζατσάρα ἀπὸ τα τσουφάλα σι τσ' ἐζωνδανούτσε ἁ ὄάτη. νι ἐπέκανε· 'ἐμεῖ θα ζάμε τ'α δουλεία νάμου τσαι μῆνι ἀνοίνδερε, γιατσὶ θα ξαρωτῆ τοῖ γαθρέφτα τσαι θα μόλη πάλι.' ἐζάτσε ἁ βασίλισσα τσ' ἐρωτήτσε τοῖ γαθρέφτα πάλι τσαι νι ἐπέτσε· 'καθρέφτα μι, καθρέφτα μι, ποῖα ἐνι ὄμορφο σ' ἐνδανι τα χῶρα;' 'ἔ ὄμορφο ἐσιν· σαν δαμ βενδέμορφο ὄχι.' 'βά,' ἐπέτσε, 'δὲν ἐπενάτσε πάλι.' ἀνδζε ζῶναι τσ' ἐζάτσε πάλι τσαι νι ἐπέτσε· 'ἔλα να δι δούμε μια ζῶνη να φορῆνερε.' νι ἐξεπλανέβε πάλι τα ὄάτη τσαι νι ἀνδζε τα ζῶνη τσαι νι ἐφορέτσε τσ' ἐπενάτσε. ἐκάναϊ τ'αργὰ πάλι οἱ δζουδζέριδε τσ' ἐπέκανε οἱ δζουδζέριδε· ἦκι βούνδε· 'ἄχ· ἐκάνε πάλι τσαι νι ἐπενάτσε· τσύκα,' ἐξάκαϊ να νι βάλουμε τα ζῶνη τσ' ἐζωνδανούτσε ἁ ὄάτη· ἐζάτσε ἁ βασίλισσα τ'οῖ γαθρέφτα πάλι τσ' ἐρωτήτσε· 'καθρέφτα μι, καθρέφτα μι, ποῖα ἐνι ὄμορφο σ' ἐνδανι τα χῶρα;' 'ὄμορφο ἐσιν· σαν δαμ βενδέμορφο ὄχι.' ἀνδζε μάλα τσ' ἐζάτσε τσαι νι ἐπέτσε· 'ἔλα να δι δοῦ ἕνα μάλι.' τσαι νι ἀνδζε ἁ ὄάτη τσαι νι ἐβαλήτσε τ'ο τ'ούμα σι τσ' ἐπενάτσε· ἐκάνανε οἱ δζουδζέριδε τσαι νι ἐρέκαϊ πενατὰ· ἦκι βούνδε· νι ἐσαβανούκανε· νι ἐβαλήκανε τ'ασου τ'α κάσσα τσαι νι ἀῖγανε νι ἀποσούκανε σ' ἕνα σίνα ὄπα π' ἦκι· νι ἀῖγανε τ'ο μεταλλεῖο τσαι δὲ νι ἐκάκούανε· λοιπὸν ἐπεράτσε το βασιλόπουλο π' ἐκι τσυνηγούνδα, τσαι νι ὠράτσε· σ' ἐπέτσε τοι δζουδζέριδε· 'δίτε μι νι, τσ' ἄς

ενι πενατά.' ὀπὰ πῆ νι ἄηχανε οἱ στρατιώται νι εβαλήκανε τ'ου ὄμο σου ταῖ  
 γάσσα, τσ' ἐμβαήτσε το μάλι τσ' ἐζωνδανούτσε ἅ ἴάτη τσαι νι ἀνδζε το  
 βασιλόπουλο γουναίκα· τσ' ἐζάτσε ἅ μαρεία τ'ο γάμο τσαι νι ὠράτσε τσ'  
 ἐρωτήτσε τοῖ γαθρέφτα ποία ἐκι ὄμορφο τσαι νι ἐπέτσε 'σαν da νύθη π'  
 ἐνάτ'ε ὄχι ὄμορφο ἐκιού.' τσ' ἐνδούτσε μία τσ' ἐκράε τσ' ἐζάτσε τσ' ἐπεινάτσε  
 τσ' ἐζάτσε τ'ο διάβολε.

KASTANITSA. (*Translation.*)

There was a queen and she was sitting inside a crystal glass ; she was sitting sewing ; she pricked her hand, and blood came out and snow also was falling, and she said : ' My God, give me a daughter so that she may shine as is the snow and that the blood may be red in her face.' She gave birth and a daughter was born, bright as the snow, like the red apple. She did not survive, and died and left the daughter and gave her over to the foster-mother, and the King married and took another wife ; this wife was a magician ; she envied her because she was beautiful ; she envied the girl Pendémorpho and used to go to the mirror. ' My mirror, my mirror, who is beautiful in this land ? ' ' You are beautiful but not so beautiful as Pendémorpho.' She was jealous of her and said to the servants, ' Take her for me and carry her off to a mountain and kill her for me and take out her heart and her eye, and bring it so that I may eat them.' The girl said to them, ' Why should you kill me ? leave me in this mountain.' ' Your step-mother told us to take out your heart and your eyes.' ' Why should you kill me, leave me in this mountain that the wild beasts may eat me.' ' With what heart shall we go to your step-mother because she wants to eat them.' A porcupine came out, and she said, ' Kill the porcupine and take out its heart and take it to my step-mother.' The slaves left the girl in the mountain and went away ; they went to the queen and she asked, ' Have you killed her ? Give me her heart so that I may eat it.' The girl went, found a house and went in and sat down and found the table laid and sat down and ate and went into the bed-room and lay down on the bed and went to sleep. In the evening the dwarfs came ; they said, ' Who has come in here and, in order to eat the food, has lighted the lamp ? ' And they went and found the girl sleeping, and the five dwarfs listened for her to get up lest they might wake her and the girl be frightened. They said to her, ' What do you want here where you have

come?’ The girl said to them, ‘I had a step-mother and she was bad and she sent me with the slaves to the mountain so that they might kill me and they did not kill me and I came over here.’ So they said to her, ‘Look out lest she come.’ She went to the mirror and asked the mirror, ‘Come, tell me now, mirror, who is the fair one in this country?’ ‘You are fair but not so fair as Pendémorpho.’ ‘Why she is alive again; the slaves did not kill her, they deceived me.’ So she got up and put on peasant clothes, and took combs large and small (?) and various other things and went and went and found her. ‘Small combs, large combs’ she kept crying, and Pendémorpho came out at the window; ‘Come to see what you want.’ By misfortune she had not large combs, and she went out at the window, and she said to her: ‘Open to me so that you may take the comb.’ She said to her, ‘I am not opening. Stay at the window,’ she replied to her from the window; the girl took it and combed herself; as soon as she put it in her head she died. She went; the dwarfs came and said, ‘Oh! she has come and the girl has died.’ She was killed and they went to put a shroud on her and found the comb in her head and they took out the comb from her head and the girl came to life. They said to her, ‘We will go to our work and don’t open to her, because she will ask the mirror again and then come back.’ The queen went and asked the mirror again and said to it. ‘My mirror, my mirror, who is beautiful in this country?’ ‘Oh! you are beautiful, but not as beautiful as Pendémorpho.’ ‘Oh!’ she said, ‘She has not died again.’ She took belts and went again and said to her, ‘Come so that we may give you a belt to wear.’ She deceived the girl again and she took the belt and put it on and died. In the evening the dwarfs came again and the dwarfs said, they kept crying, ‘Alas, she has come again and killed her, look!’ They went to take off the belt and the girl came to life again. The queen went to the mirror again and asked, ‘My mirror, my mirror, who is fair in this country?’ ‘You are beautiful but not so beautiful as Pendémorpho.’ She took apples and went and found her again; she went with apples and said to her, ‘Come let me give you an apple,’ and the girl took it and put it in her mouth and died. The dwarfs came and found her dead. They kept crying. They put her in a shroud, placed her in the box and took her. They carried her away to a mountain there where it was. They took her to the mine and did not bury her. Now there passed by the King’s son who was hunting, and he saw her. He said to the dwarfs, ‘Give her to me even though she is dead.’ There

where the soldiers took her they put the box on their shoulder and the apple came out and the girl came to life again, and the king's son took her to wife. And the step-mother came to the marriage and saw her and went and asked the mirror who was beautiful and it said to her 'You are not as fair as she who has become the bride (*lit.* as the bride who has become)' and she smote herself and burst and died and went to the devil.

C. A. SCUTT.



## MODERN GREEK CAROLS IN HONOUR OF SAINT BASIL.

---

UPON the Eve of St. Basil, whose festival, in the Greek Church, falls upon New Year's Day, processions of carol-singers go from house to house making their collections under the pretext of wishing the inmates good fortune for the coming year. That the practice is of very considerable antiquity is shown by the existence of a carol of the Byzantine Age<sup>1</sup> which I have discussed elsewhere.<sup>2</sup> The name *κάλαντα* by which such songs are called is connected with the Latin *kalendae*.<sup>3</sup> The procession, now usually composed of children, carries lanterns and often the paper model of a ship.<sup>4</sup>

Mention must further be made of the mumming plays, which have been discussed by Mr. Wace,<sup>5</sup> since the performers in the two instances draw in part upon a common stock of popular poetical commonplace.<sup>6</sup> It is clear that the tendency to transfer these mumming plays to the period of Carnival is modern and to be accounted for by European and ecclesiastical influences. Originally they too appear to be associated with the period between New Year's Day and the Epiphany rather than with Shrove Tuesday.

It might have been expected that throughout the Christianity of the Nearer East St. Basil would have been uniformly honoured in the popular

<sup>1</sup> *Λαογραφία*, i, p. 564.

<sup>2</sup> 'St. Basil and Julian the Apostate. A Fragment of Legendary History,' *Liverpool Annals*, vii, pp. 89-106.

<sup>3</sup> G. Meyer, *Neugriechische Studien*, iii, p. 23. For the forms with *κολ-* (cf. the Rumanian *colinde*) v. *ib.* ii, p. 33 s.v. *κάλαντα*.

<sup>4</sup> V. Hamilton, *Greek Saints and their Festivals*, pp. 103-104.

<sup>5</sup> 'North Greek Festivals and the Worship of Dionysos,' *B.S.A.* xvi, pp. 232 foll. 'Mumming Plays in the Southern Balkans,' *B.S.A.* xix, pp. 248 foll.

<sup>6</sup> V. below, p. 51.

rite. Such however does not appear to be the case. To Dr. F. C. Conybeare and to Mrs. Wingate of the American Mission at Talas I owe the information that St. Basil carols of the types illustrated below are not known among the Armenians. For Rumanian carols I am under a debt to the learning of Dr. Gaster. He tells me that both upon Christmas Eve and New Year's Eve carol singers make their round. The carols are commonly called 'Songs of the Star' from the lighted lantern in the form of a huge star which is carried in the procession. In addition to these there are carols called '*colinde*,' practically ballads of a religious character, but none refer strictly to St. Basil.<sup>1</sup> Indeed the only examples of the existence of the St. Basil carols outside modern Greek communities, which are known to me, are some fragments of Gypsy carols which the erudition of Dr. John Sampson has quarried from Paspáti's monumental work.<sup>2</sup> Evidently, though corrupt in form, these fragments belong to a carol taken over by the gypsies directly from the Greek, a source to which Dr. Sampson has succeeded in tracing not a few of the secular song fragments quoted by Paspáti.

The examples of modern Greek carols examined below were sent to me by Dr. W. R. Paton and the pretty metrical translations, of which I have been able to give an example for each of the different types, are in every case his work. The Greek MSS. have been collected over a number of years. Some of them are in the writing of Greek schoolmasters or their pupils, some have been contributed by well known modern Greek scholars, notably Professor Hatzidákis of Athens and Mr. Demosthenes Chaviarás of Sými. I have further made use of two small paper books printed for popular consumption. The first (referred to as *Kal.*) is entitled *Τὰ Καλημέρα (κάλανδα) ἤτοι διάφοροι ὕμνοι ἀδόμενοι κατὰ τὰς ἐορτὰς τῶν Χριστουγέννων, τοῦ Ἁγίου Βασιλείου, τῶν Φωτῶν, τοῦ Λαζάρου καὶ εἰς τὴν Σπαύρωσι τοῦ Κυρίου ἡμῶν Ἰησοῦ Χριστοῦ.* The second (referred to as

<sup>1</sup> Of the 'Songs of the Star' Dr. Gaster writes to me, 'Now curiously enough in these songs no reference whatsoever is made to the saint himself, nay not even in the special ceremony which is known as *vasilca*, i.e. the ceremony of St. Basil. The Saint has dropped out altogether and the plant *busuioc* (*basilicum*), which enjoys a very great reputation owing to some legends connecting it with the Passion, has been substituted. A bunch of *busuioc* is used on many occasions and is either offered as a gift or carried about as a protection against all kinds of evil influences. There are other ceremonies connected with the *vasilca*, such as carrying on a platter the roasted pig's head.' The basil plant of course plays an important part in the religious rites and superstitious practices of Modern Greece.

<sup>2</sup> For these fragments *v. pp.* 57 f. below.

*Εις.*) consists of Ἐγκώμι ἀδόμμενα εἰς τὴν Γέννησιν τοῦ Χριστοῦ, εἰς τὸν Ἀγιον Βασίλειον, εἰς τὰ ἅγια Θεοφανεία, εἰς τὴν Ἀνάστασιν τοῦ Λαζάρου καὶ εἰς τὰ πάθη τοῦ Χριστοῦ.

TYPE I.—*The Staff that Budded.*

The first type of carol in honour of St. Basil is that which narrates how he was met on his way to or from school and was made to say his A. B. C. While doing so the staff on which he leaned miraculously put forth leaves and became a tree with birds in its branches.

This is, perhaps, the type of most frequent occurrence.

The following are among the versions already published :—

Passow, Nos. 294, 296, 297, 298, 299. (These are referred to under their numbers. Passow, 294 and the text from Rétimeo *Kal.* p. 11 appear to be identical.)

<sup>1</sup> (a) *Λαογραφία*, ii, p. 684. (Zakynthos.)

(b) *Λαογραφία*, iii, pp. 262–264. (Zakynthos.)

(c) *Δελτίον*, i, p. 643. [Translated Garnett and Stuart Glennie, *Greek Folk Poesy*, i, p. 215.]

(d) Abbott, *Macedonian Folklore*, p. 82; a translation from the text in A. Δ. Γουσιίου, Ἡ κατὰ τὸ Πάγγαιον Χώρα, p. 38.

Among the documents sent to me by Dr. Paton are the following :—

(e) *Ἡγία Ἄννα* in *Ἐυβοία*, communicated by Hatzidákis.

(f) Probably from Andros, communicated by Hatzidákis.

(g) Epirus. MS. copy in the hand of Chaviarás, with reference *Ζωγράφειος Ἀγών*, i, p. 185.

(h) MS. copy similar to (f). Reference to *Δημοτικὴ Ἀνθολογία* (Athens, 1868).

(i) MS. copy of similar character. Reference to *Συλλογὴ τῶν κατὰ τὴν Ἥπειρον δημοτικῶν ἀσμάτων* (Athens, 1866), p. 194.

(j) Kephallenia, printed in *Kal.* p. 10.

<sup>1</sup> For convenience' sake I shall refer to the different versions under these letters. In cases where reference is made to a version belonging to a type other than that under discussion the number of the type will be added. Thus I (a) would refer to the Zakynthos version of *The Staff that Budded*, published in *Λαογραφία*, ii, p. 684.

(*k*) Thessaly, printed in *Kal.* p. 14.

(*l*) Kalávryta, communicated by Hatzidákis. Of this text the following is Dr. Paton's translation:—

Begins the month, begins the year.  
 January again is here.<sup>1</sup>  
 See from Caesarea town<sup>2</sup>  
 Holy Basil coming down.  
 Paper he is holding and  
 Pen and ink-horn in his hand.<sup>3</sup>  
 Now the pen begins to write  
 And the paper reads aright.<sup>4</sup>  
 'Where dost thou come from, Basil, say?  
 From what up-country makest thy way?'  
 'From my home I'm coming straight  
 To the school I go my gate.'<sup>5</sup>  
 'Thou knowest thy letters perfectly?  
 Basil say the A. B. C.'  
 On his staff he leaned as he  
 Stood up to say his A. B. C.

<sup>1</sup> (*i*) begins

Ἄρχημηνιὺν κί' ἀρχηχρονιὺν κί' ἀρχή καλὸς ὁ χρόνος  
 κί' ἀρχή ποῦ μπῆκεν ὁ Χριστὸς στὴ γῆς ἐπεριπάτει  
 ὁ πρῶτος καὶ χαίμετ' ἦταν ὁ ἄ(γ)ιος Βασίλης.  
 Βασίλη μ' πῶθεν ἔρχεσαι; κτλ.

This opening is due to contamination with Type IV, *The Husbandmen*, v. below pp. 42 foll.

<sup>2</sup> In some of the versions Caesarea is corrupted through ignorance into a nonsense word. In (*e*) the saint comes from *Καισαρείτσα*, in (*a*) from *Κριτσαρίτσα*, in (*b*) from *Πιτσαρίτσα*. A familiar parallel to English readers will be the corruption 'Merriling Town' for 'Merry Lincoln' in the ballad of *Hugh of Lincoln*.

<sup>3</sup> The pen and paper are of course essential to the story, a fact which militates against the theory that the 'red mule' of the Gypsy ballad is to be accounted for by the corruption in the Greek original of these words (v. below, p. 58). The other implements of St. Basil vary. In (*h*) he has an eikon, in (*e*) a copy book as well as paper. In other variants he carries a candle and incense, and in one (Passow, No. 294) an eikon, cross, barley bread and a handful of vegetables,

Βασταίν' εἰκόνα καὶ σταυρό, χαρτί καὶ καλαμάρι,  
 βασταίνει κριθῖνο ψωμὶ καὶ μὴ χεριὰ χορτάρια.

More surprising are the bronze shoes and iron eyes of a Thessalian version, Passow, No. 298,

Βαστῆ χαλκῶν ποδήματα καὶ σιδερένια μάτια.

<sup>4</sup> In (*e*) Christ meets the saint and puts the questions to him. 'Christ, who met him in front of the cross roads, "My Basil, whence come you, and whither go you?" "I come from the school, I go to my mother!" "If you come from the school, tell us the A. B. C."' In (*c*) it is three saints who meet him. *τρῆς ἅγιοι τὸν παντῆξαν κ' οἱ τρεῖς τὸν ἔρωτοῦσι*: cf. (*h*) *τρῆς ἅγιοι τὸν ἀπάντησαν σὲ μὴ στυγὴ βουγίτσα*. In IV (*f*) and IV (*e*) (below pp. 47 note 2, 50) the Jews meet the boy and put the question.

<sup>5</sup> (*j*) has here an addition which is fairly common in variant versions, (e.g. (*c*), (*f*), (*h*) and II (*a*), (*b*), and (*c*)). "'Sit down and eat, sit down and drink, sit down and sing a song.'" "My darling mother never taught me songs, she only taught me letters and the Great Psalms." "If you know your letters, tell us the A. B. C."'

And lo! the withered staff about  
 Branches green begin to sprout.  
 On the branches that are springing  
 Partridges a perch are singing,  
 Partridges—not all but some,  
 Some are pigeons. Look! they come  
 Those are pigeons flying away  
 To the fountains cold go they.  
 Water in their claws they bring  
 And cold snow upon their wing  
 To bathe their master dear they bear  
 And to bathe their lady fair.<sup>2</sup>  
 O Lady tall, O Lady fine,  
 With eyebrows of the silken twine,  
 Lady, when on a holiday  
 You dress for church in best array,  
 Then for your face the Sun you don  
 And for your breast the Moon put on,  
 And on your finger gleaming far  
 Is set the lovely Morning Star.  
 We have sung enough my Lady's praise  
 Now for my Lord your voices raise.  
 O Lord and Master, five times o'er  
 Five times again and five times more  
 Feel in your pocket broideréd,  
 Your pocket worked with silver thread,

<sup>1</sup> (h) has

κατέβηκεν ἡ πέρδικα νὰ βρέξη τὸ φτερό της,  
 καὶ βρέχει τὸν ἀφέντη μας τὸν πολυχρονομένον.

With these words the poem ends. (c) has the same image. 'And below at the foot of it (the tree) is a hewn basin and the partridge descends and drinks and goes up again and shakes her wings and sprinkles the master.' (Cf. Type III (b), below, p. 41). The constant appearance of the sprinkling episode suggests a connection with seasonal festivals such as those discussed by Prof. Frazer, *The Magic Art*, i, pp. 272 foll. This is the more probable in view of the frankly agricultural character of Type IV (below, p. 42).

<sup>2</sup> (e) has 'The pigeons fly away and go to the cool springs that they may go and bring health to their lady, that they may bring health to their master. And here is to your health, my master, and happy years to you, and may you live a hundred years, and may you outlive them, and may you grow white as Olympus, like the white pigeon, like the little nightingale which sings in May that summer is here.' Here the carol ends.

The wish ν' ἀσπρίσης σὰν τὸν Ἑλυμπο, σὰν τὸν ἄσπρο περιστέρι is common in the carols and seasonal songs of Northern Greece. Mr. Wace has suggested, and I am inclined to think that he is right, that the original reference in the second half of the line was to Peristéri the mountain not to the bird, *B.S.A.* xix, p. 263. There is no doubt however that in the majority of cases, as quite clearly here, the present day singer interprets it to mean 'pigeon.'

In (a) the episode of the birds ends with a broad hint. 'The birds have gifts and clothes scented with musk, since Christ and the Blessed Virgin and the Saint blessed them.' Or, still more plainly, 'the birds have gifts, the birds have the scent, the birds have clothes too for little fellows who are very poor.'

And if you find piastres there  
 Give them to us and do not spare--  
 Or pounds or silver buttons, give  
 Them all to us, that you may live.

And many happy returns of the day.

The last eighteen lines of the poem represent the praise of the family in its simplest form. In some examples of Type I the more extended form of praises, analogous to those given below in our specimens of the *Husbandmen* Type, are to be met with. Cf. Passow, No. 294, (*a*), (*c*), (*j*). The examination of the various forms of praise addressed to the different members of the household may be postponed (*v.* pp. 53 foll.).

#### TYPE II.—*The Love Song.*

A curious development of the carol of *The Staff that Budded* is its combination with a love song. Between the lines of the carol are inserted lines addressed to the beloved of the singer and rhyming with the corresponding lines of the carol. Partly owing to the elaborate form, carols of this type tend to lose coherence and their structure decays.

The following examples are before me:—

(*a*) The Cyclades, printed in *Enc.* p. 7. Of this text Dr. Paton's metrical rendering is a translation.

(*b*) The Cyclades, printed in *Kal.* p. 9.

(*c*) Andros, MS. communicated by Hatzidákis.

(*d*) MS. book of carols of unknown provenance. It is written in a childish hand, excessively difficult to decipher, and in form the carol is very corrupt.

Judging from this evidence alone it would have seemed as though Type II was a characteristic product of the Cyclades, but Dr. Paton informs me that the *Love Song* construction is not confined to that group of islands but is also used in Smyrna and the Sporades.

Dr. Paton's translation of (*a*) runs as follows:—

#### CAROL FROM THE ISLANDS.

The month is new and new the year,	A slender rosemary is my dear,
Well may ye in the new year fare.	A church with holy bishop's chair.
The holy Basil comes along.	My Lords, you understand the song.
From Caesarea cometh he,	My lady is of high degree,
A scroll he holds, an eikon too,	Sugar candy, crisp and new,
A pen and inkhorn in his hand.	Give some to me, the pretty man.

The pen is writing constantly,  
 The paper all the writing told.  
 'Basil from whence so hurriedly?'  
 'From what up-country, Basil, tell?'  
 'I'm only coming from my home  
 And to the school I'm on my way.'  
 'Sit down and drink, sit down and eat  
 Sit down and sing a ditty jolly.'  
 'I've only learned to read and write  
 I know no song to please your Grace.'  
 'But if you've learned to read and write,  
 Stand up and say your A. B. C.'  
 The staff is green, the staff so sear  
 Green branches from it sprout  
 And on the branches come to sit  
 Partridges and sweetly call.  
 Not partridges alone are here,  
 Little pigeons too I see.  
 And they sprinkled our master,  
 Long may he live!

What did my Fate write down for me?  
 O my lily, white and gold!  
 You do not wish my company.  
 You will not stop to wish me well.  
 Yes, we will talk together, come!  
 But tell me please where I can stay,  
 O if you love me tell me, sweet,  
 And chase away my melancholy,  
 And let me tell you all my plight.  
 O let us sit, dear, face to face.  
 Alack for many a weary night  
 You lay and wept unceasingly.  
 When will she at her door appear?  
 My golden gilly-flower, come out.  
 O! her eyes with love are lit!  
 They never told it you at all.  
 How was it that you found me dear?  
 Sweet dark eyes that look on me.  
 Basil our lord,  
 And renowned throughout the world!

As I have remarked, carols of this type tend to degenerate in the matter of form. The version above translated hangs together until the last four lines; (*δ*) holds out the full course, the concluding verses being as follows:—

Δὲν ἦσαν μόνον πέρδικες	— Καὶ τώρα 'ποῦ μὲ εὔρηκες.
Μόν' καὶ περιστερᾶκια.	— Μαύρα μου γλυκὰ ματάκια.
Κατέβηκεν ἡ πέρδικα,	— Στὰ δίκτυα σου 'μπερδεύθηκα
Νὰ βρέξῃ τὸ φτερό της	— Μὴ θελήσης δ' ἡ σκληρότης
Καὶ βρέχει τὸν ἀφέντη μας	— Νὰ τρώγῃ τὴ νεότη μας
Τὸν πολυχρονεμένον.	— Τῶν δυῶ τῶν πληγωμένων. <sup>1</sup>

<sup>1</sup> They were not only partridges	— And now you have found me,
But little pigeons too.	— My dear little black eyes!
The partridge came down	— I am entangled in your nets. <sup>1</sup>
To wet her wing,	— Do not be willing that hardness of heart
And she sprinkles our master,	— Shall eat our youth,
Long may he live.	— Of us two smitten.

<sup>1</sup> The idea of 'I am entangled in your nets' is suggested to the lover by the mention of the partridge in the corresponding line of the carol. Cf. Type IV *d*, p. 44. 'Nets for the partridges I set and for the leverets snares.' The comparison of his love to a partridge (the Levantine partridge is a less sombre bird than ours) is a commonplace of the Greek poet.

For comparison it is perhaps worth quoting the text of the Andros carol as an example where disintegration has set in :—

Ἄρχημηνιά κι' ἀρχηχροινιά — Ψηλή μου δευδρολιβανιά,  
 Κι' ἀρχή καλός σας χρόνος. — ἐκκλησία μετ' ἅγιος θρόνος.  
 Ἄρχή ποῦ βγήκεν ὁ Χριστός — ἅγιος καὶ πνευματικός  
 Τὴν γῆν να περπατήση, — καὶ νὰ μας καλοκαρδίση.  
 Ἄγιος Βασίλης ἔρχεται — ἄρχοντες τὸ κατέχετε.  
 Ἄπο τὴν Καισαρεία.  
 Βαστᾶ λιβάνι καὶ κερὶ — ζαχαροκάντι ζυμωτή!  
 Χαρτὶ καὶ καλαμάρι.  
 Το καλαμάριν ἔγραφε καὶ τὸ χαρτὶν ὠμίλει  
 Βασίλη πόθεν ἔρχεσαι ; — καὶ δὲν μας καταδέχεσαι,  
 Καὶ πόθεν κατεβαίνεις ; — καὶ δὲν μᾶς συντυχαίνεις.  
 Ἄπο τῆς μάννας μ' ἔρχομαι καὶ στὸ σχολειό μου πάω—  
 δὲν μὲ λές ἴντα νὰ κάμω ;  
 Κάτσε νὰ φᾶς, κάτσε νὰ πιῆς, κάτσε νὰ τραγουδήσης  
 γιὰ νὰ μας καλοκαρδίσης.  
 Ἐγὼ γράμματα μάθαινα, — στὸ διάσκαλό μου πάγαινα,  
 τραγοῦδια δὲν ἤξεύρω.  
 Καὶ σὰν ἤξεύρεις γράμματα ἀκούμπα στὸ ραβδίκι σου  
 Νὰ πῆς τὴν ἄλφα βῆτα — ν' ἄχης τὸν θεὸν βοήθεια.  
 Χλωρὸ ραβδί, ξηρὸ ραβδί — ἄσπρο σταφύλι ράζακι !  
 Χλωρὰ βλαστάρια ἐπέτα — ῥοδοκόκκινη βιολέττα !  
 Ἐπου κάτω ἴστῆς ῥιζούλαις τῆς μιὰ βρύσι κρουσταλλένια  
 Ποῦ κατεβαίναν πέρδικαις κι' ἐβρέχαν τὰ φτερά τους  
 Κι' ἐβρέχαν τὸν ἀφέντη μας — τὸν μπέη τὸν λεβέντη μας  
 Τὸν πολυχρονεμένο — στὸν κόσμον ξακουσμένο.  
 Δὲν ἦσαν μόνον πέρδικαις — γαροφαλαιῖς λεβέντικες  
 Μαζὺ καὶ τρυγουνάκια — μαύρα μου γλυκὰ ματάκια.  
 Σένα σου πρέπει ἀφέντη μου καργιόλα νὰ κοιμᾶσαι  
 Βελούδα νὰ σκεπάζεσαι νὰ μη κρυολογᾶσαι.  
 Καὶ πάλιν ξαναπρέπει σου καρέκλα καρυδένια  
 Γιὰ νὰ κουμπᾶς τὴν μέση σου τὴν μαργαριταρένια.  
 Κι' ἀκόμα ξαναπρέπει σου φλουριά νὰ κοσκινίξης  
 Καὶ τ' ἄπο κοσκινίδια σου σ' ἔμας νὰ μᾶς τὰ δίνης.  
 Πολλὰ παμε τ' ἀφέντη μας, ἄς ποῦμε τῆς κυρᾶς μας.



Κυρὰ ψηλή, κυρὰ λιγνή, κυρὰ καμαροφρύδα,  
 Ποῦχης τὸν Ἕλιον πρόσωπο καὶ το Φεγγάρι στῆθος,  
 Καὶ τοῦ κοράκου τὸ φτερό τῶχεις καμαροφρύδι.  
 Πολλὰ ἴπαμε εἰς τὴν κυρὰν, ἄς ποῦμε καὶ τῆς κόρης.  
 Ἐχεις καὶ κόρη ἔμμορφη που δὲν τὴν ἔχει ὁ Ρήγας,  
 Οὔτε στὴν Πόλιν βρίσκεται οὔτε στὴν Βενετία.  
 Γραμματικὸς τὴν γύρευε πολλὰ προικιὰ γυρεύει,  
 Γυρεύει ἀμπέλια ἀτρύγητα κι' ἀμπέλια τρυγομένα,  
 Γυρεύει καὶ τὸν ταρσανᾶν<sup>1</sup> μὲ ὄλα τὰ καράβια,  
 Γυρεύει καὶ καλοὺς καιροὺς γιὰ νὰ τὰ ταξειδεύη.  
 Πολλὰ παμε τῆς κόρης σας, ἄς ποῦμε τοῦ γιουῦ σας.  
 Ἐχεις καὶ γιουῦ, τὸν καλογιουῦ, καὶ γιουῦ τὸν κανακάρι,  
 Ποῦ νὰ πιάσῃ τὸ χαρτὶ καὶ χύνει τὸ μελάνι  
 Κ' ἐλέρωσε τὰ ρούχα του τὰ χρυσοκεντημένα  
 Ὅπου του τὰ κεντήσανε οἱ τρεῖς Βασιλιουπούλλαις.  
 Ἡ μιὰ ἦτανε τοῦ Πρίγκιπα, κι' ἄλλη τοῦ Βεζύρη,  
 Κι' ἄλλη πιὸ μικροτέρη τοῦ Μέγα Βασιλέως.  
 Ἐχεις καὶ γιουῦ ἴστα γράμματα καὶ γιουῦ εἰς το ψαλτῆρι  
 Νὰ δώσῃ ὁ Θεὸς κι' ἡ Παναγιὰ νὰ βάλῃ πετραχήλι.  
 Πολλὰ παμε κι' ἀπόπαμε, ἄς ποῦμε καὶ τοῦ χρόνου.  
 Τοῦ χρόνου καὶ τ' ἀντίχρονου σ' ἂν τούταις ταῖς ἡμέραις  
 Νὰ εἴμασθε χαρούμενοι καὶ καλοκαρδισμένοι.  
 Στὸ σπητικὸ ποῦ λάχαμε πέτρα νὰ μὴ βραῖσῃ  
 Κι' ὁ νοικοκύρης τοῦ σπητιοῦ χίλια χρόνια νὰ ζήσῃ  
 Καὶ τοῦ χρόνου !

For the present no comment need be made upon the blessings invoked upon the various members of the household. The varieties of the convention are illustrated below, pp. 53 foll.

### TYPE III.—*The Golden Tree.*

(a) Sými. The metrical version given below is a translation by Dr. Paton of a text communicated by Mr. Demosthenes Chaviarás. Michael the Taxiarch is, of course, the Saint *par excellence* for Symioties, in whose island is situated the famous monastery dedicated to his name. Dr.

<sup>1</sup> The Arsenal.

Paton's translation very cleverly follows the original in the inconsistent combination of rhymed and unrhymed verse.

(*b*) Aigina, published in *Λαογραφία*, ii, p. 685.

(*c*) MS. text in pencil by childish hand, uncertain whence.

CAROL FROM SÝMI.

The month begins, the year begins, and may a happy year  
 Begin to us and to the earth that the world's Master trod.  
 And, where he trod, a golden tree upon his footing grew.  
 Golden were all its branches, and of solid gold the stem,  
 And angels and archangels sat upon the little twigs,  
 And Michael the archangel passed the tree and thus he spoke  
 'The Keys of pearl, that Paradise unlock, were given to me  
 That I might enter in and drink the cool fount plenteously,  
 And lay me down and go to sleep under an apple tree,  
 With blossoms falling on me and pomegranates at my feet,  
 And all about my hair the golden roses smelling sweet.  
 Thou hast thy son, thine only son, the darling of thy soul,  
 Thou combest him and washest him and sendest him to school.  
 The master took him to begin his lessons, but the taper  
 Dropped from his hand, when they begun, and burnt up all the paper  
 And spoilt his clothes, embroidered in gold by three princesses.  
 The eldest wrought her love-longing, the next her heart's distress,  
 But the third and youngest broidered there her face's loveliness.  
 The eldest was the prince's, the second the vizir's,  
 But she the third and youngest was the chosen of the king.'  
 Kill us your cock, good wife, and gie's your hen for this our labour,  
 And gie's the silver, for we're fain to go on to your neighbour.  
 But in this house to which we came may no stone ever crack  
 And may the good-man o' the house live long and never lack.

Of the other two versions in which the Tree stands alone as the central incident, (*b*) begins with the greeting of Christ to the husbandmen (cf. Type IV, below), but continues:—

'And there where Christ stood, appeared a little cypress of gold.  
 In its middle it had the Cross and on its top the Gospel,  
 And on its twigs Angels and Archangels,  
 And beneath, at its root, a crystal spring  
 That the partridge may come down to wet her wings  
 And sprinkle our master,—long may he live!'

It then continues with praises of the family and a petition for alms.

(*c*) begins:—

Ἦνοιξε πόρτα τοῦ σπητιοῦ καὶ Ἑλληνικὸ παλάτι  
 Ν' ἀκούσετε παραβολῆς καὶ κοιμηθῆτε πάλιν.  
 Ἄρχῃ μηνιᾶ καὶ ἀρχῇ χρονιᾶ καὶ ἀρχῇ τοῦ Ἰαναρῖου  
 Κε' ἀρχῇ ποῦ περιπάτησε χρυσὴ μηλίτσα βγῆκε

Καὶ μὲς τὰ φύλα τῆς μηλεᾶς ἐν μῆλο χρυσομένο  
 ὅποιος τὸ παραχρῦσωσε ὁ Ἥλιος τῆς ἡμέρας,  
 τὸ Φεγγαράκι τῆς νυκτός, τὸ Ἄστρον τῆς ἑσπέρας.<sup>1</sup>

Then follow the wakening of the master and the customary praises.

TYPE IV.—*The Husbandmen.*

The longest and most elaborate type of carol in honour of St. Basil has for its central incident the blessing of the saint's oxen by Christ. Quite clearly the song is tinged with the feeling which lies behind the *Narrative Charm* so familiar throughout Europe. The *Narrative Charm* aims at producing desired results by telling how they were miraculously brought about in an analogous case. For instance, to cure headache, a narrative may be recited which tells how Christ met Headache on his way to torture a victim and forbade his purpose. Similarly, the narrative of the blessing of St. Basil and the great crop which he harvested is intended to secure agricultural prosperity to those for whose benefit it is sung. The season of the New Year, the mumming festivals to which allusion has been made above, suggestive details in the carols themselves, e.g. the sprinkling of the master by the partridges, all point in the same direction. We may remember, too, that the boys, who go round with sticks knocking up the householders of Macedonia on New Year's Day, salute their benefactors with the greeting, 'Health, joy, and St. Basil give you lots of wheat and lots of barley and lots of children.'<sup>2</sup> With this may be compared the lines added to a Cretan carol (IV, b) which are sung by the waits on the following day, i.e. January 1st:—

'A good beginning of the month to you!  
 May your kids and lambs be female  
 And your children boys.'<sup>3</sup>

<sup>1</sup> 'Open the door of the house and the Greek palace  
 That you may hear a parable and go to sleep again.  
 The beginning of the month, the beginning of the year, the beginning of January  
 And the beginning—where he stepped, a golden apple tree sprang  
 And midst the leaves of the apple tree a golden apple  
 Which the Sun by day made golden  
 And the Moon by night and the Star in the evening.'

<sup>2</sup> Γεῖα, χαρά, κῆ ὁ Ἄϊ Βασίλης πολλὰ σιτάρια, πολλὰ κριθάρια, πολλὰ πηδοῦδια. Abbott, *Macedonian Folklore*, p. 80.

<sup>3</sup> 'Die Gratulation am folgenden Tage':

Καλή σας ἀρχιμενιά,  
 τὰ βίφια καὶ τ' ἀρνιά σας θηλυκά  
 καὶ τὰ κοπέλια σας ἄσερνικά.

A carol which has already been published<sup>1</sup> brings out this aspect of these popular poems. It is in the difficult Cappadocian dialect of Misti, though my own impression that the text in some way differs from the conversational language of the village is confirmed by Mr. Dawkins. He suggests that the non-dialectic character of the text is witness to its traditional antiquity, and in part its difficulty may be due to its survival on the lips of persons uncertain as to the exact meaning of the words.

Its form is peculiar, for it is divided into verses of two lines followed by the chorus:—

‘The birds cry, the nightingales sing,  
St. Basil mine, good and blessed.’<sup>2</sup>

The matter of the verses is familiar. They enumerate the different parts of St. Basil’s apparatus, his fine yoke of oxen, his ploughshare cast in silver, the pearl studs of the yoke, etc. (Cf. IV (A), l. 15.)

The last verse is worthy to be placed beside the greeting of the little boys in Macedonia.

We sowed one measure, we reaped a thousand measures,  
May we eat and drink for all time as in these days.

*Chorus.* Cakes, biscuits, bottles, drinks,  
St. Basil mine, good and blessed.<sup>3</sup>

<sup>1</sup> Quoted in *Λαογραφία*, i, p. 143 from *Φόρμιγξ*, December, 1908, p. 8, where it was first published by N. Βασιλόπουλος.

<sup>2</sup>

τὰ πουλιὰ λαλοῦντα, τὰ χερόνια κρᾶζουν  
‘Αη Βασίλη μου, καλὸ κ’ εὐλογημένο.

The notes of the collector give *χερόνια* = *ἀηδόνια*. It may mean ‘nightingales’ though hardly as he suggests because it is a dialect form of *χελιθόνια*, ‘swallows.’ It will be seen that I have transposed two lines in the text but the emendation is quite certain. It is borne out not merely by parallel passages and by the demands of the sense, but also by the evidence of the last verse of the text as given.

A carol, which does not fall under any of the types discussed, has been recorded from Phárasa, a village in the Anti-Taurus. Similar in form to the Misti carol, it consists of distichs with a chorus of religious ejaculations after each. The text is very obscure: the song apparently is accompanied by a dance. Whether it represents the disintegrated form of a seasonal festival or has suffered from contamination with some singing game it is difficult without further evidence to determine. Γ. Δ. Παχτικός, *260 Δημῶδη Ἑλληνικά Ἕθνη*, pp. 17-19.

<sup>3</sup>

ἐσπείραμ’ ἓνα μέτρος, σοικῶσαμ’ χίλια μέτρα  
ἕς φάσμετε (?) κί’ ἕς πιόμαστε χροῦς ἴς αὐτὰ τὰ μέραις,  
(ἐπφδδς) Κόσκινα, καρλόπα, χάροπα, κρασόπα  
‘Αη Βασίλη μου, καλὸ κ’ εὐλογημένο.

*φάσμετε* is almost certainly a misprint for *φάμεστε*. The words in line 3 are obscure. Βασιλόπουλος gives *κόσκινα* = *βασιλοπιτταί* (for these New Year cakes see Abbott, *op. cit.* pp. 77 foll.); *καρλόπα* = *κουλλούρια*; *χάροπα* = *μποτίλια*; *κρασόπα* = *κρασοπότηριον*. The last is certainly wrong. -όπα is a diminutive termination and *κρασόπα* = *κρασάκια*.

Of the more normal type of the *Husbandmen* carol, several fine examples have been sent to Dr. Paton by Hatzidákis.

For published versions :

- (a) Rétimo, in *Kal.* p. 11.
- (b) Jeannaraki, *Ἕλισματα Κρητικά*, No. 367, p. 249.
- (c) Δελέκος, *Ἐπιδόρπιον* (Athens, 1888), A', p. 10.

I have the following MSS. texts before me :—

- (d) Probably Crete. Translated below by Dr. Paton.
- (e) Kythera. Unfortunately the MS. has suffered considerably from the ravages of the ink-loving insects of the Levant.
- (f) Crete.
- (g) Possibly Cretan, but labelled as uncertain.

The carol seems to be popular in Crete and the S. Peloponnese, whence Δελέκος' version appears to have been derived.

#### THE HUSBANDMEN.

Let us go in to-night and bid good-evening to the couple,  
The pretty pencilled partridge and the cypress tall and supple.  
And why? Because in every place beneath the stars of heaven  
To-night a friend goes in to greet his friend and bid good even.

- 5 The month is new, the year is new, a new and happy year.  
The calends have come round again and January 's here.  
When Christ the Lord at first came out upon the earth to walk,  
Across the fields He went to look and to the ploughmen talk.  
And Holy Basil was the first He saw a-ploughing there.
- 10 'Hail! my Lord Bishop Basil, here you have a pretty pair.'  
A pretty pair, my master, yea, and blessed above the best,  
For Christ Himself with his right hand uplifted both hath blessed.  
He blessed the dun, the crumple-horned likewise He blessed.' 'Thy yoke,  
Basil, is of the laurel tree, thy plough of holly-oak,
- 15 The pins above the laurel yoke are set with pearls around  
And on the handle of thy goad a sprig of basil 's bound.'  
He turned him round again to ask, 'And, Basil, I would know  
How many bushels thereabout doth my Lord Bishop sow?'  
'Twelve bushels of the wheat I sowed—barley fifteen in all,
- 20 The vetch and peas were nine apiece—and early home to stall.  
But to be sure, down near the beach, near where the salt seas break,  
Of wheat I sowed a bushel and of barley but a peck ;  
But there the partridges came down, likewise the little hares.  
Nets for the partridges I set and for the leverets snares.

25 Never a leveret could I catch, never a partridge see ;  
 But I reaped and thrashed the nibbled ears that they had left for me  
 A thousand bushels full I got, a thousand yet to tell,  
 But Christ the Lord was passing and I could not count it well.  
 His paper is the firmament, the sea His ink, and now  
 30 The Lord hath rested here to watch the oxen and the plough.  
 And on the spot where stood the Lord a golden tree took root,  
 A golden sapling cypress grew where He had set His foot.  
 - - - - - the stem is silver all,  
 And in the twigs a partridge sits, and to his mates doth call :  
 35 Call on, call on, my bonny bird, and sing until nightfall.

But we must go and rest to-night beside my master's door ;  
 His door is of the crystal clear, of marble is his floor,  
 His windows are of carved wood, so curiously wrought,  
 So cleverly they're fashioned, from Venice they are brought.  
 40 And here their boy, the lily-white, the darling of their soul,  
 Is kept. They combed him, washed him, and sent him to the school.  
 The teacher took him to begin his lessons, but the taper  
 Fell from his hands when they began, and burnt up all the paper,  
 And burnt his clothes, the pretty clothes, and burnt his primer new ;  
 45 He had a satchel thirty-shuttled,<sup>1</sup> that was burnt up too,  
 The satchel broidered cunningly by the princesses three,  
 Three ladies noble and beautiful, damsels of high degree.  
 The one her longing broidered there, the next her heart's distress,  
 But the third and youngest broidered there her face's loveliness.  
 50 The master with his golden tawse he whipped him very sore,  
 The mistress took her scented bunch of musk and whipped him more.  
 The grief of it got hold of him ; he goes from street to street,  
 And through the long bazaar he walks and bitterly doth greet.  
 ' Where goes the musk-whipped boy ? ' cries out each merchant from his place.  
 55 The merchants' boys come out and call : ' Where goes he in disgrace ? '  
 ' The teacher whipped me : he was right, although he made me smart ;  
 The lady-teacher whipped me too ; she whipped with all her heart.'  
 Now of your son we've told enough ; we'll tell my lord about.  
 Where does my master sleep ? for we would go to seek him out.  
 60 He lies among the musk-leaves upon the scented heap ;  
 With the musk and with the roses they have covered him to sleep.  
 ' But who will in and who will out to wake my lord the e'en ? '  
 ' O give me apples twelve and give me quinces too fifteen,  
 And I will in and out to bid my lord arise betime.'  
 65 ' Rise up, my lord, rise up to go to church and hear the chime,  
 To hear the deep bells of the Franks, the loud Greek bells to hear.  
 In every belfry merrily they're ringing in the year.

---

<sup>1</sup> This points to the satchel being made of a stuff with a pattern of many colours which seems to be embroidered, but is in fact produced in the loom as the stuff itself is being woven, each colour of the pattern being carried by a small shuttle subsidiary to the main shuttle which carries the warp. The ground is generally white. Such stuff is, or was, commonly made in Crete for carpets, coverlets, and satchels.—R. M. D.

But you, my lord, deserve to furnish out a galleon gay,  
 And all the tackle of your ship with gold to overlay,  
 70 And you deserve a chair to sit and measure out your wealth.  
 With one hand measure and with one give us to drink your health.  
 The hindmost of the hare is yours and of the ham the slice  
 You like, and of the partridge just the piece you think is nice.

Now of my lord we've sung enough ; we'll sing my lady's praise.  
 75 Oh ! pearly is my lady's neck ; her face is even so  
 As the full moon, like glass it is, and like the frozen snow.  
 My lady, you should be a church with arches two times nine ;  
 On every step a light, on every two a torch to shine,  
 A golden drinking-fountain set on every three or four,  
 80 That all God's creatures who are athirst may drink and thirst no more,  
 That all the travellers that pass may stop and drink at will  
 The water cold, and praise the Lord when they have drunk their fill.

Now of my lady we have sung ; we'll of her daughter tell.  
 You have a daughter fair the ladies of romance beyond ;  
 85 In Venice and in Istambul no fairer shall be found.  
 She is so fair a learned clerk I know to wed her is yearning.  
 Alack ! a heavy dower he asks in spite of all his learning :  
 For sheep he asks the stars, and for his grazing-place the sky ;  
 He asks the sea and all the ships that in its havens lie ;  
 90 He asks for old King Boreas to sail them famously.

Now of your daughter we have sung ; we'll sing to the serving-lass.  
 Light ye the candle, little lass, and up and down the stair,  
 And sit ye down and think ye well what ye can find for us there.  
 A bit of duck or sausage, or of chicken wing a bittie,  
 95 And from your little kistie a little pair, my pretty.  
 And from the good-man's purse ye'll get a penny, never fear ye.  
 And from the tappit black hen an eggie give us, deary ;  
 And if it's from the red hen, we'll take it if they're a pairie.  
 And from the barrel tap, dear, for a bumper we will ask ye,  
 100 And give us a nipperkin of oil out of your little caskie.  
 And if it's corn we'll take it, dear, because we won't refuse them,  
 - - - - - we'll share them and we'll use them.  
 And ye'll crack us a few walnuts, and throw them on the tray, dear ;  
 And sweet wine give the lads to drink, for it is New Year's Day, dear.  
 105 What ! still, my dear, you're doubtful ? Is there nothing you can find us ?  
 Unbar the door and give us a drop ; then bar the door behind us.  
 Aye, if it's with your will, dear, my little pigeon white,  
 Unbar the door and let us rise and bid ye all good-night.  
 And good-bye.

[They get up to go, but are rewarded and treated. Then they continue :]

110 A happy chance it was we came here where so well they pay.  
 May what they keep and what they give go with good luck alway.  
 And if they have a girl-child, may blessings on her rain,  
 May her fate be ever golden ; may she wed the prince of Spain.

- And if they have a man-child, may he go forth to ride  
 115 And lose his seat and scatter the gold-pieces far and wide.  
 The lords shall run to gather them to make them into rings ;  
 They'll take and make them nailpickers of gold,—the wee lordlings.  
 As many stars are in the sky and leaves in forest shady,  
 So many be the cambric shifts you shall wear out, my lady.  
 120 As many stars are in the sky and blades in the green sward,  
 So many be the cambric shirts you shall wear out, my lord.'

The MS. concludes with two lines which Dr. Paton has not translated. They are found also in (*b*).

*γράμματα εἰκοσιτέσσερα ἔχει ἡ ἀλφαβῆτα  
 κί ὅσοι κί ἂν ἀπομένετε ἔχετε καληνύκτα.<sup>1</sup>*

Of the other versions I will note some of the variations in detail, and give one complete Greek text.

(*f*) opens with the blessing of the oxen and the miraculous harvest. I quote from l. 13 onwards:—

*Κί ἐθήρισα κί ἀλώνεψα κ' ἔκαμα χίλια μόδια  
 κί ἄπο σκυβαλίδια του δὲν εἶχα ποῦ τὰ βάλω.  
 Καὶ παίρνω τὸ στρατί στρατί, τὸ νιὸ τὸ μονοπάτι  
 νὰ πᾶ νὰ βρῶ τὸν πιθαρά, πιθάρια νὰ μου κάμη.  
 Ὕστη στρατά μ' ἀπαντήσανε οἱ σκύλλοι οἱ Ἀγουδαῖοι  
 ποῦ καστιγάραν τὸν Χριστὸ κί ἀποῦ τὸν ἐσταυρώσαν.  
 Κί ἐκεῖ μ' ἐκαστιγάρασι νὰ τῶν εἰπῶ τραγούδια.  
 — Μὰ μάνα δὲν με μάθαινε τραγούδια γιὰ νὰ λέω  
 Μὰ μάθαινέ με γράμματα ἴστην ἐκκλησιά νὰ πηγαίνω —  
 — Καὶ σὰν κατέχεις γράμματα πέ μας τὸ μίθημά σου —  
 Καὶ τὸ ραβδί του ἀκούμπησε νὰ πῆ τὸ μίθημά του,  
 καὶ τὸ ραβδί ἦτονε ξερό, χλωρὰ βλαστάρια βγάινει,  
 κί ἀπάνω ἴς τοὺς χλωροὺς βλαστοὺς ἀετοφωλεὰ κτισμένη,  
 κί ἀπάνω ἴς τὴν ἀετοφωλεὰ χώρα ξετελειωμένη.<sup>2</sup>*

<sup>1</sup> Twenty-four letters has the alphabet  
 And a good night to all of you who remain.

<sup>2</sup> And I reaped and I threshed and I made a thousand bushels  
 And the gleanings of it, I had not where to put them.  
 And I take the road, the road, the new (?) path  
 To go to find the potter that he may make me pots.  
 On the road there met me the dogs the Jews  
 Who scourged Christ and afterwards crucified Him.  
 And there they scourged me to make me sing them songs.  
 'My mother did not teach me songs to sing



Then follow the waking of the master and praise of the mistress and maid-servant.

The printed version (*a*) has the blessing of the oxen, the magical crop, and the golden tree. This is immediately followed by the burning of the clothes made by the princesses, which passes into the episode of the alphabet:—

Κι' ὁ δάσκαλός του τὸ 'δειρε μ' ἓνα χρυσὸ βιτσάλι,  
Πέρναι τὸ ἢ παραπόμεση στὴ γύτσα, γύτσα πάει,  
Στὴν στράτα τ' ἀπαντέχρουνε τρεῖς ἄρχοντες καὶ τρῶνε.  
— Κάτσε νὰ φῆς, κ.τ.λ.

(*g*) opens with the blessing and the magical crop, which concludes with lines 17 and 18.

' And of the winnowings fifteen hundred bushels,  
But I did not winnow it well, for Christ was passing by.<sup>1</sup>  
And there where Christ stood, a golden tree put forth,<sup>2</sup>  
And in its midst it had the cross, and on its top the spring,  
And on its topmost twigs a partridge calls.  
It was calling, it was calling.

There follow the son who is beaten at school and spoils the clothes brodered by the three princesses, the praise of mistress and maid-servant, and epilogue of gratitude.

The text from Kythera may be given in full. It will be noted that some of its obscurities arise from the injudicious combination of conventional commonplaces of Greek poetry.

But she taught me letters that I may go to the church.  
' And if you understand letters, tell us your lesson.'  
And he leaned on his staff to say his lesson,  
And the rod was withered, it puts forth green twigs  
And above upon its green twigs is built an eagle's nest  
And above upon the eagle's nest, a complete village (?).

<sup>1</sup> Μὰ δὲν τὸ καλολίχνεσα γιὰ τ' ὁ Χριστὸς ἐπέρα.  
(*d*) reads μὰ δὲν τὰ καλομέτρησα, (*f*) καὶ ἄλλα δὲν ἐμέτρησα.

<sup>2</sup> (*d*) reads here

Κι' ἐκεῖ ποῦ στάθηκε ὁ Χριστὸς χρυσὸ δένδριν ἐβγήκε  
Κι' ἐκεῖ ποῦ 'παραστάθηκεν χρυσὸ κυπαρισσάκι.  
'Σ τὴ βίτσα γράφει Τζέτζεβρο κι' δλάργυρη ἢ κορφὴ του  
κι' ἐς τὰ παρακλωνάρια του πέρδικα κακαρίζει,  
κακάριζε, κακάριζε κι' ἐν κελαϊδῆς κελαϊδε.

I cannot understand 'At its root is the writing, Tzétzebro,' and it is clear from the omission in the translation given above that a solution has failed Dr. Paton.

[Ἄρχημηνιά] καὶ ἀρχιχροιά κ' ἀρχὴ τοῦ Γεναρίου  
 κ' ἅγιος Βασίλης ἔρχεται ἀπὸ τὴν Κεσαρεία,  
 βαστᾶ τὸν Οὐρανὸ χαρτί, τὴ θάλασσα μελάνι  
 τὴν ἄμμο τὴν ἀμέτρητη πένα καὶ καλαμάρι<sup>1</sup>  
 κ' ὁ ἄρχος μὲ τὴν ἀρχόντισσα μιὰ σκάλα ἀνεβαίνουν.  
 Πᾶσα σκαλι τὴν ἐρωτᾶ, πᾶσα σκαλι τῆς λέγει·  
 — κερὰ δὲν εἶσαι ῥοδινη, κερὰ δὲν εἶσαι ξιάσπρη. —<sup>2</sup>  
 — σὰν θέλῃς νᾶμαι ῥοδινη, σὰν θέλῃς νᾶμαι ξιάσπρη,  
 σύρε στὴν Ἀνδριανούπολην κ' ἄντε στὸ Σαλονίκη,  
 νὰ μ' ἀγοράσῃς κίνουπα κ' ὀλόχρυσο ζωνάρι,  
 καὶ τότε θᾶμαι ῥοδινη καὶ τότε θᾶμαι ξιάσπρη.  
 καὶ ἐτσίνησε ὁ Νιούτσικος νὰ πάη νὰ κυνηγήσῃ,  
 στὴ στράτα ὁποῦ πήγαινε, στὴ στράτα ὁποῦ πηγαινέι,  
 βρίσκει παιδιὰ καὶ παίζανε καὶ ρίχναν τὸ λιθάρι.  
 βάνει ἢ μάνα του λίτρα κ' ἢ ἀδελφή του λίτρα  
 καὶ ἢ ἑξαδέλφη του λίτρα νὰ πλέξουν τὸ γαϊτάμι.  
 σταῖς οὐρανοῦς τὸ διάστησαν, σταῖς κάμπους τὸ τυλίξαν  
 καὶ εἰς τὸ περιπάτημα τὸ ἐπεριπατήσαν.<sup>3</sup>  
 Πύργος ἐθεμελιώθηκε μὰ λίγο σκεπασμένος  
 καὶ μέσα κόρη κάθεται καὶ τὸ φιλί ζυγιάζει  
 ζυγιάζει καμπανίζει το καὶ μ' ἰρμιδιά τὸ δένει,  
 τοῦ πλούσιου δίνει τὸ πολὺ καὶ τοῦ φτωχοῦ τὸ λίγο  
 καὶ ἐμένα τοῦ μυριάκαλο οὔτε πολὺ οὔτε λίγο.  
 Ἄφέντ', ἀφέντ', ὀλάφεντη, πέντες φορὲς ἀφέντη,  
 πέντε κρατοῦν τὸν Μαῦρο σου<sup>4</sup> κ' ὀχτῶ τὸ χαλινάρι  
 καὶ δεκοχτῶ περικαλοῦν ἀφέντη καὶ καβύλα.  
 κ' ὅπου πατήσῃ ὁ Μαῦρος σου πηγιάδια φανερόνει,

<sup>1</sup> The same tag is used in IV b, l. 29. It appears more properly to belong to a love song. Cf. Passow, No. 303.

γραμματικέ, γραμματικέ, γραμματικέ καὶ ψάλτη,  
 τὸν Οὐρανὸ ἔχεις χαρτί, τὴν θάλασσα μελάνι,  
 κ' ἂν ξηγραφες, κ' ἂν ξέγραφες τὴν δόλια τὴν ἀγάπη.

<sup>2</sup> Cf. Abbott, *op. cit.*, p. 91.

Ἄ Κόρη μ', δὲν εἶσαι ῥοδινη, κόρη μ', δὲν εἶσαι ἄσπρη.  
 Ἄ Σὰν θέλῃς νᾶμαι ῥοδινη, σὰν θέλῃς νᾶμαι ἄσπρη  
 Σύρε 's τὴν Ἀντριανούπολι, σύρε 's τὴ Σαλονίκη,  
 Κὴ ἀγόρασέ μου ἑξάπλατο σερβιώτικο ζουνάρι,  
 Νὰ σειῶμαι, νὰ λυγίζωμαι, νὰ φαίνωται τὰ κάλλη.'

<sup>3</sup> Cf. below p. 54.

<sup>4</sup> This is the black charger on which the hero of Greek romantic poetry habitually caracoles.

- - - - προπήγαδα κι' αὐλαὶς μαρμαρομέναις,  
 ἐδῶ σε τούταις ταῖς αὐλαῖς ταῖς μαρμαροστρωμέναις  
 ἐδῶ κοιμᾶται ἀφέντης μας νὰ πᾶς νὰ τὸν ξυπνήσης.  
 — Φέρτε μου μῆλα δώδεκα, κυδόνια δέκα τρία  
 ἴσως καὶ τὸν ξυπνήσουνι, πλέλκε μου (?) τοῦτο ποῦναι. —  
 Ἄκου, ἀφέντη, κάθησε στὴ ἀργυρὴ σου τσέπη,  
 ἂν εὔρης γρόσι δό μας τό, φλουρί μὴν τὸ λυπᾶσαι  
 κι' ἂν εὔρης καὶ μισόγροσο τὸ θέλουμε κι' ἐκεῖνο.  
 Πολλὰ 'παμε τ' ἀφέντη μας, νὰ ποῦμε τῆς κερᾶς μας  
 — [κερὰ ποῦ] βάνεις τὸν Ἥλιον πρόσωπον καὶ τὸ φεγγάρι στῆθος,  
 καὶ τοῦ κοράκου τὸ φθερὸ γιὰ καμαρόφρυδό σου,  
 τὴν ὄχεντρα τὴν πλουμιστὴ κορδέλλα τῶν μαλλιῶν σου.<sup>1</sup>  
 ἐκεῖ ἐβγήκε ὁ Χριστὸς στὴ γῆ κι' ἐπεριπάτει  
 καὶ βγήκε καὶ χαιρέτισε ὅλους τοὺς ζοβγολάταις,  
 ὁ πρῶτος καὶ χαιρέτισε ἦτο Ἅγιος Βασίλης.  
 — γιὰ σου, Βασίλη δέσποτα, καλὸ ζευγάρι κάνεις. —  
 — καλὸ, ἀφέντη μου Χριστέ, καλὸ καὶ βλογημένο,  
 ἢ χάρι σου τὸ βλόγησε μὲ τὸ δεξί σου χέρι  
 μὲ τὴ δεξιᾶ, μὲ τὴ ζερβιά, μὲ τὴ μαλαματένια  
 — πές μου, νὰ ζήσης, Βασιλιά, πόσα βουδάκια ζέβεις ; —  
 — ζέβω τὸ μαῦρο καὶ τὸ λαγάρδ καὶ τὸ στεφανοκέρι. —  
 — πές μου, νὰ ζήσης, Βασιλιά, πόσα μουζούρια σπέρνεις ; —  
 — σπέρνω σμιγάδι δώδεκα, κριθάρι δέκα τρία,  
 κουκιὰ καὶ φάβα δεκοχτῶ κι' ἀπονωρίς στὸ σταῦλο. —  
 — πές μου, νὰ ζήσης, Βασιλιά, πόσα μουζούρια μπάζεις ; —  
 — κουκιὰ καὶ φάβα ἔσπειρα κάτω στὸ σταυροδρόμι,  
 καὶ μου τὸ λαγουδεύτησαν λαγούδια καὶ περδίκια,  
 καὶ εἰς τ' ἀπολαγουδέσματα ἔκανα χίλια μόδια,  
 κι' εἰς τ' ἀποπερδικίσματα χίλια καὶ πεντακόσια,  
 καὶ εἰς τὰ στερνὰ σεμπάσματα δὲν ἔχω που τὰ βάλω —  
 τὸ φόρο, φόρο περπατεῖ, στὸ σπήτι του πηγαίνει  
 κι' ἐκεῖ τὸν ἀπαντήσανε, οἱ σκύλλοι, οἱ Ἰουδαῖοι,  
 - - - οἱ παράνομοι καὶ τὰ τυφλὰ κουλούκια.<sup>2</sup>  
 — Βασίλη, πῶθεν ἔρχεσαι ; Βασίλη που πηγαίνεις ; —  
 — 'πο τὸ σχολεῖο ἔρχομαι, στὸ σπήτι μου πηγαίνω. —

<sup>1</sup> 'The broidered viper for the ribbon of your hair.'

<sup>2</sup> Clearly there is a lacuna at the beginning of the line. *κουλούκια* = puppies.

— ἐδὰ σὰν ξέρεις γράμματα, πές μας ἓνα τραγοῦδι. —  
 — ἐμένα οἱ δασκάλοι μου τραγοῦδια δὲν μὲ μάθαν,  
 μόνο μὲ μάθαν γράμματα καὶ τὸ χρυσὸ βαγγέλιο. —  
 — ἐδὰ σὰν ξέρεις γράμματα πές μας τὴν ἀλφαβῆτα —  
 καὶ τὸ ραβδί τ' ἀκούμπησε νὰ πῆ τ' ἀλφαβητάρι,  
 καὶ τὸ ραβδί του ἦτανε ξερό, χλωραῖς βλασταῖς ἐπέτα  
 καὶ πάνω σταῖς χλωραῖς βλασταῖς περδίκια κελαδοῦσαν.  
 ὄχι πούλακια μοναχά, μόνο καὶ χελιδόνια,  
 δὲν ἐκελάδουν σὰν πουλιὰ, σὰν κελαῖδοῦν τὰ ἀηδόνια,  
 μόνο κελάδουν κ' ἔλεγαν μ' ἀνθρωπινὴ λαλίτσα.  
 πρέπει σου σένα, ἴφεντη μου, χρυσὴ πένα στ' αὐτί σου,  
 νὰ σε ξεπερετίζουνε οἱ μεγαλήτεροί σου.  
 πρέπει σου σένα, ἴφεντη μου, κορώνα στὸ κεφάλι  
 νὰ σε ξεπερετίζουνε ὅλοι μικροὶ μεγάλοι.  
 πρέπει σου σένα, ἴφεντη μου, νὰ τρῶς κουλούρ' ἀφράτη,  
 τῆς κιτρολεῖμουιᾶς ἀνθὸ νὰ τρίβεσαι σαλάτα.  
 πρέπει σου σένα, ἴφεντη μου, καράβι ναρματώσης  
 κ' εἰς στὴ Κωνσταντινούπολι μονουχτήης νὰ σώσης.

PRELUDES, CONCLUSIONS, AND PRAISES.

Examples have been given of the various types of carol; it remains to say something of the introductions, conclusions, and praises addressed to the various members of the family. These are common to all the types of carol, and are shared also by the actors in the mumming plays discussed by Mr. Wace.

(1) *Preludes and conclusions* :—

Some carols have a few lines of introduction before the opening line of the carol itself, which is regularly

ἀρχὴ μηνιᾶ κι' ἀρχὴ χρονιᾶ καὶ ἀρχὴ τοῦ Ἰαναρίου.

An example is III (c).<sup>1</sup> Similarly I (b) begins

εἶναι μὲ τὸν ὀρισμό σας ἔδωπα ὄξω νὰ καθήσω  
 καὶ νὰ σᾶς καλησπερίσω κι' ἄξια λόγια νὰ σᾶς πῶ.  
 τ' ὑποβραδὺς ποῦ ἐσμίξαμα ἢ συντροφιά ποῦ μένει,  
 νὰ τραγουδήσουμε ἤρθαμε τὸ χρόνο ποῦ μὰς μπαίνει.

<sup>1</sup> p. 41.

I fear that these are also fair examples of the literary merits of these introductions.

It is usual for the carol singers to conclude their song with good wishes on receiving their guerdon. *καὶ εἰς ἔτη πολλά*, literally 'and for many years,' is the phrase habitually used in name-day congratulations, and exactly corresponds to our birthday wish of 'many happy returns of the day.' Often the thanks are more elaborate.

A frequent formula is:—

*ἔδῶ ποῦ τραγουδήσαμε, πέτρα νὰ μὴ ραγίσῃ,  
καὶ ὁ νοικοκύρης τοῦ σπιτιοῦ χίλια χρόνια νὰ ζήσῃ,  
ἔχι ὁ νοικοκύρης μοναχά, μὰ κ' ἔλη ἡ φαμελιά του.*

'Here where we have sung may no stone ever crack,  
And may the master of the house live a thousand years.  
Not the master of the house only, but also all his household.'

This formula occurs in III (*α*).<sup>1</sup> A note of Dr. Paton's remarks 'may no stone ever crack' is a phrase equivalent to 'may there be no illness in the house.' Other examples occur in I (*α*), III (*ε*), Passow, 301, 294. In Passow, 304, the blessing is adapted to the seafaring profession of the serenaded:—

*ἔδῶ ποῦ τραγουδήσαμε, καρφὶ νὰ μὴ ραγίσῃ  
κι' ὁ καπετάνος καραβιοῦ πολλοὺς χρόνους νὰ ζήσῃ.*

I (*α*) has in addition the concluding doggerel:—

*καὶ τοῦ χρόνου κ' ἔχετε γειά  
δῶσε μάς τε καὶ τὸ παρὰ  
οὔρα, οὔρα, οὔρααα.*

'And may you have health through the year  
And give us the copper,  
Hurrah, hurrah, hurra-a-a-h!'

The cheer is, perhaps, a relic of the British occupation of the Ionian Islands.

When the minstrels are unrewarded they are apt similarly to vent their abuse in doggerel:—

'You deserve, my master, a wallet and a beggar's crutch  
That the dogs may tear you in pieces and fifteen wolves.  
And you, my mistress, that your beauty shall quickly leave you  
And that your husband shall see you and not recognise you.

<sup>1</sup> p. 41.

Your beautiful daughter, put her in the basket  
 And hang her high that the fleas may not eat her.  
     Many years off your life,  
     And a cup of mice  
     And a sieve of onions  
             For many years !'<sup>1</sup>

(2) *Praises of the Master.*

In many of the longer carols there is the episode of the waking of the master. Examples occur in IV (*a*) and IV (*e*), given above, as well as in IV (*f*) and III (*c*). The last I will quote:—

' In these houses tall and built of marble,  
 Whose stones are gold and whose mortar is silver  
 And right in the midst of the house lies St. Basil asleep.  
 " Who is worthy and able to go and wake him ?"  
 " I am worthy and able to go and wake him  
 Give me twelve apples and fifteen quinces  
 And a bottle of orange flower water that I may go and wake him."  
 Master of masters, wake and do not sleep long  
 For your sleep is long and it mars your joy.'

A curious adaptation of this convention for singing to a priest is given in *Kal.* p. 20:—

Down by the laurel river, the little laurel river,  
 There sleeps the priest with the cross in his hands.  
 No one goes to wake him, no one goes,  
 Only our lady, the Blessed Virgin with Christ in her hand.  
 ' Wake and rise, master, and do not sleep heavily.  
 The monasteries are ringing and the churches are saying the service  
 And your little clerks are singing your name.'

For the rest, the good wishes for the master are pretty fairly represented in the specimens of carols given above. The singers wish him a walnut chair to sit on, a crown on his head, a charger to ride, and so much money that with one hand he may measure it and with the other spend. Often, too, they wish that he may fit out a ship and make successful voyages and bring back a cargo of gold from England. In Passow, 304, this convention is developed at length in honour of the captain to whom the carol is sung. The various parts of the ship are

<sup>1</sup> These lines are printed in *Kal.* p. 20. A note on Passow, No. 294, gives the last three lines together with the conclusion modestly omitted by the chap book

Μὲ τὸνα χέρι ζύμωνε, μὲ τ' ἄλλο ξεῖ τὸν κῶλον.

This is a parody on the good wish

Μὲ τὸνα χέρι νὰ μετρᾷς, μὲ τ' ἄλλο νὰ δανείζης.

Wace has quoted this abusive doggerel as used by the mummers and adds another example, *B.S.A.* xvi, p. 236.

of precious metals and so forth, Christ is at the prow, the Virgin amidships, and St. Nicolas, the patron saint of shipping, holds the tiller.<sup>1</sup>

Perhaps the most poetical praise of the master is that given in *Kal.* p. 16:—

‘My master, in your house a golden candlestick gives light,  
It lights the guests to dine, it lights the guests to lay them down.  
And it lights too your resting place<sup>2</sup> that it may be strewed for you to go to sleep,  
That it may be strewed with roses, that you may lie on flowers,  
And that the blossoms may fall upon you and the apples at your feet  
And the tender twigs round about in your bosom.’

There are, further, the appeals to the master to put his hand in his embroidered pocket. In one case at least the embroidered pocket seems to have taken on the character of the clothes made for the son by the three princesses. I (*a*) has —

‘Open your pocket embroidered in silver  
Which these virgin maidens broidered for you,  
Maidens with golden hair forty-five cubits long,  
And the fates looking on it with pride flew away with it,  
To the heavens they spread it out, upon the fields they wind it  
And in the foam of the sea they tie and untie it.’<sup>3</sup>

(3) *Praise of the Mistress.*

All popular poetry is very highly conventional. Often the conventional passages are put in *mal à propos*. A word may automatically suggest them whether suitable or not, in the same kind of way that in conversation the suggestion of a word belonging to a catch phrase is an invariable temptation to the duller minded. A case in point is IV (*e*). From the examples of the carols quoted it will be obvious that the commonplace regularly addressed to the mistress is that she wears the Sun for face, the Moon for breasts, and the raven’s wing for her arched (*καμαρόφρυδι*) or silken eyebrow (*γαϊτανόφρυδι*). This is taken from the common stock of Greek romantic poetry. To take a random instance, in the ballad of the *Sister of Costandi*<sup>4</sup> we find:—

ἔκατσε καὶ στολίστηκε τρεῖς μέρες καὶ τρεῖς νύχτες,  
βάνει τὸν ἥλιο πρόσωπο καὶ τὸ φεγγάρι στῆθος,  
καὶ τοῦ κοράκου τὸ φτερὸ τὸ βάνει ματοφρύδι  
καὶ τ’ ἄστρο τοῦ ἀγγελιοῦ τὸ βάνει δαχτυλίδι.

<sup>1</sup> Στὴν πλήρη κάθετ’ ὁ Χριστὸς, στὴν μέσ’ ἡ Παναγία  
Καὶ πίσω στὸ τιμόνι τοῦ κάθετ’ ἄγγελος Νικόλαος.

<sup>2</sup> The word is *καλοῦδα*. I do not know its meaning.

<sup>3</sup> This commonplace we have met in IV (*e*).

<sup>4</sup> Λαογραφία, i, p. 596.

It is sometimes overlooked, particularly by enthusiasts, that all popular poetry, and particularly improvised poetry, is less an original invention than the ready grouping of conventional commonplaces. It is this fact which explains why it seldom sinks below a comparatively high standard and, with few exceptions, never rises to greatness.

One carol, III (c), adds to the commonplace above noted the pretty thought of roses springing beneath the lady's tread.<sup>1</sup> *Kal.* p. 18 has:—

' My Lady, when you wish to dress and change your clothes  
The dove brings the water and the magpie the soap  
And the broidered partridge brings the three dresses.'

Doubtless 'the three dresses' are the familiar three dresses of the heroines of Greek folk-tale—the one with the earth and flowers embroidered upon it, the second with the sea, and the third with the sky and stars. Another example of the influence of the folk-tale may be detected in *Kal.* p. 15, where the lady's portrait is said to be hung up in the king's chamber.<sup>2</sup> Frequently in folk-tale the prince espies his fate in some such royal portrait gallery.

In addition to these images we have seen the mistress likened to a church with a drinking fountain,<sup>3</sup> to us a curious comparison, though it is also applied to his lady by the lover in carols of Type II.<sup>4</sup> The fountain occurs without the church in IV (f):—

μὰ σὲ κερά μου σοῦ πρέπει ν' ἄσαι ἀβγένεια βρύσι  
κί' ὄσοι περάτες κί' ἂν περνοῦν, περάτες κί' ἂν περῖσουν  
κρύο νερὸ νὰ πίνουσι, τὸν Κύριον νὰ δοξάσουν.

(4) *Praise of the Daughter.*

The praise of the daughter is as stereotyped as that of her mother. Examples will be found above in II (c), III (c), and IV (d). Her like is not to be found in Venice nor in Constantinople. A learned man seeks her in marriage, but he asks an enormous dowry—fields of corn and

<sup>1</sup> σὰν σιστῆς καὶ λυγιστῆς καὶ πᾶς ἴστην ἐκκλησίαν  
ἢ στράτα ῥόδα γέμησεν ἀπὸ τὴν περκατιζιά σου.  
βάνεις τὸν ἥλιο πρόσωπον κτλ.

<sup>2</sup> Κυρὰ μαρμαροτράχηλη, κορώνα φορεμένη  
Ἰστοῦ Βασιλῆα τὴν κάμαρη σ' ἔχουν ζωγραφισμένη.

<sup>3</sup> IV (d), p. 46.

<sup>4</sup> Above, p. 37.



vineyards, and all the ships and the north wind to sail them home.  
I (c) adds the marriage feast:—

But after the marriage service he will kill a thousand oxen  
And nine thousand sheep and three thousand goats  
That his friends may eat and drink and his enemies burst.<sup>1</sup>

Where the *γραμματικός* is not mentioned the singer expresses the pious hope that she will wed the son of the king of Spain.<sup>2</sup>

*Kal.* p. 18 gives a form which is out of the common:—

‘Lady, your daughter, Lady, your dear one  
You wash her, you comb her, you hide her in the clouds  
And they rent the clouds and the maiden appeared.  
There appeared her golden hair and her royal tresses.  
The priest saw her and shivered, the deacon went out of his mind.  
And a merchant saw her, he falls on the ground fainting.  
A jar of water they threw on him, they throw a jar of water on him.  
“Rise, my fine Merchant, that I may make you a bridegroom,  
Bridegroom to my daughter, bridegroom to my dear one  
Who has eyes like olives and eyebrows like silk,  
Her dainty eyelashes like the fringe of a handkerchief.”’

(5) *Praise of the Son.*

The sons are usually sent to school, where the master beats them.  
The simplest form of this *motif* is found in Passow, No. 294:—  
Lady, with the many sons who are brought up on musk  
Well trained to diligence and to good behaviour  
Whom you wash and comb and send to the school  
That they may learn graciousness and to be gentlemen; many instructions you give them  
And there the master beats them, and there he flogs them,  
With three twigs of basil he terrifies them.

In the more elaborate form, of which some examples will be found above,<sup>3</sup> the boy goes to school, drops his taper, which sets light to the paper and books and the satchel or clothes which were broidered for him by three princesses.<sup>4</sup>

<sup>1</sup> Μὰ ἄν θὰ τὴν εὐλοηθῆ θὰ σφάξῃ σίλιγ βοῦδια  
καὶ ἐννιά σιλιάδες πρόβατα καὶ τρεῖς σιλιάδες γίδια  
νὰ τρῶν νὰ πίνουν φίλοι του, νὰ σκάσουν οἱ ὄχτροί του.  
<sup>2</sup> e.g. I (a) κὶ ἄν ἔχῃς θηλυκὸ παιδί, χρυσῆ μοῖρα νὰ λάβῃ,  
τοῦ Ῥήγα Σπάνια τὸ ὑγιὸ ἄντρα νὰ τόνε πάρῃ.

Cf. IV (d).

<sup>3</sup> II (c), III (a), IV (d).

<sup>4</sup> The variants of the embroidery of the three princesses are  
ὡ μὲ βανε τὸν πόθον της κ' ἡ ἄλλη τὴν καρδιά της  
κ' ἡ ἄλλη ἡ ὀλοῦστερη βάνει τὴν εὐμορφιά της  
or, ἡ μὲ βάλε τὸν πόθο της, κ' ἡ ἄλλη τὸ μετᾶξι  
κ' ἡ τρίτη ἡ καλλίτερη τὸν οὐρανὸν μέτ' ἄστρη  
or, ἡ μὲ ἦτανε τοῦ Πρίγκιπα, κ' ἄλλη τοῦ Βεζύρη  
κ' ἄλλη πιδ μικροτέρη τοῦ Μέγα Βασιλέως.

A wish is often expressed that he may become a priest, as in II (c). III (c) has the same wish similarly expressed.<sup>1</sup>

Another blessing commonly invoked on the son occurs usually in the epilogue of thanks at the close. It is curiously far-fetched. A good example will be seen above, IV (d). It is hoped that he will go for a ride and fall off his horse; his pocket is so full of gold pieces that they are scattered far and wide for lesser folk to pick up.

*Kal.* p. 17 has a form which I have not seen elsewhere:—

‘Lady mine, your little son, lady, your dear one,  
Five little maidens are in love with him and eighteen big ones.  
And one said to the other and one says to the other,  
“Come and let us give him a button and a ring  
That he may wear the ring and play with the button,  
That he may go and take his pleasure in the fields on horseback,  
That he may catch hares in the fields and partridges in the marshes.  
And here in the twisting gorges he catches three fawns,  
The one he takes to his mother, the other to his sister,  
The third the best to his beloved.”’

*The praise of the Serving Maid* calls for little comment. It consists of a series of appeals for the various delicacies of which she controls the receptacles. A good example is that given above in IV (b).

W. R. HALLIDAY.

#### NOTE ON THE FRAGMENTS OF THE GYPSY CAROL.

The following fragments of a Gypsy carol in honour of St. Basil have been supplied to me by Dr. John Sampson. The references are to Paspáti, *Études sur les Tchinghianés*, from which he has excerpted and pieced together the relevant quotations.

A. *Áyo Vasilí avéla*  
*Pi lolí djorniása.*

St. Basile vient avec son mulet rouge ('Ch[anson] du premier jour de l'an,' p. 228 s.v. *Djornt*).

<sup>1</sup> The variations known to me are:—

	ἔχεις καὶ γυνὴ 'στὰ γράμματα καὶ γυνὴ εἰς τὸ ψαλτῆρι	
στ,	ἔχεις καὶ υἶδ καὶ ὄμορφο που λέγει στὸ ψαλτῆρι	
στ,	ἔχεις καὶ γυνὴ στὰ γράμματα καὶ σὺρνει τὸ κανδῆλι	
	ἔπου νὰ τὸν ἀξιῶσ' ὁ Θεὸς	} νὰ Βάλλη πετραχῆλι.
	νὰ τὸν ἀξιῶσῃ ἡ Παναγία	
	νὰ δώσῃ ὁ Θεὸς κι' ἡ Παναγιά	

Clearly this has been taken over by the Gypsies from a carol of Type I. I cannot with confidence explain the 'red mule.' It may be due to verbal corruption. St. Basil has often strange accessories (*v.* above, p. 35, note 3) and *κόκκινο μουλάρι* is conceivably a corruption of *χαρτί και καλαμάρι*. At the same time the paper and ink horn are essential to the story. I know of no Greek instance in which the red mule occurs. Another possibility is that the red mule might figure in some mumming play and thus have come into the ballad. So far as I am aware, however, it does not figure among the *dramatis personae* of any Greek mummers.

*B. Me, tuménde nána beshána, ne te khav, ne te píav.*

Moi, chez vous je ne m'assieds pas (réside), ni pour manger, ni pour boire. ('Ch. St. Basile,' p. 173, *s.v.* *Beshána*.)

Paspáti's gloss '(réside)' appears to be mistaken: clearly this is a refusal of the invitation

*κάτσε να φῆς, κάτσε να πῆς, κάτσε να τραγουδήσης.*

There are further two fragments stated by Paspáti to belong to a St. Basil carol which it is difficult to place exactly. There is no difficulty in supposing that they might occur incidentally in one of the Greek carols.

*C. Me kamáma te djav ko tchoró Pánkos*

Je veux aller chez le pauvre Pánkos. ('Ch. du St. Basile chantée au premier jour de l'an,' p. 262, *s.v.* *Kamáma*.)

*D. Gheló ko tchoró Pánkos, otiá khale, pile, keldé khóros,  
Ghiliábiletar trin divés ta trin rattid.*

Il alla chez la pauvre Pánkos, là ils ont mangé, bu, joué la danse (dansé), chanté, trois jours et trois nuits. ('Ch. de St. Basile, chantée au premier jour de l'an,' pp. 245, 398 and 551, *s.v.* *Ghiliábava, Otiá* and *Tchoró*.)

The name Pánkos occurs also in a sentence on p. 257, *s.v.* *Kak*. Dr. Sampson tells me that -os is the Gypsy masculine termination, and he is of opinion that Pánk- is derived from some Greek original. If so the original is probably one of the dialect forms of Παναγιώτης of which Πανιός, Πάνος and Μπάνος are recorded by Buturas.<sup>1</sup>

W. R. H.

<sup>1</sup> 'Αθανασίου Χ. Μπούτορα, Τὰ Νεοελληνικά Κύρια Ὄνόματα, p. 96, *s.v.* Παναγία.

## THEVET'S *GRAND INSULAIRE* AND HIS TRAVELS IN THE LEVANT.

(PLATE VIII.)

TWO folio volumes in the Bibliothèque Nationale (*MS. Fr.* 15, 452-3) contain an ambitious work by André Thevet on the islands of the world, entitled *Le Grand Insulaire et Pilotage d'Andre Thevet, Angoumoisain, cosmographe du Roy, dans lequel sont contenus plusieurs plants d'isles habitées et déshabitées et description d'icelles*. The date 1586 is scribbled on the back of one of the maps in vol. i. and checked by a reference on f. 112, which gives the date of the *Insulaire* as twenty-five years later than a voyage undertaken by the author to the New World in 1551.<sup>1</sup> We may thus take the date of the composition as lying between 1576 and 1586.

The first volume of the *Insulaire* (numbered ff. 413, of which nineteen are blank, *plus* thirty-two unnumbered written sheets) contains descriptions and many engraved maps of the North European and East Indian Islands, Japan, the Canaries, and the islands of the New World. The islands described in the second volume (numbered ff. 230, of which five blank, *plus* fifty-five unnumbered but written pages) are all in the Mediterranean, Adriatic, Aegean and Black Seas and are arranged (?) in the following order, those printed in Roman type being illustrated with engraved maps:—

*Cadis, Fromentaire, Minorque, Maillorque, Sardaigne, Corse, Les Isles posées au Lac de Thrasymène, Elba, Gerbe, Malte, Lesante, Aegine, Pago, Candie, Gose de Candie, Veggia, Corfou, Grande Cephalonie, Petite Cephalonie ou Val de Compare, Isle et Bataille de Lepante, Echinades, Nisare dict Calojero Cursola, Venise, Zassé, Bua, Pascu, Sicile, Episcopia ou Dulifonisia, Chesepritri, Cerigo, Provençal, Liesene, Parjo, Cecerigo,*

<sup>1</sup> The real date of this voyage is, however, 1555-6.

*Duché*, Antimilo, Caloiero d'Andros, *Brazze*, Church, Piane, Mile, Sapience, Specie, Anticlare ou Capra, Strongyle, *Isle du Port Cauaijer*, Remouille, *L'Hero*, *Magonisse*, Andros, Amurgospole, *Larisse*, Parjo, *Euboea*, Nissare, *Parje*, *Ronzin*, *Fermene*, Sicandre, Cypre, Dromos et Sarrachine, *Samos*, *Isle du Serpent*, *Nixia*, Serfine, *Stampalea*, *Scarpante*, *Simje*, *Plenise*, *Isles Chelidoniennes*, *Pathmos*, Rhodes, *Iasse*, *Calchi et Limonje*, Coo à présent Lango, Metelin, Acre, Chios, *Tine*, *Sydre*, *Limene*, *Policandre*, *Micole*, *Namphie*, *Zea*. *I. des Cerfs*, Claro ou Calamo, Chorsée, *Isles de Tyre*, *Isle de Sayt*, *Isle de Barutti*, *Isle de Meroe*, *Lemnos*, *Tenedos*, *Marmora*, *Fornose*, *Phase*, *Fidonise*, *Prodene*, *Isles de la Rose*, *Aspropyra*, *I. d'Achilles*, *Isles de Samastre*, *Alopetie*, *Saraich*.

Engraved maps of the same series have been published in Legrand's edition of Buondelmonti<sup>1</sup> and in Schefer's of Denis Possot<sup>2</sup> from a volume in Schefer's possession: several of the titles of the maps are slightly different from Thevet's. Others are to be found in the Royal Library at the British Museum.<sup>3</sup>

The originals of these maps, with which the author had designed to supplement the description of every island, are said by him to have been derived in many cases from local sources. Thus the map of Astypalaea was acquired in Nicaria, that of 'Anticlare' from Theodosius, a monk of Athos, that of 'Larisse' from a Genoese sailor, that of 'Episcopia' from a dragoman of the Grand Signior who had stolen it with others from a Greek of Negropont. But Thevet was acquainted with and mentions the *Isolario* of Bordone which contains island-maps, and certainly also with that of Porcacchi, the style of whose maps he follows. The stories by which Thevet accounts for his maps look suspiciously like fiction.<sup>4</sup>

Of the text of the *Grand Insulaire* only extracts have as yet been published. These include the sections on Haiti<sup>5</sup> and 'Alopetie' (at the mouth of the Don),<sup>6</sup> those on Venice, Zara, Bua, Corfou, S. Mavra,

<sup>1</sup> Thirty-six maps, of which fifteen seem to be new to the collection inserted in the *Insulaire*.

<sup>2</sup> Corfu, Nicaria, Venice, Cyprus.

<sup>3</sup> Pressmark K. 113, six maps (Brazza, Bua, Cursola, Pago, Veggia, Zara), of which three (Bua, Cursola, Pago) do not occur in the MS. of Thevet's *Insulaire*.

<sup>4</sup> In Thevet's *Pourtraicts et Vies* similar fanciful stories are related of the portraits of Dionysius of Alexandria (taken from a MS. acquired at Athens, p. 12) and of Philo (found in an excavation at Alexandria, p. 85) where the portraits speak for themselves.

<sup>5</sup> Ed. Schefer and Cordier (*Recueil de Voyages*, iv.) Paris, 1883.

<sup>6</sup> Ed. Boyer, *Vocabulaire Français-russe*, in *Mém. Orientaux*, Congrès de 1905, Paris, 1905.

Cephalonia, Sapienza, Cerigo, Carpathos, Nisyros and Cyprus,<sup>1</sup> and on Delos<sup>2</sup> and the city of Chios.<sup>3</sup> The work contains much curious information on the islands of the Aegean gathered from very various sources (seldom acknowledged), as well as from what purports to be the author's personal experience. The value of this necessarily depends on the general reliability, and especially the good faith, of the author.

André Thevet (1502-1592) is well known in connection with the Levant by his *Cosmographie du Levant* (Lyon, 1554, etc.) which is based on his travels between 1549 and 1554, and the later *Cosmographie Universelle* (Paris, 1575, 2 vols. folio), a more general work which includes much additional matter on the Levant. Thevet makes frequent allusions to his Levant travels also in his *Pourtraicts et Vies des Hommes Illustres* (1584).

The value of Thevet's work has been very variously estimated. Regnard, in Firmin Didot's *Bibliographie Universelle* sums up his account of our author that his works 'sont tombés dans un oubli mérité': his latest defender, Gaffarel, esteems Thevet 'trop attaqué de son vivant, mais trop oublié après sa mort.'<sup>4</sup>

As to the new information on the Aegean islands contained in the *Insulaire* there is much that cannot be checked. Particularly noteworthy is Thevet's frequent mention of the Jews in the islands. Thus

- (1) Two synagogues are mentioned at Calymnos (f. 182).
- (2) One at Tenos, where was born a learned Jewish translator of Aristotle (f. 168).
- (3) A Jewish doctor is mentioned at Amorgos (f. 113).
- (4) Jews are also mentioned at Aegina (f. 31), Anaphi (f. 193),<sup>5</sup> Astypalaea (f. 143), Spetsa (f. 99) and Zea (f. 174).

<sup>1</sup> In Schefer's edition of Denis Possot (*Recueil de Voyages*, xi. (1890), 245 ff.).

<sup>2</sup> Ed. Holleaux in the French School's publication *Delos*, section *Cartographie*, App. iii.

<sup>3</sup> *B.S.A.* xvi. 183 f.

<sup>4</sup> *Bulletin de Géographie historique et descriptive (Commission de Travaux Historiques et Scientifiques)*, 1888, 201. The same author makes a similar attempt to defend Thevet in his edition (1879) of *Les Singularités de la France Antarctique*.

<sup>5</sup> The story of a Jew at Anaphi recorded by Thevet is too quaint to omit:—

(*Insulaire*, f. 173). 'Ce mot de Namphie est un mot Grec vulgaire corrompu qui ne signifie autre chose en nostre langue que Isle sans serpent, la raison est telle suiuant l'histoire des Insulaires qu'il ne s'y trouua jamais serpent ny autre beste venimeuse, encore que plusieurs Philosophes en ayant apporté par curiosité de [la] terre continentale, entre autres un Juif que l'on appelloit Azarias, lequel apporta de la Morée deux grandes fioles de verre pleines de ces bestes serpentines et vipères aussy, les quelles bestes furent mises toutes en vie dans vn grand jardin du pere du dit Juif, nommé Athalai riche marchand natif de

These details can in no case be corroborated from contemporary sources. There is, so far as I know, no other record of Jews on any of the islands mentioned except possibly Tenos, which was Venetian in Thevet's time. If the information is true it is exceedingly interesting, since the date at which Thevet travelled coincides with that of the greatest influence and importance of the Jews in Turkey; it can hardly come from other than a Jewish source. It is known that Thevet prepared a translation of Benjamin of Tudela's travels (1160-1173), of which the first edition appeared in 1543 at Constantinople;<sup>1</sup> he may have had relations with the Jews there or at Rhodes (where there is a strong Jewish colony), since he visited both places on his Levant voyage.<sup>2</sup> But, given Thevet's acquaintance with Benjamin's travels, which include a description of the Jewish communities in the Aegean islands, it is at least equally possible that our author has merely improved on his twelfth-century predecessor.

We may further cite Thevet's numerous references to mediaeval history and antiquities not recorded elsewhere. These are numerous and circumstantial. Examples are:—

- (1) A revolt of the people of Telos in 976 and the name of their first bishop, Macedonius (f. 77).
- (2) Flight of the inhabitants of Hydra to the mainland in the reign of Constantine Paleologus (f. 169).
- (3) Latin inscription of a Teutonic knight at Tenos (f. 168).
- (4) Tower built in 1403 by 'Alexius' on Amorgos, to defend the island against the pirate Zachas (f. 113).
- (5) Tower built by 'Calojannis' on Spetsa (f. 99).
- (6) Castle built by Michael Parapinaces on Astypalaea (f. 143).
- (7) Tower built by Scanderbeg on Zea (f. 174).
- (8) Castle of S. Lazarus built by de Beckford, thirteenth Grand Master of the Teutonic Knights, at Porto Cavaliere on the Karamanian coast (f. 104).

Ramad ville en Judée. Ceste vermine ayant pris et gousté l'air et la terre de l'Isle incontinent moururent present plusieurs personnes.' The idea, based evidently on the false etymology of the name of the island, comes from Buondelmonti's (1420) *Liber Insularum* (§ 41) the names being our author's inventions. This, as we shall see, is a fair sample of his methods of composition.

<sup>1</sup> A copy of this rare book is said by Asher in his edition of Benjamin (ii. 3) to have existed in the Bibliothèque Nationale, though it could not be found for his inspection: Thevet may have made his translation from it.

<sup>2</sup> Below p. 63.

- (9) Castle built by Charles of Anjou-Naples on Leros (f. 109).  
 (10) The 'croix de Malte' to be seen in the castle at Syme (f. 147).

Of these (9) is clearly enough a confusion with Castellorizo, the occupation of which, under Alfonso V. in 1451 by a Neapolitan fleet, is mentioned by several fifteenth-century pilgrims and by Bosio.<sup>1</sup> As to (10) Mr. Dawkins tells me that the heraldry of Syme castle includes the 'croix ancrée' of the Rhodian Grand Master d'Aubusson, the form of which approximates to that of the 'Maltese' cross. Of the rest we can only say that they seem at best (*e.g.* (7), which may have been an Albanian tradition)<sup>2</sup> to have come from local sources, at worst from an inventive brain. The confusion in (9) is damaging. Still more so is Thevet's ignorance as to important events in the islands during his own century; for example neither the depopulation nor the re-settling of Samos<sup>3</sup> is mentioned, nor the earthquake at Santorin in the seventies.<sup>4</sup> These he would undoubtedly have been told of had he been in touch with islanders.

On the evidence of the *Insulaire* alone we should thus convict Thevet of blundering, and be inclined to suspect him of drawing on his imagination, or, at best, of a rash use of indifferent sources. When we come to investigate his travels as set forth in the *Cosmographie du Levant* we find our suspicions of his good faith more than justified.

Thevet made his Levant voyage between the years 1549 and 1554. According to his own account he started in June, 1549; he took ship from Venice, touched at Ragusa, and landed at Candia about the middle of July. He stayed in Crete four months, left from Canea on All Saints' Day (Nov. 1), and proceeded *via* Melos (Nov. 11) to Chios, where he was again detained a considerable time. He then made his way, landing *en route* at Alexandria Troas, to Constantinople, arriving Nov. 30. The description of Constantinople is long but not very informing; the only excursion mentioned is to Chalcedon (Kadi-Keui) in company with Pierre Gylles. Leaving Constantinople Thevet sailed for Rhodes, but was driven by a storm to Athens: to the description of Athens we shall return. From here he made his way to Rhodes, which he reached Nov. 2, 1550, re-embarking thence for Alexandria. He stayed four months in Egypt, leaving on March 23 for a tour to Sinai, Palestine, and Syria, and finally

<sup>1</sup> *Historia della S. Religione di S. Giovanni*, ii. 238, 334.

<sup>2</sup> For Albanians in Zea see *B.S.A.* xv. 226.    <sup>3</sup> *B.S.A.* xvii. 169.    <sup>4</sup> *Ibid.* 180.



embarking at Tripoli for Cyprus, Rhodes, Candia, and Marseilles. The last date given in the itinerary is that of our author's departure from Jerusalem—'five days after Easter [1552].' He was certainly home in France by 1554, the date of the first edition of the *Cosmographie du Levant*.

There are considerable discrepancies in Thevet's own works as to the dates of his itinerary. In the *Cosmographie Universelle* he says he left Venice in 1547, not 1549,<sup>1</sup> and that he spent two and a half years in Alexandria<sup>2</sup> (where, according to the *Vies* he spent nine months),<sup>3</sup> and that he returned to Marseilles in 1551.<sup>4</sup> A poem by his friend Baif says he spent two years at Constantinople, nine months in Crete and the same period at Alexandria, two months in Chios and three in Cyprus.<sup>5</sup>

Thevet's first-hand knowledge of the islands is thus, on his own showing, confined to Crete, Melos, Chios, and Rhodes. Yet in the *Insulaire* he claims to have visited Zea, Amorgos, Syme, Lemnos, Nicaria, and other islands.<sup>6</sup> We have no reason to believe that his travels were more extensive than the *Cosmographie du Levant* makes out: if anything the reverse is the case.

Laborde, in all probability rightly, suspected that Thevet had never visited Athens,<sup>7</sup> the only point in his travels which does not fall into the ordinary round of a voyage including Constantinople, Egypt, and Palestine. The one trace of autopsy in his description of Athens is a picturesque personal episode, such as we shall learn to mistrust, of the author's discovery, under the guidance of a Greek renegade, of a highly improbable inscription. In Thevet's time little on contemporary Athens had been published: the Athens of the *Cosmographie du Levant* is a vague and conventional ruined city full of 'obelisks,' 'columns,' and 'buildings like the Coliseum' as befitted its classical past. The one building which can be identified is 'Un Theatre assis sus grands pilliers de marbre, duquel les Grecs auoient fait une Eglise de S. André.'<sup>8</sup> This, which evidently refers to the Theseum, comes nearly word for word from the poem of the

<sup>1</sup> ii. 778.      <sup>2</sup> ii. 805.      <sup>3</sup> So Weiss in Michaud's *Biographie Universelle*.

<sup>4</sup> i. 161, 205.

<sup>5</sup> This poem is reprinted in Gaffarel's edition of Thevet's *Singularitez* (preface, x. ff.). Gaffarel himself wishes to spread the Levant travels over seventeen years.

<sup>6</sup> In the *Vies* (i. 17) he pretends to have visited Carpathos, and in the *Cosmographie Universelle* (233b) Samos.

<sup>7</sup> *Athènes*, i. 49 ff.

<sup>8</sup> *Cosmographie du Levant*, 99 f.

Sieur de la Borderie, published in 1542, describing his adventures with S. Blancard's fleet (1537).<sup>1</sup> Characteristic of our author's methods are the improvements introduced into the account of Athens in the *Cosmographie Universelle*. The text includes a Latin version of the well-known inscription of the arch of Hadrian, which the author affirms he had himself seen written *in Latin* on a column.<sup>2</sup> The view of Athens from the sea, which accompanies this description (Pl. VIII.), and does not figure in the *Cosmographie du Levant*, is again quite conventional. The arch of Hadrian is not shown, and the only recognizable monument is the lion of the Piraeus, represented as a fountain near the upper right-hand corner of the block: this is in conformity with the description of it in S. Blancard's journal,<sup>3</sup> with which Thevet presumably became acquainted between 1554 and 1574.

The same development between the *Cosmographie du Levant* and the *Cosmographie Universelle* is apparent in the account given of the Lemnian earth. In 1554 Thevet is vaguely conscious that the earth came from somewhere near Athos. In 1574 he gives a most elaborate account of its digging, nearly every detail of which is pirated without acknowledgment from Belon, inserting (1) the very improbable text of the proclamation of the digging, and (2) a picturesque and convincing personal episode of the author's conversation with a local Greek.<sup>4</sup>

The illustrations of the two works shew exactly the same development. Those of 1554 are mainly of animals, an idea borrowed from Belon's *Observations*. Exceptions are the tolerable view of the column at the entrance to the Black Sea (inscribed *CAESAR* and without a capital)<sup>5</sup> and of the hippodrome at Constantinople, and the purely fantastic figure of the Colossus at Rhodes.<sup>6</sup> In the *Cosmographie Universelle* the column of the Black Sea receives an Ionic capital and the inscription *CAESAR TANTUS ERAT QUOD NULLUS MAIOR IN ORBE* (!),<sup>7</sup> the hippodrome is provided with an architectural background (possibly owing something to Lorch's engraving), while the identical Colossus of Rhodes is shewn

<sup>1</sup> The poem is most accessible in Laborde's *Athènes*, i. 257 ff.

<sup>2</sup> *Cosmog. Univ.* 795 b; the inscription (*I.G.* iii. 401, 402) was first copied by Cyriac of Ancona, first printed, apparently, by Crusius (*Turcograecia*, (1584) 461).

<sup>3</sup> In Laborde, *op. cit.* i. 47: 'au bout de la mer avoit ung gros lyon de pierre par lequel au temps passé sortoit une fontaine.' S. Blancard's diary remained in manuscript till its publication in Charrière's *Négotiations de la France dans le Levant*, i. (1848).

<sup>4</sup> On this see *B.S.A.* xvi. 223. <sup>5</sup> p. 79. <sup>6</sup> p. 104. <sup>7</sup> p. 266 b.

standing across the harbour-entrance of *mediaeval* Rhodes, this setting being only too evidently derived ultimately from Reuwich's well-known view. This composite picture was acquired, according to our author,<sup>1</sup> from the usual local Greek, and is used as evidence for the incorrectness of Münster's statement that the Colossus had been destroyed by an earthquake, which is of course historical fact.

Of the new illustrations in the *Cosmographie Universelle* some (e.g. Athos, Lemnos) can be traced to Belon, others of Venetian towns (e.g. Nauplia, Famagusta) to Venetian publications of the Lepanto period.<sup>2</sup> Those representing inscriptions, of which one at least has found a place in Boeckh's *Corpus*,<sup>3</sup> generally betray themselves by their texts as forgeries. The epitaph of Periander (in modern Greek), which Thevet pretends he saw at 'Androsia' in Achaia<sup>4</sup> is a conspicuous example of this class. The case for an inscription of Caligula at Gallipoli, recording his foundation of the city,<sup>5</sup> and another of Trajan at Trajanopolis dated by the year of Rome<sup>6</sup> is hardly strengthened by our author's claim to have seen them; moreover, he is not known to have visited either site.

In rare details Thevet seems to know Greece better in the *Cosmographie Universelle* than in the *Cosmographie du Levant*. It is remarkable that in the former he mentions the monasteries of the Meteora, placing them correctly near Trikkala:<sup>7</sup> this is so far as I know the earliest reference to the monasteries in a Western writer.<sup>8</sup> Similarly in the *Insulaire* the description of Chios is much fuller and better than that in the *Cosmographie du Levant*, indeed, than any other of this date, and bears obvious marks of authenticity.

<sup>1</sup> pp. 205 b, 206.

<sup>2</sup> The earliest view of Nauplia known to me, which is closely related to Thevet's, is in a collection of engraved maps published by G. F. Camotti at Venice about 1571 (B.M. *Maps* 6, b. 41). Famagusta is figured in various accounts of the Turkish conquest of Cyprus.

<sup>3</sup> *Cosm. Univ.* 833 (inscription from arsenal at Constantinople) = *C.I.G.* 8679.

<sup>4</sup> *Cosm. Univ.* 800. <sup>5</sup> *Cosm. Univ.* 815.

<sup>6</sup> *Ibid.* 819. The epitaph from Homer's tomb in Samos (*Cosm. Univ.* 805, *Thaphos menimory, megalos, oproctos, toup* (sic) *homivos*) is too foolish to be a pure forgery: it is probably based on an ignorant copy of a commonplace text. Even Thevet does not claim to have seen this, but says it was discovered in 1083.

<sup>7</sup> *Cosm. Univ.* 794 b.

<sup>8</sup> Another passage (p. 793) mentioning a great monastery on Parnassus I took first to be the earliest Western reference to S. Luke's in Stiris. But Mount Athos is referred to in almost identical terms by the pilgrim Alessandro Ariosto (1475-8, ed. of Ferrara 1878, 111).

We have thus found that, where Thevet's information on the Levant can be checked, the additions of the *Cosmographie Universelle* are derived partly from pillaging authentic works without acknowledgment, partly by combinations of fact and fiction covered by a pretence of special information, partly by mere forgery. There seems to be a small residue of true, but not first-hand, information from sources unknown to us. There is no injustice in supposing that the new information contained in the *Insulaire* is of the same blend. It is evident from a spiteful passage in the preface to the *Pourtraicts et Vies*<sup>1</sup> that Thevet's contemporaries were sceptical of his 'traveller's tales' from the Levant.

The estimate formed of Thevet's personal and literary character by one of the most eminent of these, de Thou, is of special value. De Thou knew Thevet personally; he had, so far as is known, no grudge against him, but wished to put other *savants* on their guard against taking the 'cosmographer royal' too seriously. He charges him, contemptuously rather than spitefully, with extreme ignorance, credulity and vanity, and describes his method of work as a botching together of extracts taken from other writers without the least discrimination as to their authority.<sup>2</sup>

Gaffarel, who can find no reason to suspect a quarrel between Thevet and de Thou, finds this condemnation surprising.<sup>3</sup> But the judgment of de Thou is in reality lenient, since it diagnoses vanity and ignorance, but not dishonesty. Of the latter Thevet was convicted in his own time by de Léry in connection with his travels in Brazil (1555-6). Here the field for imagination was wider and the chance of detection slighter

<sup>1</sup> p. b. ij.

<sup>2</sup> *Hist. Sui Temporis*, Liv. xi. *ad fin.* (Paris, 1604, ii. 248 f.); 'professione primo Franciscanus, dein, cum uix litteras sciret, abiecto cucullo ex monacho celeberrimus planus relligiosis & aliis peregrinationibus primam aetatem contriuit, ex quibus fama contracta, animus ad libros scribendos inepta ambitione applicuit, quos alieno calamo plerumque exaratos & ex itinerariis vulgaribus atque huiusmodi de plebe scripturis confarcinatos, miseris librariis pro suis venditabat, nam alioqui litterarum, antiquitatis, atq. omnis temporum rationis supra omnem fidem fuit imperitus; vt fere incerta pro certis, falsa pro veris & absurda semper scriberet. equidem memini cum amici quidam mei viri docti & emunctae naris ad eum animi gratia ventitarent, me praesente tam absurda quaedam, tam ridicula, quae pueri uix crederent, illi persuasisse, vt ipse risum non tenerem. vt me hodie misereat multorum, qui cum in litteris multum videant, agyrtae tamen illius fucos non solum non peruideant, sed eius nomen cottidie in libris suis honorifice appellent; mirarique saepius subiit qui (*sic*) fieri poterit vt homo, cui tam facile imponeretur, tanti nominis viris tam turpiter imponat: quos ideo nunc monitos cupio, vt in posterum insciti et inepti nebulonis nomine ac testimonio praeclara scripta sua contaminare desinant.'

<sup>3</sup> In his edition of Thevet's *Singularitez* (preface, xxx).

Owing to an illness which detained him on board ship Thevet actually saw very little of Brazil, though he wrote a considerable book on it. On his map figured a town called, in compliment to Henri IV, 'Ville Henri.' This town de Léry, who had real knowledge of the country, assures us never existed.<sup>1</sup> The testimony of Thevet's contemporaries thus coincides exactly with the estimate we have formed of him independently from an examination of his works on the Levant.

Thevet's untrustworthiness seems largely due to his childish vanity and his ambition to be considered a great man. These characteristics are illustrated by the very titles of his books, which betray his desire to compete with works and authors of established reputation.<sup>2</sup> His adoption without the slightest acknowledgment of the material of others, though he based his excellence as a 'cosmographer' on autopsy, has already been noticed. As a scholar he evidently possessed some erudition of a bookish sort,<sup>3</sup> rather badly digested, and a desire for curious knowledge. He seems to have been entirely lacking in critical faculty and was consequently capable both of inventing and reporting obvious improbabilities. A good friend to those who accepted him at his own valuation, he was a bitter enemy to those who were acute enough to see through his pretensions. From the study of his printed works we have seen that his vanity stimulated him to interpolate wholly fictitious incidents intended to show the extent of his travels and his intimate knowledge of the countries he had visited. In some cases his credulity, which is in the hands of his defenders the chief argument for his good faith, may have allowed him to set down what he heard without discrimination as to sources or probabilities. But he has been convicted sufficiently often of deliberate falsification.

<sup>1</sup> J. de Léry, *Histoire d'un Voyage en la Terre du Brésil*, 3rd ed. (Geneva, 1580), 89. The author's opinion of Thevet is given at some length in the preface.

<sup>2</sup> Several of his works are obvious plagiarisms in form. The *Cosmographie du Levant* is a more pretentious, but infinitely less valuable version of Belon's *Observations* (1553, etc.); the conception of the *Cosmographie Universelle* is taken from Münster's *Cosmographie* (1554, etc.); and the *Grand Insulaire* is obviously an attempt to outdo Porcacchi's popular *Isolario*. In the same way we may suspect a connection between Thevet's *Pourtraicts et Vies des Hommes Illustres* and Brantôme's *Vies des Hommes Illustres* (published first in 1666), and between his *Bataille à Dreux* (1563) and de la Motte Fenelon's *Siège de Metz* (1553), which passed through many editions. It is significant that a single edition of Thevet's works was generally sufficient for the public.

<sup>3</sup> His main interest seems, as Boyer has pointed out (*Vocabulaire Français-russe*, 6), in languages. He appears from the conversation reported in *Cosmog. Univ.* 816 to have been fairly fluent and idiomatic in modern Greek.

The authority of the new information contained in the *Insulaire* is thus reduced to a minimum. The alleged personal incidents can be discarded without a second thought. Of the historical and archaeological details a certain proportion probably comes from earlier printed and manuscript sources to which Thevet had access, or from the conversation of fellow-travellers and Levantines. But the whole is rendered suspect by the wilful dishonesty of which we have found our author guilty. Though he posed as an enlightened scientific traveller and a rival of Belon, he was in reality but a survivor of the Mandeville school of mediaeval compilers, wholly lacking, however, in the simplicity and sincerity which render these immortal.

F. W. HASLUCK.

# DIEUDONNÉ DE GOZON AND THE DRAGON OF RHODES.

(PLATE IX.)

---

## I.—THE STORY AND ITS DEVELOPMENT.

THE story of the Rhodian knight Dieudonné de Gozon and the slaying of the great dragon of Malpasso is, largely owing to Schiller's adoption of the theme in a ballad,<sup>1</sup> one of the best-known legends of its type.<sup>2</sup> It is one of several instances in which an historical personage figures as the hero of this quite mythical adventure.<sup>3</sup>

Dieudonné de Gozon, a member of the Provençal *langue*, was the third Grand Master of the Knights of S. John at Rhodes, ruling from 1346 to 1353. He is represented as a simple knight at the time of his great adventure. As might be expected, no contemporary or nearly contemporary authority mentions the dragon-fight of de Gozon.<sup>4</sup> But so early as Mandeville and Schiltberger we find anonymous Rhodian knights figuring as the heroes of current folk-tales of the chivalric type.<sup>5</sup>

The earliest form of the de Gozon story known to us is the version set down by a noble pilgrim who visited Rhodes on his way to the Holy

<sup>1</sup> *Der Kampf mit dem Drachen* (1799).

<sup>2</sup> For dragon-legends in folk-literature see Hartland's *Perseus*, Cosquin's *Contes de Lorraine*, i. 61 ff. and Frazer's note on Pausanias, ix. 26. 7.

<sup>3</sup> Other historical personages credited with dragon-fights are Sire Gilles de Chin (d. 1127), and one of the Counts of Mansfeld (Hartland, *Perseus*, iii. 46).

<sup>4</sup> On this point see Raybaud, *Hist. des Grands Prieurs de S. Gilles*, ii. 300.

<sup>5</sup> So in Mandeville (ed. Wright, 139) a Rhodian knight has adventures with the enchanted daughter of Ypocras in Cos, in Schiltberger (ed. Hakluyt Society, 42) a Rhodian knight attempts the enchanted 'Castle of the Sparrow-Hawk,' and later in Rhodes itself a Rhodian knight takes the castle of Philereino by one of the regular strategies of folk-lore (Röhricht and Meissner, *Deutsche Pilgerreisen*, 371; Torr, *Modern Rhodes*, 91). All these are well-known folk-stories to which local colour has been given by the characterization of the heroes.

Land in 1521.<sup>1</sup> He was there told that between the city of Rhodes and the castle of Phileremo was a church of Our Lady called Malapaßon, so named because years ago the spot had been rendered impassable to travellers by a monstrous dragon which did great damage to the countryside. A French knight asked the Grand Master's leave to attack it, but the latter forbade him on the ground that the enterprise was too dangerous. Not content with this refusal, the knight went back to France and trained his horse and two dogs to face the dragon by setting them at a dummy monster made by covering a calf with a dragon's skin.<sup>2</sup> Having trained the animals, he returned to Rhodes and attacked and killed the dragon with their help, cutting off a piece of its tongue as evidence, but telling no one of his exploit. Some days after the encounter a Greek found the dragon's carcass and claimed to have killed it himself. The false claim was refuted by the knight, who produced his trophy as evidence,<sup>3</sup> but, so far from receiving honours or reward, was imprisoned by the Grand Master on the score of disobedience. He eventually became Grand Master himself, *either the third or fourth*. From this last it is clear that the legend of 1521 was already associated with de Gozon, not with an anonymous knightly hero.

If we consider the number of earlier voyages, all teeming with marvels retailed to pilgrims by the way, which have come down to us, it seems improbable that the story of Dieudonné de Gozon and the dragon was current in Rhodes much before 1521, a hundred and seventy years after its hero's death, when we first hear of it. On the other hand, we find in Cos, like Rhodes a possession of the Knights, a simple legend of a dragon-slaying with an anonymous hero current as early as 1420,<sup>4</sup> and in the

<sup>1</sup> Pfalzgraf Ottheinreich in Röhrich and Meissner's *Deutsche Pilgerreisen* (Berlin, 1880), 392-4. The learned editors recognize in this the earliest record of the de Gozon legend.

<sup>2</sup> This rather unconvincing stratagem, much elaborated in the canonized version, may have been suggested by the local legend of Phileremo alluded to above, in which the castle is taken by a similar trick, the hero and his companions disguising themselves in ox-skins (*Deutsche Pilgerreisen*, 371; Torr, *Modern Rhodes*, 91).

<sup>3</sup> The episode of the false claim, discarded in the later canonized version of the story, is a feature common to many folk-tales of this type (Hartland, *Perseus*, iii. 47; Cosquin, *Contes de Lorraine*, i. 61); in the Near East it figures in the Bulgarian legend of S. Elias (L. Shishmanova, *Légendes religieuses Bulgares*, 87 ff.) and in the Turkish of the saint Sari Saltik (Evliya Effendi, *Travels*, tr. von Hammer, ii. 70).

<sup>4</sup> Buondelmonti, *Liber Insularum*, §45; *non diu est quod serpens maximus devorans apparuit armenta, et territi omnes fugam arripiebant. Tunc strenuus vir pro salute populi duellum inceptat, dum inter bestias ruere vellet. Quod cum hoc serpens percepisset, equum*



preceding century a tradition of the bewitched daughter of Hippocrates appearing in dragon form in the same island.<sup>1</sup> Any country at all in touch with the East was likely to develop these folk-themes with a local setting. In the de Gozon legend it is the choice of the hero, and the details of his stratagem which are of special interest.

To Bosio, the historian of the Order of S. John, who wrote some seventy years later, after the departure of the Knights from Rhodes, is due the general currency of the legend. His account is very detailed, though it seems to be given with some reserve.<sup>2</sup>

The dragon lived in a cave, from which a spring flowed, at the roots of S. Stephen's hill, some two miles from the city, at a place called Malpasso. Everyone was forbidden to fight with it. De Gozon, however, resolved to defy the prohibition. He retired to the Castle of Gozon in Gascony, where his elder brother ruled, and made a dummy dragon of canvas stuffed with tow, resembling the real dragon in every particular, and so devised that it could be moved mechanically, making hideous noises as it did so. Having trained his horse and dogs to attack the dummy monster, he returned to Rhodes and set out to Malpasso by a roundabout route, sending his dogs with the servants to wait for him at the church. Hence he made his attack on the dragon's cave and after a terrific combat, slew it by a stroke in the under part of its body. In its last agonies it fell on him and he was with difficulty rescued from under it by his servants.

The incident of the Greek and the false claim is omitted in Bosio's version. De Gozon for his disobedience was deprived of his habit by the Grand Master (de Villeneuve), who, however, afterwards relented and reinstated him. In course of time the dragon-slayer became Grand Master. At his death he was buried in the conventual church of S. John, his tomb being signalized by a representation of his heroic achievement and the words DRACONIS EXTINGTOR.

*morsibus illico in terram prostratum occidit; iuuenis autem, acriter pugnans, tandem viperam interfecit.* Folk-legends of fights with dragons in Greek lands, sometimes dated more or less exactly, are given by Biliotti, *Rhodes*, 154 (Rhodes, '110 years ago'), and Polites, *Παράδοξες*, 375 (Mykonos), 381 (Skopelos), 383 (1509, Cephalonia, cf. Ansted, *Ionian Islands*, 342), 387 (1891, Rapsani). With these it is interesting to compare the crocodile story from Egypt told by Lucas (*Voyage au Levant* (1705), 83 ff.).

<sup>1</sup> Mandeville, ed. Wright 138: for the obscure connection between this dragon and the devastating monster mentioned above see note in Warner's edition.

<sup>2</sup> G. Bosio, *Historia della S. Religione di S. Giovanni*, i. (1594), pt. ii. 45 ff.

Later historians of the Order, Boissat,<sup>1</sup> Marulli,<sup>2</sup> Vertot,<sup>3</sup> and Paoli,<sup>4</sup> draw largely, if not exclusively, on this account. The traveller de Brèves gives a slightly different version, making the gallant deed of de Gozon not the cause of his degradation but an attempt to rehabilitate himself.<sup>5</sup>

The characteristic points of the dragon-legend related of de Gozon are: (1) the difficulty of obtaining permission to fight the dragon, and (2) the training of the dogs with a dummy dragon. These are, so far as I know, peculiar to the de Gozon-legend and that of Sire Gilles de Chin, of which the details in question have been shewn to be of seventeenth century origin and therefore probably derived from the de Gozon legend.<sup>6</sup>

## 2.—TANGIBLE EVIDENCE.

Down to quite recent times writers of otherwise unimpeached sanity have laboured to prove that de Gozon's exploit was, at least in essentials, historical. A certain amount of tangible corroborative evidence has been brought forward to this end, but none of it bears examination.

(1) The cave in which the dragon lived was shewn in Rhodes.<sup>7</sup> Such evidence is fairly easy to find. We may here note the possible contribution to the legend afforded by the existence in the early part of the fifteenth century of a rich Rhodian, apparently not a knight, named (or nicknamed) *Il Dracone*, who had a villa and garden at some distance from the city.<sup>8</sup> In Greek lands old proprietors' names are very apt to cling to their

<sup>1</sup> *Histoire de l'Ordre de Saint Jean* (Lyon, 1612), 120 ff.

<sup>2</sup> *Vite de' Gran Maestri della S. Religione di S. Giovanni* (1636), 300 ff.

<sup>3</sup> *Codice Diplomatico del Ordine Gerosolimitana* (1733-37) ii. 464: Paoli is the first to associate the legend of de Gozon with that of Phorbas, as does in our own times C. Torr (*Rhodes in Modern Times*, 94).

<sup>4</sup> *Histoire des Chevaliers de S. Jean* (1726) ii. 22.

<sup>5</sup> *Voyages* (1628), 18: this is curiously paralleled by a western type of dragon-legend in which the hero is a condemned criminal or a deserter (cf. Salverte, *Sciences Occultes*, 3 ed. 377).

<sup>6</sup> C. Liégeois, *Gilles de Chin, l'histoire et la légende* (1903), 108. Supernatural dogs are introduced in some folk-stories of the dragon-fight (cf. Hartland, *Perseus*, i. 29 f.) as assistants of the hero, but their setting and importance are wholly different.

<sup>7</sup> Michaud, *Correspondance d'Orient*, iv. 20; A. Berg, *Die Insel Rhodus*, 80; Biliotti, *Rhodes*, 152; Belabre, *Rhodes of the Knights*, 185.

<sup>8</sup> *Viaggio* (1413) of Niccolò d'Este (*Coll. di Opere della R. Commissione per Testi di Lingua*, i. (Bologna, 1861) 115, cf. 142. 'Il Dracone' was in all probability identical with Dragonetto Clavelli, a Rhodian gentleman who acted as *procuratore* for the Grand Master in 1392 and held lands from the Order (Bosio, ii. 145 (1392), 161 (1402)).

estates, and a place originally named after *Il Dracone*, would afford plausible evidence to later generations for the location of a dragon-fight.

Palerne, in the early years of the seventeenth century, seems to be the first traveller who claims to have seen the cave of the dragon; he adds that 'the story [of de Gozon's exploit] was engraved in the rock.'<sup>1</sup> In this detail he is confirmed a hundred years later by Egmont and Heyman,<sup>2</sup> who give the text of the inscription as follows:—

*FR. DEODATUS DE GAZONE* [sic] *hic anguem immensae molis, orbibus terribilem, miseris Rhodi incolas devorantem, strenue peremit, deinceps magister creatus est* A.C. 1349.

Subsequent writers do not mention this inscription.

(2) For the alleged representation of the combat and the words DRACONIS EXTINCTOR on the tomb of de Gozon at Rhodes our only authority is Bosio,<sup>3</sup> who in all probability was never in the island, since in his time the seat of the Order had been removed to Malta. Vertot, who was in the same case, gives the epitaph in French, *CY GIST LE VAINQUEUR DU DRAGON*, adding that this was the only inscription.<sup>4</sup> A fragment of a supposed tomb of de Gozon was discovered by Rottiers, at a church of S. Stephen outside the city.<sup>5</sup> But the inscription, so far from mentioning the dragon, does not contain the name of de Gozon and the date is a year out.

A genuine sarcophagus of de Gozon was removed from Rhodes to France in 1877, and is now in the Cluny Museum.<sup>6</sup> It is very plain and bears the mutilated legend:—

*Cy gist Fr. Dieudonné d'e Gozon maistre de l'Ospital . . . [qui trespassa] l'an MCCCLIII à viij jors de Dese[mbre] . . .*

(3) Rottiers claimed to have discovered in a private house in the Street of the Knights at Rhodes a fresco representing the combat with the dragon. To judge from the drawing made by his artist the fresco

<sup>1</sup> *Pègrinations* (1606), 347.

<sup>2</sup> *Travels* (1759), i. 277.

<sup>3</sup> *Op. cit.* 55.

<sup>4</sup> *Op. cit.* ii. 54: the same epitaph is given by Paoli.

<sup>5</sup> *Monuments de Rhodes* (1828), 340 and Pl. LII.

<sup>6</sup> *Catalogue du Musée des Thermes*, p. 40, No. 422: the sarcophagus is illustrated in *L'Illustration*, 1878 (lxxi), No. 1826 (Feb. 23). The drawing of de Gozon's tomb in de Villeneuve-Bargemont's *Monuments des Grands Maîtres* (i. Pl. XXVI.) is of course quite fanciful.

like most of the buildings in the street, is much later than the date of de Gozon.<sup>1</sup>

An earlier fresco illustrated<sup>2</sup> by the same author was seen by him in a vault of the ruined church of Notre Dame de Philermes, built, to judge by the arms on the corbels, by the Grand Master d'Aubusson, the hero of the first siege of Rhodes (1480). A knight, not de Gozon (as is shewn by his arms), kneels before S. Michael, who spears a monster. Adjoining the group is a rock with a spring of water gushing out, surmounted by a serpent and two doves.<sup>3</sup> Rottiers rightly abstains from associating this fresco with the de Gozon legend. It may nevertheless have been considered locally as confirmatory evidence.

(4) We have further to reckon with a reputed 'dragon-stone' preserved in Bosio's time by the de Gozon family as a relic of their famous ancestor. This is described as a crystal of the size and shape of an olive and of varied colour: it was supposed to have come from the forehead of the Rhodian dragon. The idea of such stones, derived from Pliny and Solinus, was widespread in the Middle Ages<sup>4</sup> and persisted late.<sup>5</sup> The de Gozon stone, like most of its class, was an antidote (on the homoeopathic principle) against poison. Water in which it was placed bubbled violently while absorbing the virtue of the stone, and was afterwards given to patients to drink. A Rhodian knight of the de Gozon family affirmed that he had himself seen the remedy administered and a serpent 1½ palms long vomited up by the patient.<sup>6</sup>

(5) A head supposed to be that of the dragon slain by de Gozon was seen by the seventeenth century traveller Thévenot hung up in one of the gateways of Rhodes.<sup>7</sup> There is no mention of this head in Bosio or any

<sup>1</sup> *Monuments de Rhodes*, 239 f. Pl. XXVII.

<sup>2</sup> *Op. cit.* 372 Pl. LXII.

<sup>3</sup> The whole seems to form a pendant to another fresco in the same series representing an attack by a saint on a dragon in a cave surmounted by an owl.

<sup>4</sup> A fourteenth century *Lapidaire*, bearing the name of de Mandeville, tells us (p. 113) that the 'pierre de serpent' or *Dreconcides* 'est engendrée de plusieurs serpents qui joignent leurs têtes et soufflent; elle est noire et porte à son chef une partie de blancheur pâle au milieu de laquelle est une image de serpent; elle vaut contre venin, et garde celui qui la porte de morsure de serpent et de bêtes vénimeuses en telle manière, qu'on peut les prendre en sa main toute nue sans se blesser.' The dragon-stone must be taken from the brain of the monster while it still lived (Conrad von Meigenberg, *Buch der Natur*, ed. Pfeiffer, 444, § 29).

<sup>5</sup> The question of the authenticity of 'dragon-stones' or *escarboucles* is seriously discussed by J. B. Panthot, *Traité des dragons*, Lyon, 1691.

<sup>6</sup> Bosio, *op. cit.* 55.

<sup>7</sup> *Travels*, 117; cf. Veryard, *Choice Remarks* (1701), 331.

earlier writer than Thévenot. Subsequent writers speak of such a head (or heads) in a similar position; it seems to have disappeared in 1839.<sup>1</sup>

This supposed evidence for de Gozon's combat has long been recognised as an instance of the familiar use of 'dragons' (*i.e.* crocodiles) and 'dragons' (crocodiles or whales) heads as charms against the evil eye.<sup>2</sup> The selection of city gateways for the suspension of such charms is again familiar. Gates, like all entrances, are considered critical points, city gates especially so from the strategic point of view.<sup>3</sup> It will be noted that, like all the other tangible evidence of de Gozon's exploit, the dragon's head at Rhodes is first mentioned long after the death of the hero.

We may here incidentally remark that the Turkish dragon-legend current in our own time at Rhodes, the hero of which is a dervish who kills the dragon by inducing it to devour forty asses loaded with quicklime,<sup>4</sup> owes nothing to that of de Gozon in detail and probably arose simply from the 'dragon's' head suspended in the city gate.

<sup>1</sup> Biliotti, *Rhodes*, 150 ff. Cf. Rottiers, 235; Michaud, *Correspondance d'Orient*, iv. 20; Berg, *Rhodus*, 90.

<sup>2</sup> A well-known instance is that of the crocodile of Seville (Elworthy, *Evil Eye*, 214). Others are cited from Marseilles, Lyon, Gimiez, and Ragusa by Salverte (*Sciences Occultes*, 482) and from Verona by Berg (*op. cit.* 90).

<sup>3</sup> For the protection of gates by talismans see Quiclet, *Voyages*, 111 ('Giant's bones' at gate of Belgrade); Hobhouse, *Travels*, ii. 946 (Whale's bones at Seraglio gate, Constantinople); Evliya, *Travels*, ii. 230 (Whale's bones and old arms at gate of Angora); Texier, *Asie Mineure*, Pl. XCVII. (stone balls at gate of Konia); Evliya, *op. cit.* ii. 201 (Mace and bow at gate of Kemakh); Belon, *Observations*, xlii. ('Sword of Roland' at gate of Brusa); Lucas, *Voyage au Levant* (1705), ii. 129 (Gigantic boots and weapons in gateways of khans at Brusa); L. Stephani, *Reise durch einige Gegenden des nördlichen Griechenlandes*, 16 (Giant's boot at gate of Chalcis); Gerlach, *Tagebuch*, 337, Covel, *Diaries*, 217 f. (various charms on gates of Constantinople). The gate of the Knights' Castle at Budrum was protected by the charm-text *Nisi Dominus*, etc. Ali Pasha protected the main-gate of his island-citadel at Yannina by building in the head of an 'Arab' still to be seen there, carved in stone and painted black, and the gate of the fort at Prevesa, taken by the Greeks in the last war, has been similarly protected by a number of painted crosses. For the analogous protection of gates by saints' tombs see Frazer's *Pausanias*, iii. 468. There are excellent Turkish examples at Nicaea, and at Candia in the 'New Gate.' The existence of such saints is doubtless often inferred from that of their supposed bones, arms, or other relics, originally suspended as talismans.

<sup>4</sup> Biliotti, *Rhodes*, 153, from whom Torr, *Rhodes in Modern Times*, 94; for the stratagem we may compare that of the eponymous hero of Cracow, who gave the local dragon food mixed with sulphur, pitch, and wax till it eventually died (Münster's *Cosmographie*, ed. Belleforest, ii. 1781), and the *History of Bel and the Dragon* (vv. 23 ff.) in the Apocrypha. A somewhat similar stratagem occurs in the *Shahnameh* of Firdaousi, where Isfendiari begins operations on a dragon by inducing it to swallow a cart loaded with daggers and other weapons.

## 3.—DRAGON PROCESSIONS.

We come now to discuss the outstanding peculiarity of the de Gozon legend, the incident of the dummy dragon. Bosio's elaborate description is worth quoting in full. 'The dragon,' he says, 'was made of canvas stuffed with tow, of the same size, form, and figure and of the same colours as the beast itself. It was of the size of an ordinary horse. It had the head of a serpent with ears the size and shape of a mule's, covered with a very hard and scaly skin, with a great and frightful mouth armed with very sharp teeth. Its eyes, deeply sunk in the head, glittered like fire and glared with horrible ferocity. It had four legs something like a crocodile's, with paws armed with very hard and sharp talons. From its back rose two wings, not so very large, which were the colour of a dolphin above and scarlet with some spots of yellow below. The body and legs were of the same colour as the wings, the belly red and yellow like the under side of the wings. It had a tail something like a lizard's. It ran with a speed greater than that of the swiftest horse, flapping its wings and making a tremendous noise.' All these minute details come from a man—Bosio or another—who had seen such a mechanical dragon as he describes.

All over France, and apparently also in the Netherlands and Spain, are found traces of mediæval festivals, generally in connection with Rogation processions, in which dragons were an important feature. A figure of a dragon, originally symbolising the Spirit of Evil, was carried or led in procession for three days and then sometimes 'killed' or rendered innocuous in a sort of rough religious play.<sup>1</sup> In these cases the dragon is apt to resume his old folklore connection with water and is often regarded as a haunter of springs, or a river beast, or even identified with notable floods of the local river.<sup>2</sup>

In certain instances the dragon came to be popularly regarded as representing an actual monster subdued by the local saint. At Tarascon, where the procession of the 'tarasque,' or dragon supposed to have given its name to the town, still survives, the mechanical monster formerly used for the procession was of immense size, and was manipulated by a dozen men

<sup>1</sup> For the widespread vogue of these festivals see Salverte, *Sciences Occultes*, 475 ff.; and, for legends of dragon-slaying saints in Western Europe, Douhet, *Dict. des Légendes*, s.v. *Tarasque*, and Cahier, *Caractéristiques des Saints*, s.v. *Dragon*.

<sup>2</sup> For the world-wide connection of dragons with springs and water see Frazer's *Pausanias*, v. 44.

from inside, one of whom opened and shut its jaws: it was baited by persons dressed as knights, and on the third day was made to give three jumps to signify its submission to S. Martha, who here figures as the heroine of the local dragon-legend.<sup>1</sup> Similar dragon-processions or legends existed in many towns of Provence; a mechanical dragon was used at Aix.<sup>2</sup> A 'property' dragon of this sort is surely at the back of Bosio's elaborate description.

#### 4.—DE GOZON AND THE FRENCH SIDE OF THE LEGEND.

De Gozon, as we have said, was of the *langue* of Provence. The ancestral castle of the family in the valley of the Tarn (near Costes, department of Aveyron) still bears their name. A cave in the neighbourhood, called *les Dragonnières*, whence a spring issues, is shewn as the scene of the training of the dogs.<sup>3</sup> It may be that the legend of de Gozon's exploit grew up in his native land and was carried thence to Rhodes. This would explain not only the 'dummy' dragon, by the analogy of the French processional dragons, but the otherwise unnecessary French interlude in the story, which depends ostensibly on the Grand Master's strict prohibition of dragon-hunting—an unusual if not unique feature of the story.

We may possibly detect an etymological basis in the name of Gozon, which might conveniently be connected with the Italian *gozzo* (crop, maw)<sup>4</sup> as expressive of the characteristic of many dragons,<sup>5</sup> or with *gos, gous, gots* (and *gozzone*), Provençal for *dog*, which would explain the introduction of the dogs. But such philological speculations offer more scope for ingenuity than proof, and the point cannot be pressed. The introduction of the dogs is perhaps sufficiently accounted for by the stories retailed to

<sup>1</sup> The 'tarasque' used in the modern procession is shewn in Pl. IX.

<sup>2</sup> See especially J. B. Porte in *Mem. de l'Acad. d'Aix*, iv. (1840), 261-308.

<sup>3</sup> De Gissac in *Congr. Archéol. de France*, xxx (1863-4) 65-70; cf. d'Estourmel, *Voyage en Orient*, i. 165.

<sup>4</sup> It occurs in modern provincial French (Lorraine) as *gosse* (stomach of fatted beasts) with the verb *gossier* (to fatten for market).

<sup>5</sup> The processional dragon of Poitiers was named 'Grand'Gueule' (Salverte, *Sciences Occultes*, 477), that of Rheims 'le Bailla' (*ibid.* 475). Similarly the name of Rabelais' giant Gargantua (originally a folklore figure), as also that of his father 'Grangousier' correspond exactly in sense to *Gozzone* (cf. *testa, testone*, etc.) A stream in the department of Aveyron, which flows through a narrow gorge, is called Gouzou. Gozon may have personified its river as a dragon, as Grenoble does the river Drac (Salverte, *op. cit.* 463).

pilgrims in the fifteenth century concerning the trained dogs kept by the Knights of Rhodes at the Castle of S. Peter (Budrum).<sup>1</sup>

The dragon-slaying of Sire Gilles de Chin, to which we have before alluded, was based on a legendary exploit of the historical hero in the Holy Land during the Crusades. This exploit—the killing of a lion—which possibly derived ultimately from the lion which so often serves as footstool to recumbent sepulchral figures, gradually developed, aided by an allegorical picture, till it eventually became a dragon-legend located in the native country (near Mons) of the hero. In a similar way de Gozon's exploit may have developed at home aided by the family's possession of the dragon-stone, the obvious suitability of the country for dragon-warfare, and, it may be, also by a local dragon-procession regarded as commemorative of an actual dragon fight, till it was finally located at Rhodes, owing to (1) the connection of the de Gozon family with the Rhodian Order of S. John, and (2) the suitably romantic background obtained by the change of scene. The case for the French, as opposed to the Rhodian origin of the legend is considerably strengthened by the date at which the story appears in Rhodes.

Bosio's information as to the 'dragon-stone' in the de Gozon family comes, as he tells us, from a Rhodian knight connected with the family, Giovanni Antonio Foxano. The wonderful story illustrating the peculiar efficacy of the 'dragon-stone' came to Foxano directly from his kinsman Pierre Melac de Gozon, Grand Prior of S. Gilles in Provence, who professed to have been an eyewitness of the incident described. This Pierre Melac de Gozon entered the Order of S. John in 1516, and in 1522 took part in the last defence of Rhodes.<sup>2</sup> Was he responsible for the importation thither of the mythical story current there in 1521 of his ancestor's exploit, or at least for the association of his name with a dragon-legend already current in the island? If so he may also, during his residence in Rhodes, have re-edified his ancestor's tomb and still further commemorated the latter's exploit by the painting seen by Rottiers, and by the inscription at the Cave of the Dragon.

F. W. HASLUCK.

<sup>1</sup> So Torr (*Rhodes in Modern Times*, 93, and *Class. Rev.* i. 79), who suggests that these legends are due to the Greek lions' heads built into the castle, probably as talismans, by the Knights. The dogs are mentioned fairly regularly by fifteenth century pilgrims, e.g. William Wey (1458, *Itinerary*, 94), Joos van Ghistele (1486, *T Voyage*, 334) and later located at Rhodes (Veryard, *op. cit.* 331).

<sup>2</sup> Raybaud, *Hist. des Grands Prieurs de S. Gilles*, ii. 112; he became Grand Prior in 1558.



## THE 'TOMB OF S. POLYCARP' AND THE TOPOGRAPHY OF ANCIENT SMYRNA.

(PLATES X., XI.)

---

THE history and authenticity of the so-called 'tomb of S. Polycarp' at Smyrna have lately formed the subject of a monograph by Père S. Lorenzo of the Order of S. Francis,<sup>1</sup> who claims to have discovered the real church and tomb of S. Polycarp in a vineyard at some distance from the site tacitly accepted hitherto both by the Greek and Latin communities. The first section of the present paper attempts to trace as far as possible the history of the traditional tomb; the second to discuss the antiquity of its traditions, and the value of tradition in general at Smyrna; and the third to establish a point in the topography of ancient Smyrna on evidence arising from, or closely connected with, the former discussions.

### § I.—THE TRADITIONAL TOMB AND ITS HISTORY.

The so-called 'tomb of S. Polycarp' (Pl. X. 1) stands on a spur of the castle-hill immediately adjacent to the stadium where the Saint is said to have suffered martyrdom in 166 A.D.<sup>2</sup> The tomb is Mahomedan in form, a rectangular bier built in masonry, with gables at either end, plastered over, and painted green. Like many other Moslem saints' tombs, it is very large as compared with those of ordinary mortals (which adhere to the proportions of an average man), measuring 3'30 × 1'80 metres. It

<sup>1</sup> *S. Polycarpe et son Tombeau*, Constantinople, 1911.

<sup>2</sup> Eusebius, *Hist. Eccles.* iv. 15, 17. For the date see *Rev. Hist. Rel.* iii. 368-381. I feel bound to insist on the historical character of the Saint lest he should be exposed to misconception. But for known facts the names of S. Polycarp and of his companion S. Boukolos would inevitably brand them as a converted vegetation-god and a converted herd-god respectively.

stands in the open air with cypresses at head and foot. Of the two trees the former is old and well-grown, forming a conspicuous landmark, and to it rags are affixed, in accordance with a well-known custom, by the humble clients of the Saint. Both tomb and cypresses stand in a small enclosed cemetery with a roughly-built hut for the guardian.

A tomb of S. Polycarp at Smyrna is first mentioned in 1622, when the town was visited by the French missionary Père Pacifique. His description is as follows:—

'Au lieu où la Ville était auant qu'estre ruinee,<sup>1</sup> y a vne petite Cabane comme vn hermitage, où loge vn Dernis [*for* Deruis], c'est vn Religieux Turc, & dans cette petite chambrette, y a le Cercueil de Saint Policarpe sans son Corps, il est couuert d'vn drap de couleur brune, & sur vn bout d'iceluy est posée la Mitre Episcopale du Saint qui est faicte en la maniere que j'ay cy dessus descript : . . . elle est d'vne estoffe fort simple, mais ouuragee dessus avec des broderies de fil de cotton a guise de Canetille, le nom de Dieu est escript en Arabe sur le front, *Alla*, elle est doublée dedans comme de taffetas Colombin pasle & passé, elle est vn peu entamee par vn coing, quelqu'vn y en ayant couppé en cachette, les Turcs la tiennent avec reuerence, parce qu'ils disent que saint Polycarp estoit vn Euangeliste de Dieu & amy de leur Prophete Mahomet : il y a encore vne Calotte aupres, qu'on tient estre celle que le saint mettoit sur sa teste, j'ay tenu dans mes mains l'vne & l'autre, ie diray pourtant en passant afin de desabuser ceux qui comme le commun croiroient que cette calotte fust aussi veritablement de saint Policarpe qu'est la Mitre qu'ils ne croyent plus, parce que ie sçay de boñe part que la veritable a esté prise & que celle-cy est supposée, à ce que les Turcs ne s'en aperceussent, & qui *pie furatus est ipse mihi dixit* : celui qui a fait ce pieux larcin me le dit a moy-meme.<sup>2</sup>

It is plain that Père Pacifique regarded the mitre, and presumably the tomb also, as authentic. Stochove, ten years later, makes it abundantly clear that the 'mitre' was no more than a dervish sheikh's cap or *taj*<sup>3</sup> : his account is as follows:—

'Avant que d'entrer dans le chasteau, nostre Janissaire nous mena dans un petit bastiment fait en forme de Chapelle où il nous disoit que Saint Jean Polycarpe estoit enterré, lequel aussi bien parmy les Turcs que parmy les Chrestiens, a la reputation d'avoir esté un Saint personnage. A l'entrée nous vismes un Dervis ou Religieux Turc, lequel nous voyant nous salua honnestement, & nous ayant dict qu'il falloit quitter les souliers, nous mena au lieu où ils disent estre enterré ce Saint. Nous y vismes une Tombe couverte de deux robes, l'une de camelot minime & l'autre de velour vert ; aux pieds il y avoit un baston

<sup>1</sup> *I.e.* among the ruins on the hill below the castle gate ; cf. Le Bruyn, *Voyage*, i. 79, quoted below, p. 90, note 5.

<sup>2</sup> *Voyage de Perse* (Paris, 1631), II f.

<sup>3</sup> The supposed mitre is last mentioned by Duloir (1654) as 'vne vieille Mytre faite selon la figure des nostres, mais d'vne estoffe qui m'est inconnue' (*Voyage*, p. 14).

ferré avec deux pointes, portant au milieu un croissant de Lune, semblable à ceux dont usent des pelerins Mahometains, qui vont visiter le sepulchre de leur prophete à la Mecque; au chevet il y avoit la façon d'une mithre, ayant un rebord avec trois pointes où estoit piqué à l'éguille en caracteres Arabesques, *la Hilla heilla, halla Mahemet resul halla* . . . ; ce que nous fit cognoistre l'erreur des Turcs, & que ces habits, baston, & mithre n'estoient point de ce Saint: mais de quelque malheureux Mahometan. Les Turcs portent un grand respect & une devotion particulière à ce lieu, ils tiennent tousjours quelques lampes allumées et à chaque Vendredy plusieurs y viennent faire leurs prières.<sup>1</sup>

In these, the earliest and most detailed accounts of the tomb and relics of S. Polycarp at Smyrna, there is to an unprejudiced eye no outward trace of anything more than a Turkish saint-cult associated by Christians, to judge by Stochove, as much with S. John<sup>2</sup> as with S. Polycarp. It was probably one of those ambiguous cults organised by the Bektashi dervishes which Christians were encouraged to frequent.<sup>3</sup>

Three notices of the tomb about the middle of the seventeenth century are of special interest<sup>4</sup> as shewing that at this date it passed from Moslem to Christian custody.

Monconys, in 1648, does not mention the dervish guardian. The chapel was 'toute rompue et decouverte' and the only thing to be seen in it was a tomb like that of a Turkish sheikh.<sup>5</sup>

D'Arvieux (1654-6) expressly states that the tomb was in Greek hands:—

'Assez près de l'amphithéâtre [*i.e.* the theatre] sont les restes de l'Église de S. Jean. C'étoit la Cathédrale de Smyrne. Elle paroît avoir été fort grande & accompagnée d'un grand nombre de chapelles. . . . De toutes ces chapelles, il en reste une seule qui est assez entière dans laquelle est un tombeau *bien gardé par des Religieux Grecs*, qu'ils disent être celui de S. Polycarpe.'<sup>6</sup>

Thomas Smith (1665) implies that the tomb and the humble two-roomed 'chapel' that contained it were in Christian hands and kept in some sort of repair:—

<sup>1</sup> *Voyage*, 17 f.

<sup>2</sup> S. John (Baptist) has a recognised standing with Musulmans (cf. *Menassih-el-Hadj*, tr. Bianchi, 36, on the former church of S. John at Damascus). It is he, and not S. Polycarp, who is by them considered 'an evangelist of God.'

<sup>3</sup> Cf. below, pp. 94 foll., on *Ambiguous Sanctuaries and Bektashi propaganda*, especially No. 12. Near the tomb now shown as that of S. Polycarp or 'Youssof Dede' is at least one grave marked as that of a Bektashi dervish by the twelve-sided 'mitre' (*taj*) of the order carved on its headstone. Bektashi mitres embroidered with the confession of faith, like that seen at Smyrna by Pacifique and Stochove, are mentioned by J. P. Brown, *The Dervishes*, 150.

<sup>4</sup> The tomb of Polycarp is mentioned also by Le Bruyn, Spon, Wheler, and Tournefort, none of whose descriptions add anything material to our knowledge of it.

<sup>5</sup> *Journal des Voyages*, i. 423 f.      <sup>6</sup> *Mémoires*, i. 50.

'Sepulchrum *S. Polycarpi*, quod in latere montis versus Euroaustum adhuc conservatur, *Graeci* die festo. . . . solleniter invisunt: situm est in quâdam aediculâ, ecclesiae forte sacello, alii, per quam illuc transeundum est, contiguâ. In hoc monumento instaurando, si ab impressionibus aeriis, si a *Turcis*, si a *Christianis* occidentalibus, qui fragmenta marmoris quasi tot sacras reliquias exinde tollunt, laedatur temereturque, laudabilis illorum collocatur opera, ollâ fictili quoque illic appositâ in quam quisque ferè. . . . illic ductus, pauculos aspros conjicit ut in omne aevum perennet.'<sup>1</sup>

The change of ownership may have been due to the movement against dervish orders and superstitious cults, promoted especially by the Vizir Mahommed Kuprulu and the preacher Vanni Effendi in the latter half of the seventeenth century.<sup>2</sup> D'Arvieux' account is further important as helping to explain the ambiguity of Stochove's 'S. John Polycarp.' It is evident that a group of ruins, located by our authors rather vaguely in the vicinity of the castle-gate and the theatre, had for long been regarded as the remains of a great cathedral church dedicated to S. John.<sup>3</sup> The tomb and chapel of 'S. Polycarp' or 'S. John Polycarp' were included in this group of ruins, but their exact position is nowhere exactly indicated.

Pococke (1739) is the first author to refer clearly to the present 'tomb of Polycarp,' which he locates accurately at the north-west corner of the stadium, that is, with at least the length of the latter between it and the ruins known as the 'Church of S. John' (Pl. X.2). To Père S. Lorenzo belongs the credit of having first recognised this change of site. It seems at least probable that the traditional tomb of Polycarp moved from one end of the stadium to the other about the beginning of the eighteenth century,<sup>4</sup> and passed once more into Moslem hands. How this happened, whether, for example, the Turks stole the sarcophagus, or set up a rival tomb

<sup>1</sup> *Notitia Septem Ecclesiarum* (Utrecht, 1694), 53.

<sup>2</sup> Especially under Mahommed IV. (1648-87), see d'Ohsson, *Tableau*, ii. 311; Ubicini, *Turquie*, i. 110; and of the older writers Rycaut, *Present State*, 65 (cf. Hammer-Hellert, *Hist. Emp. Ott.* xi. 250); d'Arvieux, iv. 559; Guilletière, *Athènes*, 225; cf. Tournefort, Letter xiv., who ascribes the movement to Mourad IV. It would seem to have discriminated against the Bektashi (cf. Jacob, *Beiträge zur Bektaschis*, 15, and Rycaut, *op. cit.* 67), and may not improbably be connected with the attempts of Sultans Osman III. (1617-21) and Ibrahim (1640-48), to restrict the power of the Janissaries (see Poulet, *Voyage*, i. 307) who were backed by the Bektashi sect.

<sup>3</sup> See below, § 3.

<sup>4</sup> Such a change of site is by no means unprecedented. The tomb of S. Antipas at Pergamon, which was supposed in the thirties to be in the mosque called S. Sophia (C. B. Elliott, *Travels*, ii. 127), is now shown outside the so-called 'Church of S. John' (Lambakis, *Ἐρρά Ἀστέρες*, 284). Here again the Turks probably made difficulties for Christians entering the mosque.

independently, we shall probably never know. The former is rather suggested by Pococke's account, which runs as follows:—

'It is said that great disorders had been committed here by the Greeks at the time of his [Polycarp's] festival; and that a *cadi* laid hold on this pretence to get money, ordering that, in case any Christians came to it, the community of Christians should be obliged to pay such a sum; but as he could not obtain his end, he put up a stone turban on it, as if it were the tomb of some Mahometan saint, by which he thought to have his revenge in preventing the Christians from ever resorting to it again, which hitherto has had its effect.'<sup>1</sup>

The *cadi's* action may have kept the Greeks away from the tomb for a time and officially; but a century of tradition, aided doubtless by the natural cupidity of the guardian, eventually overrode all artificial obstacles and down to our own day both Greeks and Latins have connected the tomb with the name of Polycarp and frequented it. At the same time the site of the 'Chapel' seems to have been the scene of the official Greek service down to quite a late date. Stephan Schulz in 1753 speaks of the old two-roomed chapel as the church of S. Polycarp,<sup>2</sup> and Prokesch in 1830 says that service was celebrated within living memory in an adjacent building bearing the same name.<sup>3</sup>

Our deductions as to the history of the traditional tomb are therefore somewhat as follows. As early as 1622 an empty sarcophagus<sup>4</sup> inside a humble building was associated with S. Polycarp and revered by Greeks and Turks alike: the tomb was Mahommedan in form, and in charge of a dervish. About the middle of the seventeenth century it passed into Christian hands. In the eighteenth the sarcophagus seems to have been removed, or at least the cult transferred by the Turks to the site of the present tomb, while the supposed chapel continued to be revered by Christians. The prestige of the sarcophagus made the outwardly Turkish tomb still an object of reverence for Greeks, who were encouraged from interested motives by the custodian.

Christian popular tradition still associates the tomb with S. Polycarp, though the Greek service in his honour is now celebrated in the stadium,

<sup>1</sup> *Descr. of the East*, II, 86. The whole story may, of course, be a fable to account for the Mahommedan form of the alleged Christian saint's tomb.

<sup>2</sup> *Reise*, in Paulus' *Sammlung der Reisen* (1801), vi. 105; Weber, commenting on this passage (in Steinwald, *Evang. Gemeinde zu Smyrna*, 30) identifies the 'Chapel of S. Polycarp' with substructures of the stadium recently removed.

<sup>3</sup> *Denkwürdigkeiten*, i. 520, quoted below, § 3.

<sup>4</sup> *Sans son corps* (Pacifique).

and Latin tradition, in consequence of Père S. Lorenzo's recent discoveries, is focussing on the vineyard site.

It is interesting to note that the Mahommedan side of the cult has created for itself a new cycle of legend, investigated by Père S. Lorenzo. The tomb is for Turks no longer the tomb of Polycarp, the 'friend of Mahommed,' but of Youssouf Dede, a Moslem warrior who fell before the castle-walls and carried his head to the 'tomb of Polycarp.'<sup>1</sup> Both traditions were till recently reconciled by the guardian, who showed a bare spot of ground near the tomb as the burial-place of the Christian Saint.<sup>2</sup> The spot where Youssouf fell, before the gates of the castle, is marked by a recent but promising precinct containing a young cypress and a thorn-bush, but as yet no formal tomb, only a heap of stones.<sup>3</sup> This is said to mark the spot where the Saint's head is buried. It is instructive to remark that the negro village on the castle-hill, of which Youssouf has become the tutelary Saint, is of recent immigrants: it is hence apparently that the new religious impetus has come, which has swept the old tomb of Polycarp into its orbit. A dream come true, a prayer fulfilled, or some such accidental happening, is probably accountable. It is also to be noticed in view of 'survival' theories based on the coincidence of festivals, that the festival of Youssouf is celebrated in June<sup>4</sup> and that of his predecessor Polycarp in February.

## § 2.—THE VALUE OF TRADITION AT SMYRNA.

A reputed tomb of S. Polycarp, probably, as we have seen, not always at the same site, has thus been shewn at Smyrna for nearly three centuries, that is, throughout the modern history of the town. The validity or otherwise of its claims to earlier traditions can only be conjectured from general probabilities. It is not safe to attach overmuch weight to

<sup>1</sup> Saints who carried their own heads are common in Turkish as in Christian hagiology; for examples see *Wiss. Mitth. aus Bosnien*, i. 462; Evliya, *Travels*, tr. von Hammer, I, 68, ii. 228. Durham, *Burden of Balkans*, 228; Patsch, *Berat*, 11. The theme affords a convenient explanation for the existence of two tombs attributed to the same saint.

<sup>2</sup> The spot formerly shewn is now covered by the guardian's cottage (S. Lorenzo, 205).

<sup>3</sup> The custom of throwing stones on graves, noticed in Asia Minor also by Schaffer, (*Cilicia*, 29; cf. Bent, *J. R. Anthr. Inst.* xx. 275), is in Herzegovina restricted to the graves of persons who have met their death by violence (*Wiss. Mitth. aus Bosnien*, viii. 273). It may have arisen from a desire to hold down the uneasy ghost.

<sup>4</sup> S. Lorenzo, 202.

'tradition,' especially at Smyrna. In such identifications as that of the tomb of S. Polycarp we have throughout to remember that irrational speculation, based on dreams and other accidental circumstances, normally plays a large part. Indeed religious tradition in the east is quite as easily manufactured as perpetuated, and varies in the most arbitrary manner, even without an apparent cause, such as a break in the history of a community.

In the case of the tomb of S. Polycarp it is *a priori* extremely unlikely that a tradition has survived even from the Middle Ages. One of the many long blanks in the history of Smyrna extends from the sack of the city by Timour (1402) to the renaissance of the seventeenth century. Our sole glimpse of the city in the intervening period, which is afforded by Cepio's account of the Venetian sack in 1472, shews it as a purely Turkish place.<sup>1</sup>

As to the Middle Ages it is true that Sherif-ed-din, the historian of Timour, says that Smyrna was in his time a place of pilgrimage for Christians,<sup>2</sup> but this need not refer to the cult, still less the traditional grave, of S. Polycarp.<sup>3</sup> Of the cult during the Frankish occupation (1344-1402) the only trace seems to be the fact that all known relics of S. Polycarp can be traced to Malta,<sup>4</sup> the later seat of the Knights of S. John, from whom Timour took Smyrna in 1402: there is thus a possibility that these relics were from Smyrna. In the fairly voluminous literature of the Frankish occupation there is no mention of a tomb, relics, or cult of S. Polycarp. If the relics then existed they were probably preserved in some church within the walls of the Knights' castle beside the harbour which was the only part of the city in the hands of the Christians.

When Smyrna emerges from the obscurity of the Middle Ages, which is not before the early years of the seventeenth century, the names of S. John and S. Polycarp are applied to existing monuments and sites absolutely at random.

The following are associated with S. John:—

(1) A cave (near S. Veneranda, in the neighbourhood of the Jews'

<sup>1</sup> Ap. Sathas, *Mon. Hist. Hell.* vii. 294.

<sup>2</sup> Tr. Pétis de la Croix, iv. 46.

<sup>3</sup> In the thirteenth century an *eikon* of Christ was greatly revered there (*G. Acrop.* 91 B.).

<sup>4</sup> S. Lorenzo, *op. cit.* 285-290. Two late fifteenth-century pilgrims, Joos van Ghistele (*T Voyage* (1485), 335) and Grünemberg (*Pilgerfahrt* (1486), ed. Goldfriedrich, 51) mention the head of S. Polycarp amongst the relics at Rhodes.

cemetery) to which he was said to have retired: this was early appropriated by the *cadi* to serve as a cistern.<sup>1</sup>

(2) A font used by S. John for baptism was shewn on the castle-hill in the middle of the eighteenth century.<sup>2</sup>

(3) The mosque in the castle was by some supposed to be a transformed church of S. John.<sup>3</sup>

(4) The columns of Namazgiah in the Jewish quarter were traditionally said to be those of a church of S. John.<sup>4</sup>

(5) 'A mile from the city' (direction not specified, but not, so far as one can judge, on the castle-hill) were the walls of a church also, according to some, dedicated to S. John.<sup>5</sup>

(6) In spite of the long mediaeval tradition of S. John's burial at Ephesus the 'tradition of the Greeks' in the seventeenth century pointed out his tomb at Smyrna.<sup>6</sup>

With S. Polycarp were similarly associated, besides the tomb which forms the subject of the present paper:—

(1) A 'prison,' apparently near S. Veneranda, but the locality is not exactly indicated.<sup>7</sup>

(2) A tree on the castle-hill, which had grown from the saint's staff.<sup>8</sup>

<sup>1</sup> Stochove, *Voyage*, 20; this is probably the modern *Κρυφία Παναγία*, a chapel in a subterranean watercourse (Oikonomos (1809), *Τὰ Σωζόμενα*, i. 338; Weber in *Jahrbuch des Inst.* xiv. 186 f.).

<sup>2</sup> Schulz (1753), *Reise*, 105.

<sup>3</sup> Le Bruyn, *Voyage* (Paris, 1725) i. 74; Spon, i. 232; Earl of Sandwich, *Voyage*, 308; Schulz, 104. In Arundell's time the same building was said to have been dedicated to the twelve Apostles (*Asia Minor*, ii. 394): it has also been called the church of S. Polycarp (see below). The real dedication may have been to S. Demetrius (as Fontrier, *Rev. Ét. Anc.* ix. 114, basing on *Acta et Diplom.* iv. 52), if, indeed, the building was not, as it has every appearance of being, a mosque from its origin.

<sup>4</sup> Oikonomos, *Τὰ Σωζόμενα*, i. 337: these columns have also been said to belong to (a) a 'Palace of Alexander' (De Burgo, *Viaggio*, i. 461), and (b) the Homereion (*Museum Worsleyanum*, ii. 43).

<sup>5</sup> T. Smith, *Notitia*, 53: 'Franciscani templum nuncupant, forte D. Johanni olim dedicabatur.'

<sup>6</sup> La Boullaye, *Voyages* (1653), 20:—'[S. Jean] estant mort en l'isle de Patmos, les Disciples le transportèrent à Smyrne & l'interrèrent suivant la tradition des Grecs, j'ay veu le lieu.' The author does not mention the tomb of Polycarp, and is probably alluding to it under this name.

<sup>7</sup> De Burgo, *Viaggio*, i. 461: is this Stochove's 'Cave of S. John'?

<sup>8</sup> Des Hayes (1621) *Voyage*, 343: 'Il y a vn arbre que l'on dit estre venu du baston de Saint Polycarpe, Evesque de ce lieu, qu'il planta quand il fut pris pour estre martyrisé.' The tree of S. Polycarp is called by Stochove a terebinth, by Spon (i. 232) a cherry, and by the botanist Tournefort a *micocoulier* or lotus.



(3) The mosque in the castle is said by Oikonomos to have been a church dedicated to S. Polycarp,<sup>1</sup> by others, as we have seen, to S. John or the Apostles.

(4) In 1851 a mutilated statue lying on the ground near the castle was pointed out as that of S. Polycarp.<sup>2</sup>

The wholly speculative nature of the identifications made at Smyrna during the seventeenth and later centuries, is shewn best of all by the variety of 'traditions' current as to the conspicuous group of ruins on the acropolis-hill between the castle-gate and the stadium. Three travellers (d'Arvieux, Thévenot, and de Burgo) call this group of ruins a church of S. John, three others (Le Bruyn, Tournefort, and Lucas<sup>3</sup>) a church of S. Polycarp.<sup>4</sup> The former identification seems certainly old,<sup>5</sup> though probably not authentic. D'Arvieux, as we have noted above,<sup>6</sup> seems to compromise by taking the chapel of S. Polycarp as part of the 'Church of S. John,' as Stochové did by fusing S. John and S. Polycarp into one person.

A seventh authority, Edward Melton (1672), who describes unmistakably a conspicuous portion of the group of ruins,<sup>7</sup> considers it either a church of S. Polycarp or a temple of Janus.<sup>8</sup> Others have called the

<sup>1</sup> Τὰ Σωζόμενα, i. 337:—'Ἐπάνωθεν δὲ τούτου [sc. τοῦ ἀμφιθεάτρου] στέκει καὶ μέρος ἰκανὸν τῆς ἐκκλησίας τοῦ ἁγίου Πολυκάρπου, μεταμορφωθείσης εἰς ἥδη ἔρημον τσαμίον [mosque], ὅπου ἦτο καὶ ὁ τόπος τοῦ μαρτυρίου καὶ ὁ τάφος αὐτοῦ.' The only mosque on the hill was that inside the castle walls, which is marked 'Church of S. Polycarp' in Admiralty charts of 1834.

<sup>2</sup> Walpole, *Ansayrii*, i. 25.

<sup>3</sup> *Voyage fait en 1714*, i. 155.

<sup>4</sup> The distinction may be due to a discrepancy in 'tradition' between Greeks and Armenians: similarly at Ephesus certain ruins are associated by the Armenians with S. John the Divine, by the Greeks with S. Panteleemon, each community holding service there on the appropriate day (Lambakis, *Ἑπτὰ Ἀστέρες*, 284). A church at Angora is similarly associated both with S. Clement and S. John (Perrot, *Souvenirs*, 271), probably for the same reason. At Smyrna the S. John dedication, as more popular, is probably more ancient.

<sup>5</sup> A cathedral church of S. John, outside the precincts of the sea-castle, is mentioned in the Frankish period at Smyrna (1344–1402) by the contemporary *Anon. Romanus* (in Muratori, *Antiq. Ital.* iii. 364):—'Era una chiesa antiquissima, la quale hao nome Santo Ianni. Dicesi che lo biato Santo Ianni la edificò. Questa chiesa fo lo Vescovato de quella Terra, nanti che fosse destrutta la Cittate. . . . Po' la destruttione era rimasta champestre.' This church lay *juxta viam* as one went to the (upper) castle (*Joh. Vitodurani Chronicon*, ed. Eckhart, *Corpus Hist. Med. Aev.* i. 1909).

<sup>6</sup> p. 82.

<sup>7</sup> *Zee- und Landreyzen*, 232: 'Van de twee zijden gelijk als in Kapellen door. Kleine muurtjens, die noch over eind staan, afgescheiden zijn,' cf. below, § 3.

<sup>8</sup> Tavernier's church of S. Polycarp near the sea, otherwise called the temple of Janus (*Voyages*, London, 1678, 32), is probably a confusion with the above identification: his description is almost exactly Melton's. The building generally known as the temple

same ruin a 'Judicatorium,'<sup>1</sup> a 'Homereion,'<sup>2</sup> the 'Palazzo del Consiglio,'<sup>3</sup> and the 'Room of the Synod.'<sup>4</sup> Drummond (1744) doubts whether to call it a Homereion, a public library, or a temple of Janus. Prokesch (1830) accepts it as a church of Polycarp.

Seventeenth-century classical archaeology at Smyrna, probably initiated by William Petty in 1634,<sup>5</sup> is in the same empiric stage. The celebrated bust at the castle-gate figures in various authors as (1) Helen of Troy,<sup>6</sup> (2) Semiramis,<sup>7</sup> (3) the Amazon Smyrna,<sup>8</sup> and (4) Apollo,<sup>9</sup> not to mention (5) the Turkish legendary heroine Coidasa,<sup>10</sup> or Katifé.<sup>11</sup>

It is apparent that the identifications made during this period, religious and secular alike, are simple guess-work, varying with the guide's fancy, and resting on no tradition inherited from the Middle Ages. The identification of the ruin or group of ruins called the church of S. John is the only one which is known to date from mediaeval times.<sup>12</sup>

### § 3.—THE RUINS ON THE CASTLE-HILL.

We turn now to examine the ruins near the castle-gate and the theatre. The general position of this group of ruins is made certain by a consensus of seventeenth century authors of whom de Burgo and Tournefort are the clearest.<sup>13</sup> The ruins included (1) the so-called chapel

of Janus (Duloir, 15; La Boullaye, 20; Spon, i. 234; Le Bruyn, i. 79, etc.) and figured in Wheler's cut, stood on the low ground north of the city. Spon called it a Homereion, and Stochove apparently a temple of Diana. Its identity seems to have been fixed (Le Bruyn, i. 79) by the discovery of a 'statue of Janus,' probably a double herm. It may still be doubted whether the building was more than a Turkish *turbe* built of old blocks.

<sup>1</sup> T. Smith.

<sup>2</sup> Rycaut, *Gk. Church*, 41; Drummond (1744), *Travels*, 116.

<sup>3</sup> Gemelli Careri (1693), *Giro del Mondo*, i. 218.

<sup>4</sup> Pococke.

<sup>5</sup> Michaelis, *Ancient Marbles*, II.

<sup>6</sup> F. Arnaud (1602), in *Florilegium de Vogue*, 471; Stochove.

<sup>7</sup> Le Bruyn, Spon.

<sup>8</sup> Tournefort, Pococke.

<sup>9</sup> Monconys.

<sup>10</sup> Rycaut, *Greek Church*, 39.

<sup>11</sup> Carnoy et Nicolaïdes, *Folklore de Constantinople*, 16 ff.

<sup>12</sup> The modern identification of ruins recently discovered in the vineyard by Père S. Lorenzo thus falls to the ground in so far as it is based on the travellers' reports I have attempted to summarise. The ruins themselves are indeterminate, and the supposed tombstone of S. Pionius (S. Lorenzo, 315) no more than a portion of a granite bench inscribed (not ΠΗΝΗV but) -AHNH: it is possibly from a tomb-exedra put under the protection of Sipyrene (cf. *C.I.G.* 3385-7 incl.).

<sup>13</sup> The former places them 200 paces from the castle (i. 460) and 100 from the 'amphitheatre' (i. 461).

of S. Polycarp, a building of no pretensions, containing two compartments, and (2) near this and south-east of it<sup>1</sup> the conspicuous ruin shown in Le Bruyn's plate<sup>2</sup> as a large arch or apse flanked by tower-like projections. By some authors both these buildings are considered as parts of the cathedral of S. John,<sup>3</sup> while by others the second is regarded as a separate building and called by many names, of which, as distinctive, we shall adopt that of 'Judicorium.'<sup>4</sup>

The whole group of ruins seems to have been a good deal excavated by amateurs<sup>5</sup> and finally used as a quarry by the Turks in the latter half of the seventeenth century for the building of Sanjak Kale (1656) and certain mosques.<sup>6</sup> But considerable remains, especially of the 'Judicorium,' existed into the early part of the nineteenth century and are perhaps indicated in Storari's map<sup>7</sup> (c. 1855).

As regards the 'Judicorium' we are well documented. Besides Le Bruyn's drawing we have a contemporary description by Smith, a plan by Drummond, and detailed notes by Pococke and Prokesch.

Smith's account is as follows:—

'[Prope sepulchrum Polycarpi extat] saxeum aedificium, quod judicorium fuisse videtur, tria conclavia habens eodem solo insistentia, quorum medium duodecim fere ab omni latere passuum est. Frontispicium ipsius ornarunt quatuor columnae quarum solae bases manent.'<sup>8</sup>

Pococke says of it:—

['There is a tradition that the cathedral church was built on the north side of the circus, which seems probable, there being some ruins which look like remains of such a building;] and to the south-east of it there is a fabric of three rooms, which had a portico before it, the pillars of which are taken

<sup>1</sup> Pococke.

<sup>2</sup> Reproduced in Pl. XI.

<sup>3</sup> Certainly d'Arvieux (followed by Thévenot) and Prokesch (quoted below).

<sup>4</sup> Above, §, 2, p. 89.

<sup>5</sup> Le Bruyn, i. 79:—'A une petite lieue de la Ville, en allant vers le Château, on trouve, à ce que l'on croit, l'endroit où étoit l'ancienne Smyrne [cf. Pacifique, quoted above, § 2 *ad inii.*]; on y voit encore quelques restes d'antiquité. C'est autour de là qu'on trouve sous terre la plupart des statués comme il arriva dans le temps que je demourois à Constantinople' [here follows an account of four statues sent to the French king, probably those mentioned in Gronovius, *Mem. Cosson.* 36]. For other digging in this neighbourhood about the same period, see Galland's *Journal*, ii. 214 (1673), and cf. Omont, *Miss. Archéol.* i. 209 (1680).

<sup>6</sup> Cf. G. de Burgo (1686), i. 460:—'della gran chiesa di S. Gio. Apostolo non resta altro che le fondamenta, havendo gli Turchi portate via le pietre per fabricare li castelli alla marina sicome anche alcune Moschee.'

<sup>7</sup> Reproduced in Pl. X. 2.

<sup>8</sup> *Notitia*, 53 f.

away. . . . probably the synod-room of the archbishop, whose house might have been between this and the church.'<sup>1</sup>

By far the clearest account of the building is Drummond's, who, though in doubt what to call it, took the trouble to secure a plan and measurements. The building is divided into three parallel compartments, communicating with each other by doorways in the party-walls. The whole was prefaced by a portico of four columns *in antis* (all missing). The central of the three compartments opened on the porch by a doorway, the others by windows. The dimensions of the building 'within the walls' was 50 × 27 feet, of the 'temple' 16 × 27 feet, and of the 'cloister' 13 × 27 feet. The main entrance was 12 feet wide, the side doors 3½, and the windows 3 feet. The walls were 4 feet thick.<sup>2</sup> There are some discrepancies in these measurements, but the general idea is given by the plan (Pl. X. 3).

Prokesch's account of the same building, under the name of 'Chapel of S. Polycarp' shews that it did not suffer materially in the next hundred years:—

'[Das Kirchlein des Heiligen Polycarpus] hoch auf dem westlichen Abfal des Schlossberges gelegenist. Noch leben Viele die sich des Gottesdienstes darin erinnern. Es bestand aus drei Räumen, länglich und klein, finster und enge, voll Nischen und Gewölben, und war aus Granitblocken des Schlosses gebaut worden. In der linken Capelle soll der Predigtstuhl, in der mittleren ein Gnadenbild gestanden haben. Der Eingang ging durch einen von Säulen getragenen, bedeckten Vorhof. Die Säulen sind verschwunden, aber die Bogen greifen noch aus den Mauern vor.'<sup>3</sup>

From all these descriptions we gather a perfectly clear idea of the plan of the building. As to the elevation, for which Le Bruyn's drawing is our only source, we can only be certain that the central compartment was higher than the others. This arrangement, as suggesting a nave and aisles, has led to the supposition that the building was a church. Nothing in the

<sup>1</sup> *Descr. of the East*, ii.<sup>2</sup>, 36. The Earl of Sandwich (*Voyage*, 308) makes the relative positions of the buildings rather clearer: 'Descending this hill [from the castle] on the south-west side you discover an ancient building of squared stones very well cemented together, vulgarly called Homer's School [*i.e.* our 'Judicarium'] . . . a little lower is a small chapel dedicated to S. Polycarp, whose sepulchre is to be seen at a small distance from it. . . . Near this chapel are the remains of a stadium.'

<sup>2</sup> *Travels* (London, 1754), 116 f. (plan faces p. 115).

<sup>3</sup> *Denkwürdigkeiten*, i. 520; see also *Jahrb. f. Litteratur* (Vienna) lxxvii. (1834), *Anzeigerbl.* 62. The last vestiges of this building are marked on Storari's Plan of Smyrna (1855) as *Ruine*, between the castle gate and the south-east end of the stadium. Fontrier (*Rev. Ét. Anc.* ix. 114) says that this site is now occupied by a vineyard in which stone water-pipes have been found. The vineyard mentioned is the site of Père S. Lorenzo's supposed church and tomb of S. Polycarp.

plan, however, warrants that supposition: the absence of an apse is conclusive against it. The position, moreover, outside the mediaeval citadel and at the same time remote from the port, is not a likely one for a cathedral. All the buildings in this direction seem to belong to ancient, not to mediaeval, Smyrna.

It is further evident that our seventeenth century authorities saw their 'church of S. John' in a great complex of ruined building, of which the 'Judicorium,' if included at all, is but a portion. De Burgo, for instance, gives the dimensions of the 'church of S. John' as 158 × 30 paces<sup>1</sup> or nearly as large as the court of the great mosque at Damascus. Smith's 'chapel of S. Polycarp' is joined to the *Judicorium* by a 'long series of vaults set in a row,' evidently interpreted by some as the remains of the great church. Another interpretation is possible.

The late Dr. Weber, in his minute and learned study of the aqueducts of Smyrna, traces the 'high-pressure' aqueduct of Kara-Bounar step by step up to the very saddle of the castle-hill where the 'Judicorium' stood.<sup>2</sup> I have myself seen stone pipes from it hereabouts (in the vineyard of Père S. Lorenzo's discoveries),<sup>3</sup> and in recent times there has come to light at some spot on the castle-hill an inscription<sup>4</sup> duplicating *C.I.G.* 3147 and recording repairs early in the reign of Hadrian to an aqueduct known from *C.I.G.* 3146 to have been built about 80 A.D.<sup>5</sup> The exact provenance of *C.I.G.* 3146, 3147, is unknown, but the finding of the second copy of the latter on the castle-hill is strong evidence for connecting all three, not (as Dr. Weber)<sup>6</sup> with the lower (Ak-Bunar), but with the upper (Kara-Bounar) aqueduct. Dr. Weber found no trace of any aqueduct within the walls of the fortress, but odd blocks of stone piping, apparently from the Kara-Bounar aqueduct, have been discovered near the theatre, and in the Upper Quarter of the Greeks,<sup>7</sup> both on the slopes of the castle-hill.

<sup>1</sup> *Viaggio*, i. 461.

<sup>2</sup> *Jahrbuch*, xiv. 4 ff.

<sup>3</sup> Cf. Fontrier, *Rev. Ét. Anc.* ix. 114, cited above.

<sup>4</sup> Μουσεῖον καὶ Βιβλιοθήκη, 1880, 139 (181), now in the Greek Museum at Smyrna:—Τραιανοῦ | ὕδατος ἀποκαταστάθηντος | ὑπὸ Βασιλεῦς Τούτλου ἀνθυπάρχου. The text is a duplicate of *C.I.G.* 3147 = Dittenberger, *Oriental. Gr. Inscr.* 478, now at Trinity College, Cambridge. For the date see Weber, *loc. cit.* 174.

<sup>5</sup> For this date see Weber, *loc. cit.*, and Dittenberger, *Oriental. Gr. Inscr.* 477. Smith found a dedication to Hadrian built into the 'chapel of S. Polycarp.'

<sup>6</sup> *Jahrbuch*, xiv. 167, 174. Dr. Weber seems to have been biassed by his opinion that the temple of Zeus Akraios stood on 'Windmill Hill.'

<sup>7</sup> Weber, *loc. cit.* 19 f.

It is tempting to suggest that the 'Judicatorium' formed the ornamental terminus of the Kara-Bounar aqueduct or *Aqua Traiana*. The high site on the saddle of the castle-hill was particularly fitted for one of these buildings, generally called *Nymphæa*, which served the double purpose of public fountains and *dividicula* or points for the distribution of water by smaller channels to different parts of a town. The three 'narrow and dark' chambers of the 'Judicatorium' may have been cisterns or settling chambers for the water.

Fine specimens of this class of monument are to be found elsewhere in Asia Minor, at Aspendus, and especially Selge.<sup>1</sup> The 'Exhedra of Herodes' at Olympia is a monument of the same order. If, as is not impossible, such a building stood on the castle-hill at Smyrna, and especially if it formed one end of a public open space such as an *agora*,<sup>2</sup> the mistake of the earlier travellers is readily explained. The *débris* of such a group of buildings, with its colonnades and lines of shops and the triple building at one end, might easily suggest an immense ruined church with a number of fallen side-chapels and the chancel still standing. But excavation alone can turn such conjectures into proof.

F. W. HASLUCK.

<sup>1</sup> Durm, *Baukunst der Römer*, 468 ff.: Lanckoronski, *Pamphylien und Pisidien*, i. Pl. XXX. (Selge).

<sup>2</sup> For an *agora* in a similar position between lower town and citadel we may compare those of Assos and Pergamon. Ramsay (*Seven Churches*, 260, cf. Calder in *Studies in Art*, etc., 104) conjectures that the Golden Street of Smyrna ended in the neighbourhood of our hypothetical *agora*.

## AMBIGUOUS SANCTUARIES AND BEKTASHI PROPAGANDA.

---

THE stratification of cults at famous sanctuaries of the ancient world, reflected for the most part in their local mythology, has long been interpreted as evidence of the invasion of older by newer gods and religious systems. A religion carried by a conquering race or by a missionary priesthood to alien lands superimposes itself, by force or persuasion, on an indigenous cult: the process is expressed in mythological terms under the figure of a personal combat between the rival gods or of the 'reception' of the new god by the old.<sup>1</sup> Eventually either one god or the other succumbs and disappears or is relegated to an inferior position; or, again, the two may be more or less completely identified and fused.

Of the religions of antiquity it is seldom possible to do more than conjecture by what methods and processes these transitions were actually carried out. The paper which follows is an attempt to examine some phenomena of the superimposition of cult in the case of a modern Mahommedan sect—the Bektashi—acting on the sanctuaries of the mixed populations of Turkey and in particular on Christian saint-cults. So far as we can see, where Bektashism has gained ground at the expense of Christianity this has been accomplished without violence, either by processes analogous to that known to the ancient world as the 'reception' of the new god by the old, or simply by the identification of the two personalities. The 'ambiguous' sanctuary, claimed and frequented by both religions, seems to represent a distinct stage of development—the period of equipoise, as it were—in the transition both from Christianity to Bektashism and, in the rare cases where political and other circumstances are favourable, from Bektashism to Christianity.

<sup>1</sup> Of the latter phenomenon the typical case is that of the 'reception' of Asklepios by Amunos at Athens (*Ath. Mitth.* xxi. 307 ff.; Kutsch, *Attische Heilgötter und Heroen*, 12 ff.).

## BEKTASHISM AND ORTHODOX ISLAM.

The Bektashi are best known as an order of dervishes, but, as in other orders, professed dervishes form only the hierarchy of their organisation, the rank and file being laymen (called *mühüb* = 'friend')<sup>1</sup> openly or secretly subscribing to their doctrines: each local congregation finds its normal rallying-point and place of common worship in the nearest Bektashi *tekke*. A *tekke* may, according to circumstances, be a convent containing a number of professed dervishes under a *baba* or abbot, or a kind of 'lodge' inhabited only by the *baba*, as the spiritual head of the local community, and his attendants. It always contains the grave of a saint of the order (often the founder of the *tekke*), and a room (called *meidan*) for common worship. The Bektashi sect is identified with no nation or race, and is widely spread over the old Turkish Empire from Mesopotamia to Albania: its geographical distribution will form the subject of a future paper.

The religious doctrines of the Bektashi are devised to cater for all intellects and all temperaments: their system includes, like other mystic religions, a gradual initiation to secret knowledge by a number of grades: these form a series of steps between a crude and popular religion, in which saint-worship plays an important part, to a very emancipated, and in some respects enlightened, philosophy. The theology of Bektashism ranges from pantheism to atheism. Its doctrine and ritual, so far as the latter is known, have numerous points of contact with *Shia* Mahommedanism, of which it is confessedly an offshoot, and with Christianity, to which it acknowledges itself akin. In theory at least abstinence from violence and charity to all men are inculcated: the good Bektashi should make no distinction in his conduct between Musulmans and non-Musulmans, and members of non-Musulman religions may be admitted to the order. These tenets are so far carried into practice that in the 'fifties of the last century a Greek, by name Antonáki Varsámis, even became president of a local 'lodge' in the Brusa vilayet: he owed his position to the purchase of lands of which the former proprietor (who, from the description given of him, may well have been an Albanian) was a Bektashi of great local

<sup>1</sup> This, the ordinary name for lay adherents of a dervish order, is variously explained as 'Friends of the Family of the Prophet' or 'Friends of the Order.'



importance.<sup>1</sup> In our own day Monseigneur Petit writes of the Albanian Bektashi as follows :—' Parmi les cinquante ou soixante derviches que compte chacun de leurs couvents d'Albanie, une enquête même sommaire découvrirait aisément nombre de Chrétiens à qui on a révélé, comme à des Musulmans authentiques, les secrets de l'ordre, mais sans exiger d'eux le sacrifice de leur foi. Ils assistent aux cérémonies liturgiques, d'ailleurs fort courtes,—cinq ou six minutes par jour—et le reste du temps, ils peuvent, si bon leur semble, remplir leurs devoirs de Chrétiens.'<sup>2</sup>

All candidates for admission to the order must be believers in God and persons of good moral character : this latter must be guaranteed by a satisfactory sponsor.

Bektashism is not hereditary, the son of a Bektashi father being perfectly at liberty to choose, at years of discretion whether or not he will enter the Bektashi order or another.

Orthodox *Sunni* Moslems are scandalised not only by the *Shia* beliefs of the Bektashi, but by their everyday practice. They are notoriously careless of the Prophet's injunctions with regard to circumcision, veiling of women; regular prayer, and abstention from strong drink; the latter freedom undoubtedly tends to swell their ranks with undesirables. Further, their peculiar worship is performed not in a mosque but in a special chapel or oratory (*meidan*), and with closed doors; both sexes take part in the worship. This gives rise to the scandalous suspicions usually entertained of secret religions.

Usurpation of alien sanctuaries seems to have played an important part in the spread of Bektashism from the beginning. In the first place it is now generally recognised that the sect acquired its present name by such an usurpation. The Anatolian saint Hadji Bektash has in reality nothing to do with the doctrines of the sect which bears his name. The real founder of the so-called Bektashi was a Persian mystic named Fadlullah, and the original name of the sect Houroufi. The traditional date—a very doubtful one—of Hadji Bektash's death is 1337–8. Fadlullah died, a martyr to his own gospel, at the hands of one of Timour's sons in 1393–4. Shortly after his death his disciples introduced the Houroufi doctrines to the inmates of the

<sup>1</sup> Macfarlane, *Turkey and its Destiny*, i. 496 f. : the same person, evidently, is mentioned in Lady Blunt's *People of Turkey*, ii. 278.

<sup>2</sup> *Les Confréries Musulmanes*, 17. Mgr. Petit's information on the Bektashi has a special value as coming from the learned Samy Bey Frasherî, an Albanian from a Bektashi district.

convent of Hadji Bektash (near Kirshehr in Asia Minor) as the hidden learning of Hadji Bektash himself, under the shelter of whose name the Houroufi henceforth disseminated their (to orthodox Moslems) heretical and blasphemous doctrines.<sup>1</sup> The heresy continued to spread more or less unnoticed, and the sect acquired considerable political power by its combination with the Janissaries, which was officially recognised at the end of the sixteenth century. Henceforward the Bektashi become more and more suspected of heresy and disloyalty, till at last Mahmoud II. in 1826 made an attempt to destroy at one blow the Janissaries and their dervish backers. By his action the Janissaries were permanently broken, the Bektashi only crippled: by the fifties of the last century they had largely recovered,<sup>2</sup> and at the present day they exercise a considerable secret influence over the laymen affiliated to them, especially in out of the way parts of Asia Minor (Cappadocia, Lycia, and Kurdistan) and in Albania.<sup>3</sup>

In this latter country the Bektashi are said to number as many as 80,000 adherents,<sup>4</sup> and Albanian dervishes are frequently found in convents outside their own country. A recent visitor reports that even at the central *tekke* of Hadji Bektash in the heart of Asia Minor the majority of the dervishes are Albanian:<sup>5</sup> many of these would doubtless be qualifying themselves for the presidency of a *tekke* in their own country.

The methods used by the Bektashi to appropriate the sanctuary of Hadji Bektash were evidently used by them elsewhere for the spread of their gospel. We may suppose that the persons administering tribal and other sanctuaries were won over, probably by more or less complete

<sup>1</sup> Browne in *J. R. Asiat. Soc.* 1907, 535 ff.; G. Jacob, *Beiträge zur Geschichte des Dervischordens der Bektaschi*; cf. Degrand, *Haute Albanie*, 228 ff. for current legends on the subject of the encroachment of the Houroufi on the convent of Hadji Bektash. The Bektashi deny that the Houroufi doctrines are an essential part of their system, but admit that many Houroufi disguised themselves as Bektashi and Mevlevi at the time of their persecution under Timour.

<sup>2</sup> Scarlatos Byzantios (Κωνσταντινούπολις, iii. 496) says that *one-fifth* of the Turkish population of Constantinople was supposed in his time to be Bektashi. For the influence of the sect in western Asia Minor about the same time see MacFarlane, *Turkey and its Destiny*, i. 497 ff. The Bektashi seem to attribute the expansion to the tolerance shewn them by Sultan Abdul Medjid (1839-61).

<sup>3</sup> For Bektashism in Albania see Leake, *N. Greece*, iv. 284; Degrand, *Haute Albanie*, 230; Durham, *Burden of the Balkans*, 208; Brailsford, *Macedonia*, 243 ff.

<sup>4</sup> (Blunt) *People of Turkey*, ii. 277, confirmed to me in Epirus. The whole number of Bektashis is assessed by themselves at 3,000,000.

<sup>5</sup> Prof. White in *Contemporary Review*, Nov. 1913, 694.

initiation into the secret learning of the Bektashi and the increase of power and prestige thereby afforded. The worshippers were satisfied by some apocryphal legend connecting their saint with Hadji Bektash or a saint of his cycle,<sup>1</sup> and probably by an increased output of miracles; the sanctuary with its *clientèle* would be thenceforth affiliated to the Bektashi organisation. In the case of the more or less anonymous and untended saints' tombs or *dedes* such as abound all over Turkey the problem was still simpler. Such saints had only to be induced to reveal their true nature in dreams to Bektashi dervishes, and for the future their graves would be distinguished by Bektashi headdresses.

Crowfoot's researches among the Anatolian *Shia* tribes ('Kyzylbash') of Cappadocia have revealed the process of amalgamation in an intermediate stage.<sup>2</sup> At Haidar-es-Sultan, a *Shia* village near Angora, the eponymous saint Haidar, probably tribal in origin,<sup>3</sup> is identified quite irrationally under Bektashi auspices with Khodja Achmet of Yassi, who figures in Bektashi legend as the spiritual master of Hadji Bektash, or with Karadja Achmet, a saintly prince of Persia, who, though himself probably in origin a tribal saint, has been adopted into the Bektashi cycle.<sup>4</sup> The *tekke* of Haidar-es-Sultan has close relations with the Bektashi.

Similar cases of absorption by the Bektashi could probably be found without difficulty elsewhere. A probable case seems to be the great and rich convent with two hundred dervishes found by Lucas at Yatagan<sup>5</sup> near Denizli (vilayet of Aidin), 'où l'on garde précieusement le corps d'un Mahometan nommé Jatagoundie, que l'on dit avoir opéré de grandes merveilles dans tout le Pais.'<sup>6</sup> Tsakyroglou's list of nomad Turkish tribes includes one named *Yataganli*, which frequents the vilayet of Aidin.<sup>7</sup>

<sup>1</sup> So in ancient Athens the newcomer Asklepios is foisted on the indigenous Amunos on the assumption that both were pupils of Chiron. In the case of Turkish tribal sanctuaries the propagation of such myths would be particularly easy: the tribes dimly remembered their immigration, as squatters and raiders, from the east, while the fictitious cycle of Bektashi tradition represented Hadji Bektash and his companions as immigrant missionaries from the same quarter.

<sup>2</sup> *J. R. Anthr. Inst.* xxx. (1900) 305 ff.

<sup>3</sup> A Tribe of Dersimli ('Kyzylbash') Kurds is called *Haidarli* (*Geog. Journ.* xlv. (1914) 68). The name Haidar ('lion') has a special vogue among Shias, the 'lion of God' being a title of Ali.

<sup>4</sup> On Haidar-es-Sultan see note below, p. 120.

<sup>5</sup> So Arundell, *Asia Minor*, ii. 50.

<sup>6</sup> *Voyage dans la Turquie fait en 1714*, ii. 171.

<sup>7</sup> Περὶ Γλοιοῦκων, 15.

The saint buried at Yatagan was in all probability the eponym of the tribe (Yatagan-Dede?) later adopted, like Haidar, by the Bektashi: the assumption that the convent was in the hands of this order of dervishes is not so wild as it appears, since convents of other Turkish orders are seldom found beyond the outskirts of large towns.<sup>1</sup>

Such absorption of tribal saints, whose cults are often in the hands of more or less illiterate people is comparatively easy. The Bektashi, according to their enemies at least, were quite as successful in ousting rival religious orders. Hadji Bektash himself is generally considered by the orthodox a saint of the Nakshbendi order, and since the suppression of the Bektashi in 1826, an orthodox mosque with a minaret has been built at the central *tekke*, and a Nakshbendi Sheikh quartered on the community for the performance of services in it.<sup>2</sup> Similarly the Nakshbendi claimed that the Bektashi had unscrupulously usurped others of their saints' tombs, including those of Ramazan Baba at Brusa and of the saint buried in the *tekke* of Kasr-el-Ain at Cairo.<sup>3</sup> Such usurpations, if we may believe Assad Effendi, the historian of Sultan Mahmoud's campaign against the Bektashi, were numerous: under the pretext that the titles *baba* and *abdal* denoted exclusively Bektashi saints, the Bektashi appropriated the chapels and sepulchral monuments of all the saints so entitled belonging by right to the Nakshbendi, Kadri, and other orders.<sup>4</sup>

#### BEKTASHISM AND CHRISTIANITY IN ASIA MINOR.

We have thus found evidence of Bektashi encroachments on tribal sanctuaries and on the holy places of other orders. More interesting is

<sup>1</sup> Since writing the above I have ascertained that the *tekke* of Yatagan was one of the Bektashi convents ruined in 1826; it is now insignificant, though the tomb of Yatagan Baba survives.

<sup>2</sup> I have often found a *mesdjid* or oratory in a Bektashi *tekke*, but never a mosque with proper establishment. *Mesdjids* are built for the appearance of orthodoxy and for the accommodation of orthodox visitors.

<sup>3</sup> This saint was identified by the Nakshbendi with a certain Mollah Ainy. The Bektashi seem to have associated the *tekke* with Kaigousouz Sultan, buried in the present Bektashi *tekke* on the Mokattam (see Browne in *J. R. Asiat. Soc.* 1907, 573). The *tekke* of Kasr-el-Ain is said by Wilkinson to have been originally Bektashi (*Modern Egypt*, i. 287). Pococke mentions it (*Descr. of the East*, i. 29) but without stating to which order it belonged in his time. It was transferred by Ibrahim Pasha to the Kadri (Wilkinson, *loc. cit.*) and is now said to be in the hands of the Rufai.

<sup>4</sup> Assad Effendi, *Destruction des Janissaires* (1833), 300. The Albanian Bektashi seem to lay claim to such saints as Shems Tabrizi, Nasr-ed-din Khodja of Akshehr, and Hadji Bairam (founder of the *Bairami* order) of Angora (Degrand, *Haute Albanie*, 230).

their procedure in the case of Christian churches and saints' tombs; they have not only laid claim to Christian sanctuaries, but have also in return thrown open the doors of their own to Christians. This is the more remarkable since Christians in Turkish lands are much less protected by public opinion than are orthodox Moslem sects like the Nakshbendi.

The numerous points of contact between Bektashism and Christianity have been set forth at length by Jacob.<sup>1</sup> The only historical evidence of overt propaganda among Christians is to be found in the accounts of the rebellion of Bedr-ed-din of Simav,<sup>2</sup> in the early years of the fifteenth century, which can hardly have been unconnected with the Bektashi-Houroufi sect, though this is nowhere explicitly stated. The rebellion was partly a religious, partly a social movement: the programme included the Bektashi-Houroufi doctrines of religious fusion and community of goods. An enthusiastic welcome was extended to Christian proselytes and proclamation was made to the effect that any Turk who denied true religion in the Christians was himself irreligious. A special manifesto on these lines, carried by a dervish deputation to a Cretan monk resident in Chios, was successful in winning him to the cause.<sup>3</sup> The pro-Christian tendencies of the rebels were evidently recognised by the Turks in the punishment eventually meted out to their leader, who was crucified.

Liberal theory, however, can have little real hold on the imagination of the masses. For the illiterate, whether Moslem or Christian, doctrine is important mainly as embodying a series of prohibitions: their vital and positive religion is bound up with the cult of the saints, and demands concrete objects of worship, especially graves and relics,<sup>4</sup> and above all

<sup>1</sup> *Die Bektaschijje in ihren Verhältniss zu verwandten Erscheinungen in Abh. d. Philos.-Philol. Klasse d. k. Bayr. Ak. d. Wiss.* xxiv. (1909), iii. Abth. 29 ff.

<sup>2</sup> Ducas, 112 B; Hammer-Hellert, *Hist. Emp. Ott.* ii. 181 ff.

<sup>3</sup> The text is given by Ducas. The leader of the rebels sent to the Cretan saying: 'κἀγὼ συνασκητῆς σου εἰμι, καὶ τῷ θεῷ ᾧ λατρεύεις κἀγὼ τὴν προσκύνησιν φέρω.' With this compare the conduct of the Houroufi dervish, met in Chios about the same time by George of Hungary, who 'intra bat ecclesiam Christianam et signabat se signo crucis et aspergebat se aqua benedicta et dicebat manifeste uestra lex est ita bona sicut nostra est' (*De Ritu Turcorum*, cap. xx.).

<sup>4</sup> The enormous potency of graves and buried saints in popular religion is pointed out in regard to the Holy Places of Islam by Burckhardt. Though the visit to the Prophet's tomb at Medina is optional and the pilgrimage to the Kaaba at Mecca obligatory, the tomb of the Prophet inspires the people of Medina with much more respect than the Kaaba does those at Mecca, visitors crowd with more zeal and eagerness to the former shrine than the latter, and more decorum is observed in its precincts. At Mecca itself men will swear lightly by the Kaaba, but not by the grave of Abou Taleb (*Arabia*, i. 235, ii. 195, 197).

miracles, to sustain its faith. It is in the cult of the saints that the Bektashi propaganda amongst Christians has left most trace. The lines adopted are identical with or parallel to those followed, according to the theory propounded elsewhere,<sup>1</sup> by the Mevlevi order of dervishes at Konia in the Middle Ages for a similar purpose. On the one hand Moslem sanctuaries are made 'ambiguous,' or accessible to Christians also, by the circulation of legends to the effect (1) that a saint worshipped by Moslems as a Moslem was secretly converted to Christianity, or (2) that the Moslem saint's mausoleum is shared by a Christian. On the other hand, Christian sanctuaries are made accessible to Moslems by (3) the identification of the Christian saint with a Moslem. These three schemes may be called for brevity 'conversion,' 'intrusion,' and 'identification': for the latter process use is often made on the Moslem side of a somewhat vague personage—at Konia Plato—as a 'lay-figure' capable of assimilation to various Christian saints.

In Turkey, particularly in parts where the average peasant intelligence and general culture are of a low order and the difference between Christian and Moslem is not acutely felt, it is usual for any sanctuary reputed for its miracles to be frequented by both religions.<sup>2</sup> The 'conversion,' 'intrusion,' and 'identification' schemes are devised to accentuate this natural point of contact between the two religions and to put it on a logical footing. The idea of metempsychosis, which is often implied by 'identification,' though foreign to orthodox Christian thought, is widely current in the *Shia* forms of Islam.<sup>3</sup>

For Asia Minor the 'lay-figure' saint of the Bektashi is possibly the protean Khidr. Khidr is revered in a vague way by all Moslems, who often identify him with S. George. He has a special prominence among the 'Kyzylbash' of Asia Minor,<sup>4</sup> whose connection with the Bektashi is obscure but well authenticated. The 'Kyzylbash' Kurds of the Dersim recognise the Armenian saint Sergius as identical with Khidr<sup>5</sup> and make

<sup>1</sup> *B.S.A.* xix. 191 ff.

<sup>2</sup> In this assimilation language is an important factor. The phenomena here mentioned occur markedly in Central Asia Minor where all races speak Turkish, and in Albania where all religions speak Albanian.

<sup>3</sup> The Persian Shah Abbas held firmly that Ali, S. George, and S. James of Compostella were identical (*P. della Valle, Viaggio*, ii. 257 f.).

<sup>4</sup> White, *Trans. Vict. Inst.* xxxix. (1907) 156; cf. Jerphanion in *Byz. Zeit.* xx. 49 3. The same is true of the Nosairi (*R. Dussaud, Religion des Nosairis*, 128-135).

<sup>5</sup> Grenard, *Journ. Soc. Asiat.* iii. (1904) 518.

pilgrimage to Armenian churches of S. Sergius as to sanctuaries of Khidr.<sup>1</sup> Further west, among Greek populations who hold S. Sergius of less importance than do the Armenians, the connection generally admitted by Moslems between Khidr and S. George and S. Elias has probably served its turn. At the *tekke* of Sheikh Elwan in Pontus Khidr seems certainly to have supplanted S. Theodore,<sup>2</sup> who, as a cavalier and a dragon-slayer, approximates to S. George. Though we cannot as yet definitely ascribe to the Bektashi this transference from Christianity to Islam, the locality falls well within the range of their influence.

The more ignorant the populations concerned, the further such identifications can be pressed. The 'Kyzylbash' Kurds, who possess in all probability a strong admixture of Armenian blood, equate Ali to Christ, the Twelve Imams to the Twelve Apostles, and Hassan and Hussein to SS. Peter and Paul.<sup>3</sup> The conversion of illiterate Christians, always aided by material attractions, becomes fatally easy under the influences of this accommodating form of Islam.

Apparent examples of such religious fusion under Bektashi auspices are to be found in the following Anatolian cults.

#### 1.—*Hadji Bektash Tekke, near Kirshehr.*

This, the central *tekke* of the Bektashi order, is frequented by Christians, who claim that the site was once occupied by a Christian monastery of S. Charalambos.<sup>4</sup> On entering the mausoleum (*turbe*) where Hadji Bektash lies buried Christians make the sign of the cross: they are said to identify the tomb with that of S. Charalambos,<sup>5</sup> who, however, has no connection with Cappadocia. The identification has probably grown up owing to some legendary intervention of Hadji Bektash at a time of plague, such intervention being characteristic of S. Charalambos.<sup>6</sup> That the identification is not of great antiquity<sup>7</sup> seems proved by the account of the archbishop Cyril (1815), who equates Hadji Bektash

<sup>1</sup> Molyneux Seel, *Geog. Journ.* xlv. (1914) 66. The Armenians are said to confuse SS. Sergius and George (P. della Valle, *Viaggio*, ii. 253).

<sup>2</sup> Anderson, *Studia Pontica*, i. 9 ff.; cf. iii. 207 ff. See further Grégoire, *Byz. Zeit.* xix. 59-61; Jerphanion, *ibid.* xx. 492.

<sup>3</sup> Molyneux Seel, *loc. cit.*

<sup>4</sup> Levides, *Αἱ ἐν μοναστηρίοις μοναὶ τῆς Καππαδοκίας*, 98.

<sup>5</sup> Cuinet, *Asie Mineure*, i. 841, confirmed to me by Mr. Sirinides of Talas, who has visited the *tekke*. The personalities of Hadji Bektash and S. Charalambos are so far fused in the popular mind that a well-known story of Hadji Bektash, which tells how he outdid Achmet Rufai, who rode on a lion, by riding on a wall (Degrand, *Haute Albanie*, 229) was told to Mr. Dawkins by Anatolian Greeks of S. Charalambos and Mahomet!

<sup>6</sup> See, e.g., Polites, *Δελτίον τῆς Ἰστ. Ἐταιρείας*, i. 22, and the same author's *Παραδόσεις*, No. 908; M. Hamilton, *Greek Saints*, 71.

<sup>7</sup> It has however taken firm hold, and appears to be believed in Macedonia.

not to S. Charalambos but to S. Eustathius.<sup>1</sup> The latter is connected in the *Synaxaria*<sup>2</sup> with Rome, not Anatolia, and is by no means a 'prominent saint in the Eastern Church.'<sup>3</sup> His link with Hadji Bektash is probably to be found in the incident, regularly figured in his *eikons*, of his conversion while hunting, by the apparition of a stag with a cross between its horns, which cried out with a human voice, 'Why pursuest thou me? I am Jesus Christ.' The Christian story is really pointless and was probably an importation from the East, where the idea of the Unity of Nature with God is widespread. Deer have, moreover, a special connection with dervishes, and are respected on that account.<sup>4</sup> The famous Bektashi saint Kaigousouz Sultan, like S. Eustathius, was converted out hunting by the transformation of a wounded deer into a venerable dervish. In another story Hadji Bektash himself converts an unbeliever by exhibiting on his own person the wounds inflicted by the latter on a stag. The identification of Hadji Bektash with S. Eustathius was probably made on the ground of some similar story.

2.—*Haidar-es-Sultan Tekke, near Angora.*<sup>5</sup>

Haidar, the Moslem saint buried here, is identified under Bektashi auspices with Khodja Achmet (Karadja Achmet?), a disciple of Hadji Bektash, who is said to have settled here with his wife, a Christian woman, named Mënë, from Caesarea. Local (Moslem) tradition holds that the *tekke* occupies the site of a Christian monastery.<sup>6</sup> The connection with the Bektashi is obvious from the legend: the village is 'Kyzylbash' or Shia, and as such under their religious authority.<sup>7</sup>

3.—*Tekke of Sidi Battal, near Eskishehr.*

This dervish convent, which has been in the hands of the Bektashi at least since the sixteenth century,<sup>8</sup> claims to possess the tomb of the Arab hero Sidi Battal Ghazi; beside him reposes his wife, who was, according to tradition, a Christian princess.<sup>9</sup>

<sup>1</sup> Περιγραφή τῆς Ἀρχιεπισκοπῆς Ἰκονίου, 11: 'Χατζῆ Πεκτάς, ὅπου τεκές, ἦτοι μοναστήριον πεκτάσιδων δερβισιδῶν, παρωνομασμένον ἀπὸ τῶν Ἁγίων Εὐστάθιον, Χ. Πεκτάς λεγόμενον πα' αὐτῶν, τὸν ὁποῖον θέλουσιν ἀρχηγὸν τοῦ τάγματος αὐτῶν.' The author of this rare work, of which I was fortunate enough to find a copy in the Greek Archaeological Society's Library, was archbishop of Iconium and later (1815-1818) Patriarch of Constantinople (Cyril VI.).

<sup>2</sup> Sept. 20.

<sup>3</sup> Churches are, however, dedicated to him by the Orthodox, e.g., at Konia (Ramsay, *Cities of S. Paul*, 377).

<sup>4</sup> Carnoy and Nicolaïdes, *Traditions populaires de Constantinople*, 10.

<sup>5</sup> See above p. 98, and the note at the end of this article.

<sup>6</sup> Crowfoot in *J. R. Anthr. Inst.* xxx. (1900) 305-320.

<sup>7</sup> On this point see further White in *Trans. Victoria Inst.* xl. (1908), 231. The Kyzylbash of Asia Minor are regarded by the Bektashi proper as an inferior branch of their order and called contemptuously *Soufi*. Their spiritual rulers receive authority not from the Abbot (*Akhi Dede*) of the central Bektashi *tekke* but from the *Tchelebi*, a mysterious personage who lives outside the *tekke* and claims to be an actual descendant of Hadji Bektash, and consequently the legitimate head of the order.

<sup>8</sup> Here also there must for chronological reasons have been a usurpation by the Bektashi if the traditional account of the discovery of Sidi Battal's remains by a Seljouk princess is allowed. A legend is told at the *tekke* of a visit of Hadji Bektash to the place, and, to confirm it, marks of his hands and teeth are shewn on the walls of the buildings (Mordtmann, *Φιλολ. Σύλλογος Κων'πόλεως, Παράρτημα τοῦ θ' τόμου*, xv.). Other Bektashi legends connecting the convent with Hadji Bektash or his early followers are given by Jacob (*Beiträge*, 13) from Evliya. <sup>9</sup> *B.S.A.* xix. 186.



4.—*Shamaspur Tekke, Aladja (Paphlagonia).*

Local Moslems say of this (Bektashi) *tekke*, that it was an old Greek monastery.<sup>1</sup> The saint buried there is Hussein Ghazi, the father of Sidi Battal.<sup>2</sup> The name of the *tekke*, however, seems to connect it also with *Shamas*, who figures in Turkish legend as the governor of a castle near Kirshehr, slain in single combat by Sidi Battal<sup>3</sup>: this is a popular rendering and localization of an incident in the Romance of Sidi Battal, in which *Schâmas*, brother of the governor of Amorium, is slain by the hero.<sup>4</sup> In this same romance the hero converts to Islam a monk named *Schûmas*.<sup>5</sup> It is tempting to suppose that from these materials a Christian figure, somewhat analogous to the 'monk' or 'bishop' buried in the *tekke* of the Mevlevi at Konia,<sup>6</sup> has been manufactured and intruded on the Shamaspur *tekke*.

5.—*Tekke of Nusr-ed-din, Zile (Pontus).*

This *tekke* is venerated by Christians, apparently as containing the tomb of the Forty Martyrs of Sebaste. It was formerly called Kirkklar Tekke ('Convent of the Forty') and is thought by Grégoire to have had a Christian past under that title.<sup>7</sup> The isolated position of the *tekke* in a strongly *Shia* district almost warrants the assumption that it is connected with the Bektashi.

6.—*S. Nerses, Roumkale.*

This ancient Armenian church was occupied by Mahommedans in the latter part of the seventeenth century '*afin de donner à entendre par là qu'ils revèrent les Saints & que celui auquel cette Eglise est dédiée, estoit de leur party et Musulman comme eux.*'<sup>8</sup> Roumkale is on the Upper Euphrates, not far from the country of the 'Kyzylbash' Kurds, who have a religious connection with the Bektashi.

7.—*Chapel at Adalia.*

Savary de Brèves found at Adalia a cave-chapel, still retaining traces of Christian frescoes, in which was shewn the tomb of a Christian hermit. The latter, according to the Turks, had on his death-bed confessed himself a Musulman, and on this account received from Musulmans the honour due to one of their own saints.<sup>9</sup> The Bektashi order has at the present day an establishment at Adalia.

<sup>1</sup> Hamilton, *Asia Minor*, i. 402 f.; H. J. Ross, *Letters from the East*, 343; Wilson in Murray's *Asia Minor*, 36. The *tekke* is also mentioned as a place of miraculous healing by Prof. White, *Trans. Vict. Inst.* xxxix. 159.

<sup>2</sup> For the latter see *B.S.A.* xix. 188.

<sup>3</sup> Ainsworth, *Travels*, i. 157.

<sup>4</sup> Ethé, *Fahrten des Sayyid Batthâl*, ii. 27.

<sup>5</sup> *Ibid.* 21; *Shamas* is the Arabic for *deacon*.

<sup>6</sup> *B.S.A.* xix. 195.

<sup>7</sup> *B.C.H.* 1909, 25 ff.; cf. *Studia Pontica*, iii. 243 and Jerphanion in *Mél. Fac. Orient.* (Beyrout), 1911, xxxviii.

<sup>8</sup> M. Febvre, *Théâtre de la Turquie*, (1682) 40.

<sup>9</sup> *Voyage* (Paris, 1628), 23. For a similar legendary conversion, but to Christianity, of an ambiguous saint, cf. *B.S.A.* xix. 195.

8.—'Tomb of S. Polycarp,' Smyrna.

The history of this cult is discussed at length elsewhere.<sup>1</sup> It has been, as far back as it can be traced, Moslem in form, and appears first in Moslem hands. S. Polycarp was formerly claimed as a saint of their own by the dervishes in charge of the tomb, who are shewn by the Bektashi headdress on an adjoining grave to have been at some time members of this order. A supposed mitre of the saint was shewn to pilgrims.<sup>2</sup>

9.—'Tomb of S. Theodore,' near Benderegli (Heraclea Ponti).

A *turbe* (mausoleum) on a hill above Alapli, a few miles west of Benderegli, is visited yearly by Christians as containing the tomb of S. Theodore *Stratelates*,<sup>3</sup> who, according to his legend, suffered martyrdom at Heraclea under Licinius and was buried at Euchaïta.<sup>4</sup>

The *turbe* seems to be a humble wooden erection and contains two outwardly Turkish tombs,<sup>5</sup> attributed by the Greeks to S. Theodore and his disciple Varro,<sup>6</sup> and by the Turks to a warrior saint named Ghazi Shahid Mustafa and his son. These are tended by a Turkish woman, who receives offerings from pilgrims of both religions in the shape of money and candles.<sup>7</sup>

The connection of this ambiguous cult with the Bektashi cannot be pressed, but there is a village bearing the name *Beteshler* (interpreted by von Diest as *Bektashler*, 'the Bektashis') in the vicinity.<sup>8</sup>

10.—*Mamasoun Tekke (Ziaret Kilisse) near Nevshehr.*

This sanctuary was discovered, apparently in the last century,<sup>9</sup> by a series of 'miraculous' accidents. The site was occupied by a barn<sup>10</sup> belonging to an inhabitant of the (purely Turkish) village of Mamasoun, but the hay kept in it

<sup>1</sup> Above, pp. 81 ff.

<sup>2</sup> Cf. No. 12 below (Baba Eski).

<sup>3</sup> P. Makris, *Ἡρακλῆα τοῦ Πόντου* (Athens, 1908), 115 ff.

<sup>4</sup> For the legend of S. Theodore see Delehaye, *Saints Militaires*, ch. ii.

<sup>5</sup> Makris describes them as 'δύο ξύλινα κιβώτια ἄνω ἐνε φέρετρα,' adding 'πρὸς τὸ μέρος τῆς κεφαλῆς φέρουσι κιδάρεις [turbans] καὶ μέγα κομβολόγιον [rosary].'

<sup>6</sup> 'Varro' (Οὐάρρων) does not figure in the orthodox legend of S. Theodore: Makris speaks of an ancient inscription formerly kept at the site; it possibly contained the name.

<sup>7</sup> A similar mixed cult of S. Theodore and 'un santon dit "Gaghni"' in Pontus was reported by Père Girard to Cumont, but without details (*Stud. Pont.* ii. 143 note 3).

<sup>8</sup> Von Diest, *Pergamon zum Pontus*, 81. *Betesh* or *Petesh* seems to be the original form of *Bektash*. In George of Hungary's *De Turcorum Moribus* (cap. xv.), written in the middle of the fifteenth century, the saint is called *Hartschi Petesch* (translated *adiutorius peregrinationis*). The form *Bektash* seems to depend on a false etymology from *geubek* ('navel') and *tash* ('stone') as Leake betrays:—'The Bektashli are so called from a Cappadocian sheikh who wore a stone upon his navel' (*N. Greece*, iv. 284).

<sup>9</sup> It is not mentioned in the Archbishop Cyril's *Περιγραφή τῆς ἀρχιεπισκοπῆς Ἰκονίου* (1815) or indicated in his map, 1812, which generally marks even purely Moslem *tekkes* of importance.

<sup>10</sup> So Nicolaïdes; but from Rott's account it would appear that the *tekke* is one of a series of rock-cut churches, many of which are still used as barns.

caught fire repeatedly. As a stable the building proved equally unlucky, and the animals occupying it died one by one. These warnings finally induced the proprietor to excavate, very possibly under directions from a dervish and with a view to finding the 'talisman' which bewitched the building.<sup>1</sup> A rock-cut Christian church and human bones were then discovered, and the latter, probably on account of the name of the village, attributed to S. Mamas.<sup>2</sup> The church has been adapted for the ambiguous modern cult. At the east end is a Holy Table, at which itinerant Christian priests are allowed to officiate, and a picture of S. Mamas, while in the south wall is a niche (*mihrab*) giving the orientation of Mecca to Turkish pilgrims. There is no partition between Christian and Moslem worshippers, but the latter, while at their prayers, are allowed to turn the picture from them. The sanctuary is administered by dervishes.<sup>3</sup>

An analysis of these ten cases of ambiguous sanctuaries in Asia Minor gives the following results:—

1. Connection with the Bektashi is established in five cases (1, 2, 3, 4, 8). The remainder of the sanctuaries are situated within the area of Bektashi activities and are not known to be in other hands.

2. Christian saints are claimed as Moslem by the 'conversion' or analogous *motifs* in four, possibly five, cases (5 (?), 6, 7, 8, 10).

3. Apparently Moslem saints are claimed as Christian by 'identification' in two cases (1, 9). Moslem sanctuaries have a Christian side developed by 'intrusion' in two, possibly three, cases (2, 3 (?), 4).

#### BEKTASHISM AND CHRISTIANITY IN EUROPE.

The 'lay-figure' of Bektashi propaganda amongst the Christians of Roumeli is Sari Saltik,<sup>4</sup> whose elaborate legend has been discussed in the last volume of the *Annual*.<sup>5</sup> Sari Saltik, originally, as I believe, a tribal

<sup>1</sup> For the procedure see the tale of the 'Priest and the Turkish Witch' in Polites' *Παραδόσεις*, No. 839.

<sup>2</sup> *Mamasoun* would be near enough to the Turkish genitive from *Mamas*. The saint, however, was born at Gangra in Paphlagonia and suffered at Caesarea. The name of the village is probably a corruption of the ancient *Momoassos* (Ramsay, *Hist. Geog.* 285).

<sup>3</sup> For the tradition of the haunted building and the origin of the cult see Carnoy and Nicolaïdes, *Traditions de l'Asie Mineure*, 193; for the church-mosque, Levides, *Αί ἐν μονολίθις μοναί*, 130 f.; Pharasopoulos, *Τὰ Σύλαρα*, 74 f. I am indebted to Mr. Sirinides of Talas for first-hand information not contained in these authors. The church-mosque is mentioned as a place of pilgrimage of Greeks, Armenians, and Turks by H. Rott, *Kleinas. Denkmäler*, 263.

<sup>4</sup> Khizr has also an importance, at present ill-defined, for Albanian Bektashism (Durham, *Burden of the Balkans*, 208).

<sup>5</sup> *B.S.A.* xix. 203 ff.

saint,<sup>1</sup> is identified in a general way with S. Nicolas, and seems to have occupied a certain number of churches dedicated to that saint in eastern Turkey in Europe.

These can all be brought into relation with the earliest cycle of the Sari Saltik myth, which concerns itself with his apocryphal adventures in Europe, and ends with his death and the miraculous transformation of his body into *seven* bodies, four of which were buried in Turkish territory (Thrace, Bulgaria, Roumania, Crimea?) and three in Christian Europe (Bohemia, Dantzic, Sweden).<sup>2</sup> In a variant version, from a manuscript discovered by Degrand at Tirana, *forty* bodies of Sari Saltik are found after his death; one of these is singled out by a miracle as the genuine corpse and buried in a circle composed of the other thirty-nine.<sup>3</sup> This variant suggests a pretext was needed for the usurpation of some cult of 'the Forty.'<sup>4</sup>

In the western section, which appears to have been touched by Bektashi propaganda a good deal later than the eastern, and now contains in Albania the chief stronghold of the sect, Sari Saltik is identified with the Christian saints Naoum and Spyridon. The corresponding cycle of

<sup>1</sup> This idea, put forward tentatively in *B.S.A.* xix., gains weight from the following considerations: (1) Colour-adjectives ('black,' 'white,' 'red,' 'blue') like *Sari* ('yellow') are often prefixed to tribal names, possibly alluding to the distinctive colouring or marking of the herds of sections of a divided tribe. (2) A town in the Crimea named *Baba Saltouk* after 'a diviner' (*i.e.*, a tribal holy man?) is mentioned by Ibn Batuta (tr. Sanguinetti, ii. 416, 445), and *Baba Dagh*, the starting-point of the Sari Saltik of Bektashi tradition, was colonised by Tartars, probably from the Crimea. (3) *Saltaklu* appears as a village-name near Eski Baba in Thrace, and *Saltik* in Phrygia near *Sandykli*. (4) It is obvious that *Saltik*, like *Betesh* (above, p. 105, note 8), means nothing to the ordinary Turk, by the frequent attempts to produce an etymology for it. *Sari Saltik* is variously rendered 'The Blond Apostle' (Ippen, *Shutari*, 72); 'the Yellow Corpse' (λειψανον), which was the explanation offered me by the Abbot of S. Naoum (see below No. 19); 'Yellow Pate' (Bodleian *Cod. Rawlinson*, C. 799. f. 50 *verso*); 'Yellow Jacket' was the translation offered me by a bey of Ochrida; a still more complicated derivation, from *salmak* ('dismiss'), is given from a native source by Degrand (*Haute Albanie*, 240).

<sup>2</sup> This version is set down by the seventeenth-century traveller Evliya Effendi on the authority of the dervishes of Kilgra (*Travels*, tr. von Hammer, ii. 70-72).

<sup>3</sup> Degrand, *Haute Albanie*, 240: the MS. is said by Jacobs to be the *Vilayetname* of Hadjim Sultan (*Beiträge*, 2 n. 4)\*

<sup>4</sup> For cults of 'the Forty' see *B.S.A.* xix. 221 ff.; the Bektashi may have been aiming at the 'Forty' cult of Kirk Kilisse, discussed on p. 224, or even SS. Quaranta in Albania, where there is said to be a ruined monastery containing forty underground chambers, one for each saint. Ali Pasha of Yannina, whose connection with the Bektashi and the Sari Saltik legend is discussed below, restored the adjacent fortress (Παργανσός, ii. 462, cf. Leake, *N. Greece*, i. 11.). But a Bektashi *tekke* has never existed there. On the other hand the sect lays claim to a 'Forty' cult in Larissa.

the Sari Saltik myth now current in Albania, makes that country the exclusive scene of the saint's activity. He appears at Croia, where he slays a dragon, and in the sequel, to escape persecution, crosses miraculously to Corfou, where he dies.<sup>1</sup> To the date and bearing of this part of the legend we shall return.

The following ambiguous sanctuaries may be cited from the European area :—

11.—*Tekke of Sari Saltik, Kilgra (Bulgaria).*

This Bektashi sanctuary (now abandoned), on the promontory of Kilgra (Kaliakra) in Bulgaria, was held by its former dervish occupants to have been the scene of Sari Saltik's fight with the dragon, and one of the seven places where he was buried.<sup>2</sup> Local Christians now hold that it contains the tomb of S. Nicolas, with whom it may have been associated in Byzantine times; for the Turks the saint worshipped there is now known as Hadji Baba.<sup>3</sup>

12.—*Tekke at Baba Eski (Thrace).*

The Bektashi in charge of this sanctuary in the seventeenth century identified the saint buried in it with their own Sari Saltik and the Christian S. Nicolas.<sup>4</sup> The *tekke* is said to be a former Christian church and is to this day frequented by Christians.<sup>5</sup> A mitre and other relics, alleged to have belonged to S. Nicolas, were formerly shewn here, but were not accepted as genuine by the Christians.<sup>6</sup>

13.—*Tekke of Binbiroglou Achmet Baba, Bounar Hissar (Thrace).*

Macintosh in 1836 found just east of Bounar Hissar 'a cemetery distinguished by a tower-shaped building with a dome roof said to be a remnant of an ancient Greek church dedicated to S. Nicolas, but now the burying-place of a wealthy Turkish proprietor.'<sup>7</sup> Boué, who describes the already deserted *tekke* of this day (1837), speaks of the saint as a 'general Achmet' who was regarded as the conqueror

<sup>1</sup> Degrand, *Haute Albanie*, 207.

<sup>2</sup> *B.S.A.* xix. 205.

<sup>3</sup> *Arch. Epig. Mitth.* x. (1886) 188 f.: 'Am äussersten Ende gibt es neben dem Leuchthurm vier kleinere, künstlich ausgeglättete und mit gemisselten Sitzen versehene Höhlenkäume, die wie Wohnzimmer untereinander verbunden sind. Eine mit einen niederen Umfassung zugemauerte Ecke darin gilt den Christen als Grab des heil. Nikola, den Türken als das des "Hadji Baba."'

<sup>4</sup> *B.S.A.* xix. 205.

<sup>5</sup> M. Christodoulos, *Περιγραφή Σαράντα Ἐκκλησιῶν*, 47: Τὸ ἀρχαῖον ὄνομα ἀντικατέστη διὰ τοῦ σήμερον ἐκ τοῦ τάφου πολιούχου Δερβιση (Βαβῆ) χαίροντος ὑπόληψιν παρὰ Τούρκους τε καὶ Χριστιανοῖς κειμένον ἐν τῷ παρὰ τῇ κώμῃ εἰς τεκὲν μεταβληθέντι ἀρχαίῳ Ναῷ τοῦ Ἁγίου Νικολάου ἐν ᾧ καὶ κατῴκει. I was told in 1909 that Christians still frequented the *tekke*.

<sup>6</sup> S. Gerlach, *Tagebuch*, 571: 'Diese Waffen, sprechen die Türcken, habe St. Nicolaus gefuhret: Die Griechen aber sprechen, die Türcken habens nur hinein gehanget.'

<sup>7</sup> *Military Tour*, i. 73.

of the country.<sup>1</sup> Bektashi saints in Roumeli are often represented as early *ghazis*. The full name of the saint, and that of the order to which the *tekke* belonged (Bektashi), are given by Jochmus, who visited the place in 1847.<sup>2</sup> The 'ambiguous' character of the sanctuary is betrayed, in the light of Albanian and other parallels,<sup>3</sup> by Macintosh's words.

14.—*Tekke of Akyazyly Baba, near Baltchik (Roumania).*

Though it is nowhere distinctly stated that this *tekke* was in the hands of the Bektashi, the phenomena are so similar to those of known Bektashi sanctuaries that this seems almost certain.<sup>4</sup> The saint, who appears to have been purely Moslem in origin,<sup>5</sup> develops a Christian side as S. Athanasius, who, under present conditions, seems in a fair way to usurp all the honours of the place.<sup>6</sup>

15.—*S. Eusebia, Selymbria (Thrace).*

What seems, in the light of modern developments in Albania,<sup>7</sup> to be a corresponding adoption of a Christian saint by the Bektashi is noted by Cantemir in Thrace, a former stronghold of the order. 'At Selymbria are preserved entire,' he says, 'the remains of S. Euphemia: the Turks call her *Cadid*, and visit her out of curiosity.'<sup>8</sup> The allusion is to the body of S. (ὁσία) Xene (in religion Eusebia) of Mylasa, which is still preserved in the church of the Virgin at Selymbria.<sup>9</sup> Here as in Albania, if our supposition is correct, the Bektashi have selected an ancient church containing the tangible relics of a popular saint, whom they have re-named for the purposes of their propaganda.

<sup>1</sup> *Itinéraires dans la Turquie d'Europe*, i. 132 :—' On n'y voit plus qu'un pays couvert de broussailles, au milieu duquel il y a une petite mosquée et vis-à-vis un bâtiment carré entouré d'une muraille. La mosquée n'est que le monument qui recèle les restes du général Achmed, le conquérant de ce pays, et ceux de quelques uns de ses parents. Une natte entoure le tombeau afin qu'on puisse y prier. Un cimetière est autour de cet édifice, qui est un lieu de pèlerinage et le bâtiment carré sert à héberger alors les devots.' The *tekke* was probably one of those put down in 1826, and is now a *chiflik* or farm.

<sup>2</sup> *J.R.G.S.* xxiv. (1854) 44.

<sup>3</sup> Especially Nos. 17, 18, below.

<sup>4</sup> This I have since ascertained to be the case.

<sup>5</sup> He was possibly tribal: a village named Akyazyly formerly existed in Bulgaria (*Arch. Epig. Mitth.* x. (1886), 161), and there is a village Akyazi in Bithynia.

<sup>6</sup> Kanitz, *Bulgarie*, 473 ff.; Jireshek, *Bulgarien*, 533; cf. *Arch. Epig. Mitth.* x. (1886) 182; J. Nikolaou, 'Ὁδησός (Varna, 1894), 248-250. I was told by a local resident that during the last war the crescent on the *turbe* had been displaced in favour of a cross by the Bulgarian priest of the village. I hope in another place to discuss in detail the development of this cult.

<sup>7</sup> Below, Nos. 19, 20.

<sup>8</sup> *Empire Ottoman*, tr. Joncquières, i. 121. Turks or Greeks will of course frequent any miraculous shrine for cure irrespective of religion; the renaming stamps this case as peculiar. Von Hammer (*Hist. Emp. Ott.* iii. 14) translates *Cadid* by *momie*, but I can find no authority for this.

<sup>9</sup> S. Xene figures in the *Synaxaria* of Jan. 24. Her relics at Selymbria are mentioned already in 1614 by Pietro della Valle (*Viaggio*, i. 47) and in modern times are one of the attractions of a frequented Orthodox pilgrimage, cf. *Θρακική Ἐπετηρίς*, i. 68; *Ξενοφάνης*, ii. 256, 322. A distaff and other belongings of the saint are also shewn; such relics are comparatively rare in Orthodoxy, exceedingly common in popular Islam.

In the Western section of Turkey in Europe, which includes Albania, the great stronghold of Bektashism to-day, many ambiguous sanctuaries besides those here set down probably await discovery. The Turkish conquest of Albania was late and partial: there was little or no colonization of the country by genuine Turks, such as has taken place in some other parts of Roumeli. The Moslems of Albania thus represent to a very large extent Christian populations converted, some only nominally, at various dates.<sup>1</sup> They are generally considered lax Mahommedans, and share much of the superstition of their Christian compatriots. The Tosks are largely *Shia*.<sup>2</sup> For Albanian Christians the material inducements to become at least nominally Musulmans have always been great. A more promising field for Bektashi propaganda could hardly be found.

The following ambiguous sanctuaries may be cited from the western area, all demonstrably depending on the propaganda of the Bektashi. The historical background of their development will be discussed later.

16.—*Tekke of Turbe Ali Sultan, Rent, near Velestino*<sup>3</sup> (*Thessaly*).

This, the last remaining Bektashi convent in 'old' Greece, is visited by Christians as a sanctuary of S. George, and a 'tradition' is current that it occupies the site of a Christian monastery dedicated to that saint. There is no trace of previous Christian occupation.<sup>4</sup>

17.—*Tekke of Sersem Ali, Kalkandelen*.

The Bektashi saint supposed to be buried here is identified by local Christians with S. Elias, apparently on no other grounds than the similarity between the names *Ali* and *Elias*.<sup>5</sup> The history of the foundation will be discussed below.

18.—*Tekke of Karadja Achmet, near Uskub*.

This (Bektashi) *tekke*, near the present station of Alexandrowo (between Uskub and Kumanovo), has been described at some length by Evans, who notes that it was in Turkish times frequented by Christians on S. George's day.<sup>6</sup> The identi-

<sup>1</sup> For the conversion of Albania see T. Arnold, *The Preaching of Islam*, 152 ff.

<sup>2</sup> Ibrahim Manzour, *Mémoires sur l'Albanie*, xvii. A false prophet, claiming to be an incarnation of Ali, appeared in Albania in 1607 (*Ambassade de J. de Gontaut-Biron*, Paris, 1889, 138).

<sup>3</sup> South of the station Aivali, between Velestino and Pharsala.

<sup>4</sup> F. W. H.

<sup>5</sup> F. W. H.

<sup>6</sup> *J.H.S.* xxi. 202; cf. *Archaeologia*, xlix. 110.

fication of Karadja Achmet<sup>1</sup> with S. George has taken such hold on the Christian population that since the Balkan war and the Servian conquest of the district the sanctuary has been formally claimed for Christianity by the erection of a cross, though the dervish in charge has not been evicted.<sup>2</sup>

19.—*Monastery of S. Naoum on lake Ochrida.*

This monastery, containing the tomb of the saint, one of the seven apostles of the Slavs, is known to local Moslems generally as Sari Saltik, with whom the Christian saint is identified<sup>3</sup>; the Bektashi of the adjoining (Koritza) district make pilgrimage to the tomb. Already in the twenties of the last century Walsh remarks that 'the Turks claim S. Naoum as a holy man of their religion,'<sup>4</sup> and von Hahn in the sixties found a prayer-carpet kept at the tomb for the benefit of Moslem pilgrims<sup>5</sup>: this carpet, not being a necessary, or even a usual, feature of a Moslem cult, was probably considered, or on its way to be considered, a personal relic of the saint. While I was at S. Naoum (1914) the Greek abbot, to whom I am indebted for information on the relations of the Bektashi with the monastery, told me that he had received a visit from the abbot of one of the Bektashi *tekkes* at Koritza, who told him that Sari Saltik, on a visit to the monastery, had, with the Christian abbot, miraculously crossed the lake to Ochrida on a straw-mat (*ψάθα*). Such miraculous journeys, generally made on prayer-rugs, are a regular *motif* of dervish stories.<sup>6</sup> The introduction of Ochrida may indicate the beginning of an adoption by the Bektashi of the church and tomb of S. Clement in the latter town.

20.—*S. Spyridon, Corfou.*

S. Spyridon, as we have said, is one of the Christian saints identified by the Bektashi with their own apostle Sari Saltik<sup>7</sup>; this explains the introduction of Corfou, where S. Spyridon's body is preserved in the cathedral, into the Croia cycle of Sari Saltik's adventures.<sup>8</sup> Albanian Bektashi are said to make pilgrimage to the saint in Corfou.<sup>9</sup>

<sup>1</sup> Karadja Achmet is a regular Bektashi 'intrusion' figure of the same type as Sari Saltik: see below p. 121.      <sup>2</sup> From a local Mahomedan informant (1914).

<sup>3</sup> According to one Bektashi tradition, Sari Saltik settled at the monastery, converted, and eventually succeeded, the Christian abbot. This is a mild edition of the earlier episode at Dantzig (*B.S.A.* xix. 204).

<sup>4</sup> Constantinople, ii. 376; cf. E. Spencer, *Travels in Turkey*, ii. 76.

<sup>5</sup> *Drin und Wardar*, 108 f.

<sup>6</sup> The incident occurs in the 'first edition' of the Sari Saltik legend, where the saint and his companions cross in this way to Europe, and in a version of the Croia-Corfou cycle told me by the Sheikh at the *tekke* of Turbe Ali; in this latter story the dervish's habit (*háro*=*khirka*) was the vehicle. For the theme in Christian and other hagiologies see Saintyves, *Saints Successeurs des Dieux*, 254.

<sup>7</sup> Miss Durham heard this at Croia (*Burden of the Balkans*, 304), I from a southern Albanian Bektashi at Uskub, from the Sheikh of the *tekke* at Reni, and from the abbot of S. Naoum.      <sup>8</sup> *B.S.A.* xix. 207, where it is wrongly explained.

<sup>9</sup> I am told by an English Corfiote of the older generation, Mr. Weale, that in his childhood many Albanian Moslems visited the cathedral at S. Spyridon's two festivals, and paid their respects to the saint's remains: they often brought with them offerings of candles and even of livestock. [This has been abundantly confirmed by enquiries at Corfou.]



An analysis of these ten ambiguous sanctuaries in Europe gives the following results :—

(i) Connection with the Bektashi is established in eight cases (11, 12, 13, 16, 17, 18, 19, 20).

(ii) Bektashi sanctuaries are made accessible to Christians by 'identification' in five cases (13, 14, 16, 17, 18).

(iii) Christian sanctuaries are made accessible to Bektashi by 'identification' in four, possibly five, cases (11, 12, 15 (?), 19, 20)

It will be noted that the mental attitude of Bektashi and Christians with regard to these ambiguous sanctuaries is somewhat different. The educated Bektashi, to whom the ideas of pantheism and metempsychosis are familiar, find it easy and natural to identify the Christian saints with their own; for simpler souls, if indeed the efficacy of the miracles does not suffice them, fables like the 'disguise' of Sari Saltik in the robes of 'Svity Nikola'<sup>1</sup> may be used to bridge the gap. Christians, having before them numerous examples of churches usurped by the Moslem conqueror, accept rather the assumption that the Bektashi sanctuary occupies a site already consecrated by Christian tradition, though their act of worship is made in the actual tomb-chamber of the Moslem saint, and conforms to the custom of the Moslem sanctuary. This leads in some cases to the belief that the buried Saint himself was a Christian, and political changes may lead to the definite and official transference of the *tekke* to Christianity.<sup>2</sup> In the promulgation and acceptance of these fictitious identifications the material interests of the parties concerned have evidently played an important part. The occupiers of the ambiguous sanctuary, be they Christian or Bektashi, find their *clientèle*, and consequently their revenues, increased, while the frequenters receive the less tangible but not less appreciated benefits of miraculous healing and intercession.

The concessions of Bektashism to Christianity and of Christianity to Bektashism seem at first sight exactly balanced. Christian churches adopt fictitious Bektashi traditions and receive Bektashi pilgrims: conversely, Bektashi *tekkes* adopt fictitious Christian legends and receive Christian pilgrims. But the apparent equality is only superficial. The ultimate aim of the Bektashi was not to amalgamate Christianity with

<sup>1</sup> *B.S.A.* xix. 204.

<sup>2</sup> Cf. Nos. 14, 18 above.

Bektashism on equal terms but to absorb Christianity in Bektashism. It may well be that the partial adoption by the Bektashi of such churches as S. Naoum and S. Spyridon really represent intermediate stages in the process of transition from exclusive Christian ownership to complete Bektashi occupation. In Albania we can understand that the process was arrested by the revival of the Orthodox Church in the eighteenth century. In Thrace we seem to see in Eski Baba, where a Christian church has become completely Bektashi, an example of successful transference at a more favourable date. In Anatolia it is at least possible that the same methods were used earlier still, so early and with such complete success that no trace of the process remains : but we have always to bear in mind the possibility that supposed Christian ' traditions ' are to be accounted for by false legends, circulated or countenanced from interested motives by the dervishes in charge, or on patriotic grounds by the local Christians.

POLITICAL BACKGROUND.

The propagation of such a religion as Bektashism is considerably aided if it can rely on the support or connivance of the civil power, especially as it is regarded by orthodox Moslems as heretical. In the case of the western (Albanian) group of ambiguous sanctuaries under Bektashi influence clear traces can be detected of a political combination such as we have suggested in explanation of the analogous religious phenomena at mediæval Konia. The spread of Bektashism in Albania is generally thought to be due to the support given to the propagandists by Ali Pasha of Yannina (d. 1822)<sup>1</sup> : this idea will be found to be well grounded, and there are hints that Ali's relations with the Bektashi were paralleled by those of other Albanian and Roumeliote potentates. It is still strongly held in Tepelen, the birthplace of Ali, that his connection with dervishes was an important factor of his success. One tradition says his father was a dervish.<sup>2</sup> Ali himself believed devoutly in dervishes, and not without reason. It is said that while still a poor and insignificant boy he was pointed out by a wandering holy man, to whom he and his mother had, despite their poverty, offered shelter and hospitality, as one that had a great future. This same holy man gave him

<sup>1</sup> Brailsford, *Macedonia*, 233, 244. This I have found generally admitted by South Albanian Bektashi, some of whom also connect Omer Vrioni of Berat and Mahmoud Bey of Aulona, both contemporaries of Ali, with the movement.

<sup>2</sup> Durham, *Burden of the Balkans*, 239.

a 'lucky' ring, which he wore even at the end of his life.<sup>1</sup> His superstitious belief in prophecy was enhanced by his contact with the Greek monk and evangelist Cosmas (afterwards canonized), who foretold to him, already in 1778, that he should prevail over the pasha of Berat, become vizir of Epirus, fight with the Sultan, and go to Constantinople 'with a red beard'<sup>2</sup>—all of which eventually came to pass.

It was apparently in his later life that Ali 'got religion'; naturally it was not the strict observance of *Sunni* puritans that attracted him, but rather the licence and superstition of the less reputable members of the dervish orders, and their potential political importance. 'In his younger years,' writes Hobhouse in 1809, 'Ali was not a very strict Mahometan; but he has lately become religious and entertains several dervishes at his court.'<sup>3</sup> I was told definitely by a Bektashi sheikh that Ali was admitted to their order by the celebrated Sheikh Mimi of Bokhara, who was certainly alive in 1807.<sup>4</sup> This is probably the change to which Hobhouse refers.

Towards the end of his life the Pasha was much addicted to the society of dervishes, and Yannina became notorious as the haunt of the most disreputable of them.<sup>5</sup> Ibrahim Manzour enumerates no fewer than seven prominent sheikhs of his own time who received special favours from Ali,<sup>6</sup> being provided with endowed *tekkes* or other establishment. One of them Ali used regularly as his diplomatic agent; another toured in Albania, collecting contributions for the order, and, doubtless, information for his master also. The sheikh of a *tekke* at Seutari (Constantinople) visited the court of Yannina regularly once a year.<sup>7</sup> The local (Epirote) Bektashi

<sup>1</sup> Ibrahim Manzour, *Mém. sur la Grèce et l'Albanie*, 271 (the author was a French renegade who spent some years (1816-19) at Ali's court): a similar story was told to Miss Durham at Tepelen.

<sup>2</sup> Zotos, *Δεξικὸν τῶν Ἀγίων*, s.v. Κοσμάς, 621; cf. Sathas, *Νεοελλ. Φιλολογία*, 491. It should be noted that a very similar prophecy is attributed by the Bektashi to three of their own saints, Sheikh Mimi, Sheikh Ali, and Nasibi.

<sup>3</sup> *Travels*, i. 124.

<sup>4</sup> See below. Aravantinos (*Ἱστορία Ἀλῆ Πασσᾶ*, 417) says that Ali boasted that he was a Bektashi. The headstone of the tomb of Ali at Yannina was formerly marked by the twelve-sided headdress (*taĵ*) of the order, as is shewn in a drawing in Walsh's *Constantinople and the Seven Churches*. The headstone has been removed within living memory.

<sup>5</sup> Leake *N. Greece*, iv. 285:—'There is no place in Greece where in consequence of this encouragement these wandering or mendicant Musulman monks are so numerous as at Yannina.' Ibrahim Manzour says the same of his own time.

<sup>6</sup> *Mémoires*, 211.

<sup>7</sup> *Ibid.* 291.

with whom I have conversed on the subject did not recognise the names of the sheikhs enumerated by Ibrahim Manzour as belonging to their sect: the one possible exception was Sheikh Hassan, who is probably identical with the Bektashi saint Hassan Baba Sheret, buried outside Yannina.<sup>1</sup> My informants were agreed that their order had never possessed a *tekke* in Yannina or south of it, on account of the fanatical orthodoxy of local Moslems. Ali himself did not openly admit his connection with the heretical sect.<sup>2</sup> It is, of course, possible that some of the apparently orthodox dervishes in his pay were either secret adherents of the Bektashi or (to use no harsher word) latitudinarian in their beliefs.<sup>3</sup>

Ali's connection with the Bektashi was mainly, perhaps, a matter of policy,<sup>4</sup> but his personal religion, such as it was, shews the mixture of atheism, tempered by superstition, and tolerance towards other sects, especially Christians, which is characteristic of the lower forms of Bektashism. 'At the time that Christianity was out of favour in France,' says Leake, 'he was in the habit of ridiculing religion and the immortality of the soul with his French prisoners, and he lately remarked to me, speaking of Mahomet, *καὶ ἐγὼ εἶμαι προφήτης εἰς τὰ Ἰωάννινα*—and I too am a prophet at Joannina.'<sup>5</sup> But with all this he had a deep-rooted belief in charms, magic, and prophecy. As regards his tolerant attitude towards Christians he may have been influenced by the prophecy of Cosmas, whose memory he perpetuated by the erection of a monastery to enshrine his remains.<sup>6</sup> His Greek wife was allowed an Orthodox chapel in his palace at Yannina,<sup>7</sup> and many Christian churches were built by his permission,<sup>8</sup> a concession exceptional, if not illegal, in his time: on the other hand he is said never to have built a mosque.<sup>9</sup> In his courts

<sup>1</sup> Of the others I was only able to trace Sheikh Broussalou, whose tomb is still to be seen in Preveza; he is regarded as an orthodox saint.

<sup>2</sup> Ibrahim Manzour, *Mémoires*, xix.: one of Ali's sons, Mouktar Pasha, openly avowed himself *Shia*; Selim, another son by a slave wife, is said to have become a dervish *sheikh* (North, *Essay on Ancient and Modern Greeks*, 191).

<sup>3</sup> The distinctions between the Bektashi and other orders are not rigid. I have heard of two recent cases of the conversion of sheikhs of other orders to Bektashism.

<sup>4</sup> Leake, *N. Greece*, iv. 285: 'Although no practical encourager of liberty and equality he finds the religious doctrines of the Bektashli exactly suited to him' . . . 'Aly takes from every body and gives only to the dervises, whom he undoubtedly finds politically useful,' cf. *ibid.* i. 407.

<sup>5</sup> *Ibid.*

<sup>6</sup> Zotos, *loc. cit.*

<sup>7</sup> Beauchamp, *Vie d'Ali Pacha*, 181.

<sup>8</sup> Juchereau, *Empire Ottoman*, iii. 65.

<sup>9</sup> Miller, *Ottoman Empire*, 64; but the statement needs modification; cf. Holland, *Travels*, i. 412; Leake, *N. Greece*, i. 152.

Christians were rather favoured than otherwise.<sup>1</sup> Here, as in his alliance with the Bektashi, which was of the nature of a compact in the interest of both parties, we must not lose sight of the political motive: to conciliate the Christians was to bid for the support of an important minority which might otherwise give trouble.

So much for Ali's connection with the Bektashi and the activities of the latter in Yannina itself. Leake, who already recognised the Pasha's predilection for the Bektashi, noted in Thessaly, then one of his dependencies, *tekkes* at Trikkala and at Aidinli (near Agia) built at his expense.<sup>2</sup> Croia, which was in the *pashalik* of Scutari, and is now the great stronghold of Bektashism in Northern Albania, was for some years the residence of Sheikh Mimi, who had admitted Ali to the order. Mimi's missionary work at Croia was conspicuously successful. He founded a *tekke* there in 1807, apparently beside an existing (or reputed) saint's grave but eventually fell a victim to his intrigues against the civil governor.<sup>3</sup> It is possibly in connection with this incident that the Pasha of Scutari banished from his capital all Bektashi dervishes as emissaries of Ali.<sup>4</sup>

We have thus direct evidence of Ali's connection and collaboration with the Bektashi in Thessaly which formed part of his satrapy, and in the province of Scutari outside it. It thus seems probable that the same combination was responsible for much of the recent conversion of the Southern (Tosk) Albanians in the districts north of Yannina (Argyrokastró, Premeti, Konitza, Leskovik, Kolonia, Koritza), which are at the present day strongly Bektashi.<sup>5</sup> Patsch, speaking of the district of Berat, remarks significantly that all Tosk and Liap Albanians first converted under Ali Pasha, though they outwardly conform, are in fact but indifferent Mussulmans, caring little for mosques or prayers.<sup>6</sup>

The claims of the Bektashi to the Christian saint Naoum, buried near Koritza, may possibly be traced to the period and influences of Ali's supremacy. The monastery of S. Naoum was rebuilt in 1806,<sup>7</sup> and Leake, who visited it in 1809, remarks the special favour shewn to it by Ali.<sup>8</sup> Von Hahn was told in the sixties that the fame of the monastery was

<sup>1</sup> Beauchamp, *loc. cit.*

<sup>2</sup> *N. Greece*, iv. 284, 413; cf. Pouqueville, *Voyage de la Grèce*, iii. 384.

<sup>3</sup> Degrand, *Haute Albanie*, 209, cf. 240.

<sup>4</sup> Ippen, *Skutari*, 36.

<sup>5</sup> This is admitted both by Christians and Bektashi.

<sup>6</sup> *Das Sanschák Berat*, 53.

<sup>7</sup> *Ath. Mitth.*, 1902, 440.

<sup>8</sup> *N. Greece*, iv. 149.

relatively recent, and that it was under the official protection of a local Moslem (Bektashi?) family<sup>1</sup>: the reverence shewn by the Turks for S. Naoum is mentioned about the the time of Ali's death by Walsh.<sup>2</sup>

As to the Sari Saltik-S. Spyridon equation, it occurs first in the Croia cycle of the Sari Saltik legend, the whole of which is foreign to the earlier version given by Evliya: the adventures of the saint at Croia may well have been adapted from the original legend for local consumption by Ali's agent there, the missionary Sheikh Mimi. One of Ali's great political ambitions was to add the Ionian islands to his dominions, and especially S. Mavra and Corfou, as being opposite respectively to Preveza and Sayada and SS. Quaranta, the ports of his capital Yannina.<sup>3</sup> S. Mavra he nearly succeeded in taking<sup>4</sup>: Corfou had been prophetically promised him by a dervish named Sheikh Ali (d. 1817) in whom he implicitly believed.<sup>5</sup> The alleged tomb of Sari Saltik would form in Corfou just such a religious bait to his followers as had been provided by the earlier version of the legend at certain points in Christian Europe.<sup>6</sup>

The *tekke* at Kalkandelen<sup>7</sup> offers a similar example of retrospective legend. It was built, according to information collected on the spot, by a certain Riza Pasha at the instance of a Bektashi dervish named Mouharrebe Baba, to whom was revealed at Constantinople (presumably by a vision) the site of the grave of a great Bektashi saint, Sersem Ali, at Kalkandelen. The *tekke* at Kalkandelen now contains amongst others the graves of Sersem Ali and of the two founders, Mouharrebe Baba and Riza Pasha.

Sersem Ali is supposed to have died in the middle of the sixteenth century,<sup>8</sup> and has, beyond this reputed grave, no connection with Albania. Riza Pasha's tomb is dated 1238 A.H. (= 1822-3 A.D.). It thus seems fairly clear that the tomb of Sersem Ali is not authentic, and that the dervish's 'vision' was part of the Bektashi propaganda in Albania. To judge by the date of Riza Pasha's death (the same as that of Ali) the *tekke* may well belong to the series dating from the period of Ali's power.

<sup>1</sup> *Drin und Wardar*, 108.

<sup>2</sup> *Constantinople*, ii. 376 (quoted above).

<sup>3</sup> Beauchamp, *Vie d'Ali Pacha*, 163, 194; Holland, *Travels*, i. 405, 450, etc.

<sup>4</sup> Leake, *N. Greece*, iii. 13. In Leake's time the fort, still called *Tekke*, on the mainland opposite S. Mavra was actually a dervish convent.

<sup>5</sup> Ibrahim Manzour, *op. cit.* 234. Sheikh Ali is claimed by the Bektashi.

<sup>6</sup> Cf. *B.S.A.* xix. 206.

<sup>7</sup> Above, No. 17.

<sup>8</sup> Jacob, *Bektaschiye*, 27.

Both at Croia and at Kalkandelen fabricated evidence of earlier Bektashi occupation seems to have been made the pretext or justification for the founding of Bektashi *tekkes*, in the former case by a known emissary of Ali Pasha, in the latter probably independently of his influence. Kalkandelen seems at this period to have been subject with Uskub to hereditary pashas of old standing,<sup>1</sup> of whom Riza was probably one.

Other local pashas in Roumeli were manifestly in touch with the Bektashi movement at about the same date. Hassan Pehlivan Baba, pasha of Rustchuk, founded the *tekke* of Demir Baba, a saint supposed to have lived 'four hundred years ago.'<sup>2</sup> This *tekke* seems certainly to have been Bektashi, as it suffered under Mahmoud II,<sup>3</sup> the notorious persecutor of the sect; the pasha himself appears to have been loyal to the Sultan, though his title of 'Baba' seems to indicate that he held a high position in the Bektashi hierarchy. Another contemporary governor who may reasonably be suspected of Bektashi leanings is the notorious Paswanoglou, whose successful rebellion (1799) against Selim III. brought him the pashalik of Widin.<sup>4</sup> He seems to have been a strong partizan of the Janissaries (who were backed by the Bektashi) and of the *ancien régime*,<sup>5</sup> and his fief of Kirdja or Kirdja Ali, whence his ferocious irregulars, the 'Kirdjali' were recruited,<sup>6</sup> has been in its time an important Bektashi centre as containing the tomb of the saint Said Ali.<sup>7</sup>

Turning back to the Asiatic side of the Aegean, we find no clear evidence of similar combinations between dervish orders and local *beys*, though they may be suspected. In Western Asia Minor, as in European Turkey, the concentration of power in the hands of a few leading families at the end of the eighteenth century has long been remarked. The chief of these families were the Karaosmanoglou, the Ellezoglou, and the Tchapanooglou. The dominions of the Karaosmanoglou included a large

<sup>1</sup> Grisebach, *Reise durch Rumelien* (1839), ii. 230 ff.

<sup>2</sup> Jireshek, *Fürstentum Bulgarien*, 411; cf. Kanitz, *Bulgarie*, 535, for a description and legends of the *tekke*. Pehlivan Baba is mentioned in contemporary history (Jorga, *Gesch. d. Osman. Reiches*, U. 190 etc.) and in legend becomes inextricably involved in the fantastic adventures of the saint of the *tekke*.

<sup>3</sup> Kanitz, *loc. cit.*

<sup>4</sup> On Paswanoglou see Ranke, *Servia*, 487; Jorga, *op. cit.* V. 119 etc.

<sup>5</sup> For the politico-religious combinations of this period see *B.S.A.* xix. 216 ff.

<sup>6</sup> Most contemporary travellers in Rumeli mention the devastations of the 'Kirdjali' bands in the district of Adrianople and elsewhere.

<sup>7</sup> F.W.H. It would not be surprising to hear that the tomb of Said Ali was 'discovered' by a dervish in Paswanoglou's time.

portion of the present Aidin (Smyrna) *vilayet*, their capital being at Magnesia, which is only second to Konia as a centre of the Mevlevi order of dervishes<sup>1</sup>; the territory of the Ellezoglou marched with theirs on the south, occupying the present *sanjak* of Mentesh down to Budrum (Halicarnassus)<sup>2</sup>; while the Tchapanoglou, further east, with their capital at Yuzgat, governed an extensive territory, inhabited largely by semi-nomad Turcoman tribes, and including the central *tekke* of the Bektashi, in the *vilayets* of Sivas and Angora. The relations of these semi-independent feudatories were harmonious and their rule strict but enlightened, notably in the treatment of Christians, who thrived conspicuously under all three dynasties.<sup>3</sup> The power of the three governing families was broken by the centralising policy of Mahmoud II., in spite of their proved loyalty,<sup>4</sup> to the great detriment of the country.

It is tempting to suppose that at the back of this harmonious, tolerant, and (for Turkey) stable baronial government, developed simultaneously over large districts of Asia Minor, lay a secret religious organisation<sup>5</sup> with liberal principles, such as those of the Mevlevi, or such as Bektashism might have become under more intelligent and far-sighted rulers than Ali Pasha of Yannina.

F. W. HASLUCK.

<sup>1</sup> Garnett, *Women of Turkey*, ii. 438. Magnesia was also a Bektashi stronghold down to 1826.

<sup>2</sup> *Spectateur Oriental*, No. 297 (8 Dec. 1827).

<sup>3</sup> This is a commonplace in the case of the Karaosmanoglou (see especially Keppel, *Journey across the Balkans*, ii. 323). For the treatment of Christians by the Ellezoglou see Cockerell, *Travels*, 162; W. Turner, *Tour in the Levant*, iii. 10, Tchihatchef's *Reisen*, ed. Kiepert, 23; for the similar tendencies of Turkish beys of the Mylasa district Ξενοφάνης, iii. 452, Turner, *op. cit.* iii. 67. For the condition of Christians under the Tchapanoglou see Perrot, *Souvenirs*, 386: the best account of them is in Kinneir's *Journey through Asia Minor* (85 ff.).

<sup>4</sup> It is noteworthy that in 1808, when Mahmoud II. came to the throne by the deposition of Mustafa IV. (a creature of the Janissary-Bektashi combination) he had the support of the Karaosmanoglou and the Tchapanoglou (*Times*, Nov. 15, 1808, cf. Juchereau, *Hist. Emp. Ott.* ii. 247).

<sup>5</sup> Such a combination certainly existed among the Turkomans of the Angora district in the fourteenth century (*Wiener Zeitschr. f. Numis.*, 1877, 213; cf. Hammer-Hellert, *Hist. Emp. Ott.* i. 214).



## NOTE ON HAIDAR, KHODJA ACHMET, KARADJA ACHMET.

The local account of the Saint Haidar at Haidar-es-Sultan<sup>1</sup> is given by Crowfoot as follows: 'Haidar was the son of the king of Persia and came from a town named Yassevi; he was also called Khodja Akhmed and was the disciple of the famous Hadji Bektash. With the latter he travelled to Caesarea, and there took a Christian named Mēnē to wife,<sup>2</sup> and together they came to the place of his tomb, where they begat children and died—the whole village claiming descent from him.'<sup>3</sup>

The last clause makes clear the identity of Haidar as far as the village is concerned: he is their sainted ancestor. Whether, as Crowfoot suggests,<sup>4</sup> he is confused with Haidar the father (not the son) of Ismail, the founder of the Safi dynasty in Persia, is for present purposes immaterial.

The Bektashi addition to the local legend consists, as we shall see, in the identification of Haidar with Khodja Achmet Yassevi, who seems himself confounded with the Bektashi saint Karadja Achmet: both Achmets have been adopted into the Bektashi cycle.

Achmet of Yassi (in Turkestan) died in 1166–7 A.D.<sup>5</sup> and had no connection with Asia Minor or personally with Hadji Bektash, since the latter died according to generally accepted accounts—the date of his death (1337) and even his existence have been questioned<sup>6</sup>—nearly two hundred years later. Achmet Yassevi is however, irrationally represented as the (spiritual) 'Master' (not, as is said at Haidar-es-Sultan, the pupil) of Hadji Bektash and of a number of other dervishes<sup>7</sup> who can at most have been influenced by his writings.<sup>8</sup> The spiritual pedigree of Hadji Bektash

<sup>1</sup> Above, p. 98.

<sup>2</sup> The survival of the name of the wife is extraordinary. In view of the oracular well which forms the chief attraction of the sanctuary, it seems worth suggesting that the Christian occupant (real or imaginary) of the site was S. Menas, who, on account of the popular derivation of his name from *μηνύω*, is looked on by the Orthodox as the revealer of things hidden (cf. Carnoy and Nicolaïdes, *Trad. Pop. de l'Asie Mineure*, 195).

<sup>3</sup> *J. R. Anthr. Inst.* xxx. 309.

<sup>4</sup> *Ibid.* p. 311.

<sup>5</sup> Gibb, *Ottoman Poetry*, i. 71, n. 2.

<sup>6</sup> Jacob, *Beiträge*, 2.

<sup>7</sup> Evliya, *Travels*, tr. von Hammer, ii. 20; for the spiritual affiliation of Hadji Bektash to Khodja Achmet see also the 'chain' of the dervish orders by Abdi Effendi (d. 1783) in Mouradja d'Ohsson's *Tableau*, ii. pl. 102.

<sup>8</sup> This chronological difficulty is admitted by learned Bektashi; their version is that Khodja Achmet foretold the coming of Hadji Bektash and bequeathed him a book as a pledge.

from Achmet Yassevi is fostered by the Bektashi as a guarantee of their orthodoxy.

It is Karadja Achmet, not Khodja Achmet, who generally figures as the pupil of Hadji Bektash in Bektashi legend. He is mentioned by Saad-ed-din as a saint of Orkhan's reign :—'The magnificent *Carage Ahmed* descended of the offspring of several kings in the Country of Persia. After he had made a journey to the city of *Gesib*, from thence he came to *Greece* [*i.e.* Roum, Asia Minor] and dwelt in a place nigh to *Akhisar*<sup>1</sup>; his noble Sepulchre is there well-known, and is a place of visit or pilgrimage. Among the common people of the Country of *Greece* it is famous for a place of hearing prayer, and the very earth is profitable for evil diseases.'<sup>2</sup>

The seventeenth-century traveller Evliya Effendi mentions already as a fact the relation between Hadji Bektash and Karadja Achmet as that of master and pupil.<sup>3</sup> It would seem that the tomb of Karadja Achmet was occupied, like so many others, by the Bektashi in their prosperous period on the pretext that the saint was (spiritual) 'founder's kin.' Presumably under Bektashi auspices the cult of Karadja Achmet has spread widely from its original home on the Sakaria near Akhissar, where two or even three *tekkes* bear his name.<sup>4</sup> Ramsay cites three more in the district of Ushak,<sup>5</sup> and other reputed tombs of Karadja Achmet exist in the great burial-ground at Scutari near Constantinople,<sup>6</sup> and in Roumeli near Uskub at Tekke Keui.<sup>7</sup>

<sup>1</sup> The smaller of the two towns of this name, on the Sakaria.

<sup>2</sup> Seaman's *Orchan*, 120.

<sup>3</sup> He is spoken of as a Persian prince (like the Haidar of Haidar-es-Sultan) who came to the court of Orkhan, was initiated by Hadji Bektash, and at his death buried at Ak-Hissar (*Travels*, ii. 21, cf. 214; at p. 20 'Kari (*sic*) Ahmed Sultan' is said to have been one of the dervishes sent by Achmet Yassevi from Khorassan into Roum).

<sup>4</sup> (1) On the banks of the Sakaria near its junction with the Poursak (von Diest, *Neue Forschungen*, 28); (2) at Pashalar above Levke (von Diest, *Tilsit nach Angora*, 18); (3) just east of Tarakly (Skene, *Anadol*, 275).

<sup>5</sup> (1) Six hours S.S.W. of Ushak; (2) three hours N.W. of Geubek; (3) an hour from Liyen. The latter is a famous place of healing (Ramsay, *Pauline Studies*, 171). There is a village named Karadja Achmetli south of Nefez Keui (Tavium). Quite possibly the original Kara ('black') or Karadja ('blackish') Achmet was, like Haidar, an eponymous tribal ancestor, successive heads of the tribe bearing his name having been buried in various places. *Kyzyl* ('red') Achmetli was the name of a tribe settled in the Kastamouni district; divisions of the same tribe are often differentiated by colour-epithets.

<sup>6</sup> Cuinet, *Asie Mineure*, iv. 604; cp. Evliya, *Travels*, i, 81 ('Convent of Kara Ahmed Sultan'), 83 ('Convent of Karaja Ahmed Sultan'). There is now no convent attached to the tomb, which is, however, kept in repair and venerated. The Bektashi still lay claim to the saint, though this grave has passed into other hands.

<sup>7</sup> See above, No. 18.

The confusion which seems to exist at Haidar-es-Sultan between Khodja Achmet Yassevi and Karadja Achmet is found also in Evliya, who says that Achmet Yassevi, an ancestor of his own, was a *disciple* of Hadji Bektash and on the same page that Hadji Bektash was instructed by a pupil of Achmet Yassevi and married his daughter.<sup>1</sup> The error arises from the familiar confusion between two persons of the same name, in this case Achmet, borne by two eminent saints, one the alleged master, the other the alleged pupil of Hadji Bektash.

F. W. H.

<sup>1</sup> *Travels*, ii. 20.

## THE MOUNDS OF MACEDONIA.

A RECENT journey has given me the opportunity of verifying and supplementing the observations on the prehistoric sites of Macedonia made by Mr. M. S. Thompson and myself in 1909.<sup>1</sup> The following remarks are to be considered merely as notes intended to assist in the future exploration of Macedonian prehistoric mounds, as they are based on observation and not on excavation.

### I.—*The Prehistoric Mound near Serfije.*

In 1911 we noted a prehistoric settlement<sup>2</sup> on a bluff on the right bank of the Haliakmon just above the Serfije end of the bridge over the river on the Kozane-Serfije road. The mound directly overlooks the bridge-head and is skirted on the west by the high road. The fields round are known as Emir Chair. In our previous examination of the mound Mr. Thompson and I found only plain hand-made prehistoric potsherds which possessed no sufficiently marked characteristics to enable us to determine to what group they belonged. A fresh examination has resulted in the finding of sherds that are typical of the First and Second Thessalian Periods.<sup>3</sup> The following wares are represented :—

First Period, A 1, A 3β, A 3γ, A 3ε ;

Second Period, B 3γ, B 3δ ;

<sup>1</sup> *Liverpool Annals*, ii (1909), pp. 159 ff.

<sup>2</sup> Wace-Thompson, *Prehistoric Thessaly*, p. 254, note 2 ; *B.S.A.* xviii, p. 187. The town of Serfije is in Greek called Servia (Σέρβια), or vulgarly and locally Serria, but to avoid the confusion, which would be inevitable if one wrote Servia in English, it seems better to use the Turkish name Serfije.

<sup>3</sup> Wace-Thompson, *op. cit.* pp. 13 ff.

and there is one rough sherd, possibly the base of a statuette, ornamented with rows of circles impressed in the clay. Hitherto typical Thessalian prehistoric wares have not been reported further north than Ellassona,<sup>1</sup> so that these few sherds from near Serfije are important as shewing that the prehistoric culture of Thessaly extended into the Haliakmon valley. Probably further exploration will reveal other sites in the districts of Kozane,<sup>2</sup> Grevena, Kailar, and Katerine. The fact that the Thessalian culture is now known to have extended from the Haliakmon to Corinth, where the American excavators have found sherds of the Second and Third Periods in the same stratigraphical order as in Thessaly, is of great importance in the study of the early civilisation of Greece.

## II.—*The Mounds of the Salonica District.*

In this district in 1909 Mr. Thompson and I explored a large number of the various mounds locally known as *Τούμβες*.<sup>3</sup> As a result of our observations we were enabled to divide them into three classes, A, B, and C, according to their shape and character.

### TYPE A.—FUNERAL TUMULI.

These mounds are tall, steep, and conical and often as much as forty to fifty feet high. They are probably for the most part burial tumuli and have been heaped up over built chamber tombs. Of these we know the following:—

South of Salonica and in Chalcidice:—

A 1, A 2. On the left of the Vasilika road not far from Salonica.

A 3. To the east of the site of Olynthus towards the Kalyvia of Polygyros.

<sup>1</sup> Wace-Thompson, *op. cit.* p. 12.

<sup>2</sup> Arvanitopoulos (*Πρακτικά*, 1912, p. 240) reports two prehistoric mounds near Topsilar, to the east of Kozane, but the report is not yet confirmed.

<sup>3</sup> The principal references to the Macedonian Tumuli are: Chrysochoos, *Ἐπερηγίς τοῦ Παρνασσού*, 1896, pp. 9 ff.; Heuzey, *Mont Olympe*, pp. 172 ff., 200; Heuzey-Daumet, *Mission de Macédoine*, pp. 226 ff., 243 ff., 412, Pls. 15-21; Kinch, *Archaeologisch Rejse i Makedonien*, pp. 10 ff. with Plate; Körte, *Ath. Mitt.* 1899, pp. 41 ff., *Gordion*, p. 8 ff.; Leake, *Northern Greece*, iii, p. 260, etc.; Macridy Bey, *Jahrbuch*, 1911, pp. 193 ff.; Schmidt, *Zeit. f. Ethnologie*, 1905, pp. 91 ff.; Struck, *Makedonische Fahrten*, ii, pp. 46, 53, 89, etc.; Traeger, *Zeit. f. Ethnologie*, 1902, pp. 62 ff.; Wace-Thompson, *Liverpool Annals*, ii (1909), pp. 159 ff.

North of Salonica on the road to Langaza :—

A 4, A 5. On the right and left of the road just outside Salonica near the barracks.

A 6. On the left of the road not far from the top of the pass. Since we first noted this as a funereal tumulus, it has been excavated by Macridy Bey who found in it a built chamber tomb as we expected.<sup>1</sup>

West of Salonica on the road to Pella :—

A 7. On the right of the road near the military railway station ; this was excavated by Daumet in 1864 without success.<sup>2</sup>

A 8, A 9, A 10. On the hills on the right of the road not far beyond A 7.

A 11. On the left bank of the Galliko by the mills below Gradobor.<sup>3</sup>

A 12. On the right of the road just beyond the Galliko.

A 13, A 14. On the right and left of the road near Kavakli.

A 15. On the left of the road to the west of Sarija and not far beyond the branch road to Berrhoea ; this and the following nine mounds are shewn on Struck's sketch of the site of Pella.<sup>4</sup>

A16–A21. Beyond the Berrhoea road between it and Pella, five on the right of the road and one on the left. The mound nearest Pella contains the burial vault explored by Leake, Chrysochoos, and Struck.<sup>5</sup>

A 22. To the north of Pella.

A 23. At the spring called Baths or Pel.

A 24. The mound called Chekmek on the right of the road between Pella and Yenija or Giannitsa.

In Southern Macedonia :—

A 25. Near Berrhoea ; according to Traeger it belongs to this class.

A 26. Near Niausta ; explored by Kinch who has published photographs of the paintings<sup>6</sup> on the walls of the tomb within it.

A 27. At Koutles (Palatitsa) ; very large and of a slightly different type.<sup>7</sup> An uncertain number of smaller tumuli stand near it.

<sup>1</sup> *Jahrbuch*, 1911, pp. 193 ff.

<sup>2</sup> *Ἐπετηρίς τοῦ Παρνασσού*, 1896, p. 12.

<sup>3</sup> Traeger (*op. cit.* fig. 8) says it is on the right bank.

<sup>4</sup> *Op. cit.* ii. p. 88.

<sup>5</sup> *Opp. cit.*, *loc. cit.*, plans given by Leake and Chrysochoos.

<sup>6</sup> *Op. cit.* pp. 10 ff.

<sup>7</sup> Struck, *op. cit.* pp. 45 ff. ; Heuzey, *Mission de Macédoine*, p. 233, Plan C.

A 28, A 29. On the boundaries of the farms of Kitros and Eleftherochori.

A 30. Between Kitros and the sea.

A 31, A 32. South of Kitros; one of these was excavated by Heuzey.<sup>1</sup>

A 33. South of Katerine near Stipi.

A 34. Near Karista.

Formerly the current theory was that these mounds were constructed for some military purpose such as look-out stations or places from which fire-signals might be sent.<sup>2</sup> This view could be supported by the fruitless excavation of A 7 by Daumet and the fact that Sir Arthur Evans excavated another mound of this type near Uskub close to a Roman road and found no sign of any tomb.<sup>3</sup> On the other hand all the others so far excavated have proved to be funereal tumuli and to have been heaped up over elaborately decorated tomb chambers constructed of solid masonry. It seems probable, therefore, that the majority of these mounds still unexcavated are similar burial tumuli since, as shewn clearly in Struck's sketch of the site of Pella,<sup>4</sup> they are often to be found grouped round the sites of ancient cities. This view is confirmed by the excavation of similar tumuli in Thessaly where the best known is the tumulus of Pilaf Tepe on the hills between Volos and Velestinos.<sup>5</sup> Others have been excavated near Pherae (Velestinos) and near Larissa,<sup>6</sup> and near the reputed site of Argissa is a large group resembling that near Pella.<sup>7</sup> At Mousalar in Western Thessaly there is a mound of this type which, owing to an abortive excavation on the summit, now has two peaks. The natives regard these as two separate tumuli and allege that one is full of gold and the other of poisonous vipers, but since they do not know which contains the gold and which the vipers they are afraid to dig for the treasure. It is interesting that tumuli of this type are, so far, unknown in Southern Greece but are common in Thrace, especially near Philippopolis,<sup>8</sup> where one has yielded the Thracian inscription,<sup>9</sup> and Kirk Kilisse.<sup>10</sup> In the same category might be grouped the tumuli of Pergamum<sup>11</sup> and Sardis, which are

<sup>1</sup> Heuzey, *op. cit.* pp. 243 ff. Pls. 17-21; cf. *id.* *Mont Olympe*, pp. 172 ff.

<sup>2</sup> Chrysochoos, *op. cit.* p. 13.    <sup>3</sup> *Archaeologia*, vol. 49, p. 109.    <sup>4</sup> *Op. cit.* p. 88.

<sup>5</sup> *J.H.S.* 1900, pp. 20 ff.    <sup>6</sup> *Πρακτικά*, 1907, pp. 153 ff.; *Ἐφ. Ἀρχ.*, 1909, pp. 27 ff.

<sup>7</sup> Wace-Thompson, *Prehistoric Thessaly*, p. 54.    <sup>8</sup> *B.C.H.* 1901, pp. 156 ff.

<sup>9</sup> Kretschmer, *Glotta*, vi. pp. 74 ff.    <sup>10</sup> *B.S.A.* xvii, pp. 76 ff.

<sup>11</sup> *Ath. Mitt.* 1908, pp. 365 ff.

also funereal, and the famous examples round Kerch.<sup>1</sup> It is possible that since they occur throughout the area where according to ancient tradition there were Thracians—Thessaly, Macedonia, Thrace, and Western Asia Minor—it may have been a Thracian custom to erect such tumuli over the dead.<sup>2</sup> Consequently it is not surprising if they are lacking in Greece proper.<sup>3</sup>

#### TYPE B.—PREHISTORIC SETTLEMENTS.

These mounds are tall, steep, and roughly oval in shape, and some of them are as much as forty or fifty feet high. The smallest we measured was about 135 feet long by 60 feet wide. All these are prehistoric sites, though some were apparently occupied also in historic times. The great height of the mounds does not necessarily mean that the prehistoric deposit is as much as forty feet thick. Probably the prehistoric settlements were in most cases for the sake of security built on low natural rises. In the case of No. B 26 at Salamanli, half the mound has been cut away by the river, so that it can be seen in section. This shews that there are about fifteen feet of prehistoric deposit on a natural rise about twenty-five feet high. The mound at Platanaki (No. B 21) also seems to have been built on a natural knoll, to judge by the results of Macridy Bey's excavations. This easily explains the great height of the mounds and the steepness of their sides.

In 1909 Mr. Thompson and I noted the following eleven mounds of this type. This winter (January, 1915) a journey in Western Chalcidice in the region between Salonica and the site of Olynthus at Myriophyto enabled me to add fifteen more. Those so far known are these:—

On the road from Salonica to Vasilika:—

B 1. At Hagios Elias just outside Salonica; we were told that the subterranean passages mentioned by Traeger were dug by treasure seekers.<sup>4</sup>

B 2. A small mound close to the Agricultural College.

B 3. Close to the farm of Sedes.

<sup>1</sup> Minns, *Scythians and Greeks*, pp. 415 ff.

<sup>2</sup> Herodotus, iv. 95, v. 8.

<sup>3</sup> Chrysochoos (*op. cit.* p. 12) mentions many other mounds, but without exploration it is impossible to say to which class they should be assigned.

<sup>4</sup> Körte, *Ath. Mitt.* 1899, pp. 41 ff.



B 4. On the right of the road near Mejarli.

B 5. Near the baths of Sedes ; not explored.

B 6. The mound on which stands the church of Hagia Paraskeve to the west of Vasilika.

B 7. By the church of the Metamorphosis to the east of Vasilika.

In South-western Chalcidice :—

B 8. The site of Mekyberna at Molivopyrgos ; this later developed into a mound of Type C.<sup>1</sup>

B 9. The mound on the road midway between Myriophyto and Hagios Mamas.<sup>2</sup>

B 10. The mound called Gidi Dere at Yili on the boundary of the farms of Suflar and Pazalades. This was afterwards inhabited in historical times, as is shewn by the finding of Proto-Corinthian ware, black-glazed ware and late grave inscriptions and reliefs.

B 11. At Karydia (called Kardia on the Austrian Staff Map) ; this was also occupied in historic times.

B 12, B 13, B 14. Three mounds not visited ; but seen from a distance they appear to belong to this type ; they stand near the farms (*μετόχια*) of the Rossiko and Karaman monasteries.

B 15. At Verria, the site of Antigoneia according to the Austrian Staff Map ; not visited.

B 16. The mound at the site called Trapezi, Kastri or Hissar between Tsinganades and Uchevli which was mainly occupied in historic times, as shewn by the inscriptions in the Turkish cemetery near Uchevli.

B 17, B 18. Two mounds on the seashore near Uchevli and the monastery of St. Paul ; not visited, but apparently of this type.

B 19. On the hill a little to the south of Pournari Chiftlik.

B 20. In the valley of the Vasilika river near Pournari Chiftlik and opposite No. B 2.

On the road from Salonica to Langaza :—

B 21. The mound called Karaissi at Platanaki. Since we saw this in 1909 it has been partially explored by Macridy Bey. His trenches have revealed a thick prehistoric deposit with walls of mud brick.<sup>3</sup>

<sup>1</sup> Struck, *Makedonische Fahrten*, i. pp. 39, 40.    <sup>2</sup> *Ibid.*    <sup>3</sup> Cf. Traeger, *op. cit.* p. 68.

B 22. At Sarach.

B 23. On the left of the Salonica-Serres road near Guvezhne about an hour to the north of No. B 22.

On the railway from Salonica to Serres :—

B 24. At Arapli; very small.

B 25. On the left bank of the Galliko by the mills below Gradobor.

B 26. On the right bank of the Galliko near Salamanli station.

This list of course cannot exhaust the prehistoric mounds of the region in question. Many more certainly remain to be explored<sup>1</sup> and noted. For instance, a very large mound is reported at Amatovo on the line from Salonica to Nish, and several are reported round the Kara Burun headland where exploration is difficult owing to the fortifications.

The prehistoric character of these mounds seems to be beyond dispute, to judge by the potsherds which are common on them all and the excavations, unfortunately still unpublished, of Macridy Bey at No. B 21, which have entirely confirmed the opinions we had previously expressed about this site. The pottery found may be classified roughly as follows :—

(1) Undecorated wares, hand-made :—

(a) Coarse, thick reddish ware with a rugose surface. This is frequent on nearly all the sites, and at Salamanli (B 26) could be observed both at the top and at the bottom of the prehistoric deposit.

(b) Fairly well-made ware varying in colour from yellow-brown to dark brown and reddish. The shapes of the vases are unknown, but handles of a raking or wish-bone type such as have been illustrated by Schmidt<sup>2</sup> are common, and it is possible that this ware is akin to the Γ 3 β and Δ 1 γ ware of the Thessalian Fourth Period.<sup>3</sup>

(2) Decorated wares, mostly hand-made :—

(a) Hand-made incised pottery. The incised patterns are of a simple Geometric character, but the material at present is insufficient to enable any attempt to be made to ascertain the relationship of this to other northern incised wares as, for instance; those of Thessaly, Thrace and Bosnia.

<sup>1</sup> Cf. Chrysochoos, *op. cit.* p. 12.

<sup>2</sup> *Zeit. f. Ethnologie*, 1905, p. 98, figs. 6 ff.

<sup>3</sup> Wace-Thompson, *Prehistoric Thessaly*, pp. 19, 21.

(b) Hand-made painted pottery with brown-violet decoration on a brown polished surface. This is perhaps the most characteristic and easily recognisable fabric; it seems to be typically Macedonian, but some of the patterns, notably the zigzag lines, recall the B 3 ε ware of the Thessalian Second Period.<sup>1</sup>

(c) Painted pottery with black patterns on a brick-red polished surface. The patterns seem to be mainly Geometric and include devices of a chessboard type or network type. This recalls the B 3 δ and B 3 ε wares of the Thessalian Second Period.<sup>2</sup> Some sherds suggest the Δ 1 γ ware of the Thessalian Fourth Period from Lianokladi III,<sup>3</sup> and, in view of the wish-bone handles which occur in this ware at Lianokladi and in the plain wares of Macedonia, these sherds ought possibly to be separated into another class? A few pieces appear to be wheel-made but this is not certain.

(d) Imported Mycenaean pottery (Late Minoan III) of a mainland and not of a Cretan fabric. This has been found at Nos. B 2, B 7, B 10, B 11, B 16, B 21, and B 24.

(e) Painted pottery apparently wheel-made and resembling ordinary "Geometric" or Dipylon ware. The surface is rough and cream or buff in colour, with patterns in red-brown paint. It is possibly a local variant of the ordinary Geometric ware, but Schmidt<sup>4</sup> seems to have thought it an imported fabric.

(f) Pottery resembling the Γ 1 α 1 ware of the Thessalian Third Period.<sup>5</sup>

(g) Pottery resembling the Γ 1 α 3 ware of the Thessalian Third Period.<sup>6</sup>

In addition to the potsherds, celts and flint knives have been found. A flint knife was found at B 24, a celt at B 2, pieces of bored celts at B 3 and B 21, and a part of a bronze tool at B 3.

It will be seen that the most important results of the exploration of the mounds visited this winter are the finding of pottery that resembles the Thessalian wares, and the continual presence of Late Minoan III ware

<sup>1</sup> Wace-Thompson, *op. cit.* pp. 98, 103, 104, 203, Figs. 50, 53, 54, 142.

<sup>2</sup> Wace-Thompson, *op. cit.* pp. 16, 17.

<sup>3</sup> Wace-Thompson, *op. cit.* pp. 21, 185 ff.

<sup>4</sup> *Zeit. f. Ethnologie*, 1905, p. 108.

<sup>5</sup> Wace-Thompson, *op. cit.* p. 17.

<sup>6</sup> *Ibid.*

which seems to shew that the Mycenaean or latest phase of the Minoan civilisation, spread thinly over the eastern littoral of the gulf of Salonica, as in Thessaly. The publication of Macridy Bey's discoveries and careful stratigraphical excavation on other sites in the future will reveal to us more about the characteristics, the kinship, and the date of the local Macedonian wares. Not till then shall we be in a position to formulate any view about the early history of Macedonia.

#### TYPE C.—GREEK TOWN SITES.

These mounds are tall, steep, and large with wide flat tops several acres in area. They are about forty feet high and irregular in shape, and some are more than a mile in circuit. These seem to be the sites of Greek or historical towns. Of these Mr. Thompson and I explored the following:—

On the road from Salonica to Vasilika:—

C 1. At the farm of Sedes.

On the road from Salonica to Langaza:—

C 2. The large mound at Platanaki by the side of B 21.<sup>1</sup> Macridy Bey made some cuttings in the side of this.

On the road from Salonica to Pella:—

C 3. On the right bank of the Galliko near Sari Umer.

C 4. Ingliz Toumba, on the left of the road near the right bank of the Galliko.<sup>2</sup>

C 5. By the station of Topji (Topsin).

On the railway line from Salonica to Serres:—

C 6. On the left bank of the Galliko by the mills below Gradobor; the cone at the south end of this seems to be natural.<sup>3</sup>

C 7. On the right bank of the Galliko near Narash.

To these we may add in Chalcidice:—

C 8. The mound by the church of Hagia Paraskeve in the valley below Galatista. This is the reputed site of Anthemous.<sup>4</sup> The church of

<sup>1</sup> Traeger, *op. cit.* Fig. 5.

<sup>2</sup> Traeger, *op. cit.* Fig. 6: placed by him on the left bank.

<sup>3</sup> Traeger, *op. cit.* Fig. 9: placed by him on the right bank.

<sup>4</sup> Δημόστρας, *Μακεδονία*, pp. 604, 641 ff.

Hagia Paraskeve contains inscriptions presumably found on the site and there are others from the neighbourhood in Galatista village.

C 9. The mound on the left bank of the river opposite Myriophyto which is in all probability the site of Olynthus.<sup>1</sup> Marble blocks, worked stones and inscriptions from the site are built into houses in Myriophyto, and vases and terracottas are found by peasants on the site.

C 10. The mound of Molivopyrgos (B 8), the probable site of Mekyberna.<sup>2</sup> Large clamps or rivets and sling bullets of lead are frequently found here; hence the modern name of the site.

The mounds at Sufilar, Karydia, and Trapezi (Nos. B 10, B 11, and B 16), where prehistoric sites were reoccupied in historic times, might almost be classed with the mounds of Type C, but local conditions apparently were not favourable to the formation of mounds of this type.

That these mounds of Type C are the sites of Greek or other towns of historic times can hardly be doubted in view of the inscriptions from C 8 and C 9 and the historical and topographical evidence about the identification of C 9 and C 10 as Olynthus and Mekyberna. Further, the pottery to be found on these sites is a clear indication of their date, as can be seen in Macridy Bey's trenches in C 2. Hand-made wares of a prehistoric type are rarely, if ever, to be found, and the earliest definite fabric is Geometric. Then, in succession, on these and kindred sites, we find Proto-Corinthian, black-glazed ware of the fifth and fourth centuries, Megarian bowls, and various Hellenistic wares from black-glazed sherds with stamped patterns, to glazed red ware akin to Samian. The one constant and most striking feature of these mounds, apart from their broad level tops, is the occurrence here and there round the edge of sloping paths which may indicate the site of entrances. As in the case of the prehistoric mounds it must not be assumed that they are built up entirely of debris for, as is clearly seen at Olynthus (C 9) and in Macridy Bey's trenches in C 2, the towns were in every case built on a natural rise. It is to be hoped that it will not be long before one of these sites is systematically excavated.

A. J. B. WACE.

<sup>1</sup> Struck, *Makedonische Fahrten*, i, pp. 38 ff.; Chrysochoos, 'Ἐπιπέρις τοῦ Παργασσοῦ, 1899, pp. 142 ff.

<sup>2</sup> Struck, *op. cit.* i. pp. 39, 56.

## ANNUAL MEETING OF SUBSCRIBERS.

---

THE Annual Meeting of Subscribers to the School was held in the rooms of the Society of Antiquaries, Burlington House, on Tuesday, October 25th, 1914, MR. GEORGE A. MACMILLAN, Chairman of the Managing Committee, presiding.

The Secretary of the School (MR. J. ff. BAKER-PENOYRE) submitted the following report on behalf of the Managing Committee for the Session 1913-1914.

In presenting the following Report on the work of the School for the Session 1913-14, the Managing Committee beg to submit that it is their duty in the grave national crisis to continue the work of the School so far as is consistent with public obligations. They anticipate that the number of the students will be extremely small, as many have undertaken military service.

They have learned with regret and pride of the gallant death of Captain K. T. Frost of the Cheshire Regiment, Student of the School 1902-3, to whose family they have offered an expression of most sincere sympathy on the part of the School.

The Session just concluded brings to an end Mr. R. M. Dawkins' long and distinguished tenure of the Directorship. He was first appointed in 1906, and has been twice reappointed since. Both as philologist and archaeologist Mr. Dawkins has brought honour to the School, while his personal qualities as Director, colleague, and friend have endeared him to all. In the opinion of those most competent to judge, his excavations at Sparta attained the highest possible level of scientific accuracy. The Committee are glad to learn that his philological researches, the prosecution of which has prevented him from accepting a further term of office, will take him frequently to Greek lands and keep him in touch with the School. They have recently created him an Honorary Student of the School, and he has accepted a seat on the Managing Committee. They learn with pleasure of a continual improvement in the health of Miss Dawkins, to whom the School owed much during the years when she was able to reside in Athens.

In nominating Mr. A. J. B. Wace as his successor the Committee feel confident that the high traditions of the Directorship will be ably maintained. For the past twelve years Mr. Wace has been closely associated with the School, and, when called on to make the appointment, the Committee were particularly struck with the wide range of the studies in which he had achieved distinction. This is indicated by his published work which ranges from an original and successful book on the prehistoric antiquities of Northern Greece to studies in Hellenistic and Roman art and papers on the present culture and ethnology of the Balkan peoples. The appointment is an acceptable one in Greece where Mr. Wace has many friends among the Greek archaeological authorities and in the Foreign Schools.

Mr. Walter George, a former student of the School and a distinguished Byzantine archaeologist, has accepted nomination for a seat on the Managing Committee.

**The Director.**—Shortly after the opening of the Session Mr. Dawkins went to Crete to prepare the publication of the objects found in the previous session at the Kamares Cave. He made a further series of coloured drawings of vases to illustrate the report and prepared the necessary plans. Before returning to Athens, he visited the site of Pláti in the plain of Lasíthi, which was suggested to him by Dr. Hatzidakis as a possible field for an excavation. His report on the prospects of this site led the Committee to sanction the scheme for the excavation which was carried out in the spring. He then returned to Athens, and in the early spring paid a short visit to Constantinople. At the end of March he went to Crete to carry on the excavation at Pláti, where he remained until the end of May. June was spent in Athens, and at the end of the month he left for a journey in Pontus. At Athens he read a paper at one of the open meetings of the School, prepared the publication of the Kamares Cave excavation, wrote for the *Annual* a paper on a series of Early Fonts and Baptisteries in the Aegean area, and translated Dr. Hatzidakis' paper on the excavation of the cave at Arkalokhóri in Crete, which appears in the *Annual* for the year. He also took his share in the editing of the just-published volume of the *Annual*, and corrected proofs of a volume which will shortly appear, on the Modern Greek dialect of Asia Minor, the fruit of work which began as long ago as 1909. At the close of the session he went to Trebizond for the purposes of linguistic study and remained in the district until the middle of August, visiting the Greek-speaking districts of Súrmena, Ophis, Sánta and Krómni.

**The Assistant Director and Students.**—Mr. F. W. Hasluck, M.A., Librarian and Assistant Director of the School, arrived in Athens at the opening of the Session, and remained there continuously throughout the winter with the exception of a short visit to Paros. This expedition was undertaken on behalf of the Byzantine Fund, which is about to publish a volume on the Church of the Virgin of the Hundred Gates at Paroekía; to this volume he is contributing the sections on the history and inscriptions of the church. During the winter he was employed

mainly in research on (1) various subjects connected with the folklore and religion of Turkey, and (2) the later history of Smyrna. He read a paper at the first open meeting and prepared several articles for the *Annual*.

In the spring he visited Smyrna and Constantinople in connection with the work named above. In Constantinople he began cataloguing the Frankish monuments of the Imperial Museum, and, thanks to the courtesy of Edhem Bey of the museum staff, received exceptional facilities for visiting the 'Mosque of the Arabs' in Galata, then in the hands of the *Evqaf* for repairs. In the course of these repairs were found a number of unpublished grave-slabs of the Genoese period with heraldry and inscriptions, which Mr. Hasluck hopes to include, on their removal to the museum, in the catalogue of Frankish monuments.

Later in the year he visited in Thessaly the Meteora monasteries, Porta, Trfkala (Tricca), Velesfno (Pherae), Lárissa, Tempe, and what is probably the last dervish monastery existing in 'Old' Greece, the *tekke* of Turbe-Ali, near Aivali. Proceeding to Macedonia he visited Salonika, Monastir, Ochrida, the monastery of S. Naoum, Perlepe, Uskub, Kalkandelen, Philippi, and Kavalla, studying particularly Turkish popular religion and folklore. On his way home he again passed through Macedonia visiting several of the Serb monasteries.

Mr. J. P. Droop, M.A., spent the winter in Crete working on behalf of Sir Arthur Evans. He came to Athens early in March, and in April, returning to Crete, joined the excavating party at Pláti where he remained until the end of the work, leaving Athens on June 6th. Whilst in Crete Mr. Droop paid a visit to Mr. R. B. Seager at Pakhýs Ammos and visited the excavated sites of Gourniá, Pseíra and Vasilikí.

Mr. C. A. Scutt, B.A., Clare College, Cambridge, George Charles Winter Warr Scholar of the University of Cambridge, came to Greece for a second year to continue his study of the Tsakonian Dialect, the first part of which is being published in the *Annual* of the School. He passed through Rome, and then spent a fortnight studying the dialect of the Greek-speaking villages of southern Italy. He visited practically all the Greek villages both of the Terra D'Otranto and in the Bova district in Calabria, paying special attention to the phonetics. He reached Athens on November 7th, and spent the greater part of the winter and spring in the preparation of his paper on the Tsakonian dialect. He supplemented his previous work by a complete tour of the Tsakonian area of Kynouria, recording the dialect and securing a series of texts of folk-tales as material for study. Besides this linguistic work he travelled in the Peloponnese, visiting Sparta and Mistrá and the American excavation at Corinth. He also travelled in Crete in February, visiting Knossos, Gortyn, Phaistos and Rétimo, and from May 15th was present at the excavation of Pláti. By these journeys in Crete he increased his practical knowledge in his special subject of Modern Greek, and also gained some experience of excavations.

Mr. S. Casson, B.A., Senior Scholar of St. John's College, Oxford, came to Greece in December, after spending some time in the study of sculpture at Paris and Bologna. He remained in Greece until the end of March, for the most part



at Athens, working on the *Catalogue* of the Acropolis Museum. He visited Lamia to study the topography of Oeta, and also visited Megara and Marathon. The results of the studies were given in a paper read at an open meeting of the School. In the *Annual* he published a paper on the Baptistery of Kepos in Melos. He returned to England by way of Salonika and Belgrade, staying a short time in Paris to work on some minor points connected with the Parthenon Marbles.

Mr. M. L. W. Laistner, B.A., Jesus College, Cambridge, School Student, came to Greece at the end of November, and went almost at once to Crete. Here he worked in the Museum at the publication of the finds from the Kamares Cave. He then studied at Athens the early history of colonisation in Asia Minor, and the archaic pottery of Ionia. He visited Delphi in connexion with his work on Geometric pottery, and published the result in a paper in the *Annual* on the Geometric ware found at Delphi. He then assisted at the excavation at Pláti, and after a short stay at Athens returned to England by way of Constantinople. Mr. Laistner has since been appointed Lecturer in Greek in the University of Birmingham.

Mr. R. M. Heath, B.A., Oriel College, came out to Athens in December as holder of the Oxford University Craven Fellowship. He studied epigraphy in the Epigraphic Museum, and worked at the inscriptions of the Knidian Chersonese in preparation for the proposed excavation at Datcha. He paid two visits to Salamis and Megara, investigating especially the topography of Nisaea and Minoa, on the latter of which he copied an unpublished inscription, three proxeny-decrees of Megara. He went to Delphi, and travelled in Crete, visiting Knossos, Gortyn, Phaistos, and Hagia Triada. He also visited the South of Euboea (Karystos and Mount Ocha). He then went again to Crete and after a week in the Museum at Candia, went up to Pláti and was present during the greater part of the excavation. On returning to Greece he went round the Peloponnese, and saw Olympia, Bassae, Sparta, Argos, Mycenae and Tiryns. He then went to Mykonos and Delos, leaving Greece at the end of June.

Mr. J. Boxwell, Scholar of Trinity College, Dublin, B.A. of the University of Cape Colony, was given a travelling scholarship by the Union of South Africa at the end of 1913, to study in Greece and Italy. His plan was to visit the chief sites of historical and archaeological interest, and also to see something of the methods of teaching ancient Greek employed in modern Greece. Thus in Northern Greece he visited the sites of Kirrha, Delphi, Amphissa, Thermopylae, Haliartos, Orchomenos, Thebes, and in the Peloponnesos, Mycenae, Tiryns, Argos, Epidauros, Sparta, Olympia and Corinth. He spent about three weeks in Crete, about half of which was at the excavations of the British School at Pláti, visiting also Goulás, Gortyn, Phaistos, Hagia Triada, and Knossos. Of the islands he visited Delos and Mykonos. With regard to the teaching of Greek Mr. Boxwell reports:—"In Athens and the country districts I visited several elementary and secondary schools. I was particularly anxious to see to what extent it was possible to teach ancient Greek orally by methods somewhat similar to those employed in teaching modern

languages, and how far translation could be dispensed with. The impression I received was that the oral method was used fairly extensively and added much to the interest of the lesson. I feel certain that boys to whom the written language of Modern Greece is familiar have a great advantage in studying ancient Greek. In one of the secondary schools in Athens I was much impressed by the rapidity and ease with which young boys seemed to read a difficult author like Aristotle. The methods employed did not perhaps tend to the production of accurate and thorough scholarship—no particular attention was paid to minute points of grammatical niceties. I attended one interesting lesson in oral composition. A paragraph was slowly and carefully read aloud two or three times, books were then put away and the boys repeated the subject matter in the words of the ancient author. On the whole, what I saw of the teaching of Greek in this country seemed perhaps not calculated to produce much in the way of mental discipline, but the ease and rapidity with which a large extent of ground was covered was, I thought, certain to produce a genuine liking for the study of the classics.”

Mr. J. Arnott Hamilton, M.A., of the University of Edinburgh, came to Greece on the Blackie Foundation. In pursuance of the intention of the founder, he acquired a knowledge of Modern Greece by attending the lectures at the University of Professor Adamantiou on Byzantine subjects, and also made a study of Byzantine ecclesiastical art. For this purpose he visited Daphne, Hósios Loukás, Mistrá, and other buildings, and made a special study of the history and eikonography of the Monastery of Kaisariané on Mount Hymettos. He was in Greece from the middle of November to the first week in February.

Miss D. Lamb left England in January and spent a fortnight in Paris working at Geometric and Ionian vases. She spent February in Rome making a study of Christian mosaics and March in Athens, revising at the request of the Committee, the catalogue of the Acropolis terracottas which had been finished in 1912. In April she went to Nauplia to see the Tiryns terracottas for purposes of the catalogue. She spent a fortnight in Constantinople visiting museums and paying special attention to Byzantine and Ottoman arts and architecture. She returned to Athens, by a route which included Broussa, Smyrna, Sardes, and Ephesus, and worked on the bibliography of Mussulman, and in particular Seljuk, art. She later went to Konía, where she studied the Seljuk buildings.

Miss M. N. L. Taylor, of Newnham College, Cambridge, arrived in Greece early in November, and almost immediately went for a tour in the Peloponnesus, visiting the well known sites. She spent the winter mostly in Athens, where she studied the museums and monuments generally. In January she went to Delphi, and in February to Crete, visiting the Minoan sites. In March she left Athens, and after visiting Olympia and Corfu went to Rome, where she stayed till the end of June working principally at Italo-Greek terracottas.

**Excavations.**—When the Director was in Crete in the winter, a report was made to the Cretan authorities that a Minoan site had been discovered by the villagers of Pláti, a small place at the edge of the Lasíthi plain in the Dikté

mountains, a short way to the west of Psykró. Dr. Hatzidakis, Ephor of Antiquities in Crete, suggested that it might be visited, and after this preliminary inspection the School applied for and was granted a permit for an excavation. This was carried out between April 25th and May 27th, the Director being in charge, and assisted by Messrs. Droop, Laistner, and Heath.

The results were, briefly, that a Minoan settlement was uncovered at the site called Τὸ κάτω κεφάλι, a knoll of ground projecting into the plain of Lasíthi. The settlement yielded finds ranging in date from Late Minoan I to Late Minoan III, and thus covers the same period of time as the native offerings found in the Diktaean cave at Psykró. There is thus every reason to suppose that the town connected with the cult of the cave lay at Pláti. Just as at the cave a certain number of objects of the Greek period were found, so too a part of the Minoan Settlement of Pláti was overlaid with the scanty remains of the archaic Greek houses. This upper stratum yielded a quantity of fragments of the characteristic pithoi with impressed ornaments and a series of plain vessels of domestic use.

On the Minoan site there was a clearly marked Late Minoan I stratum which yielded a finely painted oinochoe of characteristic style. The principal remains were, however, Late Minoan III, and these present the finest example of town-planning yet found in Crete. Three large blocks of buildings were found, arranged to form three sides of a square. It is unfortunate that the site has been much pillaged for hewn stone,—the village of Pláti is probably largely constructed from the spoils of the ancient town,—and only one of the three blocks was at all well preserved. This, however, shows an interesting house with a double portico and square column-bases, and an interior courtyard. That some interval elapsed between the Minoan and Greek periods is indicated by the fact that the Greek walls entirely disregard the Minoan plan, and in fact occupy a part of the enclosed square, which in Minoan times was an empty space.

The house clearly occupied an area considerably larger than that of our excavation, but the other houses seemed so much destroyed as hardly to be likely to repay the labour of uncovering them.

The cemetery lay on the sides of the valley which runs up into the mountains behind the modern village. A beehive tomb was discovered and excavated. It contained a clay larnax and bones, and two small vases. It is to be dated late in the Late Minoan III period.

**The Library.**—The resources of the library have been increased by the addition of seventy-nine complete works, thirty-five volumes and parts of works in progress, forty-two pamphlets, and two maps.

The list of periodicals has been increased by the addition of the *Archiv für Religionswissenschaft*, of which a complete set from the commencement has been purchased.

The School is indebted to the following for presents of books:—Archäologische Gesellschaft, German Archaeological Institutes at Athens and Rome, British Museum Trustees, Cambridge University Press, Ἐκπαιδευτικὸς Ὀμιλὸς (Athens),

Μοναστηριακή Ἐπιτροπή (Candia), Oxford University Press, H.M.'s Government of India, H.M.'s Government of Cyprus.

The following authors have been good enough to present copies of their works :—Mrs. R. C. Bosanquet, Prof. Bury, Mr. F. M. Cornford, R. P. Hippolyte Delehayé, S.J., Dr. A. Elter, Mr. W. S. George, Dr. A. Giannopoulos, Mr. W. R. Halliday, Mr. H. C. Lukach, Prof. A. van Millingen, Prof. W. C. Michaelides (Robert Coll., Constantinople), Prof. L. Milani, Dr. A. Momferratos, Prof. F. von Reber, Dr. G. Soteriades, Dr. Svoronos, Dr. M. Triandaphyllides, Mr. M. N. Tod, Prof. P. N. Ure, Mr. P. Vlásto.

Messrs. Macmillan and Messrs. Longmans, Green and Co. have kindly presented works published by them.

Donors of miscellaneous works are :—Mr. J. Bouchier, the Director, Rev. Prof. Hechler, Miss C. A. Hutton, Professor Kerr, the Librarian, Mr. D. P. Petrococchino, and Mr. H. Pirie-Gordon. The Librarian also gratefully records gifts in money for the Library from the Hon. H. H. Hobhouse and Lady Evans.

Twenty-five persons outside the immediate circle of the School have borrowed books. Three of these were members of foreign schools. The section in the library dealing with mythology and religion has been considerably enlarged and in consequence re-arranged, and a reorganisation of the map section, which will involve fresh cataloguing, is in progress.

**Open Meetings.**—Two open meetings were held in the course of the Session. the *Acta* being as follows :—

January 30, 1913.—Mr. R. M. Dawkins : *The Excavation of the Kamares Cave in Crete.*

Mr. F. W. Hasluck : *Graves of the Arabs in Asia Minor.*

March 6, 1913.—Mr. S. Casson : *Notes on Thermopylae and Marathon.*

Mr. C. A. Scutt : *The Tsakonian Question.*

**Acknowledgements.**—In the course of this report acknowledgement has been made of much valued help given in various directions, but the thanks of the School are due in an especial degree to H.B.M.'s Minister at Athens, Sir Francis Elliot, for many acts of kindness ; to the Greek Government for its friendly attitude and continued support ; to Dr. V. Leonardos, the chief of the Archaeological department, Dr. V. Staïs, Ephor of the National Museum, and Professor Soteriades, Ephor in charge of the Acropolis ; to many Ephors of the provinces ; to the Archbishop of Trebizond, his clergy and the Greek Community in general for hospitality and help given to the Director during his visits there, and also to the Consul for the United States at Trebizond for his help and diplomatic support ; and once more to Miss C. A. Hutton for editing the *Annual* of the School.

**Finance.**—The Revenue Account for the year shews a Credit balance of £62 10s. 4d. as compared with a similar balance of £136 6s. 2d. for the preceding year. The total of the Annual Subscriptions is only £772 6s., which shews a

falling off of £45 as compared with last year, and more than £80 as compared with two years ago.

It is most desirable in the interests of the School that this falling off should be arrested at once. In the national crisis it would be unbecoming to make any appeal for funds or for fresh subscribers, but the Committee trust that, so far as is consistent with public obligation, existing subscribers will do what they can to keep the School together.

The cost of the publication of the *Annual* is less by £99, while the sales shew an increase of £17.

The Chairman having commented on the Report moved its adoption, which was seconded by DR. LEAF. The motion having been put to the Meeting was carried unanimously.

DR. LEAF moved that MR. W. S. GEORGE be elected a member of the Committee, and that PROFESSOR BOSANQUET, PROFESSOR J. L. MYERS, and MR. WHIBLEY, retiring under Rule XIII (3) and being eligible for re-election, be re-elected on the Committee. That MR. V. W. YORKE be re-elected Hon. Treasurer. That MR. J. ff. BAKER-PENOYRE be re-elected Secretary; seconded by MR. DAWKINS and carried unanimously.

A vote of thanks to the Auditors, MESSRS. PRICE, WATERHOUSE, moved by MR. YORKE and seconded by MR. PENOYRE, was carried unanimously.

At the special meeting convened for 5 p.m., the MASTER OF UNIVERSITY COLLEGE, OXFORD, occupied the chair and, being introduced by MR. GEORGE A. MACMILLAN, delivered an address.

DR. MACAN said:—

Have the subscribers to the British School at Athens ever met, during the eight and twenty years of its existence, under more anxious and sombre conditions than those in which we find ourselves to-day? Even in last year's Report our Committee had to record "trouble for the countries where the work of the School is carried on": this year the trouble is immensely aggravated and spreads over countries and nations which support the School and other similar institutions in Athens—and not over them only: the trouble is truly of oecumenical proportions—there is hardly a people on the face of the earth, there is hardly a corner of the habitable globe, unaffected by the present war. We may apply to it what Thucydides says of the Peloponnesian war in 431 B.C.: *κίνησις γὰρ αὐτῆ μεγίστη δὴ τοῖς Ἑλλησιν ἐγένετο καὶ μέρει τινὶ τῶν βαρβάρων, ὡς δὲ εἰπεῖν καὶ ἐπὶ πλείστον ἀνθρώπων* (a 1, 2); that is, in plain English: There never was so great a commotion in Hellas as this

war, and it affected non-Hellenic nations to some extent, and one might almost say mankind at large. We need only substitute Christendom for Hellas in this passage to clinch the parallel. We at any rate find ourselves face to face, in the measured language of this year's Report, with 'a grave national crisis.' Yet one and all will applaud the Committee's resolution 'to continue the work of the School so far as is consistent with public obligation'; and we, subscribers, must do what we can to back our Committee, hoping that public duty, whether of personal service or of financial aid, will not force us to forget those classic studies which the British School at Athens has so efficiently laboured to promote:—will not compel us to diminish our contributions for the maintenance of the School as an organ of education and research, the value of which for our national culture can hardly be exaggerated. Indeed, a melancholy feature of this year's Report is that it makes no special appeal for funds; but all friends of the School will desire that the Committee be enabled to carry on the business of the School as usual, to maintain the premises, to continue the administration, and to have something in hand, against the return of happier days—and which of us doubts the dawn of a happier day?—for a fresh and vigorous start on a peaceful campaign of exploration and study in Hellenic lands.

This is not exactly the moment which one would have chosen for a change in the Directorship of the School. Such a change at such a moment might seem like an added embarrassment to the Committee and the School. But none will grudge Mr. Dawkins his well earned emancipation, which was arranged long before the present crisis was in being, or was foreseen. I do but voice the general opinion if I say that, of the distinguished men who have occupied the post of Director of the School, as none has exceeded Mr. Dawkins in length of service, so none has deserved better all round of students, subscribers and friends. Mr. Dawkins is the last man in the world to blow his own trumpet, or to forgive me, were I to sing his praises as I am tempted to do: I will therefore say merely that I caught with great pleasure the 'personal note' in our Committee's farewell to him as Director, and add that the one thing not to be forgiven him in that capacity is to have set a standard which may make things harder for his successor. Yet here again is our Committee to be congratulated—and we congratulate ourselves—on finding so true and tried a veteran of the School as Mr. Wace willing to take up the onerous post of Director at this crisis. Mr. Wace's name has long been familiar even to those of us who know him only, or chiefly, from the annual Reports and Records of the School; but those sources are enough to assure us that we may heartily re-echo the confident judgment of our Committee that in Mr. Wace's hands 'the high tradition of the Directorship will be ably maintained.' Our Committee, in assaying Mr. Wace's merits, has been struck 'with the wide range of the studies' which he has pursued during his ten years' association with the School. I had seen the draft Report before that introductory paragraph was prefixed to it, and had already formulated in almost identical terms my own impression of the character of the work recorded for the School as a whole during the season under review: that work really covers a remarkably 'wide range.' The archaeological note must ever

be the key-note of the harmonious movement of the School ; but we cannot expect a Knossos, or a Phylakopi, or a Sparta, every year ; and this year's Report is perhaps less dominated by the archaeologists than is usual in our hardy Annuals. Mr. Dawkins will, however, presently show us the spoils of a Minoan settlement at Plati in Krete, which will be enough to prove that the School spade was not idle during the past session. Nor do our archaeologists confine themselves to Minoan and Hellenic remains, but range freely over Byzantine, and Frankish and other materials. The line between archaeology and art is evanescent ; the epigraphist comes in to complete the bridge between inarticulate evidence and the conscious word, for which numismatic may have laid a foundation. With epigraphy the language and literature are already within sight and hearing. As Greek is the one language of ancient Europe which has never died, we need not be surprised to discover Mr. Dawkins engaged in correcting the proofs of a volume on the modern Greek dialect of Asia Minor, or to find Mr. Scutt going out for a second year to continue his study of the Tsaconian dialect, or to learn that Mr. Hamilton of Edinburgh, a student on the Blackie foundation, set to work, 'in pursuance of the intention of the Founder,' to acquire a knowledge of Modern Greek. What other pursuit would anyone expect, who can remember that most picturesque of Professors with his enthusiasm for the living language of Greece and for oral methods of instruction ? That there was common sense in his enthusiasm and no mere fallacy of *Hysteron Proteron* may be inferred from the very interesting paragraph in the Report, which summarises the results of Mr. Boxwell's observations upon 'the methods of teaching ancient Greek employed in Greece to-day.' A problem of 'paidagogic,' the science or art of education, is here presented, under the aegis of our 'High School,'—as I make bold to call it—and we dip, with Mr. Boxwell's leave, into the 'elementary and secondary schools' of the Hellenic kingdom, and assist at lessons in ancient Greek, conducted orally 'by methods somewhat similar to those employed in teaching modern languages.' The moral is writ large : 'boys'—(and if boys, why not girls too?)—'boys to whom the written languages of Modern Greece is familiar have a great advantage in studying ancient Greek.' This sentence would have been a joy to Professor Blackie ; and it may be commended to the attention of members of the Classical Association, the Council of which is understood to be considering this very question of the methods of oral instruction as applicable to the classical languages. The fact is, your quick Hellenist is a modernist of the moderns : a truth which I never weary of proclaiming, and for the reality of which I am constantly finding fresh evidence. So I, for one, am simply delighted to hear that our Librarian, Mr. Hasluck, employed his winter leisure in researches not merely in 'the later history of Smyrna' but also on 'various subjects connected with the folklore and religion of Turkey.' The wind bloweth where it listeth, and if you start a lively set of original researchers at work in the Levant, there's no knowing whither they may not carry you !

Nothing, however, in the Report appeals more directly to my own personal predilections than do the indications afforded of the value to the humble historian of intelligent travel, of mere inspection of the classic scene, exploration of the ORBIS

VETERIBUS NOTUS, acquaintance with the sea and sky and soil of Greece. How welcome the opportunity 'to transfer' goodly sections of storied earth and water, 'from the the map to the mind'! How great the joy of experiencing 'the dream of study dissolve in the reality of vision'! I cull these happy phrases from that lively and enchanted record of *ÆGEAN DAYS*, not long since penned by Professor Manatt and published by Mr. Murray, in Albemarle Street hard by. Who that has known such transfers, such vision, can fail to appreciate their utility and delight? The value of purposive travel for the scholar, the historian, the dilettante—he too has a right to exist—can hardly be overestimated. The pity is that still comparatively few of those who might use and enjoy it, have risen to their opportunities. If all those who might visit Greece with profit and with pleasure would only do so, the British School at Athens could never be in want of friends or funds! I had thought to take this 'purposive travel,' or something of the sort, as text of my address to you here to-day, and to point the contrast between existing facilities for such travel and the meagre opportunities of my own early manhood, when first I set my face towards Hellas and Hellenic ways. *Et ego in Arcadia!* Forty years ago and more, in 1873, with a dear friend and brother Oxonian, I spent five golden days in Attica. We counted it worth while to fare from Brindisi to Peiræus and back all the long way from Peiræus to Venice, over the salt but sapphire seas, for the chance of a vision;—and we were not disappointed of our hope! I date my own devotion to Apollo and the Nine—such as it has been—to that venture. But there was no British School at Athens in those days. The tower of the Franks still dominated the Akropolis. The so-called Theseion concealed a few antique marbles—I remember there in particular the Triptolemos—you might see them in dust and disorder, if you could find the custode, and persuade him to unlock the wicket. We drove to Eleusis, under protection of a cavalry escort—the Vyner tragedy was still fresh in men's minds. Schliemann had, indeed, already begun his devastating assault on Troy, though I doubt if anyone in this country had heard thereof: you know how that modern siege lasted, say, thrice as long as the ancient one, poor Schliemann himself not living to sing the true *Iliou persis*. But in the early seventies we were just on the eve of the marvellous renaissance and resurrection of ancient Greece, due chiefly to the spade, which has given new life to Hellenic studies, and secured for classic culture an interest, both more widely diffused and more intelligent, than it ever enjoyed before, at least in these northern latitudes. In later years, and so long as it was my duty and privilege to represent in a special degree the interests of Greek History in Oxford, I never grudged time or means to extend and enrich my visual knowledge of the native scenes and material environment of ancient history; but it was never in my power to remain in Greece for more than a few weeks at a time, and I constantly envied—in an ungrudging spirit—the ever increasing advantages for travel and study in Greek lands, which the younger generations of scholars were coming more and more to enjoy. In my old age I am grown a fanatical advocate of the *Wanderjahr* or *-jahre* in Greece and Italy, for every student who would quicken in himself a fuller understanding of ancient life and culture: and all the more, if he propose to lead others in the



way. And such students, such travellers, have had, we know, in the British School at Athens, a hearth and home, where they could find the sacred fire ever burning, and receive encouragement, instruction, direction, with—I fancy—a maximum of kindness, and a minimum of discipline.

But a panegyric on foreign travel of any kind must at the present crisis appear a sort of anachronism. The war is in all our thoughts, and has made the works and days of peace mere memories—and hopes. Our Committee's touching notice in their Report of the gallant death of Captain K. T. Frost, of Brasenose College, who held the Oxford Studentship at the School some thirteen or fourteen years ago, sets us face to face with the sternest realities of this hour. And my mind has been turned aside to review—half indignantly and half in irony—the cruel yet cathartic tragedy of this universal war in the light of my ancient history. How humane and chivalrous appears that old Greek warfare, from Achilles to Alexander, beside these modern Minotaurs! Warriors no longer wield weapons but employ engines, nay rather, are employed by them: the man is part and parcel of the machine, *emp-suchon organon*, the slave of his own monstrous manufactures! The practice of warfare seems to have gained very little of nobility or of philanthropy in the transit from ancient to modern times, from Hellas to Christendom. The Greeks were a *Kultur-Volk* and the Greek Polis was a *Kultur-Staat*, if ever there was one; and they claimed, through the lips of Aristotle, all but their wisest man, to enslave the rest of the world in virtue of their racial and cultural superiority. I have sometimes smiled to remember what Aristotle's own status would have been, some two or three centuries later, as the learned slave of your luxurious or leisured Roman, a Cicero, a Seneca, at once lord and lover of Hellenic culture. There is little in the latest theories of peace and war, of the State and the Soul, which we may not find anticipated in ancient Greece. The Greeks plainly regarded the normal relations of independent autonomous sovran communities, in a word 'States,' one with another, as relations of manifest or of veiled hostility: their curious practice of concluding treaties of peace for limited periods, five, ten, thirty years—the last figure far too good to be true—implies as much. Prussian state-craft is historically affiliated through Treitschke, Hegel, Frederick, Machiavelli, upon Thucydides and the Greek Sophists. The analogy between Prussian devilry and the Melian Dialogue has lately been elucidated by two Oxford savants independently, by Mr. Conybeare in a letter to *The Spectator* of August 15, and by Mr. Barker in his brilliant pamphlet on Nietzsche and Treitschke. The doctrine that 'Might is Right' as rationale of the *Bellum omnium inter omnes*, whether the units be states or individuals, is the marrow of the Athenian argument at Melos as of the Prussian apology for Louvain; and with exquisite irony Thucydides inserts that sophistic ultimatum from the Athenian bully as Prologue to the story of the too ambitious adventure in the West which prepared the downfall of the Tyrant-city. No one quite fully understands the lesson of the Peloponnesian War, as narrated by the didactic historian, if he thinks it mainly a colonial and commercial war between Corinth and Athens, or a politic and imperial war, between Athens and Sparta: above and before all it was a trial of strength between rival cultures, or types of

culture, the Spartan, which had many admirers in Athens itself, the Athenian, which at any rate on the showing of Thucydides—think only of that Pharisaic Funeral Oration put into the mouth of Perikles—had certainly a pretty good conceit of itself. But a point to observe is that these typical and rival cultures, the Athenian, the Laconian, diverse and alternative as they were to each other, were both essentially Hellenic, and fell within the definition of Hellenism: they had more in common with each other than either would have—shall I say?—with ours, or with any known form of Christendom. Not that they were compatible: they cancelled and destroyed each other, as might Plato and Aristotle. It was Coleridge, you will remember, who said that every child of man is born either a Platonist or an Aristotelian: but the dilemma is not quite exhaustive or convincing, for Plato and Aristotle, just like Sparta and Athens, had more in common with each other than we have with either of them: still, if a modern must choose, he might well elect to err with Plato, who was much more concerned for man's immortal soul than for any temporal polity. Aristotle, however, shared with Thucydides the illusion that the Greek City-State was the final organ of culture, and devised an ideal State on the lines of a reformed Athens, as a model for legislators. With unconscious irony the sage propounded this ideal as practical politics at the very moment when the autonomous Greek City-State was virtually played out, and History was on the move to a larger goal. His illusion was not unlike Hegel's latter-day discovery that only the State has a history, and that the last word of modern history is the Prussian State. But we to-day see history still in the making, and Aristotle had witnessed the downfall of Sparta, and at least knew that war and warfare, war ethics and war politics, in one word MILITARISMUS, had been Sparta's ruin. Her constitution bore too visibly the impress of conquest; her social system involved too surely the supremacy of a military caste; her domestic or national polity supplied no such experience and training as might have fitted her citizens for colonial expansion or imperial administration. The nicely balanced City-States of Greece exhausted each other in internecine wars till all alike fell an easy prey to the Makedonian. Yet the Makedonian, like the Roman conqueror after him, destroyed Hellas but was converted to Hellenism, and we must admit that the conquests of Alexander helped to spread Hellenic culture in the East, and that war in this instance was clearly a vehicle of progress. But the story of Hellenism in the West is quite different: here Greek culture won its way on its own merits and by purely pacific infiltration. The Roman was, indeed, in the eyes of the Greek, and even in his own eyes, a Barbarian: yet he had one political virtue, he knew not merely how to fight, but how to govern and to administer, so as to win from the defeated and the conquered first acquiescence, and then loyalty. What was the secret of this achievement? Why did Rome succeed where Sparta, and even Athens, had so egregiously failed? Rome succeeded because she invented, more by accident than by design, in short 'blundered into,' a potentially universal franchise, a citizenship applicable to an Empire, even an Empire virtually coterminous with the known world. This too was the charm which closed the temple of Janus, and gave the

*Pax Romana* for generations to civilized mankind. Permanent possibilities of warfare were indeed attested by the presence of four and twenty legions on the frontiers : but, until the irruptions of the barbarians, the foreign wars of Rome were comparatively insignificant, and fighting was mainly a means of settling mere questions of succession between rival pretenders backed by professional armies. Ancient History comes to a close with the collapse of the World-power, which for some five hundred years had reconciled East and West and pacified mankind from the wall of Hadrian to the cataracts of Nile, while recognising as coordinate expressions of its own will and wisdom the two languages, the two cultures, which to-day form the respective yet interdependent spheres of study for our British School at Athens and its sister—or might I not say, daughter—Institution in the eternal and amazingly modern city of the seven hills.

MR. R. M. DAWKINS gave an account, illustrated by lantern-slides, of his recent excavations at Pláti, in Crete.

A vote of thanks to DR. MACAN was carried by acclamation.

## THE BRITISH SCHOOL AT ATHENS.

1913-1914.

RECEIPTS AND EXPENDITURE ON ACCOUNT OF REVENUE AND  
EXCAVATIONS.

3RD OCTOBER, 1913, TO 2ND OCTOBER, 1914.

	£	s.	d.		£	s.	d.
Subscriptions received for the year	772	6	0	House Maintenance (as provided from London to June 30th, 1914)	54	17	2
Subscriptions received for past years	6	2	0	Hostel Maintenance (as provided from London <i>£ s. d.</i> to June 30th, 1914)	136	19	2
Government Grant	500	0	0	<i>Less Students' Fees</i>	57	18	3
Interest on Investment to July 5th, 1914	60	0	0		79	0	11
Interest on Deposit Account to June 30th, 1914	41	0	9	Salary, Director	500	0	0
Sale of Annuals, Vols. I.-XVII.	162	11	9	Salary, Assistant Director	150	0	0
Sale of Indices to the Annual	4	5	6	Publication of Annual (Vol. XIX.)	285	5	8
Special Donation for Excavations in Crete	30	0	0	Secretary, Salary to June 30th, 1914	40	0	0
				Rent to September 30th, 1914	10	0	0
				Printing, Postage, Stationery, &c.	28	6	9
				Studentship (Mr. Laistner)	100	0	0
				Grants (Miss Taylor <i>£50</i> , Miss Lamb <i>£10</i> )	60	0	0
				Excavations in Crete	200	4	10
				Excavations at Kamares Cave	6	0	4
				Balance, being excess of Receipts over Expenditure	62	10	4
					62	10	4
					£1,576	6	0
					£1,576	6	0

## RECEIPTS AND EXPENDITURE ON CAPITAL ACCOUNT.

3RD OCTOBER, 1913, TO 2ND OCTOBER, 1914.

	£	s.	d.		£	s.	d.
Donations as per list	15	0	0	Library	102	7	11
Balance, being excess of Expenditure over Receipts	87	7	11				
	£102	7	11		£102	7	11

## BALANCE ACCOUNT, 2ND OCTOBER, 1914.

		£ s. d.			£ s. d.
Subscriptions paid in advance . . . . .		4 3 0	Investment—India 3% Stock at par	2,000 0 0	
Anniversary Fund as per last Account	289 0 6		Cash at Bank :		
Mrs. Sach's Trust Fund £ s. d.			On Current Account	556 6 10	
(Income Account) as			On Deposit Account	1,000 0 0	
per last Account . . . . .	19 8 4			<u>1,556 6 10</u>	
Received during the year	18 16 1		Sundry Debtors . . . . .		7 2 6
	<u>38 4 5</u>				
Balance, representing the assets of the School other than land, build- ings, furniture, and library, as per last Account . . . . .	3,256 19 0				
Add Balance of Revenue for the year . . . . .	<u>62 10 4</u>				
	3,319 9 4				
Less Balance of Capital Account . . . . .	87 7 11				
	<u>3,232 1 5</u>				
	<u>£3,563 9 4</u>				<u>£3,563 9 4</u>

Examined and found correct,

EDWIN WATERHOUSE, F.C.A.

## DONATIONS—1913-1914.

## DONATIONS, 1913-1914.

	<i>£</i>	<i>s.</i>	<i>d.</i>
Zimmern, A. E. . . . .	10	0	0
Queen's College, Oxford . . . . .	5	0	0
	<hr/>		
	<u>£15 0 0</u>		

## SPECIAL DONATION FOR EXCAVATIONS IN CRETE.

Abercromby, Hon. J. . . . .	<u>£30</u>	0	0
-----------------------------	------------	---	---

## ANNUAL SUBSCRIPTIONS—1913-1914.

	£	s.	d.		£	s.	d.
The University of Oxford . . . . .	100	0	0				
The University of Cambridge . . . . .	100	0	0				
The Hellenic Society . . . . .	100	0	0				
The Society of Antiquaries . . . . .	5	5	0				
The Leeds Library . . . . .	1	0	0				
Brasenose College, Oxford . . . . .	5	0	0				
Caius College, Cambridge . . . . .	10	0	0				
Corpus Christi College, Oxford . . . . .	5	0	0				
King's College, Cambridge . . . . .	10	0	0				
Magdalen College, Oxford . . . . .	20	0	0				
McGill University . . . . .	5	5	0				
St. John's College Library . . . . .	1	0	0				
Sydney University . . . . .	1	0	0				
L'Association de Lectures Philologiques, Lausanne . . . . .	1	1	0				
University College, Reading . . . . .	1	0	0				
Victoria University of Manchester . . . . .	5	0	0				
* Westminster School Library . . . . .	1	1	0				
Museo di Gessi . . . . .	1	1	0				
Emmanuel College . . . . .	5	0	0				
					£377	13	0
	£	s.	d.		£	s.	d.
Brought forward	377	13	0	Brought forward	422	19	0
Abercromby, Hon. J. . . . .	2	2	0	Carrington, J. B. . . . .	1	1	0
Acland, Henry Dyke . . . . .	1	1	0	Caspari, M. . . . .	1	0	0
Adcock, F. E. . . . .	1	0	0	Caton, R. . . . .	1	1	0
Allbutt, Prof. Sir T. . . . .	1	1	0	Christie, Miss A. . . . .	1	1	0
Anderson, James . . . . .	1	1	0	Clark, C. R. . . . .	1	0	0
Anson, Sir W. R. . . . .	10	0	0	Clarke-Thornhill, T. B. . . . .	1	0	0
Ashby, Thomas . . . . .	1	1	0	Clausen, A. C. . . . .	1	1	0
Bailey, C. . . . .	1	1	0	Clissold, H. . . . .	1	0	0
Bailey, J. C. . . . .	5	0	0	Colchester, Lord . . . . .	5	0	0
Barlow, Sir T. . . . .	1	1	0	Cole, A. C. . . . .	2	2	0
Barrington, Mrs. Russell . . . . .	1	1	0	Compton, Rev. W. C. . . . .	1	1	0
Beazley, G. D. . . . .	1	1	0	Cooke, R. . . . .	1	1	0
Benecke, P. V. M. . . . .	2	2	0	Corbett, Sir V. . . . .	1	0	0
Bevan, E. R. . . . .	1	0	0	Crowfoot, J. W. . . . .	2	2	0
Blackburn, Mrs. . . . .	1	1	0	Cruddas, Miss . . . . .	2	2	0
Blomfield, R. . . . .	2	2	0	Davidson, H. O. D. . . . .	1	1	0
Bosanquet, Miss E. P. . . . .	1	1	0	Dickins, Mrs. A. L. . . . .	1	1	0
Bosanquet, Prof. R. C. . . . .	1	1	0	Donaldson, Rev. S. A. . . . .	1	1	0
Briggs, Miss E. M. . . . .	1	1	0	Droop, J. P. . . . .	1	1	0
Bristol, Bishop of . . . . .	1	1	0	Dundas, R. H. . . . .	1	0	0
Brooke, Rev. Stopford . . . . .	1	1	0	Elliot, Sir F. E. H. . . . .	1	0	0
Brooks, E. W. . . . .	1	0	0	Eumorfopoulos, G. . . . .	1	1	0
Burnett, J. J. . . . .	1	1	0	Eumorfopoulos, N. . . . .	2	0	0
Burrows, Dr. R. M. . . . .	1	1	0	Evans, A. J. . . . .	10	0	0
Bury, Prof. J. B. . . . .	1	1	0	Evans, F. Gwynne . . . . .	1	1	0
Buxton, A. F. . . . .	1	1	0	Farside, Mrs. . . . .	1	1	0
Carlisle, Miss . . . . .	1	1	0	Fell, S. P. . . . .	1	0	0
Carr, Rev. A. . . . .	1	1	0	Fletcher, H. M. . . . .	1	1	0
Carried forward	£422	19	0	Carried forward	£468	19	0

ANNUAL SUBSCRIPTIONS—1913-1914 (*continued*).

	£	s.	d.
Brought forward	468	19	0
Forster, E. C. . . . .	1	0	0
Fort, J. A. . . . .	1	0	0
Fotheringham, J. K. . . . .	1	0	0
Fowler, W. W. . . . .	1	1	0
Freshfield, D. W. . . . .	10	0	0
Fry, Sir E. . . . .	1	1	0
Furneaux, L. R. . . . .	1	0	0
Gardiner, E. Norman . . . . .	1	0	0
Gardner, Prof. E. A. . . . .	1	1	0
Gardner, Prof. Percy . . . . .	2	2	0
Goldsmith, Dr. . . . .	1	1	0
Gooch, G. P. . . . .	1	1	0
Goodwin, J. A. . . . .	1	1	0
Graham, E. . . . .	1	1	0
Griffith, F. Ll. . . . .	1	1	0
Haigh, P. B. . . . .	1	1	0
Hall, H. R. . . . .	1	1	0
Halliday, Miss C. H. . . . .	1	1	0
Halliday, W. R. . . . .	1	1	0
Handcock, W. . . . .	1	1	0
Hart, Mrs. P. . . . .	1	1	0
Hasluck, P. P. . . . .	1	1	0
Hawes, Miss . . . . .	1	1	0
Heberden, Rev. C. B. . . . .	2	2	0
Hett, W. S. . . . .	1	1	0
Hodgkin, J. E. . . . .	1	1	0
Hogarth, D. G. . . . .	1	1	0
Hooper, G. N. . . . .	1	1	0
Hopkinson, J. H. . . . .	1	1	0
Hutton, Miss C. A. . . . .	3	3	0
James, Rev. S. R. . . . .	2	0	0
Karo, Dr. C. . . . .	1	1	0
Kenyon, Sir F. G. . . . .	1	1	0
Keser, Dr. . . . .	1	1	0
Lascelles, B. P. . . . .	1	0	0
La Touch, C. D. . . . .	1	0	0
Lawrence, A. . . . .	1	1	0
Leaf, Herbert . . . . .	5	5	0
Leaf, Walter . . . . .	50	0	0
Leigh, E. C. A. . . . .	1	1	0
Lewis, Mrs. A. S. . . . .	2	2	0
Lindley, Miss J. . . . .	1	1	0
Lloyd, Miss . . . . .	1	1	0
Loewy, Prof. D. E. . . . .	1	1	0
Lorimer, Miss H. L. . . . .	1	0	0
Loring, W. . . . .	1	1	0
Lucas, Rev. A. . . . .	1	1	0
Lunn, W. H. . . . .	1	1	0
Lyttelton, Canon Hon. and Rev. E. . . . .	1	1	0
Macan, R. W. . . . .	1	1	0
McIver, D. R. . . . .	1	0	0

Carried forward £590 7 0

	£	s.	d.
Brought forward	590	7	0
MacLehose, James J. . . . .	1	1	0
Macmillan, G. A. . . . .	50	0	0
Macmillan, W. E. F. . . . .	1	1	0
Marindin, G. E. . . . .	1	1	0
Marshall, F. H. . . . .	1	1	0
Matthews, Mrs. . . . .	1	1	0
Mayor, R. J. G. . . . .	1	1	0
Miller, Rev. A. . . . .	1	1	0
Miller, W. . . . .	2	2	0
Milne, J. G. . . . .	1	1	0
Minturn, Miss E. T. . . . .	1	1	0
Mitchell, Mrs. E. H. . . . .	2	2	0
Moloney, W. A. . . . .	1	1	0
Moncrieff, Sir C. S. . . . .	1	1	0
Morrison, W. . . . .	10	0	0
Moss, Rev. Preb. H. W. . . . .	1	1	0
Myers, E. . . . .	1	1	0
Mylne, Mrs. . . . .	2	2	0
Newman, W. L. . . . .	2	2	0
Nightingale, Mrs. H. S. . . . .	1	1	0
Ogden, Mrs. P. . . . .	2	2	0
Palli, Mrs. F. L. . . . .	1	1	0
Pearse, Rev. T. N. Hart- Smith . . . . .	1	1	0
Pearson, Miss E. R. . . . .	1	0	0
Pease, Mrs. J. W. . . . .	5	5	0
Pennant, Hon. Alice D. . . . .	1	1	0
Penoyre, J. B. . . . .	1	0	0
Penrose, Miss . . . . .	1	1	0
Pesel, Miss Louisa F. . . . .	1	1	0
Petrocchino, D. P. . . . .	2	0	0
Phillimore, Prof. J. S. . . . .	1	1	0
Pickard-Cambridge, A. W. . . . .	1	0	0
Piddington, J. G. . . . .	2	2	0
Pilkington, A. C. . . . .	1	0	0
Pilkington, R. A. . . . .	1	0	0
Pollock, Sir F. . . . .	1	1	0
Poynter, Sir E. J. . . . .	5	0	0
Pryor, M. R. . . . .	1	0	0
Pyddoke, Miss M. . . . .	1	1	0
Radford, Miss E. . . . .	1	1	0
Reid, Dr. . . . .	1	1	0
Rendall, Dr. . . . .	1	1	0
Richards, H. P. . . . .	1	1	0
Ridgeway, Prof. W. . . . .	1	1	0
Roberts, Prof. W. Rhys . . . . .	1	1	0
Rodd, Sir R. . . . .	1	1	0
Rotton, Sir J. F. . . . .	2	2	0
Sandys, Sir J. E. . . . .	1	1	0
Seaman, Sir Owen . . . . .	1	1	0
Searle, G. von U. . . . .	1	1	0
Seeböhm, H. E. . . . .	1	1	0

Carried forward £717 19 0



ANNUAL SUBSCRIPTIONS—1913-1914 (*continued*).

	£	s.	d.		£	s.	d.
Brought forward	717	19	0	Brought forward	751	13	0
Shove, Miss E. . . . .	1	1	0	Weber, Sir H. . . . .	1	1	0
Sloane, Miss . . . . .	1	1	0	Webster, E. W. . . . .	1	0	0
Smith, A. H. . . . .	1	1	0	Weir, R. W. Schultz . . . . .	1	1	0
Strangeways, L. R. . . . .	1	0	0	Wells, J. . . . .	1	1	0
Tancock, Captain . . . . .	1	1	0	Welsh, Miss . . . . .	2	2	0
Thompson, F. E. . . . .	1	1	0	Whibley, Leonard . . . . .	1	0	0
Tod, J. N. . . . .	1	1	0	Wigram, Rev. W. A. . . . .	1	1	0
Tod, M. N. . . . .	1	1	0	Wilson, Major H. C. B. . . . .	1	1	0
Tod, Mrs. . . . . .	5	0	0	Wilson, R. D. . . . .	1	1	0
Tozer, Rev. H. F. . . . .	10	0	0	Withers, J. J. . . . .	1	1	0
Tuke, Miss . . . . .	1	1	0	Woodhouse, W. J. . . . .	1	1	0
Vaughan, E. L. . . . .	1	0	0	Woodward, A. M. . . . .	1	1	0
Verrall, Mrs. . . . . .	1	1	0	Wyndham, Hon. M. . . . .	1	1	0
Vince, J. H. . . . .	1	0	0	Wright, C. T. H. . . . .	1	1	0
Wace, Mrs. . . . . .	2	2	0	Yorke, V. W. . . . .	5	0	0
Wagner, H. . . . .	2	2	0				
Waldstein, Sir C. . . . .	1	1	0				
Ward, Dr. A. W. . . . .	1	0	0				
				Total . . . . .	£772	6	0

Carried forward £751 13 0

	£	s.	d.	£	s.	d.
Received during the year . . . . .				775	5	0
Paid in advance last year . . . . .				7	6	0
				<u>782</u>	<u>11</u>	<u>0</u>
Less Paid in advance at date . . . . .	4	3	0			
Paid on account of the years 1910-12						
as below . . . . .	2	0	0			
Paid on account of the years 1912-13 as						
below . . . . .	4	2	0			
				<u>10</u>	<u>5</u>	<u>0</u>
				<u>£772</u>	<u>6</u>	<u>0</u>

Received during the year subscription for 1910-11:—

Sydney University . . . . . £1 0 0

Received during the year subscription for 1911-12:—

Sydney University . . . . . £1 0 0

£2 0 0

Received during the year subscriptions for 1912-13:—

Sydney University . . . . . £1 0 0

University College, Reading . . . . . 1 0 0

Karo, Dr. G. . . . . 1 1 0

Verrall, Miss . . . . . 1 1 0

£4 2 0

ANNUAL SUBSCRIPTIONS—1913-1914 (*continued*).

Subscriptions received in advance:—	£	s.	d.
Burnett, J. J. . . . .	1	1	0
Caspari, M. . . . .	1	0	0
Haigh, P. B. . . . .	1	1	0
Seebohm, H. . . . .	1	1	0
	<hr/>		
	£4	3	0
	<hr/> <hr/>		

# LIST OF SUBSCRIBERS.

NOTE. Under No. V. of the Rules and Regulations, "the following shall be considered as Subscribers to the School:—

- (1) Donors, other than Corporate Bodies, of £10 and upwards.
- (2) Annual Subscribers of £1 and upwards during the period of their subscription."

In making out the following list, donations of less than £10 have been regarded as aggregate annual subscriptions of £1, and are spread over a corresponding number of years.

The Treasurer would be glad to be informed of any changes of address or errors in this list, which is made up to July 31st, 1915.

- HIS MAJESTY THE KING.  
 THE UNIVERSITY OF OXFORD.  
 \*THE UNIVERSITY OF CAMBRIDGE.  
 THE UNIVERSITY OF SHEFFIELD, EDGAR ALLEN LIBRARY.  
 THE MCGILL UNIVERSITY, Montreal.  
 THE SOCIETY FOR THE PROMOTION OF HELLENIC STUDIES, 19, Bloomsbury Square, W.C.  
 THE SOCIETY OF ANTIQUARIES, Burlington House, Piccadilly.  
 THE SOCIETY OF DILETTANTI (per E. H. Pember, Esq., K.C.).  
 BRASENOSE COLLEGE, Oxford.  
 CAIUS COLLEGE, Cambridge.  
 CHRIST CHURCH, Oxford.  
 CORPUS CHRISTI COLLEGE, Oxford.  
 CYPRUS MUSEUM, Nicoria, Cyprus.  
 EMMANUEL COLLEGE, Cambridge.  
 KING'S COLLEGE, Cambridge.  
 MAGDALEN COLLEGE, Oxford.  
 MANCHESTER. VICTORIA UNIVERSITY OF  
 MARBURG. LIBRARY OF THE ARCHAEOLOGICAL SEMINAR OF  
 MUSEO DI GESSI, R. Università di Roma, Rome.  
 NETTLESHIP LIBRARY, Clarendon Buildings, Oxford.  
 NEWNHAM COLLEGE, Cambridge.  
 L'ASSOCIATION DE LECTURES PHILOLOGIQUES, Valentin 44, Lausanne.  
 QUEEN'S COLLEGE, Oxford.  
 ST. JOHN'S COLLEGE, Cambridge.  
 THE FISHER LIBRARY, University of Sydney, N.S.W.  
 THE INSTITUTE OF ARCHAEOLOGY, 38-42, Bedford Street, Liverpool.  
 THE ROYAL INSTITUTE OF BRITISH ARCHITECTS, 9, Conduit Street, W.  
 THE GREEK PLAY COMMITTEE, Cambridge.  
 THE WORSHIPFUL COMPANY OF CLOTHWORKERS, Mincing Lane, E.C.  
 THE WORSHIPFUL COMPANY OF GOLDSMITHS, Goldsmiths' Hall, E.C.  
 THE LEEDS LIBRARY, Commercial Street, Leeds.  
 UNIVERSITY COLLEGE, Reading.  
 WESTMINSTER SCHOOL LIBRARY.
- |   |  |
|---|--|
| Abercromby, The Hon. John, 62, Palmerston Place, Edinburgh.<br>Acland, Henry Dyke, Esq., Chy an Mor, Gyllyngvase, Falmouth. | Agg-Gardner, J. T., Esq., Carlton Club, Pall Mall, S.W.<br>Alexander, W. C., Esq., 24, Lombard St., E.C. |
|---|--|

---

\* Address to C. E. Grant, Esq., King's College, Cambridge (Secretary to the Financial Board).

- Allbutt, Prof. Sir T. Clifford, K.C.B., F.R.S., M.D., St. Rhadegunds, Cambridge.
- Anderson, James, Esq., 19, Odos Loukianou, Athens.
- Ashby, Thos., Esq., British School at Rome, Palazzo Odescalchi, Rome.
- Austen-Leigh, E. C., Esq., Eton College.
- Bailey, Cyril, Esq., Balliol College, Oxford.
- Bailey, J. C., Esq., 34, Queen's Gate Gardens, S.W.
- Balfour, The Right Hon. G. W., Fisher's Hill, Woking.
- Barbour, Geo. F., Esq., Bonskeid, Pitlochry, N.B.
- Barbour, Mrs., Bonskeid, Pitlochry, N.B.
- Barlow, Sir T., Bart., M.D., 10, Wimpole St., W.
- Barrington, Mrs. Russell, 4, Melbury Road, W.
- Bather, Rev. A. G., Sunnyside, Winchester.
- Beaumont, H. D., Esq., British Legation, Athens.
- Beazley, J. D., Esq., Christ Church, Oxford.
- Benecke, P. V. M., Esq., Magdalen College, Oxford.
- Bernays, A. Evan, Esq., 3, Pitory Road, Kew.
- Bertram, Anton, Esq., Nicosia, Cyprus.
- Bevan, E. K., Esq., Sun House, 6, Chelsea Embankment, S.W.
- Blackburn, Mrs. V. P., Roshven, Lochailort, R.S.O., N.B.
- Blomfield, R., Esq., R.A., 51, Frognal, Hampstead, N.W.
- Bosanquet, Miss E. P., Heathercote, Ascot.
- Bosanquet, Prof. R. C., 40, Bedford Street N., Liverpool.
- Branch, C. C. Esq., 67, Chester Square, S.W.
- Brassey, The Right Hon. Lord, 24, Park Lane, W.
- Briggs, Miss M. G., Bear Hotel, Berne.
- Bristol, The Rt. Rev. the Bishop of, The Palace, Bristol.
- Brooke, The Rev. Stopford, The Four Winds, Ewhurst, Surrey.
- Brooks, E. W., Esq., 28, Great Ormond Street, W.C.
- Brown, James, Esq., Netherby, Galashiels.
- Brown, Adam, Esq., Netherby, Galashiels.
- Buckler, W. H., Esq., American Embassy, 18, Belgrave Square, S.W.
- Bulwer, Miss D. E., Coopers Cross, Uckfield, Sussex.
- Burnet, Prof. J., 19, Queen's Terrace, St. Andrews, N.B.
- Burrows, Dr. R. M., Principal's House, King's College, Strand, W.C.
- Bury, Prof. J. B., King's College, Cambridge.
- Buxton, A. F., Esq., Fairhill, Tonbridge.
- Carr, The Rev. A., Addington Vicarage, Croydon.
- Caspari, M. O. B., Esq., University College, Gower Street, W.C.
- Caton, R. Esq., M.D., Holly Lea, Livingstone Drive South, Liverpool.
- Chamberlain, The Right Hon. J. Austen, M.P., 9, Egerton Place, S.W.
- Chance, A. F., Esq., The Schools, Shrewsbury.
- Christie, Miss A., 12, Chester Street, Edinburgh.
- Clark, C. R. R., Esq., 12, Victoria Grove, Kensington, W.
- Clarke-Thornhill, T. B., Esq., 3, Carlisle Place, S.W.
- Clauson, A. C., Esq., Hawkshead House, Hatfield.
- Clissold, H., Esq., Clifton College, Bristol.
- Colchester, The Right Hon. Lord, St. Bruno, Sunningdale.
- Cole, A. C., Esq., 64, Portland Place, W.
- Colvin, Sir Sidney, 35, Palace Gardens Terrace, Kensington, W.
- Compton, The Rev. W. C., Sandhurst Rectory, Kent.
- Cooke, R., Esq., The Croft, Detling, Maidstone.
- Corbett, Sir Vincent, K.C.V.O.
- Cornford, F. M., Esq., Trinity College, Cambridge.
- Crewdson, Wilson, Esq., Southside, St. Leonards-on-Sea.
- Crowfoot, J. W., Esq., Khartum, Soudan.
- Daniel, A. M., Esq., 14, Royal Crescent, Scarborough.
- Daniel, Mrs., 14, Royal Crescent, Scarborough.
- Darbishire, R. S., Esq., Shelby City, Kentucky, U.S.A.
- Dawkins, R. M., Esq., Plas Dulas, Llanddulas, N. Wales.
- De Billy, Madame Edouard, 4, Rue de Talleyrand, Paris, (viième).
- Dickins, G. Esq., Apsley Croft, Oxford.
- Donaldson, The Rev. S. A., Master of Magdalene College, Cambridge.
- Douglas-Pennant, The Hon. Alice, Penrhyn Castle, Bangor, N. Wales.
- Droop, J. P., Esq., 11, Cleveland Gardens, Hyde Park, W.
- Dundas, R. H., Esq., Christ Church, Oxford.
- Durham, The Right Hon. the Earl of, 39, Grosvenor Square, W.
- Durnford, Walter, Esq., King's College, Cambridge.
- Egerton, Sir E. H., G.C.B., The Cliff, Torrington, Yorks.
- Elliot, Sir Francis E. H., K.C.M.G., British Legation, Athens.
- Empedocles, G., Esq., Commercial Bank of Greece, Athens.
- Cambridge, A. W. Pickard, Esq., Balliol College, Oxford.
- Carlisle, Miss Helen, Upper Brook House, Uttuxeter.
- Carr, Rear-Admiral, United Service Club, Pall Mall, S.W.

- Eumorfopoulos, G., Esq., Clandon Regis, Clandon West, nr. Guildford.
- Eumorfopoulos, N., Esq., 24, Pembridge Gardens, W.
- Evans, Sir Arthur J., LL.D., F.R.S., Youlbury, Berks, near Oxford.
- Evans, F. Gwynne, Esq., The Tower House, Woodchester, Stroud.
- Evans, Lady, c/o Union of London and Smith's Bank, Berkhamsted, Herts.
- Farside, Mrs., 39, Sloane Gardens, S.W.
- Fell, J. P. Esq., 21, Via Gaetano Filangieri, Naples, Italy.
- Finlay, Sir R. B., K.C., 31, Phillimore Gardens, W.
- Fletcher, H. M., Esq., 10, Lincoln's Inn Fields, W.C.
- Fletcher, John M., Esq., 9, Stanhope Street, Hyde Park, W.
- Forster, E. S., Esq., The University, Sheffield.
- Fort, J. A., Esq., 69, Kingsgate Street, Winchester.
- Fotheringham, J. K., Esq., 6, Blackhall Road, Oxford.
- Fowler, W. W., Esq., Lincoln College, Oxford.
- Fraser, J. H. P., Esq., M.D., Cumberland House, Southampton.
- Freshfield, D. W., Esq., Wych Cross Place, Forest Row, Sussex.
- Freshfield, Dr. Edwin, 31, O'd Jewry, E.C.
- Frisch, Eugene S., Esq., Elmsleigh, Prince's Park, Liverpool.
- Fry, The Right Hon. Sir Edward, F.R.S., Failand House, Failand, near Bristol.
- Furneaux, L. R., Esq., Rossall School, Fleetwood.
- Fyfe, Theo., Esq., 2, Montague Place, Russell Square, W.C.
- Gardner, Prof. Ernest, Litt.D., University College, Gower Street, W.C.
- Gardner, Prof. Percy, Litt.D., 11, Canterbury Road, Oxford.
- Gardiner, E. Norman, Esq., 2, The College, Epsom.
- Gennadius, H. E., Monsieur, The Greek Legation, 14, de Vere Gardens, W.
- Gibson, Mrs., LL.D., Castlebrae, Chesterton Road, Cambridge.
- Giveen, R. L., Esq., Colet Court, Hammer-smith Road, W.
- Gow, The Rev. James, Litt.D., 19, Dean's Yard, Westminster, S.W.
- Gooch, G. P., Esq., South Villa, Campden Hill Road, W.
- Goodwin, J. A., Esq., Shelley, Blundellsands, Lancs.
- Graham, E., Esq., Grove Hill, Harrow.
- Haigh, P. B., Esq., c/o Grindlay & Co., 54, Parliament Street, S.W.
- Hall, H. R., Esq., 22, King Henry's Road, N.W.
- Halliday, W. R., Esq., The University, Liverpool.
- Halliday, Miss, Glenthorne, Brendon, N. Devon.
- Handcock, W., Esq., Girdlington, Bradford, Yorks.
- Hart, Percival, Esq., Grove Lodge, Highgate, N.
- Harrison, Miss, LL.D., Newnham College, Cambridge.
- Hasluck, F. W., Esq., The Wilderness, Southgate, N.
- Hasluck, P. P., Esq., The Wilderness, Southgate, N.
- Hawes, Miss, 13, Sussex Gardens, W.
- Haworth, Jesse, Esq., Woodside, Bowdon.
- Heath, Mrs. M., Mortimer House, Clifton, Bristol.
- Heathcote, W. E., Esq., Chingford Lodge, New Walk Terrace, York.
- Heberden, C. B., Esq., Principal of Brasenose College, Oxford.
- Henderson, Sir A., Bart., M.P., 18, Arlington Street, W.
- Hett, Walter S., Esq., 11, College Terrace, Brighton.
- Hobhouse, Right Hon. H. H., Hadspen House, Castle Carey, Somerset.
- Hodgkin, T. Edward, Esq., Old Ridley, Stockfield, Northumberland.
- Hogarth, D. G., Esq., Ashmolean Museum, Oxford.
- Hooper, G. N. Esq., Elmleigh, Beckenham, Kent.
- Hopkinson, Rev. J. H., 18, Haversholt Road, Colne, Lancs.
- Hutton, Miss C. A., 49, Drayton Gardens, S.W.
- Impey, E., Esq., The Manor House, Steeple Ashton, Trowbridge.
- Iveagh, The Right Hon. Lord, 5, Grosvenor Place, S.W.
- James, The Rev. S. R., School House, Malvern.
- Jones, Ronald P., Esq., 208, Coleherne Court, S. Kensington, S.W.
- Jones, H. Stuart, Esq., Glan-y-Nor, Saundersfoot, Pembrokeshire.
- Karo, Dr. G., 1, Rue Pheidias, Athens.
- Kenyon, Sir Frederic, K.C.B., Litt.D., F.B.A., British Museum, W.C.
- Keser, J., Esq., M.D., Grande Boissière, 62, Route de Chêne, Geneva.
- King, Miss Catherine, Oxtou, Birkenhead.
- Lascelles, B. P., Esq., Headland, Mount Road, Harrow-on-the-Hill.
- Lawrence, Aubrey, Esq., 13, Norfolk Crescent, Hyde Park, W.
- Leaf, Herbert, Esq., The Green, Marlborough.

- Leaf, Mrs. Herbert, The Green, Marlborough.  
 Leaf, Walter, Esq., Litt.D., 6, St. James's Palace,  
 Regent's Park, N.W.  
 Lewis, Mrs. Agnes S., Ph.D., D.D., LL.D.,  
 Castle-brae, Chesterton Road, Cambridge.  
 Lindley, Miss Julia, 74, Shooter's Hill Road,  
 Blackheath, S.E.  
 Llangattock, The Right Hon. Lord, The Hendre,  
 Monmouth.  
 Lloyd, Miss A. M., Caythorpe Hall, Grantham.  
 Loewy, Prof. Dr. E., Via del Progresso, 23,  
 Rome.  
 Lorimer, Miss H. L., Somerville College, Oxford.  
 Loring, W., Esq., Allerton House, Grote's Build-  
 ings, Blackheath.  
 Lunn, W. Houldsworth, Esq., Allan Water  
 Hotel, Bridge of Allan, N.B.  
 Lyttelton, Hon. and Rev. Canon E., The  
 Cloisters, Eton College.
- Maberley, G. C., Esq., Wethersfield, Braintree,  
 Essex.  
 Macan, R. W., Esq., Master of University College,  
 Oxford.  
 McIver, D. R., Esq., 20, Fifth Avenue, New  
 York, U.S.A.  
 MacLehose, James J., Esq., 61, St. Vincent  
 Street, Glasgow.  
 Macmillan, G. A., Esq., D.Litt., St. Martin's  
 Street, W.C.  
 Macmillan, & Co., Ltd., Messrs., St. Martin's  
 Street, W.C.  
 Macmillan, W. E. F., Esq., 27, Queen's Gate  
 Gardens, S.W.  
 Marindin, G. E., Esq., Hammondswood, Frens-  
 ham, Farnham.  
 Marshall, F. H., Esq., 144, Abbey Road, West  
 Hampstead, N.W.  
 Matthews, Mrs., 15, Stanley Gardens, Bayswater,  
 W.  
 Mayor, R. J. G., Esq., Board of Education,  
 Whitehall, S.W.  
 Miller, The Rev. Alex., South United Free  
 Church Manse, Buckie, N.B.  
 Miller, W., Esq., 36, Via Palestro, Rome.  
 Milne, J. G., Esq., Bankside, Goldhill, Farnham,  
 Surrey.  
 Mitchell, Mrs., Jesmond Towers, Newcastle-on-  
 Tyne.  
 Moloney, W. A., Esq., Ginge Manor, Wantage,  
 Berks.  
 Monk, The Misses, 4, Cadogan Square, S.W.  
 Montefiore, C. G., Esq., 8, Palace Green, Ken-  
 sington, W.  
 Morrison, Walter, Esq., 77, Cromwell Road,  
 S.W.  
 Moss, Rev. Preb. H. W., Highfield Park, nr.  
 Oxford.  
 Murray, Messrs. J. & H., 50, Albemarle Street,  
 W.  
 Murray, Prof. G. G. A., 82, Woodstock Road,  
 Oxford.
- Murray, Hallam, Esq., The Home Farm, Sand-  
 ling, Hythe, Kent.  
 Myers, Ernest, Esq., Brackenside, Chislehurst,  
 Kent.  
 Mylne, Mrs., 145, Gloucester Terrace, Hyde  
 Park, W.  
 Myres, Prof. J. L., 101, Banbury Road, Oxford.
- Newman, W. L., Esq., Litt.D., D.Litt., 1, Pitt-  
 ville Lawn, Cheltenham.  
 Nightingale, Mrs. H. Shore-, 1, Devonshire  
 Place, W.
- Ogden, Mrs. P., Frogmal End, Hampstead,  
 N.W.  
 Oswald, J. W. Gordon, Esq. (of Aigas), Beauly,  
 Inverness-shire, N.B.
- Palli, Mrs. F. L., c/o London & Westminster  
 Bank, St. James's Square, S.W.  
 Paton, W. R., Esq., Vathy, Samos.  
 Pears, Sir E., 2, Rue de la Banque, Constanti-  
 nople.  
 Pearson, Miss E. R., M.A., Abbey Park South,  
 St. Andrews, N.B.  
 Pease, Wilson, Esq., 22, Mount Street, W.  
 Pease, Mrs. J. W., Pendower, Newcastle-on-  
 Tyne.  
 Penoyre, J. ff. B., Esq., 8, King's Bench Walk,  
 Inner Temple, E.C.  
 Penrose, Miss E., Somerville College, Oxford.  
 Pesel, Miss Louisa, Oak House, Bradford,  
 Yorks.  
 Petrocchino, D. P., Esq., 25, Rue de Timoleon,  
 Athens.  
 Phillimore, Prof. J. S., The University, Glasgow.  
 Phillips, Mrs. H., Sutton Oaks, Macclesfield,  
 Cheshire.  
 Piddington, J. G., Esq., Holy Well, Hook  
 Heath, Woking.  
 Pilkington, A. C., Esq., Rocklands, Rainhill,  
 Lancashire.  
 Pilkington, R. A., Esq., Ecclestone Grange,  
 Prescott, Lancs.  
 Pollock, The Right Hon. Sir F., Bart., 21, Hyde  
 Park Place, W.  
 Powell, Miss E., 9, Norfolk Street, Park Lane,  
 W.  
 Poynter, Sir E. J., Bart., P.R.A., 70, Addison  
 Road, W.  
 Pryor, Marlborough R., Esq., Weston Park,  
 Stevenage, Herts.  
 Pyddoke, Miss Mary, The Rectory, Barwick-in-  
 Elmet, Leeds.
- Rackham, H. Esq., Christ's College, Cambridge.  
 Radford, Miss E., 36, Moscow Court, Queen's  
 Road, W.  
 Ralli, Mrs. S., St. Catherine's Lodge, Hove,  
 Sussex.  
 Ralli, P., Esq., 17, Belgrave Square, S.W.

- Reid, Prof. J. S., Litt.D., Caius College, Cambridge.
- Rendall, The Rev. G. H., Litt.D., Dedham House, Dedham, Essex.
- Richards, H. P., Esq., Wadham College, Oxford.
- Ridgeway, Prof. W., Fen Ditton, Cambridge.
- Roberts, Prof. W. Rhys, The University, Leeds.
- Rodd, Sir Rennell, K.C.M.G., British Embassy, Rome.
- Rosebery, The Right Hon. the Earl of, K.G., The Durdans, Epsom.
- Rothschild, Messrs. N. M., and Sons, New Court, E.C.
- Rothschild, The Hon. Walter, 148, Piccadilly, W.
- Rotton, Sir J. F., Lockwood, Frith Hill, Godalming.
- Sandys, Sir John, Litt.D., St. John's House, Grange Road, Cambridge.
- Saumarez, The Right Hon. Lord de, Shrubland Park, Coddensham, Suffolk.
- Scott, C. P., Esq., The Firs, Fallowfield, Manchester.
- Scott-Moncrieff, Colonel Sir Colin, K.C.S.I., 11, Cheyne Walk, Chelsea, S.W.
- Scouloudi, Etienne, Esq., Athens, Greece.
- Seaman, Owen, Sir 2, Whitehall Court, S.W.
- Searle, G. von U., Esq., 30, Edith Road, West Kensington, W.
- Seebohm, Hugh, Esq., Poynder's End, Hitchin.
- Sharpe, Miss C., Stoneycroft, Elstree.
- Shove, Miss E., 30, York Street Chambers, Bryanston Square, W.
- Simpson, W. W., Esq., Winkley, Whalley.
- Sloane, Miss E. J., 13, Welford Road, Leicester.
- Smith, A. H., Esq., British Museum, W.C.
- Smith, Sir Cecil H., LL.D., 62, Rutland Gate, S.W.
- Smith-Pearse, Rev. T. N., The College, Epsom.
- Sullivan, John, Esq.,
- Tancock, Capt. A. D., 31st Punjabis, Parachinar, Kurram Valley, *via* Kohat, N.W.P. India.
- Thompson, Sir E. M., G.C.B., Mayfield, Sussex.
- Thompson, H. Y., Esq., 19, Portman Square, W.
- Tod, Mrs. Hedwig, 40, Inverleith Place, Edinburgh.
- Tod, J. N. Esq., Wolstenholme Hall, nr. Rochdale.
- Tod, M. N., Esq., Oriol College, Oxford.
- Townshend, Brian, Esq., 13, Plantation Avenue, Oxford.
- Tozer, The Rev. H. F., 18, Norham Gardens, Oxford.
- Tuke, Miss Margaret, Bedford Coll., Regent's Park, N.W.
- Vaughan, H., Esq.
- Vaughan, E. L., Esq., Eton College.
- Verrall, Mrs., 5, Selwyn Gardens, Cambridge.
- Vince, J. H. Esq., Bradfield College, Berkshire.
- Wace, Mrs., Leslie Lodge, Hall Place, St. Albans.
- Wagner, H., Esq., 13, Half Moon Street, W.
- Waldstein, Sir Charles, Litt.D., Newton Hall, nr. Cambridge.
- Wentworth, The Right Hon. Lord, 10, Great Stanhope Street, W.
- Wantage, The Lady, 2, Carlton Gardens, S.W.
- Ward, Sir A. W., Master of Peterhouse College, Cambridge.
- Waterhouse, Edwin, Esq., Feldemore, near Dorling.
- Weber, Sir H., M.D., 10, Grosvenor Street, W.
- Webster, E. W., Esq., Wadham College, Oxford.
- Weir, R. W. Schultz, Esq., 14, Gray's Inn Square, W.C.
- Wells, J., Esq., Wadham College, Oxford.
- Welsh, Miss Silvia M., Werneck-Strasse, 22 II, Munich, Bavaria.
- West, H. H., Esq., Oakwood Lodge, Chandler's Ford, Hants.
- Whibley, Leonard, Esq., Pembroke College, Cambridge.
- Wigram, Rev. W. A., Watling House, St. Albans.
- Williams, W. C. A., Esq., Garden House, Cornwall Gardens, S.W.
- Wilson, Major H. C. B., Crofton Hall, Crofton, Wakefield.
- Wilson, R. D., Esq., 38, Upper Brook Street, W.
- Wimborne, The Right Hon. Lord, 22, Arlington Street, S.W.
- Withers, J. J., Esq., Howard House, 4, Arundel Street, Strand, W.C.
- Woodhouse, Prof. W. J., The University, Sydney, N.S.W.
- Woodward, W. H., Esq., Crooksbury Hurst, Farnham.
- Woodward, A. M., Esq., The University, Leeds.
- Wright, Dr. Hagberg, London Library, St. James's Square, W.
- Wright, C. T. H., Esq.,
- Wyndham, Hon. Margaret, 12, Great Stanhope Street, W.
- Yorke, V. W., Esq., Farrington Works, Shoe Lane, E.C.
- Yule, Miss A., Tarradale House, Ross-shire.
- Zimmern, A. E., Esq., 14, Great Russell Mansions, Great Russell Street, W.C.

## DIRECTORS OF THE SCHOOL.

1886—1914.

F. C. PENROSE, M.A., D.C.L., LL.D., F.R.S., 1886—1887.

ERNEST A. GARDNER, M.A., 1887—1895.

CECIL H. SMITH, LL.D., 1895—1897.

DAVID G. HOGARTH, M.A., 1897—1900.

R. CARR BOSANQUET, M.A., 1900—1906.

R. McG. DAWKINS, M.A., 1906—1914.

A. J. B. WACE, M.A., 1914—

## HONORARY STUDENTS OF THE SCHOOL.

1886—1914.

- Prof. J. B. Bury, LL.D., Litt.D., D.Litt. King's College, Cambridge. Elected 1895.
- Sir Arthur J. Evans, LL.D., D.Litt., F.R.S. Late Keeper of the Ashmolean Museum, Oxford. Elected 1895.
- Prof. J. Linton Myres, M.A. A former Student of the School. Elected 1896.
- Prof. Ernest Gardner, M.A. Formerly Director of the School. Elected 1897.
- \*Prof. A. van Millingen, M.A., D.D. Professor of History at Robert College, Constantinople. Elected 1904.
- \*W. H. Forbes, M.A. Late Fellow of Balliol College, Oxford. Elected 1906.
- Prof. W. J. Woodhouse. Professor in the University of Sydney. Formerly Student of the School. Elected 1908.
- A. J. B. Wace, M.A. Director of the School. Late Lecturer in Ancient History and Archaeology at the University of St. Andrews. Elected 1912.
- J. D. Beazley, M.A. Student of Christ Church. Elected 1914.
- E. N. Gardiner, M.A. Corpus Christi College, Oxford. Elected 1914.
- R. McG. Dawkins, M.A. Fellow of Emmanuel College, Cambridge. Formerly Director of the School. Elected 1914.

---

\* Deceased.



# STUDENTS OF THE SCHOOL.<sup>1</sup>

1886—1914.

- Ernest A. Gardner. M.A., Litt. D. Formerly Fellow of Gonville and Caius College, Cambridge and Craven University Student. Yates Professor of Archaeology in the University of London. Admitted 1886—87. Director of the School, 1887—1895. Hon. Student of the School.
- David G. Hogarth. M.A. Fellow and formerly Tutor of Magdalen College, Oxford, and first Craven Fellow. Keeper of the Ashmolean Museum. Director of the School 1897—1900. Admitted 1886—87. Re-admitted (for work in Cyprus) 1887—88.
- Rupert C. Clarke. M.A. Exeter College, Oxford. Rector of Ellesborough, Bucks and Rural Dean of Wendover. Admitted 1886—87.
- F. H. H. Guillemard. M.A., M.D., F.L.S., etc. Gonville and Caius College, Cambridge. First University Reader in Geography. Admitted (for work in Cyprus) 1887—88.
- Montague R. James. Litt.D. Provost and late Tutor of King's College, Cambridge. Director of the Fitzwilliam Museum. Admitted (for work in Cyprus) 1887—88, with grant of £100 from the University.
- R. Elsey Smith. F.R.I.B.A. Professor of Architecture and Construction, King's College, London. Appointed to Studentship by Royal Institute of British Architects, 1887—88.
- R. W. Schultz Weir. Admitted as Gold Medallist and Travelling Student in Architecture of the Royal Academy of Arts, 1887—88. Re-admitted 1888—89, 1889—90.
- Sidney H. Barnsley. Admitted as Student of the Royal Academy, 1887—88. Re-admitted 1889—90, 1890—91.
- J. A. R. Munro. M.A. Fellow and Lecturer of Lincoln College, Oxford. Admitted (for work in Cyprus) 1888—89. Re-admitted (for same purpose) 1889—90.
- H. Arnold Tubbs. M.A. Pembroke College, Oxford. Craven University Fellow. Professor of Classics at University College, Auckland, N.Z. Admitted (for work in Cyprus) 1888—89. Re-admitted (for same purpose) 1889—90.
- J. G. Frazer. M.A. Fellow of Trinity College, Cambridge. Admitted 1889—90, with grant of £100 from the University of Cambridge to collect material for commentary on Pausanias.<sup>2</sup>
- William Loring. M.A. Warden of Goldsmiths' College, New Cross. Late Fellow of King's College, Cambridge. Secretary of the School, 1897—1903. Appointed to Cambridge Studentship, 1889—90. Re-admitted as Craven University Student, 1890—91, 1891—92, and 1892—93.

<sup>1</sup> \* Before a name signifies "deceased."

<sup>2</sup> This grant was afterwards returned to the University.

- W. J. Woodhouse. M.A. Queen's College, Oxford. Professor of Greek in the University of Sydney, N.S.W. Formerly Lecturer in Ancient History and Political Philosophy at the University of St. Andrews. Appointed to Oxford Studentship, 1889—90. Re-admitted as Craven University Fellow, 1891—92 and 1892—93.
- G. C. Richards. M.A. Late Fellow of Hertford College. Fellow and Tutor of Oriel College, Oxford. Formerly Professor of Greek at University College, Cardiff. Admitted as Craven University Fellow, 1889—90. Re-admitted 1890—91.
- O. H. Parry. M.A. Magdalen College, Oxford. Vicar of All Hallows, East India Dock. Formerly Archbishop's Missioner to the Nestorian Christians. Admitted 1889—90.
- J. F. R. Stainer. M.A., B.C.L. Magdalen College, Oxford. Admitted 1889—90.
- R. A. H. Bickford-Smith. M.A., F.S.A. Trinity College, Cambridge. Admitted 1889—90.
- A. G. Bather. M.A. Late Fellow of King's College, Cambridge. Assistant Master at Winchester College. Admitted 1889—90. Re-admitted 1891—92, on appointment to the Cambridge Studentship; 1892—93 as Prendergast Greek Student; and again, 1893—94, as Cambridge Student.
- E. E. Sikes. M.A. Fellow and Tutor of St. John's College, Cambridge. Appointed to Cambridge Studentship, 1890—91.
- J. G. Milne. M.A. Corpus Christi College, Oxford. Examiner in the Board of Education. Appointed to Oxford Studentship, 1890—91.
- H. Stuart Jones. M.A. Fellow and formerly Tutor of Trinity College, Oxford. Formerly Director of the British School at Rome. Admitted as Craven University Fellow, 1890—91. Re-admitted 1892—93.
- Miss Eugénie Sellers (Mrs. S. Arthur Strong). Girton College, Cambridge. Assistant Director of the British School at Rome. Formerly Keeper of the Duke of Devonshire's Collections. Admitted 1890—91.
- F. Brayne Baker. M.A. Sometime Scholar of Christ's College, Cambridge. Assistant Master at Malvern College. Admitted 1891—92.
- C. C. Inge. M.A. Magdalen College, Oxford. Vicar of Holmwood, Surrey. Appointed 1891—92 to the Oxford Studentship.
- E. F. Benson, M.A. King's College, Cambridge. Admitted 1891—92, with grant of £100 from the Worts Fund at Cambridge; 1892—93 on appointment to the Cambridge Studentship; 1893—94 as Craven Student; and 1894—95 as Prendergast Student.
- J. G. Piddington. B.A. (J. G. Smith) Magdalen College, Oxford. Admitted 1891—92. Re-admitted 1895—96.
- V. W. Yorke. M.A. Late Fellow of King's College, Cambridge. Admitted 1892—93. Re-admitted 1893—94.
- J. L. Myres. M.A. Wykeham Professor of Ancient History in the University of Oxford. Formerly Fellow of Magdalen College, Oxford. Student and Tutor of Christ Church. University Lecturer in Classical Archaeology. Gladstone Professor of Greek in the University of Liverpool. Admitted 1892—93 as Craven Fellow. Re-admitted 1893—94 and 1894—95. Hon. Student of the School.

- R. J. G. Mayor. M.A. Late Fellow of King's College, Cambridge. Assistant Secretary in the Board of Education. Admitted 1892-93.
- R. C. Bosanquet. M.A. Trinity College, Cambridge. Professor of Archaeology in the University of Liverpool. Assistant Director of the School, 1899-1900. Director 1900-1906. Admitted 1892-93. Re-admitted as Craven University Student 1894-95. Re-admitted as Craven Student 1895-96 and 1896-97.
- J. M. Cheetham, M.A. Christ Church, Oxford. Admitted on appointment to the Oxford Studentship. 1892-93.
- E. R. Bevan. M.A. New College, Oxford. Admitted 1893-94.
- A. F. Findlay. M.A. Sent out as holder of Browne-Downie Fellowship by the United Presbyterian Church, Divinity Hall, Edinburgh. Admitted 1894-95.
- J. G. Duncan. M.A., B.D. Sent out from Aberdeen by the Church of Scotland. Admitted 1894-95.
- J. E. Brooks. M.A. St. Peter's College, Cambridge. Admitted 1894-95. Re-admitted as Associate 1896-97.
- \*H. Awdry. M.A. New College, Oxford. Assistant Master at Wellington College. Admitted 1894-95.
- Duncan Mackenzie. M.A. (Edin.), Ph.D. (Vienna) Universities of Edinburgh and Vienna. Carnegie Fellow in History at the University of Edinburgh. Admitted 1895-6. Re-admitted 1896-97, 1897-98 and 1898-99.
- Archibald Paterson. University of Edinburgh. Admitted 1895-96.
- C. R. Rowland Clark. Student of the Royal Academy. Appointed 1895-96, and re-appointed 1896-97, by the Managing Committee to an Architectural Studentship.
- C. C. Edgar. B.A. Oriel College, Oxford. Inspector of Antiquities for Lower Egypt. Admitted 1895-96, and re-admitted 1896-97 (as Craven University Fellow), 1897-98 and 1898-99.
- F. R. Earp. M.A. Late Fellow of King's College, Cambridge. Admitted 1896-97.
- \*F. A. C. Morrison. M.A. Jesus College, Cambridge. Admitted (as Prendergast Greek Student) 1896-97.
- H. H. West. M.A. Formerly of Trinity College, Cambridge. Admitted 1896-97.
- Miss C. A. Hutton. Girton College, Cambridge. Admitted 1896-97.
- Pieter Rodeck. Architect, Cairo. Admitted 1896-97 as Travelling Student and Gold Medallist of the Royal Academy.
- J. G. C. Anderson. M.A. Formerly Fellow of Lincoln College. Student, Tutor, and sometime Senior Censor of Christ Church, Oxford. Admitted (as Craven University Fellow) 1896-97.
- J. W. Crowfoot. M.A. Brasenose College, Oxford. Inspector in the Ministry of Education, Cairo. Formerly Assistant Director of Education and Acting Curator of Antiquities, Sudan Government. Lecturer in Classics, Mason College and University, Birmingham. Admitted, on appointment to the Oxford Studentship, 1896-97. Re-admitted 1897-98.
- W. W. Reid. Universities of Aberdeen and Edinburgh. Admitted, as holder of Blackie Travelling Scholarship, 1896-97.

## LIST OF STUDENTS.

163

- A. E. Henderson. F.S.A. Owen Jones Student of Royal Institute of British Architects, R.B.A. 1897—98. Admitted 1897—98. Re-admitted 1898—99, 1901—02, and 1902—03.
- W. A. Curtis. Heriot Scholar of Edinburgh University. Admitted 1897—98.
- A. J. Spilsbury. M.A. Queen's College, Oxford. Senior Classical Master, City of London School. Admitted 1897—98, on appointment to the Oxford Studentship.
- E. B. Hoare. Magdalen College, Oxford. Admitted 1897—98, as Architectural Student.
- J. C. Lawson. M.A. Fellow and Lecturer of Pembroke College, Cambridge. Admitted as Craven University Student, 1898—99. Re-admitted 1899—1900.
- C. D. Edmonds. M.A. Emmanuel College, Cambridge. Assistant Master at Royal Naval College, Osborne. Formerly at Aldenham School. Admitted as Prendergast Student, 1898—99.
- J. H. Marshall. C.I.E., M.A., F.S.A. Scholar of King's College, Cambridge. Director-General of the Archaeological Survey of India. Admitted 1898—99. Re-admitted as Prendergast Student, 1900—01, Craven Student, 1901—2.
- \*Clement Gutch. M.A. King's College, Cambridge. Lecturer at St. John's College, Cambridge. Admitted, 1898—99, on appointment to the Cambridge Studentship.
- F. B. Welch. M.A. Magdalen College, Oxford. Second Master at Pocklington School. Admitted as Craven University Fellow, 1898—99. Re-admitted 1899—1900.
- T. D. Atkinson. F.R.I.B.A. Surveyor to the Dean and Chapter of Ely. Admitted as Architectural Student, 1898—99.
- J. K. Fotheringham. M.A., D.Litt. Merton and Magdalen Colleges, Oxford. Fellow of Magdalen College, Oxford. Lecturer in Ancient History at King's College, London. Examiner in the University of London; Brassey Research Student. Admitted on appointment to Oxford Studentship, 1898—99.
- J. H. Hopkinson. M.A. University College, Oxford. Warden of Hulme Hall and Lecturer in Classical Archaeology, University of Manchester. Formerly Lecturer in Greek, University of Birmingham. Admitted as Craven University Fellow, 1899—1900 and 1900—01.
- S. C. Kaines-Smith. Magdalene College, Cambridge. Admitted 1899—1900, on appointment to Cambridge Studentship.
- Miss O. C. Köhler (Mrs. Charles Smith). Girton College, Cambridge. Admitted 1899—1900.
- D. Theodore Fyfe. F.R.I.B.A. Architectural Association Travelling Student, 1899. Admitted 1899—1900, on appointment to Architectural Studentship.
- †K. T. Frost. M.A., F.R.G.S. Brasenose College, Oxford. Lecturer at the Queen's University, Belfast. Admitted on appointment to the Oxford Studentship, 1900—01.
- R. D. Wells. M.A., A.R.I.B.A. Trinity College, Cambridge. Admitted on appointment to the Architectural Studentship, 1900—01.

† Killed in action, September, 1914.

- J. ff. Baker-Penoyre. M.A. Keble College, Oxford. Secretary and Librarian to the Society for Promoting Hellenic Studies. Secretary to the British School at Athens. Admitted 1900-01. Re-admitted 1906-7, 1907-8.
- Marcus N. Tod. M.A. Fellow of Oriel College, Oxford, and University Lecturer in Greek Epigraphy. Craven University Fellow. Assistant-Director of the School 1902-1904. Admitted on appointment to "Senior Studentship," 1901-02.
- F. W. Hasluck. M.A. Sometime Fellow of King's College, Cambridge. Assistant Director of the School from 1906. Admitted on appointment to Cambridge Studentship, 1901-02. Re-admitted 1902-03, 1904-05, 1905-06, 1906-07, 1907-8, 1908-9, 1909-10, 1910-11.
- C. Heaton Conyn. Admitted on appointment to the Architectural Studentship, A.R.I.B.A., M.R.San.I. 1901-02. Re-admitted 1903-04.
- Miss H. L. Lorimer. Girton College, Cambridge. Classical Tutor of Somerville College, Oxford. Admitted as Pfeiffer Travelling Student, 1901-02.
- Baroness E. Rosenörn-Lehn. Royal Holloway College, and University College, London. Admitted 1901-02.
- A. P. Oppé. B.A. New College, Oxford. Victoria and Albert Museum. Formerly Examiner in the Board of Education. Lecturer in Greek at St. Andrews University, and Lecturer in Ancient History at Edinburgh University. Admitted 1901-02.
- W. L. H. Duckworth. Fellow of Jesus College, Cambridge. University Lecturer in M.D., Sc.D., M.A. Physical Anthropology. Admitted 1902-03.
- C. T. Currelly. M.A., F.R.G.S. Victoria College, Toronto. Director of the Royal Museum, Ontario. Formerly Assistant to Professor Flinders Petrie, under the Egypt Exploration Fund. Admitted 1902-03. Re-admitted 1903-04.
- R. McG. Dawkins. M.A. Fellow of Emmanuel College, Cambridge. Director of the School from 1906-14. Admitted 1902-03. Re-admitted as Craven Student, 1903-04. Re-admitted 1904-05.
- E. S. Forster. M.A., F.S.A. Bishop Frazer's Scholar, Oriel College, Oxford. Lecturer in Greek in the University of Sheffield. Formerly Assistant Lecturer in the University College of N. Wales. Admitted on appointment to the Oxford Studentship, 1902-03. Re-admitted 1903-04, with grants from the Craven Fund and Oriel College.
- A. J. B. Wace. M.A. Fellow of Pembroke College, Cambridge. Director of the School. Lecturer in Ancient History and Archaeology at University of St. Andrews. Prendergast Student. Craven Student. Assistant Director of the British School at Rome, 1905. Admitted 1902-03. Re-admitted 1903-04, 1904-05, 1905-06, 1906-07, 1907-08, 1908-09, 1909-10, 1910-11.
- E. W. Webster. M.A. Fellow of Wadham College, Oxford. Taylorian Scholar in German, 1901. John Locke Scholar in Mental Philosophy, 1904. Admitted 1902-03.
- J. F. Fulton. Soane Student. Admitted 1902-03.
- E. F. Reynolds. Admitted 1902-03.
- M. O. B. Caspari. B.A. Late Scholar of Corpus Christi College, Oxford. University Scholar in German. Reader in Ancient History in the University of London. Admitted 1903-04.

- J. L. Stokes. B.A. Scholar of Pembroke College, Cambridge. Librarian of Charterhouse School. Admitted (as Holder of the Prior Scholarship from Pembroke College), 1903-04.
- Miss M. K. Welsh (Mrs. A. M. Daniel). Newnham College, Cambridge. Holder of the Marion Kennedy Studentship. Admitted 1903-04.
- G. Dickins. M.A. Fellow of St. John's College, Oxford. Craven Fellow. Admitted 1904-05. Re-admitted as School Student, 1905-06, 1906-07, 1907-08, 1908-09. Re-admitted 1912-13.
- C. C. T. Doll. M.A. Trinity College, Cambridge. Superintending Architect at the excavations at Knossos since 1905. Admitted 1904-05.
- C. H. Hawes. M.A. Trinity College, Cambridge. Professor of Anthropology Dartmouth College, U.S.A. Admitted 1904-05.
- W. A. Kirkwood. M.A. University College, Toronto. Admitted 1904-05.
- H. J. W. Tillyard. M.A. Caius College, Cambridge. Lecturer in Greek, University of Edinburgh. Admitted 1904-05 as Assistant Librarian. Re-admitted 1905-06 (on appointment to Studentship), 1906-07, 1908-09. Re-admitted 1912-13.
- Miss G. M. A. Richter. M.A. Girton College, Cambridge. Assistant Curator in Department of Classical Antiquities, Metropolitan Museum of Art, New York. Admitted 1904-05.
- J. P. Droop. B.A. Trinity College, Cambridge. Late Assistant to Dr. Stein in the arrangement of his collections. Admitted 1905-06. Prendergast Student 1906-07, 1907-08, 1908-09, 1910-11. Re-admitted 1912-13, 1913-14.
- Miss M. Hamilton. M.A. University of St. Andrews. Holder of a Research Fellowship under the Carnegie Trust. Admitted 1905-06, 1906-07.
- A. C. B. Brown. B.A. D.Litt. (Mrs. G. Dickins). Scholar of New College, Oxford. Fereday Fellow of St. John's College, Oxford. Formerly Assistant Lecturer in Classics, Manchester University. Assistant Master at Marlborough College. Admitted 1905-06.
- F. Orr. Admitted 1905-06.
- R. Traquair. A.R.I.B.A. Admitted 1905-06 (on appointment to an Architectural Studentship). Professor of Architecture, McGill University, Montreal. Student of the Byzantine Fund.
- Miss E. B. Abrahams. M.A. University College, London. Admitted 1905-06.
- J. Farrell. M.A. Fellow of Jesus College, Cambridge. Admitted 1906-07, 1907-08, 1908-09.
- Walter S. George. Travelling Student in Architecture of the Royal College of Art. Soane Medallist of Royal Institute of British Architects. Admitted 1906-07. Re-admitted 1908-9, 1909-10, as Student of the Byzantine Research Fund. Re-admitted 1912-13.
- T. E. Peet. B.A. Queen's College, Oxford. Officer of Egypt Explor. Fund. Admitted as Craven Fellow 1906-07, 1908-09.
- A. M. Woodward. M.A. Late Classical Demy of Magdalen College, Oxford. Assistant Lecturer in Classics and Ancient History at the University of Leeds. Assistant Director, 1909-10. Admitted 1906-7, 1907-08, 1908-09.
- W. M. Calder. B.A. Christ Church, Oxford. Professor of Greek in Victoria University, Manchester. Formerly Wilson Travelling Fellow, Aberdeen University. Research Student, Brasenose College, Oxford. Admitted 1907-08.

- W. Harvey. Gold Medallist and Travelling Student of the Royal Academy. Admitted 1907-08.
- H. Pirie-Gordon. M.A. Magdalen College, Oxford. Admitted 1907-08.
- M. S. Thompson. B.A. Corpus Christi College, Oxford. Holder of Chas. Oldham University Scholarship. Admitted 1907-08, 1908-09, 1909-10, 1910-11.
- A. C. Sheepshanks. B.A. Trinity College, Cambridge. Assistant Master at Eton. Admitted 1907-08.
- N. Whatley. M.A. Fellow of Hertford College, Oxford. Admitted 1907-08.
- †G. L. Cheesman. M.A. Fellow and Lecturer of New College, Oxford. Admitted 1908-09.
- A. W. Gomme. B.A. Trinity College, Cambridge. Assistant Lecturer in Greek, University of Glasgow. Formerly Assistant Lecturer in Classics, Liverpool University. Prendergast Student. Admitted 1908-09.
- L. B. Budden. B.A. Travelling Student in Architecture of the University of Liverpool. Admitted 1909-10.
- S. W. Grose. B.A. Scholar of Christ's College, Cambridge. School Student. Admitted 1909-10.
- H. A. Ormerod. B.A. Queen's College, Oxford. Assistant Lecturer in Greek, University of Liverpool. Admitted 1909-10, 1910-11.
- H. H. Jewell. Royal Academy Gold Medallist. Admitted 1909-10.
- W. R. Halliday. B.A., B.Litt. New College, Oxford. Rathbone Professor of Ancient History in the University of Liverpool. Craven Fellow. Admitted 1910-11. Re-admitted 1912-13.
- Miss D. Lamb. Newnham College, Cambridge. Admitted 1910-11; 1913-14.
- Miss L. E. Tennant. (Mrs. F. J. Watson Taylor.) Admitted 1910-11.
- E. S. G. Robinson. B.A. Christ's College, Oxford. Assistant in the Coin and Medal Dept., British Museum. School Student. Admitted 1910-11.
- L. B. Tillard. B.A. St. John's College, Cambridge. Admitted 1910-11.
- A. J. Toynbee. M.A. Fellow of Balliol College, Oxford. Admitted 1911-12.
- B. V. Darbshire. B.A. Balliol College, Oxford. Admitted 1911-12.
- Miss M. M. Hardie. (Mrs. F. W. Hasluck.) Newnham College, Cambridge. Admitted 1911-12.
- E. M. W. Tillyard. B.A. Jesus College, Cambridge. Admitted 1911-12.
- W. M. Laistner. B.A. Jesus College, Cambridge. Craven Student. Admitted 1912-13. Re-admitted 1913-14 as School Student.
- S. Casson. B.A. St. John's College, Oxford. School Student. Admitted 1912-13. Re-admitted 1913-14.
- R. S. Lambert. Repton School.
- Gordon Leith. Holder of Herbert Baker Studentship. Admitted 1912-13.
- C. A. Scutt. B.A. Prendergast Student of the University of Cambridge. Admitted 1912-13. Re-admitted 1913-14.
- Miss M. N. L. Taylor. Newnham College, Cambridge. Admitted 1913-14.
- J. Arnott Hamilton. M.A. University of Edinburgh. Holder of the Blackie Scholarship. Admitted 1913-14.
- Miss E. Radford. Admitted 1913-14.
- Miss Agnes Conway. Admitted 1913-14.
- Rev. W. A. Wigram. D.D. Admitted 1913-14.

† Killed in action, August, 1914.

## ASSOCIATES OF THE SCHOOL.

Rev. A. H. Cruikshank.	Elected	1896.
Ambrose Poynter, Esq.	"	1896.
J. E. Brooks, Esq.	"	1896.
Miss Louisa Pesel.	"	1902.
J. F. Crace, Esq.	"	1902.
Miss Mona Wilson.	"	1903.
J. S. Carter, Esq.	"	1903.
B. Townsend, Esq.	"	1903.
A. M. Daniel, Esq.	"	1903.
H. W. Allen, Esq.	"	1906.
W. Miller, Esq.	"	1906.
George Kennedy, Esq.	"	1906.
A. E. Zimmern, Esq.	"	1910.
Miss Negrepointe.	"	1912.
C. J. Ellingham, Esq.	"	1913.
Capt. H. M. Greaves, R.A.	"	1913.



## SUGGESTED PLAN OF STUDY.

Under an ideal system a student would spend two or three seasons in Greece, devoting *the first year to general studies, the second to some special subject.*

During the first year the student, while not losing sight of his special subject, might apportion his time thus:—

*August and September.*—Learn German in Berlin, Munich, or Dresden, and thus be able to profit by the three or four courses of lectures given by the Secretaries of the German and Austrian Institutes in Athens. For archaeological literature some knowledge of German is practically essential.

*October.*—Arrive in Greece. Acquire if possible some use of Modern Greek. See Olympia, Delphi, Mycenae, Epidaurus, the Argive Heraion, before the November rains.

*November (middle).*—Remain three or four months in Athens steadily working at sites and in Museums, attending courses of lectures and making frequent short excursions to points of interest by train, cycle, etc.

*March and April.*—Travel, study sites, join one of the Island cruises for students.

*May and June.*—Begin to concentrate on special work, *e.g.* assist in excavations, with a view to working upon the results during the coming year and excavating with more or less complete control in the second summer,

*or* explore a given district in Greece or Asia Minor, an island or a group of islands,

*or* work in museums in Italy, Austria, or Germany,

*or* attend lectures in Pompeii and spend some months in Rome and the cooler Etruscan cities. In this case the student is advised to attach himself to the British School at Rome (Palazzo Odescalchi), in order that he may be admitted to the Library, and have the right to attend the lectures (see rules of the School).

*The second year* should be devoted almost entirely to special work in a narrower field.

The course here suggested must be modified to suit each case. There will always be students who are already specialists in some branch of classical learning and only seek fresh material for research. There will be others who wish to see something of all sides of ancient life in order to illuminate their reading and fit themselves for general classical teaching, although they have not time for minute archaeological study.

RULES AND REGULATIONS  
OF THE  
BRITISH SCHOOL AT ATHENS.

---

OBJECTS OF THE SCHOOL.

I. The first aim of the School shall be to promote the study of Greek archaeology in all its departments. Among these shall be (i) the study of Greek art and architecture in their remains of every period ; (ii) the study of inscriptions ; (iii) the exploration of ancient sites ; (iv) the tracing of ancient roads and routes of traffic.

II. Besides being a School of Archaeology, it shall be also, in the most comprehensive sense, a School of Classical Studies. Every period of the Greek language and literature, from the earliest age to the present day, shall be considered as coming within the province of the School.

III. The School shall also be a centre at which information can be obtained and books consulted by British travellers in Greece.

IV. For these purposes a Library shall be formed, and maintained, of archaeological and other suitable books, including maps, plans, and photographs.

THE SUBSCRIBERS.

V. The following shall be considered as Subscribers to the School :—

(1) Donors, other than Corporate Bodies, of £10 and upwards.

(2) Annual Subscribers of £1 and upwards during the period of their subscription.

VI. A corporate body subscribing not less than £50 a year, for a term of years, shall, during that term, have the right to nominate a member of the Managing Committee.

VII. A meeting of Subscribers shall be held in October of each year, at which each Subscriber shall have one vote. A subscribing corporate body may send a representative. At this meeting a report from the Managing Committee shall be presented, including a financial statement and selections from the reports of the Director and Students for the season. At this meeting shall also be annually elected or re-elected the Treasurer and the Secretary of the School, two Auditors, and four members of the Managing Committee, in place of those retiring under Rule XIII. (3).

VIII. Special meetings of Subscribers may, if necessary, be summoned by the Managing Committee.

IX. Subscribers shall be entitled to receive a copy of any reports that may be published by the School, to use the Library, and to attend the public meetings of the School, whenever they may be in Athens.

THE TRUSTEES.

X. The property of the School shall be vested in three Trustees, who shall be appointed for life, except as hereinafter provided. Vacancies in the number of Trustees shall be filled up at the annual meeting of the Subscribers.

XI. In the event of a Trustee becoming unfit or incapable of acting, he may be removed from his office by a majority of three-fourths of those present at a special meeting of Subscribers summoned by the Managing Committee for that purpose, and another Trustee shall by the same majority be appointed in his place.

XII. In the event of the death or resignation of a Trustee occurring between two annual meetings, the Managing Committee shall have the power of nominating another Trustee to act in his place until the next annual meeting.

THE MANAGING COMMITTEE.

XIII. The Managing Committee shall consist of the following :—

(1) The Trustees of the School.

(2) The Treasurer and Secretary of the School.

(3) Twelve Members elected by the Subscribers at the annual meetings. Of these, four shall retire in each year, at first by lot, afterwards by rotation. Members retiring are eligible for re-election.

(4) The members nominated by corporate bodies under Rule VI.

XIV. The Committee shall have control of all the affairs of the School, and shall decide any dispute that may arise between the Director and Students. They shall have power to deprive any Student of the use of the school-building.

XV. The Committee shall meet as a rule once in every two months ; but the Secretary may, with the approval of the Chairman and Treasurer, summon a special meeting when necessary.

XVI. Due notice of every meeting shall be sent to each member of the Committee by a summons signed by the Secretary. Three members of the Committee shall be a quorum.

XVII. In case of an equality of votes, the Chairman shall have a second or casting vote.

XVIII. In the event of vacancies occurring among the officers or on the Committee between the annual elections, they may be provisionally filled up by the Committee until the next annual meeting.

#### HONORARY STUDENTS, STUDENTS, AND ASSOCIATES

XIX. The Students shall consist of the following :—

- (1) Holders of travelling fellowships, studentships, or scholarships at any University of the United Kingdom or of the British Colonies.
- (2) Travelling Students sent out by the Royal Academy, the Royal Institute of British Architects, the Byzantine Research and Publication Fund, or other similar bodies.
- (3) Other persons who shall satisfy the Managing Committee that they are duly qualified to be admitted to the privileges of the School.

XX. No person, other than a student of the British School at Rome, shall be admitted as a Student who does not intend to reside at least three months in Greek lands. In the case of Students of the British School at Rome, an aggregate residence of four months at the two Schools will be accepted as alternative to three months' residence in Greece.

XXI. Students attached to the School will be expected to pursue some definite course of study or research in a department of Hellenic studies, and to write in each season a report upon their work. Such reports shall be submitted to the Director, shall by him be forwarded to the Managing Committee, and may be published by the Committee if and as they think proper.

XXII. Intending Students are required to apply to the Secretary. They will be regarded as Students from the date of their admission by the Committee to the 31st day of October next following; but any Student admitted between July 1st and October 31st in any year shall continue to be regarded as a Student until October 31st of the following year.

XXIII. The Managing Committee may elect as Honorary Students of the School such persons as they may from time to time deem worthy of that distinction, and may also elect as Associates of the School any persons actively engaged in study or exploration in Greek lands.

XXIV. Honorary Students, Students, and Associates shall have a right to use the Library of the School and to attend all lectures given in connexion with the School, free of charge.

XXV. Students shall be expected to reside in the Hostel provided for them, except with the sanction of the Managing Committee. Priority of claim to accommodation in the Hostel shall be determined by the Committee.

#### THE DIRECTOR.

XXVI. The Director shall be appointed by the Managing Committee, on terms which shall be agreed upon at the time, for a period of not more than three years. He shall be eligible for re-election.

XXVII. He shall have possession of the school-building as a dwelling-house.

XXVIII. It shall be his duty (1) to guide and assist the studies of Students and Associates of the School, affording them all the aid in his power, and also to see that reports are duly furnished by Students, in accordance with Rule XXI., and placed in the hands of the Secretary before the end of June; (2) to assist in editing the School Annual.

XXIX. (a) Public Meetings of the School shall be held in Athens during the season, at which the Director and Students of the School shall read papers on some subject of study or research, and make reports on the work undertaken by the School. (b) The Director shall deliver lectures to Students of the School. At least six of such meetings and lectures shall be held in the course of each session.

XXX. He may at his discretion allow persons, not Students of the School, to use the Library and attend his lectures.

XXXI. He shall be resident at Athens from the beginning of November in each year to the end of the following June, but shall be at liberty to absent himself for short periods for purposes of exploration or research.

XXXII. At the end of each season he shall report to the Managing Committee—(i) on the studies pursued during the season by himself and by each Student; (ii) on the state of the School-premises and the repairs needed for them; (iii) on the state of the Library and the purchases of books, &c. which he may think desirable; and (iv) on any other matter affecting the interests of the School.

XXXIII. In case of misconduct the Director may be removed from his office by the Managing Committee by a majority of three-fourths of those present at a meeting specially summoned for the purpose. Of such meeting at least a fortnight's notice shall be given.

RULES FOR THE MACMILLAN HOSTEL.

XXXIV. The management of the Hostel shall be at the discretion of the Director and shall be subject to his control.

XXXV. The Director shall have power to exclude a Student from the Hostel in case of misconduct ; but such exclusion must be immediately reported to the Managing Committee

XXXVI. The Students shall, until further notice, pay a fixed charge of twelve shillings a week for the smaller, and fourteen shillings a week for the larger rooms in the Hostel. These payments shall include fire, lighting, and the necessary servants' wages.

XXXVII. Honorary Students, Associates, members of the Committee, and ex-directors may be admitted to residence in the Hostel. Other persons, if seriously engaged in study or research, may be admitted by the Director at his discretion. But no person shall reside in the Hostel under this rule to the exclusion of any Student desiring admission.

XXXVIII. The weekly charge for residents other than Students shall be seventeen shillings and sixpence until further notice.

XXXIX. The Director shall draw up further rules for the internal management of the Hostel ; such rules to be subject to the approval of the Managing Committee.

RULES FOR THE LIBRARY.

XL. The Director shall have power to make rules for the management of the Library, its use by Students, and the like ; such rules to be subject to the approval of the Managing Committee.

PUBLICATION.

XLI. No publication whatever, respecting the work of the School, shall be made without the previous approval of the Committee.

THE FINANCES.

XLII. All money received on behalf of the School beyond what is required for current expenses shall be invested in the names and at the discretion of the Trustees.

XLIII. The banking account of the School shall be placed in the names of the Treasurer and Secretary, who shall sign cheques jointly.

XLIV. The first claim on the revenue of the School shall be the maintenance and repair of the School-building, and the payment of rates, taxes, and insurance.

XLV. The second claim shall be the salaries of the Director and Secretary, as arranged between them and the Managing Committee.

XLVI. In case of there being a surplus, a sum shall be annually devoted to the maintenance of the Library of the School and to the publication of a report ; and a fund shall be formed from which grants may be made for travelling and excavation.

*Revised, 1913.*

MANAGING COMMITTEE, 1914—1915.

- |  |                                 |
|--|---------------------------------|
| EDWIN FRESHFIELD, Esq., LL.D.  | } Trustees.                     |
| WALTER LEAF, Esq., Litt.D.   |                                 |
| GEORGE A. MACMILLAN, Esq., D.Litt., <i>Chairman.</i>                               |                                 |
| PROFESSOR PERCY GARDNER, Litt.D. Appointed by the University of Oxford.            | } Appointed by the Subscribers. |
| SIR JOHN SANDYS, Litt.D. Appointed by the University of Cambridge.                 |                                 |
| MISS JANE E. HARRISON, D.Litt., LL.D. Appointed by the Hellenic Society.           |                                 |
| MISS C. A. HUTTON, <i>ex-officio</i> as joint editor of the <i>Annual.</i>         |                                 |
| PROFESSOR R. C. BOSANQUET, M.A.  |                                 |
| R. M. DAWKINS, Esq., M.A.  |                                 |
| SIR ARTHUR J. EVANS, D.Litt., LL.D.  |                                 |
| PROFESSOR ERNEST GARDNER, M.A.   |                                 |
| WALTER S. GEORGE, Esq.   |                                 |
| D. G. HOGARTH, Esq., M.A.  |                                 |
| PROFESSOR J. LYNTON MYRES, M.A.  | } Appointed by the Subscribers. |
| SIR CECIL HARCOURT-SMITH, LL.D.  |                                 |
| M. N. TOD, Esq., M.A.  |                                 |
| SIR CHARLES WALDSTEIN, Litt.D.   |                                 |
| L. WHIBLEY, Esq., M.A.   |                                 |
| A. E. ZIMMERN, Esq., M.A.  |                                 |
| V. W. YORKE, Esq., M.A., <i>Hon. Treasurer</i> , Farrington Works, Shoe Lane, E.C. |                                 |
| JOHN H. BAKER-PENOYRE, Esq., M.A., <i>Secretary</i> , 19, Bloomsbury Square, W.C.  |                                 |

DIRECTOR, 1914—1915.

A. J. B. WACE, Esq., M.A., Fellow of Pembroke College, Cambridge.  
*Assistant Director and Librarian* :—F. W. HASLUCK, Esq., M.A., Late Fellow of King's College, Cambridge.

## NOTICE TO CONTRIBUTORS.

CONTRIBUTORS to the *Annual of the British School at Athens* are requested to use the following systems of transliteration when writing in English such Greek words as have not become part of the English language :—

### ANCIENT GREEK.

#### *Vowels.*

$a = a :$  }  
 $\left\{ \begin{array}{l} \epsilon = e : \\ \eta = e : \end{array} \right.$  } krater, lekane.

$\iota = i :$  kalpis.

$\left\{ \begin{array}{l} o = o : \\ \omega = o : \end{array} \right.$  kothon, kantharos, Amyklaion.

$u = y$  after a consonant, as aryballos, kylix ;  $u$  after another vowel, as boule.

$ai = ai :$  Aigion, Erythrai, except at the end of words, such as Mycenae, which are commonly Latinised in form, when *ae* may be used.

$ei = ei :$  Meidias.

$oi = oi :$  Chalkioikos.

$ui = ui :$  muia.

$av = au :$  Aulis.

$ev = eu :$  Eutychos.

$ov = ou :$  boule.

#### *Consonants.*

$\beta = b ; \gamma = g ; \delta = d ; \zeta = z ; \theta = th ; \kappa = k^1 ; \lambda = l ; \mu = m ; \nu = n ; \xi = x ;$   
 $\pi = p ; \rho = r ; \sigma, \varsigma = s ; \tau = t ; \phi = ph ; \chi = ch ; \psi = ps ; \gamma\gamma = ng ; \gamma\kappa = nk ;$   
 $\gamma\chi = nch ; \rho' = rh.$

<sup>1</sup>  $\kappa$  never = *c* except for place-names like Corinth, Mycenae, or some names of persons like Cleon, which have become English words.

*Accents.*

Contributors are requested to indicate accents and breathings very clearly and accurately.

MODERN GREEK.<sup>1</sup>*Vowels.*

- $\left. \begin{array}{l} a = \alpha : \\ \epsilon = \epsilon : \\ \eta = \epsilon : \\ \iota = \iota : \end{array} \right\} \text{Πέντε Πηγάδια} = \text{Pénte Pegádia.}$
- $\left\{ \begin{array}{l} \overset{o}{\omega} = o : \end{array} \right\} \text{Γεώργιος} = \text{Geórgios.}$
- $v = \gamma :$  Μολάοι = Moláoi. But for *av*, *ev*, *ou* see below.
- $ai = \alpha\iota :$  Καισαριανή = Kaisariané.
- $ei = \epsilon\iota :$  Ἁγία Εἰρήνη = Hagía Eiréne.
- $oi = \omicron\iota :$  Μύλοι = Mýloi.
- $ui = \upsilon\iota :$  ψυχουῖός = psychouíós.
- $ou = \omicron\upsilon :$  Σκριποῦ = Skripouí.
- $\left\{ \begin{array}{l} av \\ ev \end{array} \right\} = af \text{ and } ef \text{ before unvoiced consonants } (\theta, \kappa (\xi, \psi), \pi, \varsigma, \tau, \phi, \chi) \text{ and}$   
 $av, ev \text{ before vowels and voiced consonants: Εὐθύμιος} =$   
 Eftthýmios; Λάβρα = Lávra.

*Consonants.*

$\beta = v ; \gamma = g,$  but  $\gamma\gamma, \gamma\kappa$  and  $\gamma\chi$  as *ng, nk* and *nch*;  $\delta = d ; \zeta = z ; \theta = th ;$   
 $\kappa = k ; \lambda = l ; \mu = m ; \nu = n ; \xi = x ; \pi = p ; \rho = r ; \rho\rho = rrh ; \acute{\rho} = rh ; \sigma, \varsigma = s ;$   
 $\tau = t ; \phi, \chi, \psi = ph, ch, ps.$

The rough breathing to be written h : Ἁγιος Γεώργιος = H. Geórgios.

*Accents.*

Accents, in all cases to be written as acute, to be indicated.

In any case where the Greek form of the word is felt to be obscured it may be added in Greek letters (in brackets) the first time a word occurs, and conversely the exact pronunciation, if it should be of importance for any reason, may be specially indicated.

<sup>1</sup> The arguments in support of this system will be found in Mr. R. M. Dawkins' paper on 'The Transliteration of Modern Greek' in *B.S.A.* vol. xv.

## ABBREVIATIONS, ETC.

For the conventions respecting the indication of quotations from ancient and modern authorities, titles of periodical and collective publications, transliteration of inscriptions, and quotations from MSS. and literary texts, contributors are referred to the accompanying notes drawn up by the Editors of the *Journal of Hellenic Studies*, and kindly placed by them at the disposal of contributors to the *Annual*.

---

[REPRINTED FROM *The Journal of Hellenic Studies*, VOL. XXIX., PART II., 1909, PP. LXXXVII—IX.]

*Quotations from Ancient and Modern Authorities.*

Names of authors should not be underlined; titles of books, articles, periodicals, or other collective publications should be underlined (for italics). If the title of an article is quoted as well as the publication in which it is contained, the latter should be bracketed. Thus:

Six, *Jahrb.* xviii. 1903, p. 34,

or—

Six, *Protogenes* (*Jahrb.* xviii. 1903), p. 34.

But as a rule the shorter form of citation is to be preferred.

The number of the edition, when necessary, should be indicated by a small figure above the line; e.g. Dittenb. *Syll.*<sup>2</sup> 123.

*Titles of Periodical and Collective Publications.*

The following abbreviations are suggested, as already in more or less general use. In other cases, no abbreviation which is not readily identified should be employed.

*A.-E.M.* = Archäologisch-epigraphische Mitteilungen.

*Ann. d. I.* = Annali dell' Istituto.

*Arch. Anz.* = Archäologischer Anzeiger (Beiblatt zum Jahrbuch).

*Arch. Zeit.* = Archäologische Zeitung.

*Ath. Mitt.* = Mitteilungen des Deutschen Arch. Inst., Athenische Abteilung.

Baumeister = Baumeister, Denkmäler des klassischen Altertums.

*B.C.H.* = Bulletin de Correspondance Hellénique.

- Berl. Vas.* = Furtwängler, Beschreibung der Vasensammlung zu Berlin.  
*B.M. Bronzes* = British Museum Catalogue of Bronzes.  
*B.M. Coins* = British Museum Catalogue of Greek Coins.  
*B.M. Rings* = British Museum Catalogue of Finger-Rings.  
*B.M. Inscr.* = Greek Inscriptions in the British Museum.  
*B.M. Jewellery* = British Museum Catalogue of Jewellery.  
*B.M. Sculpt.* = British Museum Catalogue of Sculpture.  
*B.M. Terracottas* = British Museum Catalogue of Terracottas.  
*B.M. Vases.* = British Museum Catalogue of Vases, 1893, etc.  
*B.S.A.* = Annual of the British School at Athens.  
*B.S.R.* = Papers of the British School at Rome.  
*Bull. d. I.* = *Bullettino dell' Istituto*.  
 Busolt = Busolt, Griechische Geschichte.  
*C.I.G.* = *Corpus Inscriptionum Graecarum*.  
*C.I.L.* = *Corpus Inscriptionum Latinarum*.  
*Cl. Rev.* = *Classical Review*.  
*C.R. Acad. Inscr.* = *Comptes rendus de l'Académie des Inscriptions*.  
*C.R. St. Pétr.* = *Compte rendu de la Commission de St. Pétersbourg*.  
 Dar.-Sagl. = Daremberg-Saglio, *Dictionnaire des Antiquités*.  
 Dittenb. *O.G.I.* = Dittenberger, *Orientalis Graeci Inscriptiones Selectae*.  
 Dittenb. *Syll.* = Dittenberger, *Sylloge Inscriptionum Graecarum*.  
 Εφ. Ἀρχ. = *Ἐφημερίς Ἀρχαιολογική*.  
*G.D.I.* = Collitz, Sammlung der Griechischen Dialekt-Inschriften (or Collitz-Bechtel).  
 Gerh. *A.V.* = Gerhard, *Auserlesene Vasenbilder*.  
*G.G.A.* = Göttingensche Gelehrte Anzeigen.  
 Head, *H.N.*<sup>2</sup> = Head, *Historia Numorum*. Revised Edition, 1910.  
*I.G.* = *Inscriptiones Graecae*.<sup>1</sup>  
*I.G.A.* = Röhl, *Inscriptiones Graecae antiquissimae*.  
*Jahrb.* = *Jahrbuch des Deutschen Archäologischen Instituts*.  
*Jahresh.* = *Jahreshefte des Oesterreichischen Archäologischen Instituts*.  
*J.H.S.* = *Journal of Hellenic Studies*.  
*Klio* = *Klio* (Beiträge zur alten Geschichte).  
 Le Bas-Wadd. = Le Bas-Waddington, *Voyage Archéologique*.  
*Liverpool Annals* = *Annals of Archaeology and Anthropology of University of Liverpool*.  
 Michel = Michel, *Recueil d'Inscriptions grecques*.  
*Mon. d. I.* = *Monumenti dell' Istituto*.  
 Müller-Wies. = Müller-Wieseler, *Denkmäler der alten Kunst*.  
*Mus. Marbles.* = *Collection of Ancient Marbles in the British Museum*.

<sup>1</sup> The attention of contributors is called to the fact that the titles of the volumes of the second issue of the *Corpus of Greek Inscriptions*, published by the Prussian Academy, have now been changed, as follows:—

<i>I.G.</i>	I.	=	Inscr. Atticae anno Euclidis vetustiores.
	II.	=	„ „ aetatis quae est inter Eucl. ann. et Augusti tempora.
	III.	=	„ „ aetatis Romanae.
	IV.	=	„ Argolidis.
	VII.	=	„ Megaridis et Boeotiae.
	IX.	=	„ Graeciae Septentrionalis.
	XII.	=	„ Insul. Maris Aegaei praeter Delum.
	XIV.	=	„ Italiae et Siciliae.



*Neue Jahrb. kl. Alt.* = Neue Jahrbücher für das klassische Altertum.

*Neue Jahrb. Phil.* = Neue Jahrbücher für Philologie.

Niese = Niese, Geschichte der griechischen u. makedonischen Staaten.

*Num. Chr.* = Numismatic Chronicle.

*Num. Zeit.* = Numismatische Zeitschrift.

Pauly-Wissowa = Pauly-Wissowa, Real-Encyclopädie der classischen Altertumswissenschaft.

*Philol.* = Philologus.

Ramsay, *C.B.* = Ramsay, Cities and Bishoprics of Phrygia.

Ramsay, *Hist. Geog.* = Ramsay, Historical Geography of Asia Minor.

Reinach, *Rép. Sculpt.* = S. Reinach, Répertoire des Sculptures.

Reinach, *Rép. Vases* = S. Reinach, Répertoire des Vases peints

*Rev. Arch.* = Revue Archéologique.

*Rev. Ét. Gr.* = Revue des Études Grecques.

*Rev. Num.* = Revue Numismatique.

*Rev. Philol.* = Revue de Philologie.

*Rh. Mus.* = Rheinisches Museum.

*Röm. Mitt.* = Mitteilungen des Deutschen Archäologischen Instituts, Römische Abteilung.

Roscher = Roscher, Lexicon der Mythologie.

*S.M.C.* = Sparta Museum Catalogue.

*T.A.M.* = Tituli Asiae Minoris.

*Zf.N.* = Zeitschrift für Numismatik.

### *Transliteration of Inscriptions.*

[ ] Square brackets to indicate additions, *i.e.* a lacuna filled by conjecture.

( ) Curved brackets to indicate alterations, *i.e.* (1) the resolution of an abbreviation or symbol; (2) letters misrepresented by the engraver; (3) letters wrongly omitted by the engraver; (4) mistakes of the copyist.

< > Angular brackets to indicate omissions, *i.e.* to enclose superfluous letters appearing on the original.

. . . Dots to represent an unfilled lacuna when the exact number of missing letters is known.

- - - Dashes for the same purpose, when the number of missing letters is not known.

Uncertain letters should have dots under them.

Where the original has iota adscript, it should be reproduced in that form; otherwise it should be supplied as subscript.

The aspirate, if it appears on the original, should be represented by a special sign, <sup>h</sup>.

*Quotations from MSS. and Literary Texts.*

The same conventions should be employed for this purpose as for inscriptions, with the following *important exceptions*.

- ( ) Curved brackets to indicate only the resolution of an abbreviation or symbol.
- [[ ]] Double square brackets to enclose superfluous letters appearing in the original.
- <> Angular brackets to enclose letters supplying an omission in the original.

## British School at Athens.

---

THIS School (founded in 1886) gives to British Students of Greek Archaeology and Art the opportunity of pursuing their researches in Greece itself, with command of the means which the recent great advances of the science have rendered indispensable.

Athens is now an archaeological centre of the first rank. The architecture of Greece can nowhere else be studied to such advantage; and the concentration in the Athenian museums, of treasures of Antiquity found in Greek soil during the last few decades of years, has made a personal knowledge of those museums in the highest degree desirable for Hellenic scholars.

The student requires two auxiliaries when working in Athens. First, the command of an adequate library; and second, the advice of trained archaeologists residing on the spot, who follow the rapid advance of the science due to new discovery and the rearrangement of old materials.

These advantages are now provided for French, German, Austrian, American, and British archaeologists. By means of these Schools many excavations on Greek soil have been carried out; and those conducted in Cyprus, in the Peloponnese, in Melos, in Crete, and, finally, in Sparta and Northern Greece by the British School during the past twenty-five Sessions are an encouraging proof of the work that may be done in the future if the School be adequately supported. The *Annual of the British School at Athens*, an archaeological periodical of recognisedly high standing, affords an opportunity for the publication of the Students' more important results.

Students are admitted free of charge. They are required to pursue some definite course of Hellenic study or research, residing for the purpose not less than three months in Greek lands,<sup>1</sup> and at the end of the Session to write a report of the work they have done. Applications from intending students should be made to the Secretary, JOHN ff. B. PENNYRE, Esq., 19, Bloomsbury Square, W.C., who will also give full information.

Donations or annual subscriptions to the School are much needed, and will be gladly received. They should be sent to the Hon. Treasurer, V. W. YORKE, Esq., M.A., Farringdon Works, Shoe Lane, E.C.

<sup>1</sup> In the case of Students of the British School at Rome, an aggregate residence of four months at the two Schools will be accepted as alternative to three months' residence at the School at Athens.

## INDEX.

- ACHMET of Yassi, 120; identified by Bektashi sect with Hadji Bektash, 120, 121
- Ali Pashi of Yannina, political connection of, with Bektashi Order of Dervishes, 113; toleration towards Christians, 115; influence of, outside his own district, 116 f.
- Anthemous, reputed site of, 131
- Aqueducts, Roman at Smyrna, 92 f.
- Aristolochia microstoma, 5 note 1
- Athens, mediaeval descriptions of, 64 f.; views of, 65; Thevet's account of, 64, 65
- BASIL plant, importance of, in modern Greek superstitions, 33
- Beehive tomb, at Pláti, in Crete, 13 ff.; date of, 15; mainland influence shown in, *ibid.*
- Bektashi, best known as order of Dervishes, 95; lay members of sect of, 95, 96; political importance of, 97, 113 ff.; connection of, with Janissaries, 97, 99, 118; suppressed by Mahmoud II. in 1826, 97, 118; favoured by Abdul Medjid, 97 note 2; present political importance of, in Albania, 97; connection of, with Ali Pasha of Yannina, 113 ff., 116; in Asia Minor, 97; in Roumeli, 116 f. Extensive political and religious propaganda by, 94, 96, 113. Doctrines of, 95 f., 97; points of contact with *Shia* Mahomedanism, 95, 96; with Christianity, 100, *ibid.* note 3; wide toleration of other sects, 95 f. Original name of sect, Houroufi, 96; adopted name of Bektashi from Anatolian saint, Hadji Bektash, *ibid.*; etymology of name, 105 note 8. Encroachments of, on convents and saints of other Moslem sects, 97, 99; on Christian sanctuaries, 102 ff., 106, 108 ff., 112, 116; methods employed, 94, 101, 112; aims of, 113
- Bronze: ingot, with figure of dancer in relief from Pláti, 2; tool, 130
- Burial cist in beehive tomb of L.M. III. period at Pláti, 15; in beehive tombs on mainland, 15 and *ibid.* note 2
- Busioc (basil-plant), 33
- CAROLS, Gypsy, 33, 57, 58; modern Greek, 32 ff. See also under S. Basil. From Phárasa in the Anti-Taurus, 43 note 2; Roumanian, 33
- Celts, 130; bored, *ibid.*
- Charms, narrative, 42
- Clay, larnax from Pláti, 14
- Coidasa, Turkish legendary heroine, 89
- Colinde*, 33
- Colour adjectives, use of, to distinguish tribes, 107 note 1
- Crocodiles' heads as talismans, 75
- DEDE, Turkish saint's tomb, 98; Yousouf Dede at Smyrna, 85
- De Chin, Sire Gilles, exploits of, 73, 79
- De Gozon, Dieudonné, 70 ff.; historical facts concerning, 70, 72, 74, 78; legends of adventures in Rhodes, 70, 71, 72; points of interest in, 72, 73; possible explanation of, 77 ff., 79. Pierre Melac, 79
- Dervishes, orders of: Bairami, 99 note 4; Bektashi, 95 ff.; Kadri, 99, *ibid.* note 3; Mevlevi, 101, 119; Nakshbendi, 99, *ibid.* note 3
- Dialect, Cappadocian, of Místi, 43; Tsakonian, 18 ff.
- Door pivots, holes for, in L.M. III. houses at Pláti, 11



- Dragons, mediaeval stories of fights with, 70, 71, *ibid.* note 4, 73, 76, *ibid.* note 4; folk-lore connection of, with water, 77. Crocodiles, 76; head of, as talisman over gates, 75; dummy, 77  
 "Dragon-stones," 75, *ibid.* note 4, 79
- ENTRANCE-PASSAGE, in L.M. III. house at Pláti, construction of, 30; paralleled in modern Turkish houses in Crete, *ibid.*  
 Evliya Effendi, 121, 122  
 Exhedra, tomb, with Greek inscription, 89 note 13; of Herodes, at Olympia, 93
- FADLULLAH, Persian mystic, founder of Houroufi sect, 96; connection of, with Christians, *ibid.*; suffered martyrdom at hands of Timour II., *ibid.*  
 Flint, knives, 130  
 Folk-tales in Tsakonian dialect, 18 ff.  
 Frescoes, 15th century in Rhodes, 74, 75, 79; Christian, in Turkish tomb at Adalia, 104
- GATES, city, protected by talismans, 75, 76, *ibid.* note 3  
 'Geometric' pottery from Thessalian sites, 130, 132  
*Grande Insulaire*, by André Thevet, 19 ff.  
 Granite seat with inscription, 89 note 13  
 Gypsy carols, 33, 57, 58
- HADJI BEKTASH, Anatolian saint, 96; 'adopted' founder of Bektashi sect. *ibid.*; Bektashi traditions concerning, 121 ff.  
 Haidar, eponymous saint of Haidar-es-Sultan, 98, 120; identified by Bektashi with Khodja Achmet of Yassi, 98, 120; *tekkes* of, 98, 103  
 Hearth, central, in L.M. III. building at Pláti, 7 f.  
 Houroufi, Persian sect founded in 14th century, 96; persecuted by Timour, *ibid.*; affiliated to and absorbed *tekke* of Hadji Bektash  
 Houses; L.M. III. at Pláti, ground plans of
- INSCRIPTIONS; French, on tomb of Dieudonné de Gozon, 74. Greek: published by André Thevet, 64, 66; 89 note 12, 92, 128, 131, 132. Latin: 65; 72, 76 (mediaeval). Thracian, 126
- JANISSARIES, connection of Bektashi sect with, 97; destroyed by Sultan Mahmoud II., *ibid.*  
 Janus, Temple of, at Smyrna, 88, 89  
 Jews, in Aegean islands in 17th century, 61 f.; influential position of, at Constantinople, 62; story of, at Anaphi, 61 note 5  
 'Judicatorium' at Smyrna, 89, 90, 92
- KALANTÁ, 32  
 Karadja Achmet, prince of Persia, 98, 120 f.; sepulchre of, a place of healing, 121; claimed by Bektashi as 'founder's kin,' *ibid.*; *tekkes* of: near Akhissar, *ibid.*; at Scutari (Constantinople) *ibid.*; near Uskub, 111, 121. Confused with Achmet Yassevi, 120, 122  
 'Kirdjali,' irregulars, recruited from Kirdja by Paswanoglou, 118  
*κόσκινα*, 43 note 3  
 Kyzyl, meaning of, 107 note 1  
 'Kyzylbash' Kurds, connection of, with Bektashi, 98, 101, 103 note 7; equation by, of Mahommedan and Christian Saints, 101, 102; Armenian descent of, 102  
*Katavothra*, in plain of Lasithi, 3, 16
- LARNAX, clay, from L.M. III. Minoan cemetery at Pláti, 14; imitation of wooden chest, *ibid.*; late and degenerate form of, *ibid.*; comparison of, with larnax from Palaikastro, 15  
 Lasithi, plain of, geographical position of, 2; configuration of, 2 ff.; divided into two parts, 3; drainage of, 3, 17; alluvial deposits in, 3, 15; Minoan settlements in, 4 f., 15 f.; date of, 5, 15, 16; cultural connections of, 16 note 1; fertility of, 16; deserted in Venetian period, 1  
 Lead clamps, 132; sling-bullets, *ibid.*  
 Lemnian earth, Thevet's account of, 65
- MACEDONIA, mounds in, *see* Mounds  
 Malpasso, dragon of, 71  
 Maps, mediaeval, of islands of Aegean, 60  
*Meidan*, 95, 96  
 Mekyberna, reputed site of, at Molivopyrgos, 132  
 Messara plain, thickly populated in E.M. and M.M. periods, 16

- Mounds in Macedonia. PREHISTORIC: *Settlements*, near Serfije, 123; pottery from, 123, 124; in Salonica district, 127 ff.; configuration of, 127; depth of prehistoric deposit, 127; pottery from, 129 ff. (see also under Pottery); other finds from, 130; presence of Mycenaean civilization in district proved, 131. *Funereal Tumuli*, in Salonica district: Configuration of, 124; artificial construction of, *ibid.*; theory of use as lookout stations, 126; usually built up over chamber tombs, 124, 125, 126; occur only in districts traditionally occupied by Thracians, 127. HISTORIC: Greek Settlements, 127, 128, 131 ff.; configuration of, 131, winding paths up mounds, 132; pottery etc. from, 132 (see also under Pottery)
- NAKSHBENDI, order of Dervishes, 99; sheikh of, in Bektashi *tekke*, 99
- Namazgiah, columns of, in Jewish quarter at Smyrna, 87
- Nymphaea of Aqua Traiana at Smyrna, 93
- OLYNTIUS, reputed site of, at Myriophyto, 132
- PLATI, in Lasithi, situation of, 4 ff.; Minoan settlements at, 1, 4, 5 ff., 15 ff. Archaic Greek settlements at, 2, 10, 11, 12, 13, 16. Modern village burnt by Turks, 5; rebuilt from Minoan remains, *ibid.* Probably contemporary with cult of Psykhro cave, 15, 16. Configuration of site, 4. Epáno Kepháli, Minoan walls and L.M. III. sherds, found on, *ibid.*; bronze weapons found on, *ibid.* Káto Kepháli, Minoan remains on, 5ff. EXCAVATION: Chronological sequence of buildings on, 5, 6. Small amount of movable finds from, 6; buildings dated by finds of pottery in, *ibid.* *Earliest Period*, L.M. I., 6; walls belonging to, construction and height of, 7; early road in, *ibid.* Pottery from: unpainted, 6; pithos from, 10: painted, 6, 7; technique of, 6; mixture of styles on, 7. *Later Period*, L.M. III., 7. Three blocks of buildings, 7 ff.; arrangement of, round open space, 7, 8; central hearth in, 7; ashes and sherds from, 8. Unusual character of plan, 8; comparison with Knossos and Palaikastro, 8. Block C: plan much destroyed, 8; plaster floors in, *ibid.* Block B: ground plan of, preserved, 8; entrance on central court, 9; traces of re-building in, *ibid.*; central passage in, 9; found also on Mycenaean site of Sparta, *ibid.*; houses probably contemporary, *ibid.* Block A: plan of, 9 f.; built over L.M. I. house and road, 9. House with double porticoes and inner courts, and entrance corridor, 9; Western portico, dimensions of, 11; free and engaged column-bases in, *ibid.*; later Greek walls in, *ibid.* Eastern portico, dimensions of, 12; square pillar-bases in, *ibid.*; L.M. I. walls in, *ibid.*; later Minoan alterations, 12; Greek walls in, *ibid.* *Archaic Greek Period*, Date of, 13; remains from, 12 f.; construction of walls of, 12; plan of, destroyed, *ibid.* Finds: impressed pithoi, 13; cooking pots, *ibid.* Site uninhabited between L.M. III. and Archaic Greek periods, 13
- Minoan cemetery of settlement, position of, 4, 13
- Beehive tomb with dromos at τὰ Σκαλία, 13. Construction of tholos, 14; dimensions, 13. Two interments in, 13, 14. Clay larnax from, 14; contents of, *ibid.*; date of, 14, 15. Construction and dimensions of dromos, 14, 15; built without outlet, 14; reasons for, 15; mainland influence on, *ibid.*
- Pottery; from Macedonia; Prehistoric. *Handmade*: plain, 123, 124, 129; decorated with incised patterns, 124, 129; painted, (a) brown-violet decoration on brown ground, 130; (b) black patterns on brick-red surface, *ibid.* *Wheel-made*: imported Mycenaean of mainland fabric, 130; painted, of 'Geometric' style, red-brown pattern on cream ground, possibly local, 130. From Greek sites: 'Geometric,' 132; Proto-Corinthian, 128, 132; black-glazed of 4th and 5th centuries, 128, 132; Megarian bowls, 132; late Hellenistic ware, *ibid.* From Pláti in Crete. L.M. I., unpainted, 6, 10; painted, 6, 7, 9. L.M. III. false-necked amphorae, 6. Greek pithoi with impressed ornament, 6, 12; plain cooking pots, 6, 12

- Psykhro, Cave of, cult at contemporary with Minoan and Greek settlements at Pláti, 15, 16
- ROMAN aqueducts at Smyrna, 92 f.
- Roumeli, Bektashi propaganda in, 110 f.
- S. BASIL, festival of, 32; carols in honour of, 32 ff.: types of, I. 'The Staff that budded,' 34 ff. II. 'The Love Song,' 37 f.; developed from I., 37. III. 'The Golden Tree,' 40 f. IV. 'The Husbandmen,' 42 f. Construction of, 51 f.: preludes, 35, 37, 39, 41, 44, 49, 51. Carols proper, 35 f., 37, 41, 44, 48 f. Praises of Master, 36, 40, 45, 50, 53 f.; of Mistress, 36, 40, 41, 46, 50, 54 f.; of Daughter, 40, 46, 55 f.; of Son, 41, 45, 56. Conclusions, 37, 40, 41, 43, 46 f., 51, 54
- S. Boukolos, 80 note 2
- S. Charalambos, tomb of, in Bektashi *tekke*, 102; legend concerning, *ibid.*
- S. Eusebia, (= S. Xene), church and relics of, 109
- S. Eustathius, legend of, 103
- S. George, identified by Moslems with Kídr, 101
- S. John, 'church' of, at Smyrna, 85, 88, 90, 92; other monuments in town, connected with, 86 f. Greek tradition of burial, 87. Confusion of, with S. Polycarp, 81, 82, 83, 85
- S. Martha, subdues the dragon of Tarascon, 78
- S. Naoum, identified by Bektashi with Sari-Saltik, 107, 111, 116
- S. Polycarp, historical facts concerning, 80 and *ibid.* note 2. Turkish tradition concerning, 81; relics of, 86: 'Tomb' of, at Smyrna, 80 ff.; references to, by 16th and 17th century travellers, 81, 82, 83, 84. Varying position of, 81, 83, 84; changed hands in 17th century, 82 f. Other monuments at Smyrna, connected with, 87 f. Confusion of, with S. John, 82, 83
- Sari Saltik, lay-figure of Bektashi propaganda in Roumeli, 106 f.; meaning of name, 107 note 1
- 'Songs of the Star,' 33
- Stone, seat, 89 note 13; vases, 6; water-pipes, 92
- Smyrna: Castle of, held by Knights of Rhodes (1344-1402) 86; taken by Timour (1402) *ibid.* Town sacked by Venetians (1472), *ibid.* Topography of ancient site: Ruins on Castle Hill, called by various names, 88, 89; description of, in 17th century, 90, 91; used as quarry for building material in 18th century, 90. Possible identification of, with Nymphaea of the *Aqua Traiana*, 92, 93
- Taj*, 82 note 3; on 'Tomb' of S. Polycarp, 81
- Talismans, 75, 76 note 3
- 'Tarasque' of Tarascon, legend of, 77 f.
- Tekke*, 95; Bektashi, frequented by Christians, 102 f.; of Turbe Ali Sultan, in Thessaly, 110
- Thessaly, prehistoric culture of, extent of, 124
- Thevet, André, career of, 67 note 5; travels of, in Levant, 61, 63 f.; in Brazil, 67 f. Works by, 59, 61, *ibid.* note 4, 64, 68, *ibid.* note 2. Sources of information, 60, 62, 64, 67, 68 f. References to Jews by, 61 f.; reliability of author, 62, 63, 67, 69. Contemporary estimates of, 67, 68
- Tombs: chamber, in Thrace, 126, 127; painted decoration of, 125, 126. Cist, in Crete, 14; 15. Beehive, at Pláti, 13 ff.
- Τούμβες, 124
- Tsakonian folk tales, from Lenidhi, 18, 19, 21; from Melana, 22, 23; from Tyros, 24, 25; from Kastanitsa, 27, 28, 29
- Tudela, Benjamin of, 62
- Vasilca*, 33
- Vipers, 61, note 5; 126
- 'WOOD' pattern on L.M. I. vase
- Wooden chest-larnax, imitated in clay, 14
- YOUSSEUF DEDE, tradition of, at Smyrna, 85

MINOAN HOUSES AT PLATI  
LASITHI  
CRETE.  
1914.

References

-  . . . . . Late Minoan I.
-  . . . . . Late Minoan III.
-  . . . . . Greek.

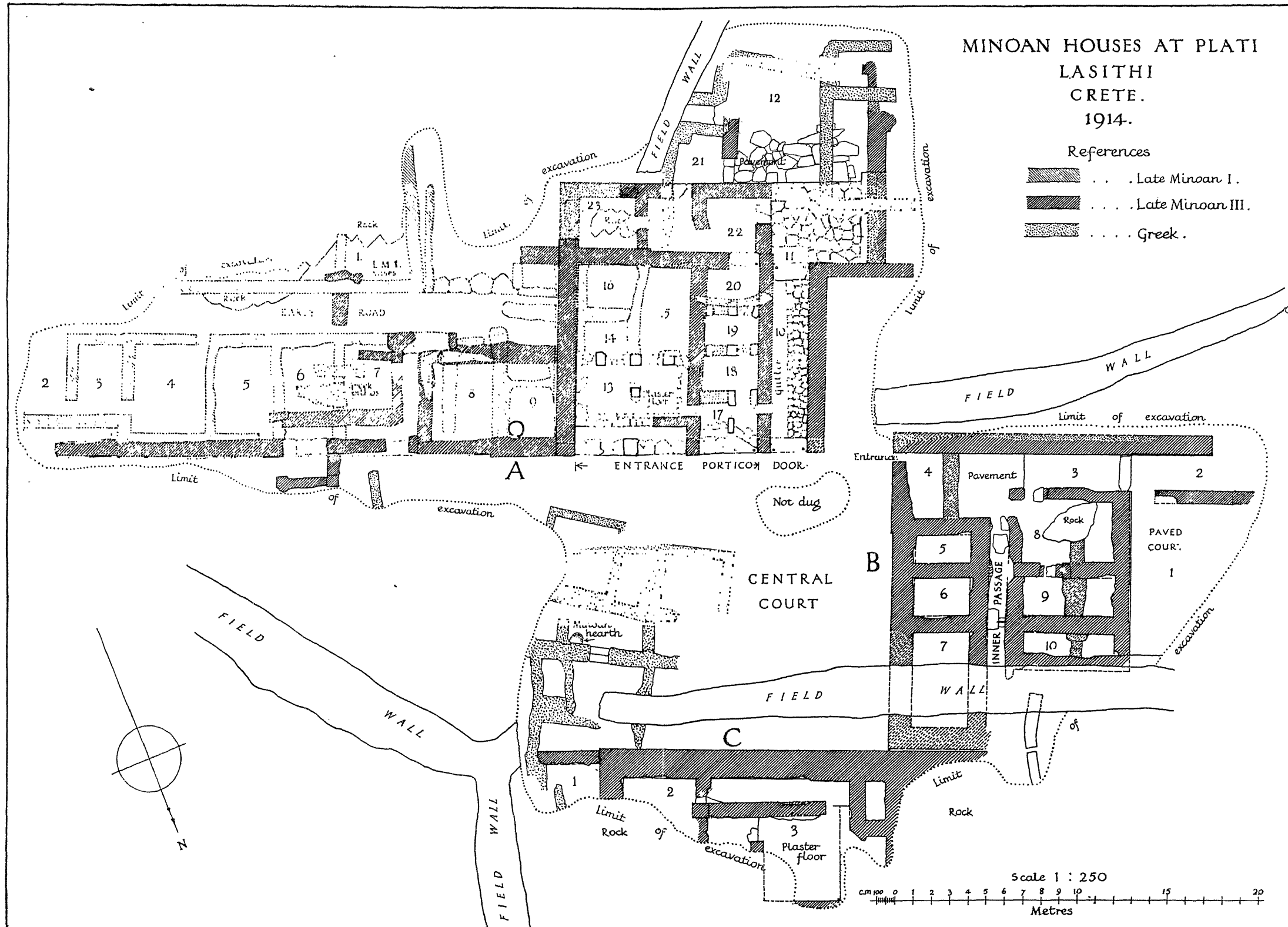



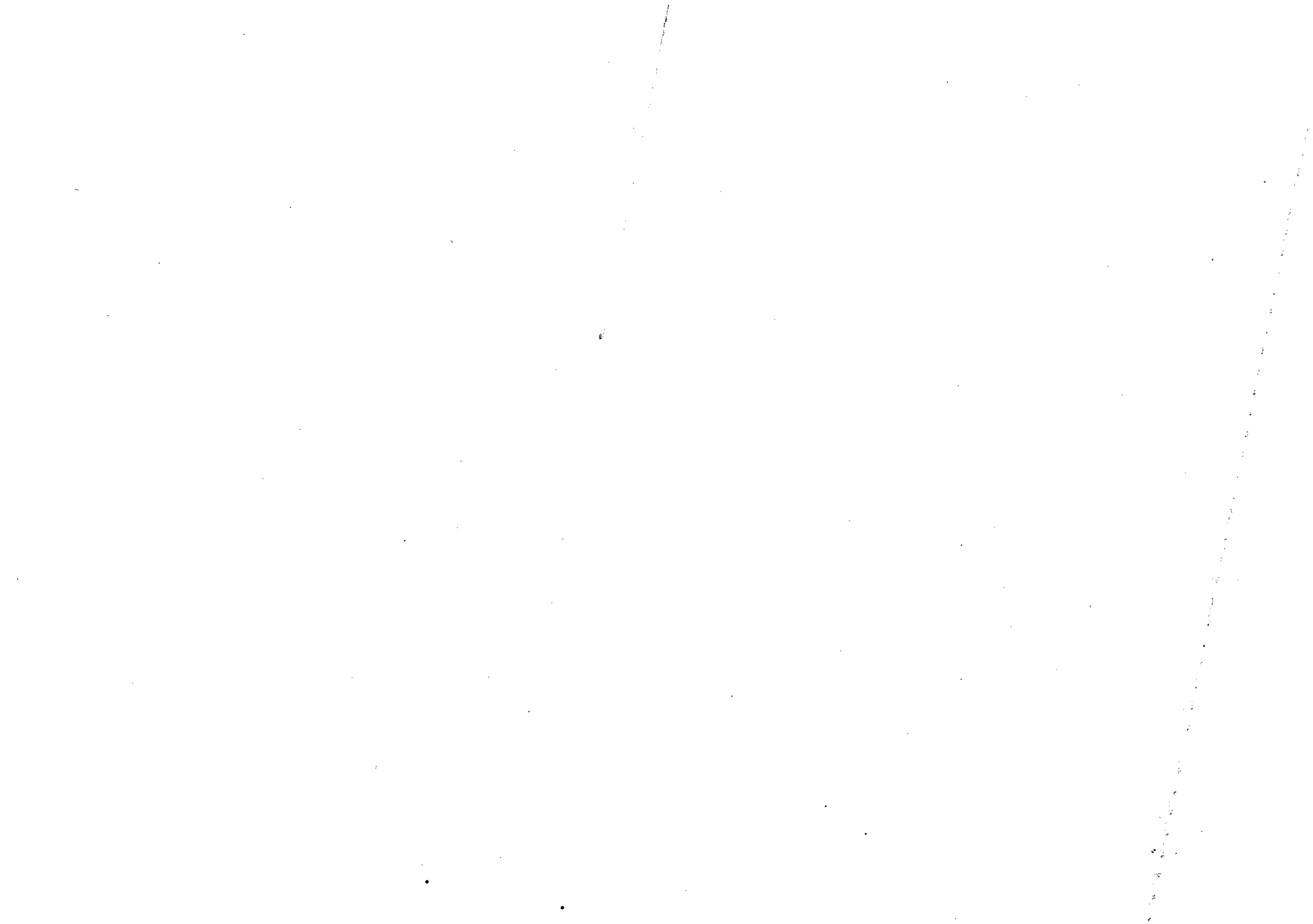

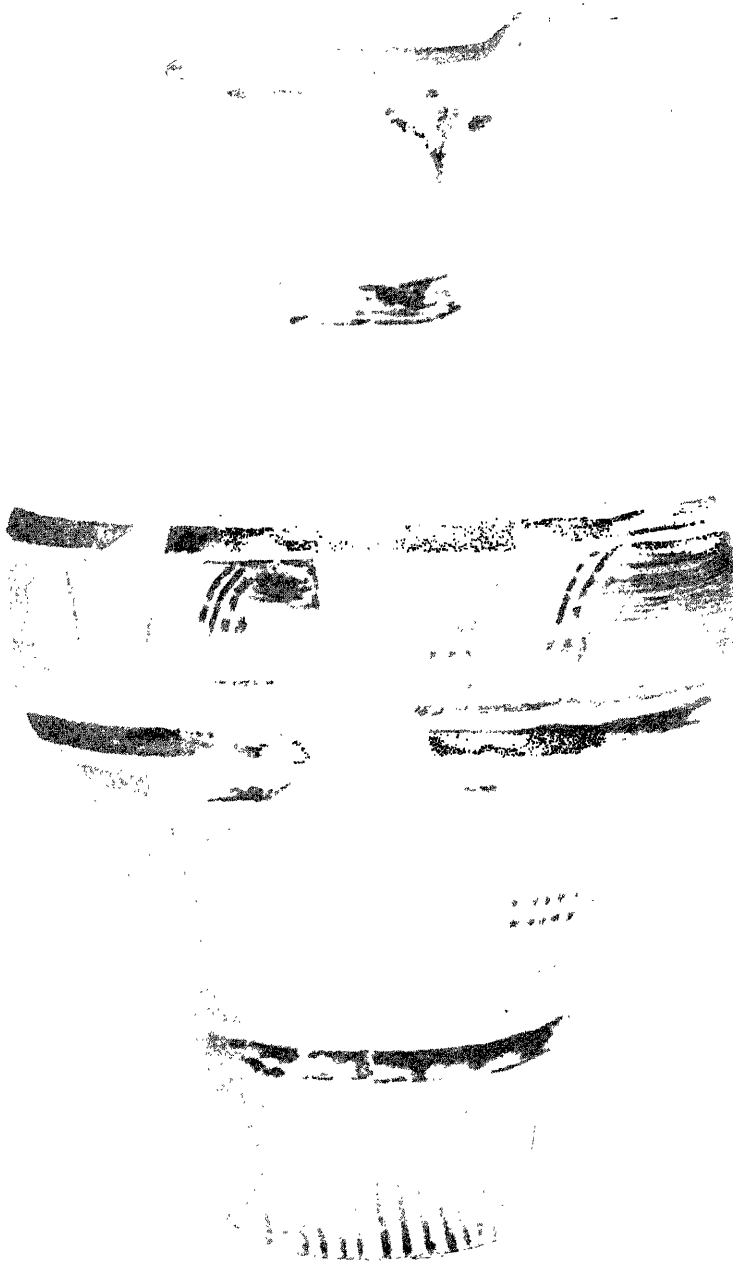

EXCAVATIONS AT PLATI: LATE MINOAN I. VASE (Scale 1 : 2).





EXCAVATIONS AT PRATI: BLOCK A.—*a*, Frontage on Central Court with Entrance Porfico, *b*, Pithos from A. 9, *c*, Rooms A 4, 5, 6, 7, behind them, early Road; in Foreground, Angle of Wall in Front of A 6, BLOCK B.—*d*, paved Court (B 1, 2); Middle Distance, Epmano Kephali; Horizon, the Peak of Alcibi Sarakinos.





*b*



*d*

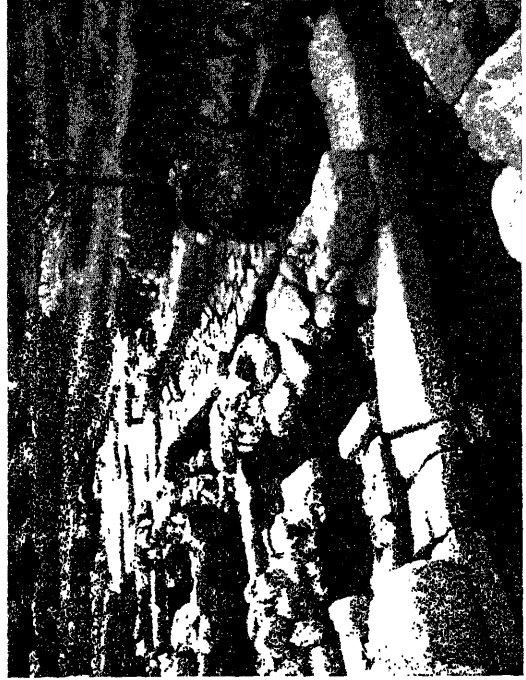

EXCAVATIONS AT PLATI: BLOCK A.—*a*, Entrance Corridor (A 10) and Inner Courts (A 11, 12) beyond; on the Left, Back of Western Portico (A 19, 20). *b*, Inner Courts, showing two steps between; Peak of Diké in the Background. *c*, Front Room (A 13) of Eastern Portico; Middle Distance, Village of Gerondonouri. *d*, Western Portico (L.); Entrance Corridor (R.).



a



b

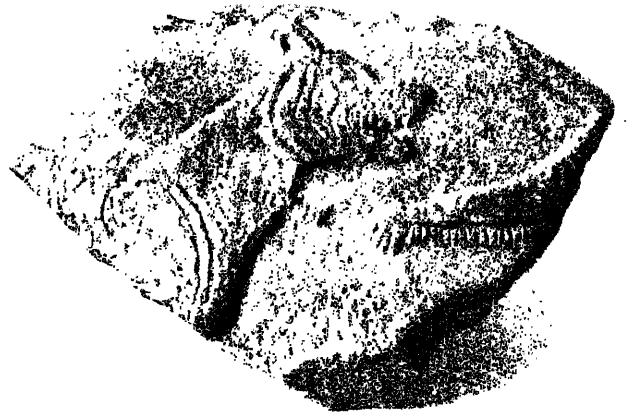
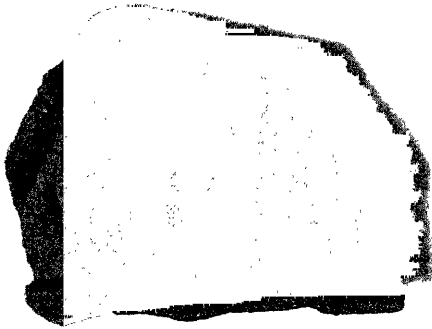
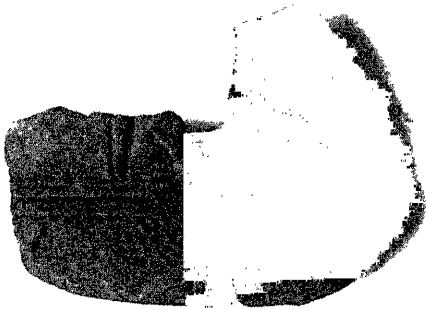

c

d

EXCAVATIONS AT PLATI: GREEK OBJECTS.—a, BRONZE RELIEF OF A DANCER (Scale 1 : 1). b, c, FRAGMENTS OF STAMPED PITHOI (Scale 1 : 1). d. *Ibid.* FROM GEMBOROS, BETWEEN LASITHI AND VIANO (Scale 1 : 1).



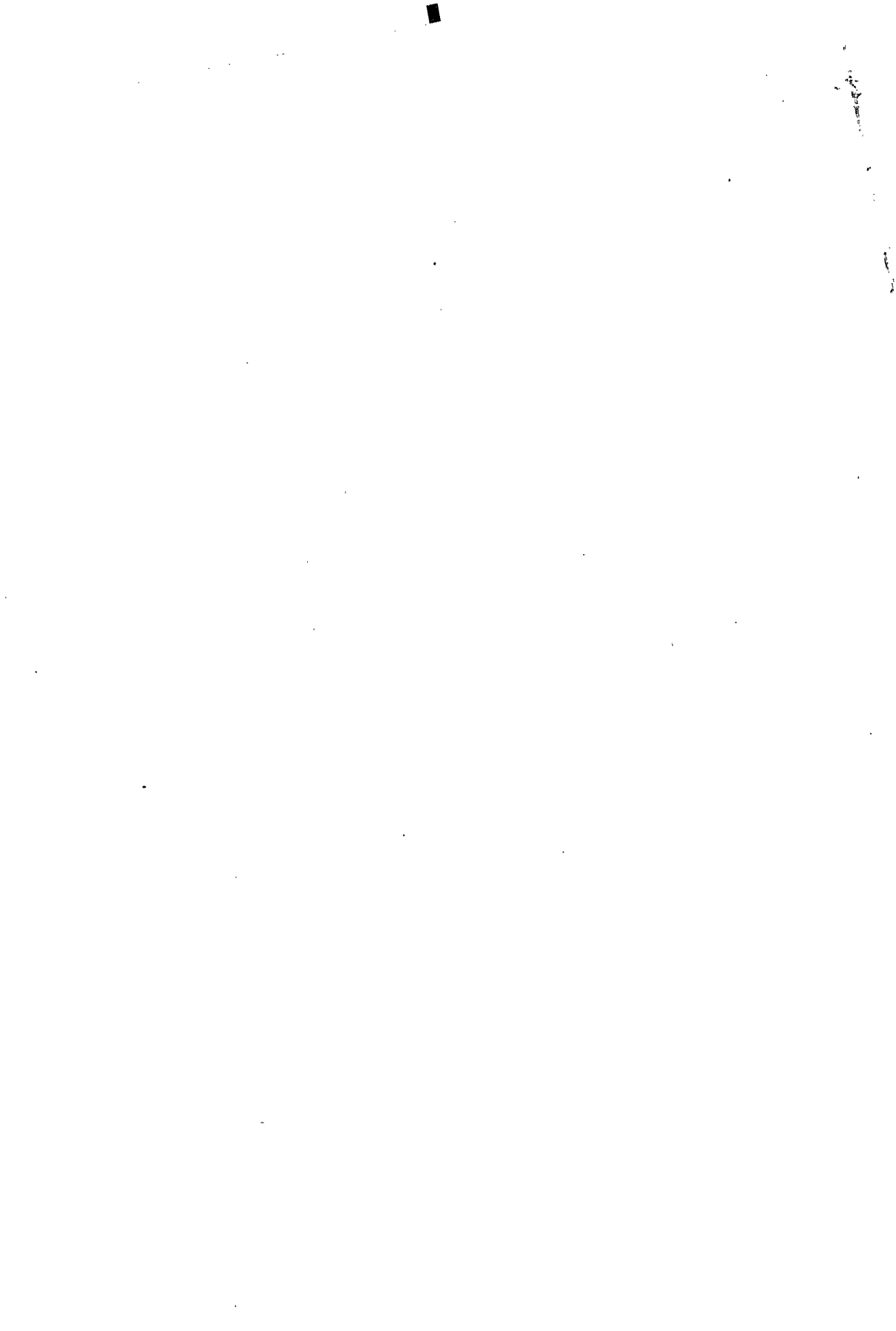

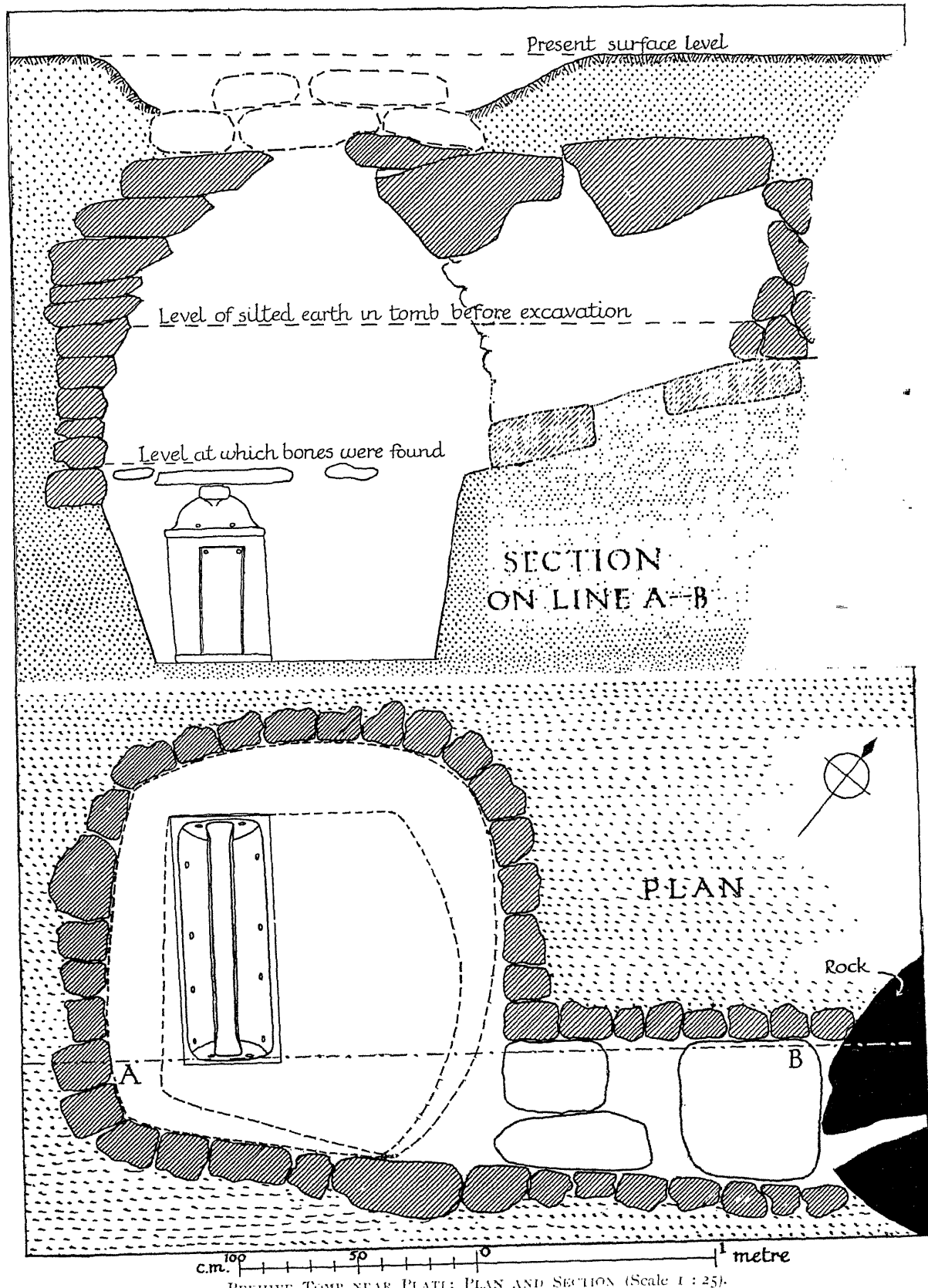

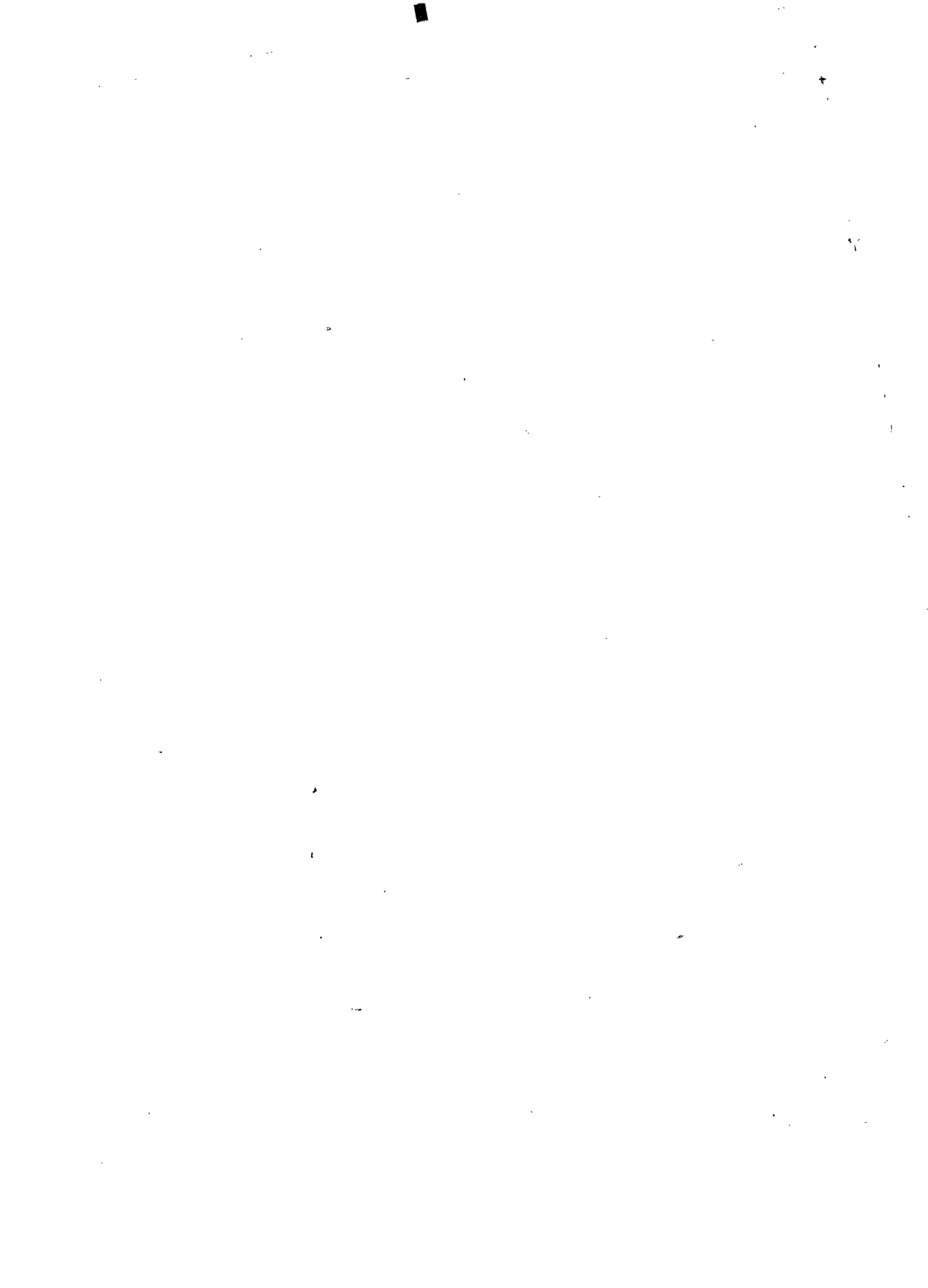

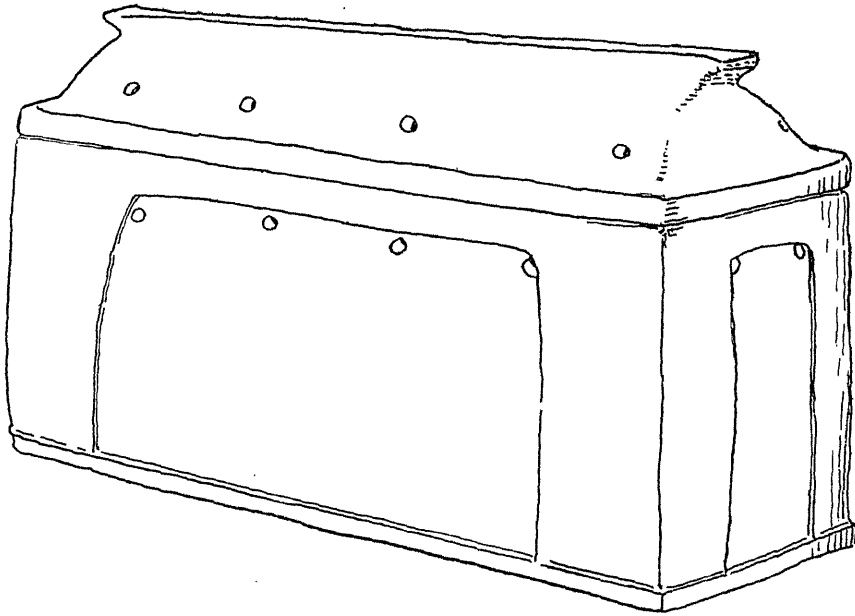

1. BEEHIVE TOMB NEAR PLATI: CLAY LARNAX (Scale 1 : 10.)

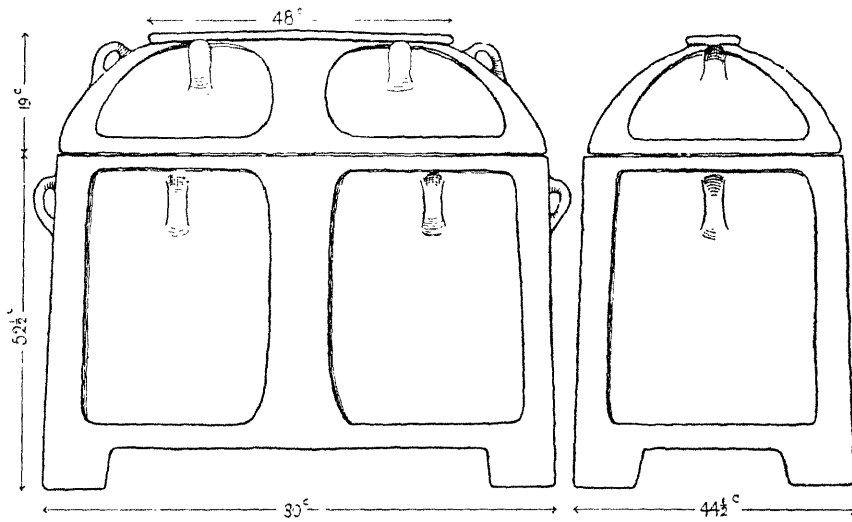

2. PALAIKASTRO: CLAY LARNAX WITH SUNK PANELS.

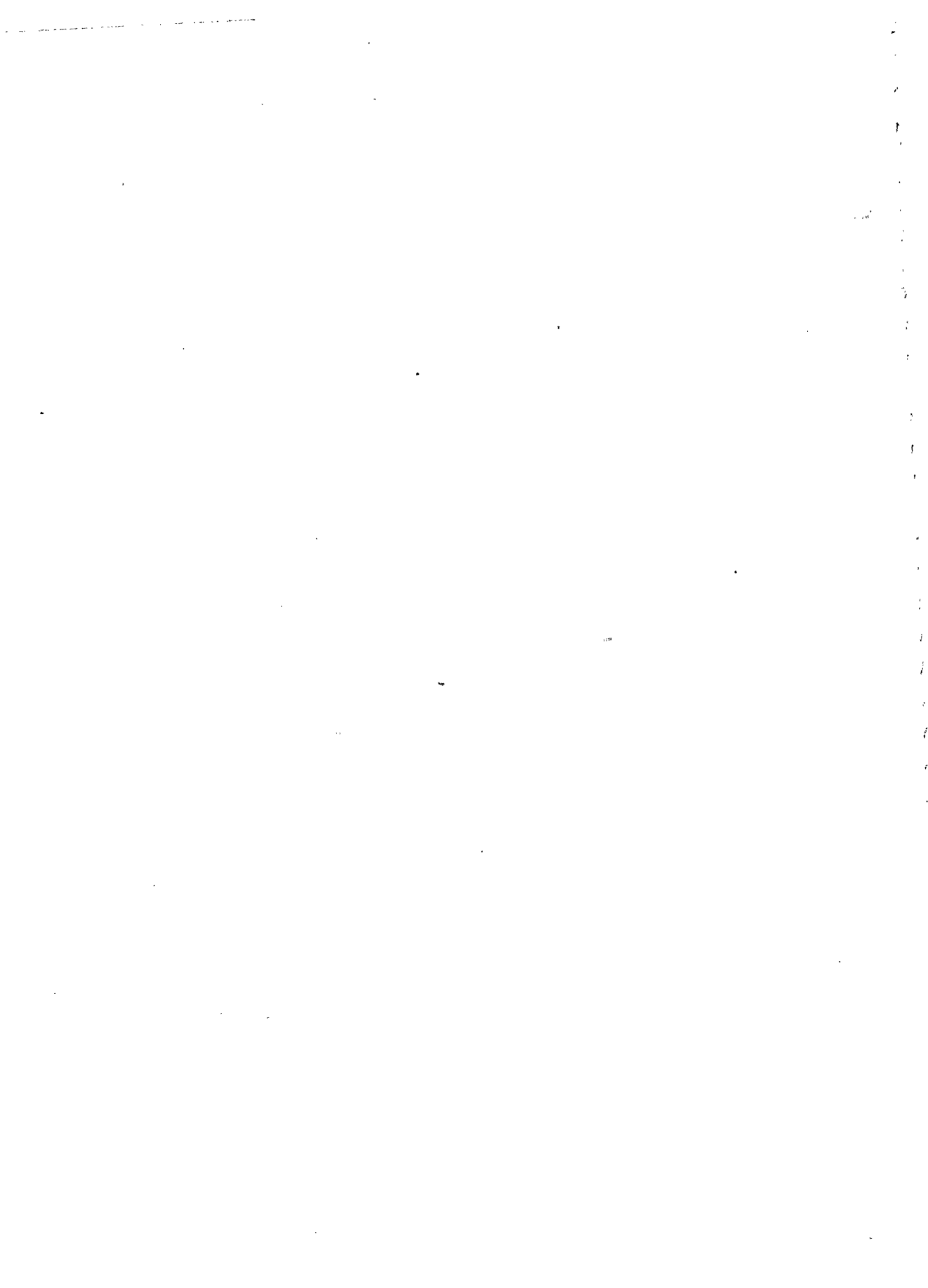

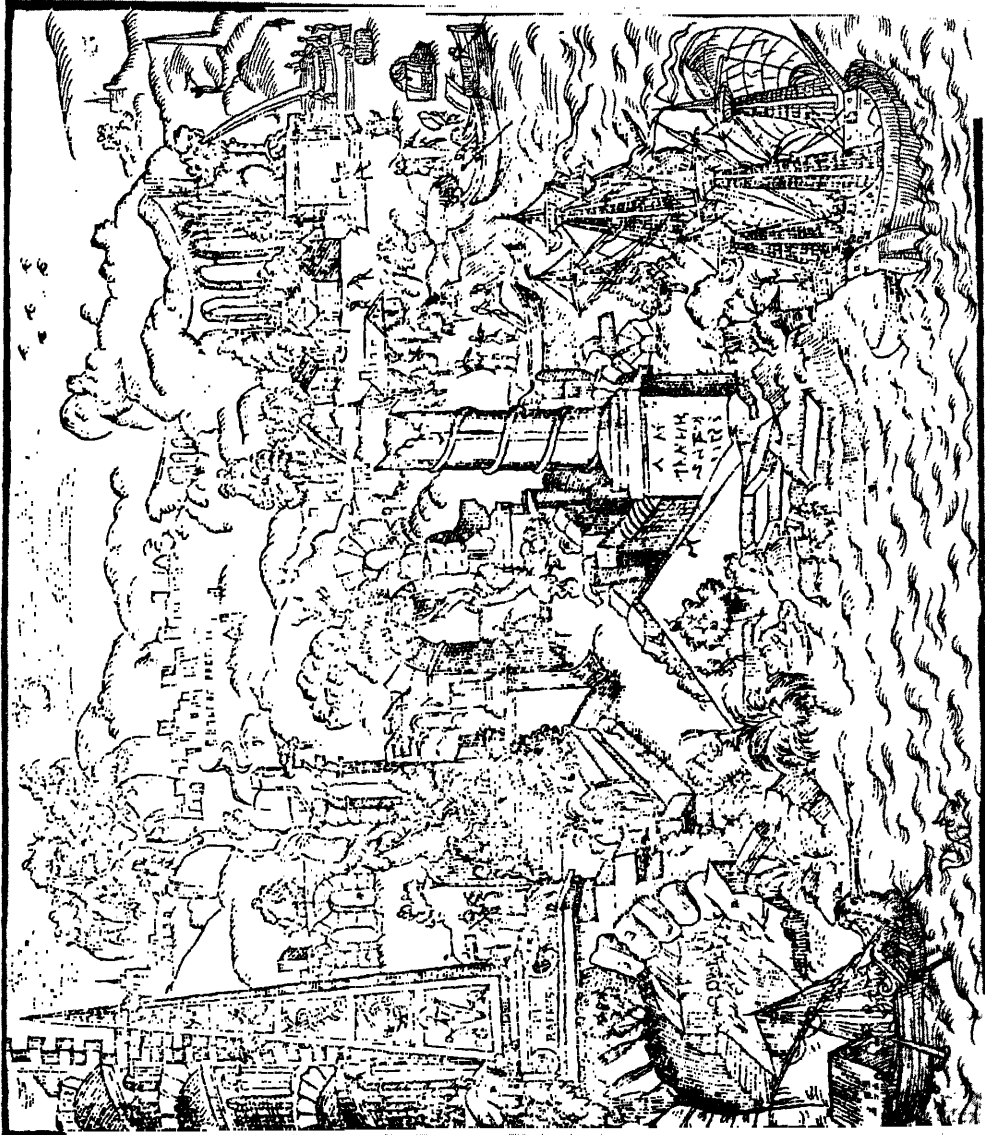

THEVET'S *Grand Insulaire*: VIEW OF ATHENS AFTER THE *Cosmographie Universelle*.



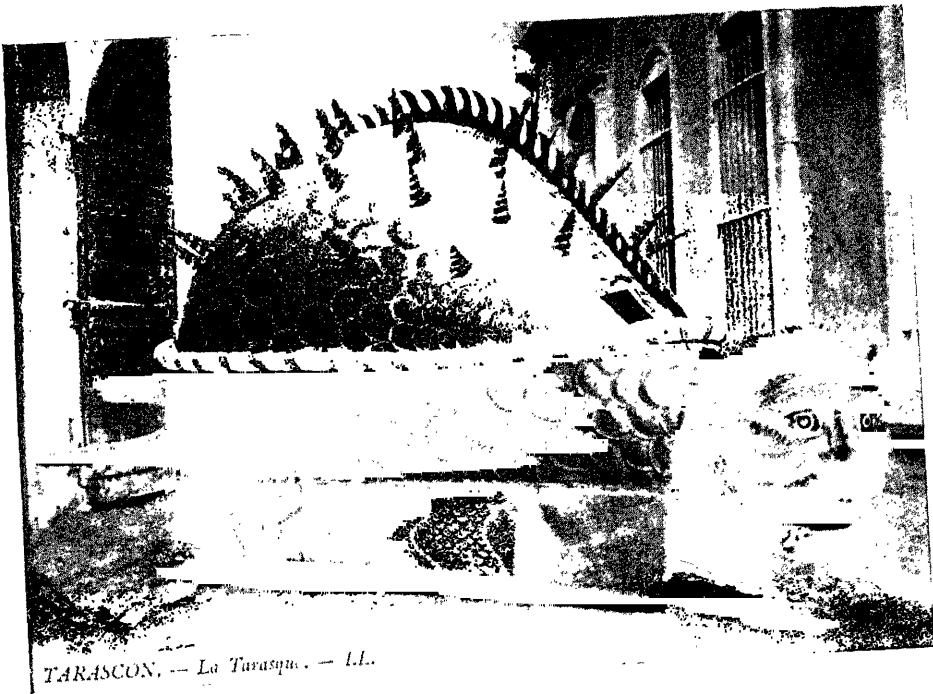

TARASCON. -- *Le Tarasque*. -- II.

DIEUDONNÉ DE GOZON: THE '*Tarasque*' OF TARASCON.



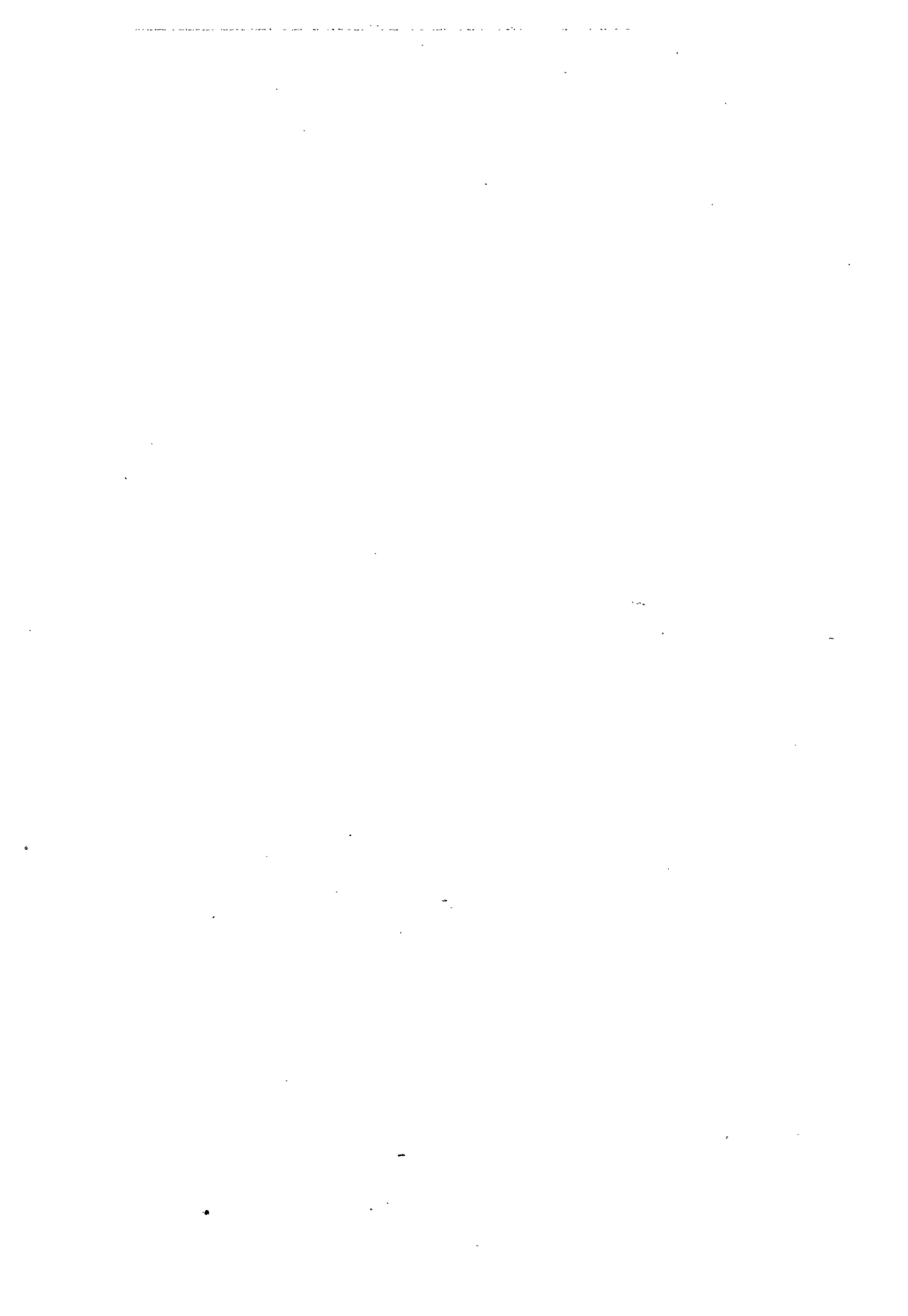



1

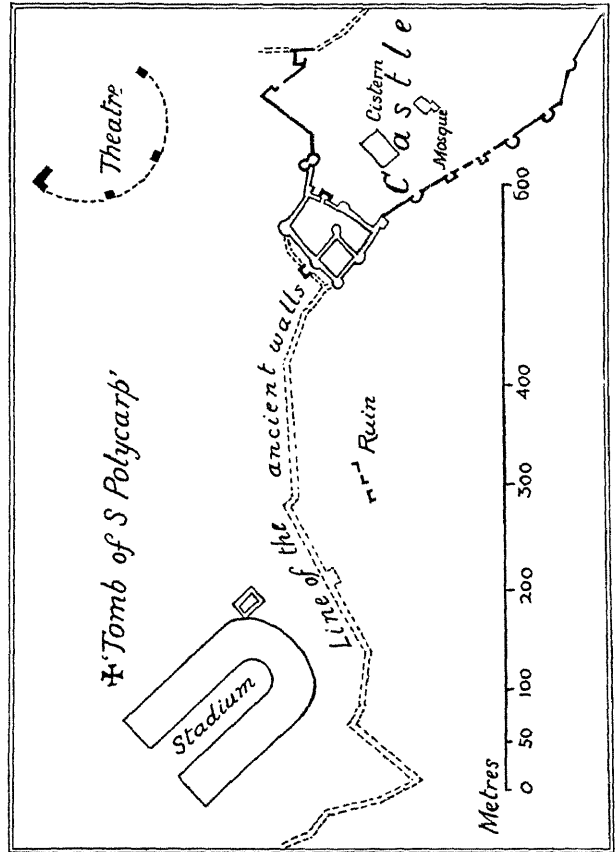

2

THE TOMB OF S. POLYCARP: 1.—VIEW OF THE TOMB. 2.—PLAN OF SMYRNA AFTER SPORKAL. AFTER DRUMMOND'S *Travels*.

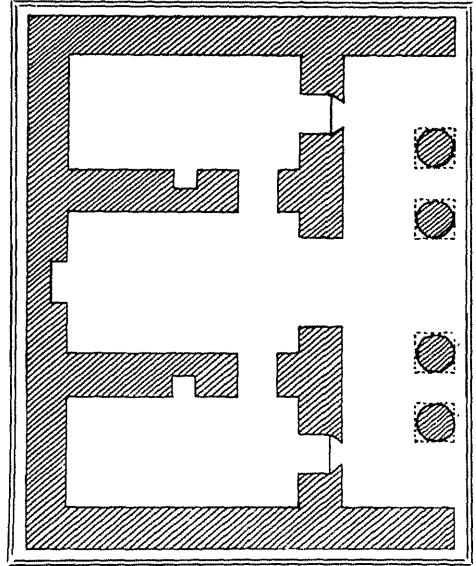

3

3.—PLAN OF THE 'JUDICATORIUM'





THE TOMB OF S. POLYCARP: VIEW OF SMYRNA AFTER LE BRUYN'S *Voyage*.



PRINTED IN GREAT BRITAIN BY  
RICHARD CLAY AND SONS, LIMITED,  
BRUNSWICK STREET, STAMFORD STREET, S.E.1, AND  
BUNGAY, SUFFOLK.

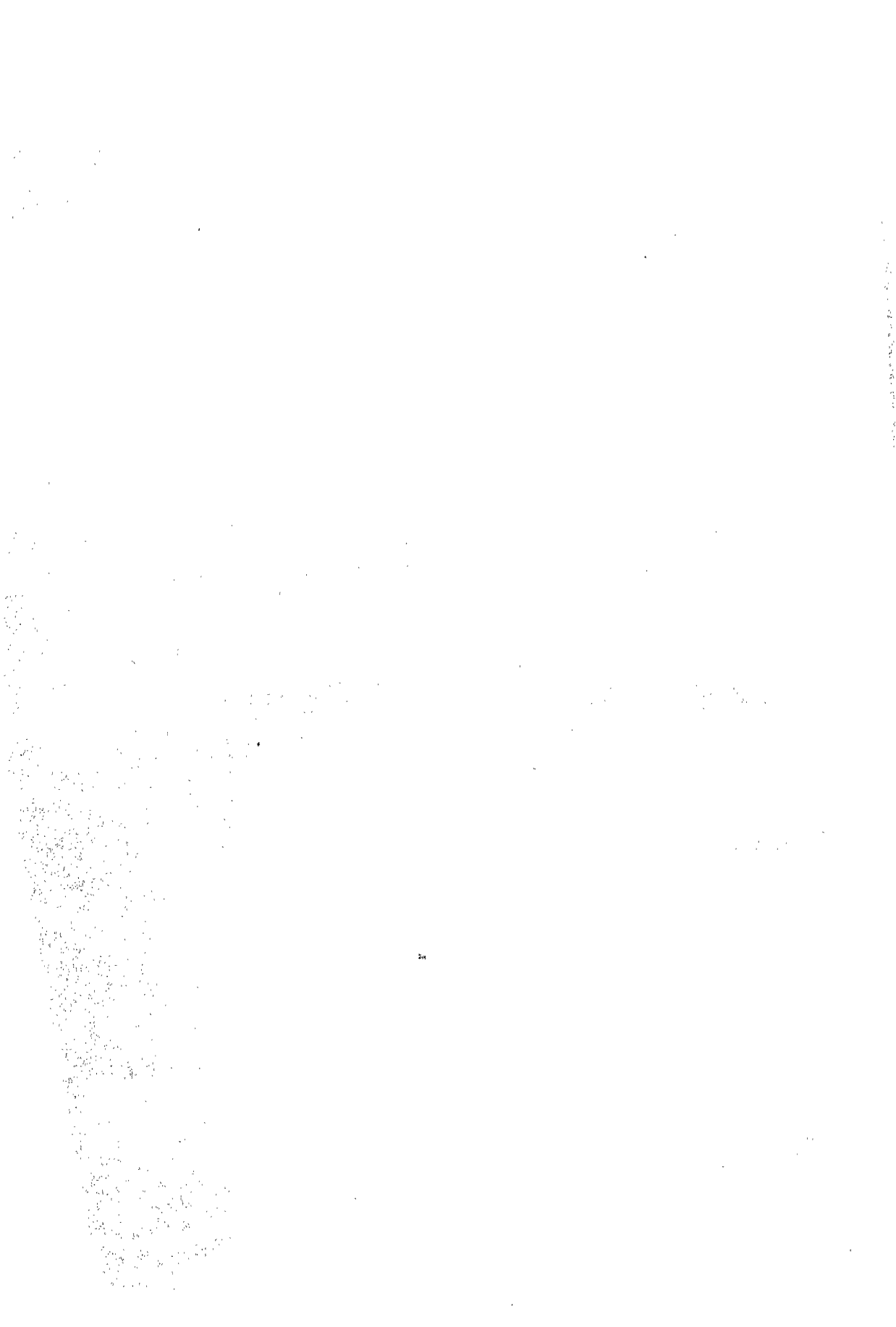

*"A book that is shut is but a block"*

CENTRAL ARCHAEOLOGICAL LIBRARY

GOVT. OF INDIA  
Department of Archaeology  
NEW DELHI.

Please help us to keep the book  
clean and moving.