



This is a digital copy of a book that was preserved for generations on library shelves before it was carefully scanned by Google as part of a project to make the world's books discoverable online.

It has survived long enough for the copyright to expire and the book to enter the public domain. A public domain book is one that was never subject to copyright or whose legal copyright term has expired. Whether a book is in the public domain may vary country to country. Public domain books are our gateways to the past, representing a wealth of history, culture and knowledge that's often difficult to discover.

Marks, notations and other marginalia present in the original volume will appear in this file - a reminder of this book's long journey from the publisher to a library and finally to you.

Usage guidelines

Google is proud to partner with libraries to digitize public domain materials and make them widely accessible. Public domain books belong to the public and we are merely their custodians. Nevertheless, this work is expensive, so in order to keep providing this resource, we have taken steps to prevent abuse by commercial parties, including placing technical restrictions on automated querying.

We also ask that you:

- + *Make non-commercial use of the files* We designed Google Book Search for use by individuals, and we request that you use these files for personal, non-commercial purposes.
- + *Refrain from automated querying* Do not send automated queries of any sort to Google's system: If you are conducting research on machine translation, optical character recognition or other areas where access to a large amount of text is helpful, please contact us. We encourage the use of public domain materials for these purposes and may be able to help.
- + *Maintain attribution* The Google "watermark" you see on each file is essential for informing people about this project and helping them find additional materials through Google Book Search. Please do not remove it.
- + *Keep it legal* Whatever your use, remember that you are responsible for ensuring that what you are doing is legal. Do not assume that just because we believe a book is in the public domain for users in the United States, that the work is also in the public domain for users in other countries. Whether a book is still in copyright varies from country to country, and we can't offer guidance on whether any specific use of any specific book is allowed. Please do not assume that a book's appearance in Google Book Search means it can be used in any manner anywhere in the world. Copyright infringement liability can be quite severe.

About Google Book Search

Google's mission is to organize the world's information and to make it universally accessible and useful. Google Book Search helps readers discover the world's books while helping authors and publishers reach new audiences. You can search through the full text of this book on the web at <http://books.google.com/>

Bankers magazine

1G1501
R3

v.95

Library of
Princeton University.



The Eighty Eight Library
of
Economics.

HG1501
B3

*95

Library of
Princeton University.



The Eighty Eight Library
of
Economics.

THE
BANKERS MAGAZINE

VOLUME XCV
JULY TO DECEMBER
1917

NEW YORK
THE BANKERS PUBLISHING CO., PUBLISHERS
253 BROADWAY

H618
B5
V. 100

COPYRIGHT 1917
BY THE
BANKERS PUBLISHING CO.

YERGEN
YERGEN
L. 100 100

INDEX

July to December 1917

I. EDITORIAL COMMENT AND LEADING ARTICLES

- Advertising, direct464, 655
Advertising possibilities of pay envelopes 342
Advertising to make loans..... 599
Aiken, Alfred L., portrait of..... 753
Alexander, James S., portrait of..... 163
Amendment of June 21 1917—Federal Reserve Act 211
American banking, development of...5, 7, 163
American banking, future responsibilities. 7
-American banking in foreign countries, 5, 7, 163
-American banks in foreign trade..... 230
-American Foreign Banking Corporation, 164, 172
Amortizing method for small mortgage loans 323
Appleby, Forest L. (money and war).... 344
Appleby, Forest L., portrait of..... 345
Are school savings banks worth while to the banker? 770
Atlantic City convention.....451, 313, 563
Australia and America united in common cause 491
Bank depositors in United States..... 756
Bank examiners—criticism 452
Bank loans 662
Bank of England, a new governor..... 456
Bank of Montreal, centenary of..... 759
Banker and his customer..... 602
Bankers' convention313, 451, 563
Banking, Governmental, extension of... 320
-Banking, International5, 7, 163
Banking and business training for women 212
Banking and life insurance..... 20
Banking service for women.....24, 157
Barrett, John (war and the new America—the new Pan-America)..... 621
Barrett, John, portrait of..... 621
Billion-dollar bank 758
Bogart, Ernest L. (taxation of wealth), 177, 167
Bolivian products, exhibition of..... 245
Bond issues 486
-Brand Hon. H. B. (problems relating to financing foreign governments)..... 605
Business building20, 184, 342, 464, 635
Business counselor—the new factor in banking29 204, 353
Business, evolution of..... 15
Business readjusted to meet war conditions 29
Canada's financial and commercial relation with the United States.....9, 163
Canadian banks in the United States.... 453
Carson, Major-general Sir John W., portrait of 216
Case against Germany 616
Centenary of the Bank of Montreal.... 759
Change in reserve requirements..... 167
Change in the form of bank settlements. 317
Chemical Bank's change of policy..... 2
Chile, monetary situation in..... 234
China's new banking law..... 245
Circulation of notes 168
Clausen, John, portrait of..... 648
-Clausen, John (new era of American international trade and finance)..... 648
Commercial borrowers can create liquid banking position 228
Convention at Atlantic City ...451, 313, 563
Country banks, earnings..... 338
Country's new financial responsibilities.. 765
Cultivating old business and securing new business by direct advertising... 635
Cunliffe, Lord, of Headley, portrait of.. 451
Cunliffe, Lord, of Headley, governor of the Bank of England..... 456
Davis, E. L. (refunding mortgage)..... 323
Dawson A. F. (patriotic summons).... 347
Dawson, A. F., portrait of..... 347
Dean, Rodney (emancipated Russia)... 231
Development of American Banking...5, 163
Development of the Japanese investment market and co-operation of U. S. 796
Direct advertising464, 635
Distribution of wealth.....169, 177
Durland, John S. (monetary situation in Chili) 234
Durland, John S., portrait of..... 235
Efficiency20, 464, 635
Emancipated Russia61, 231
England and war finances..... 605
Enthusiasm vs. apathy 461
Experience with the woman's department 187
Export engineering and contracting.... 215
Evolution of business..... 15
Federal Land Bank activity..... 175
Federal Reserve Act, Trust company provision upheld6, 173
Federal reserve requirements changed in national banks 167

Federal Reserve System—list of banks. 603, 793	Liberty loan, success of..... 1
Federal Reserve System, uniting banks through 764	Liberty loan of 1917.....208, 319, 327, 376
Financial relation of Canada and U. S. 3	Liberty loan proclamation 597
Financial Russia 41	Life insurance and banking..... 20
Financing foreign governments..... 605	Ludwig, Augustus (are school savings banks worth while—to the banker?). 770
Foreign banks, organization of..... 172	McAdoo, William G. (case against Germany) 616
Foreign banking, American.....5, 7, 163	McAdoo, William G., portrait of.....587, 617
Foreign department, organization of.... 383	Making the dollar work..... 787
Foreign exchange facilities in Venezuela 246	Monetary situation in Chile..... 234
Foreign trade, American banks.....239	Money and the war..... 344
French, John M. (making the dollar work) 787	Money, suggested economy in paper.... 317
Further extension of governmental bank- ing 320	Morehouse, W. R. (talks on business building)20, 184, 342, 464, 635
Future responsibilities of American banking 5, 7	Mortgage, refunding 323
Getting women to bank at your bank.. 24	Mexico, proposed borrowing by 171
Gibson, Harvey D., portrait of..... 1	National Bank gives up circulation.... 163
Giving ungrudging support..... 312	National banks, record figures for.... 314
Graff, E. A. (American banks in foreign trade) 239	National banks with trust company powers6, 173
Haas, H. J. (how we handle Liberty Bond clubs) 348	National banks—change in Federal Re- serve requirements 167
Half of Japan's new loan to go for rail- road work 243	Neglected opportunity 452
Hamilton to have statue at Washington. 4, 58	New era of American international trade and finance 618
Hashimoto, K. (development of Japanese investment market and co-operation of U. S.) 796	New York State banking department, new superintendent of..... 225
Hashimoto, K., portrait of..... 796	New York University in Wall Street.... 448
Holman, Willam A. (Australia and America united in common cause).... 491	Newell, E. J. (evolution of busness).. 15
How to handle Liberty Loan subscrip- tions 208	No diversion from the main purpose of war 455
How we handle Liberty Bond clubs.... 348	Organization of a foreign department.. 322
How will banks fare under present con- ditions 600	Other hundred million 319
Improving the earnings of country banks 338	Our present task 311
Income tax 177	Parsons, George K. (business counselor— the ne wfactor in banking)...29, 204, 353
Increased number of investors..... 763	Parsons, George K. (is the financial statement false gospel?)..... 353
International trade and finance.....239, 649	Parsons, George K. (keeping a business up to date) 204
International banking, reciprocity in.... 768	Parsons, George K. (readjusting business to meet war conditions)..... 24
International banking and finance, 5, 7, 163, 383, 647, 795	Patriotic summons 347
Investigate industrial conditions in South America 242	Patriotic views of an American of Ger- man birth 226
Investors, increased number of..... 763	Patriotism at Atlantic City..... 313
Is the financial statement false gospel?.. 353	Pay envelopes, advertising possibilities of 342
Ishii, Viscount, portrait of.....490, 670	Political capitals and legislation..... 4
Japan, prosperity of..... 804	Price, Lieut.-Colonel Sir William, por- trait of 217
Japan and the United States reach an agreement 766	Problems relating to financing foreign governments 605
Japanese investment market and co-op- eration of the United States..... 796	Proclamation calling on the nation for subscriptions 597
Japan's new loan 243	Proposed borrowing by Mexico..... 171
Jones, Harry T. (enthusiasm vs. apathy) 461	Prosperity of Japan 904
Kahn, Otto H. (patriotic views of an American of German birth)..... 226	Railroad situation 757
Keeping a business up to date..... 204	Readjusting business to meet war condi- tions 23
Keeping up the value of securities..... 760	Record figures for the national banks.. 314
Large number of bank depositors in the U. S. 756	Reciprocity in international banking.165, 768
Liberty bond clubs 348	Rediscounting not yet popular..... 765
	Refunding mortgage 323
	Relating the bank to life insurance.... 20
	Report on Liberty Loan publicity..... 327

Reserve requirements under the amendment of June 21, 1917.....167, 211

Robinson, Harold A. (organization of a foreign department) 383

Russia, emancipated61, 231

Russian market: its possibilities and problems 498

Sack, A. G. (Russian market; its possibilities and problems) 498

School savings bank184, 770

Scientific business building, 20,184,342,464, 635

Securities, keeping up value of..... 769

Significant and eloquent speech on the life of Washington..... 490

Skinner, G. I., portrait of..... 225

Smaller bank bills 607

South America, industrial conditions in. State banks and trust companies join Federal Reserve 792

Suggested economy in paper money.... 317

Success in business 461

Success of the liberty loan.....1, 761

Talks on business building, 20,184,342,464, 635

Tackaberry, P. H., portrait of..... 243

Taxation as a means of redressing inequalities in the distribution of wealth, 169, 177

Ticknor, George L. (improving the earnings of country banks) 338

Trade relations of Canada and U. S....9, 163

Trust company powers for national banks sustained by Supreme Court..6, 173

Twitchell, Herbert K., portrait of....310, 818

United States trade relations with Canada9, 163

Uniting all the banks through the Federal Reserve System..... 764

War, America's entry into.....616

War and the New America—the new Pan-America 621

War credits, English 605

War, taxation and bond issues..... 486

Way to peace 3

Wealth, distribution and taxation of.169, 177

Wilson, George (Canada's financial and commercial relations with U. S.)..... 9

Winning the war455, 753

Women, banking and business training for 212

Women depositors24, 187

Working out our problem..... 755

II BANKING AND COMMERCIAL LAW.

Acceptance, powers of, by cashier..... 775

Acceptance by telegram—binding.....33, 35

Attest—three directors 191

Bailee of special deposits, failure to deliver will 470

Bank, liability for conversion of funds, 367, 783

Bank employees, woful ignorance of.... 773

Bankruptcy, uncollected funds..... 774

Book value of bank stock..... 41

Building and loan association, shareholder's rights 483

Check forged, paying bank liable..... 357

Check to fictitious person..... 363

Checks drawn against uncollected deposits 197

Checks sent direct for collection..... 33

Checks, travelers, indorsement forged.. 44

Clearing House rules 624

Conversion of funds.....367, 783

Collateral security lost, liability of bank collecting direct, liability of bank.....33, 34

Collection, due diligence not used.....33, 291

Collection, money remitted before recovery 197

Constitutional right to make a fool of one's self 356

Contract void, secured by fraud.....469, 476

Conversion of funds, liability of bank.367, 783

Corporate stock—book value..... 44

Corporation note, officer's authority to sign 623

Deposits, agreement in pass book..... 774

Directors, liability of, in false reports by cashier 192

Draft acceptance—powers of cashier.... 775

Effect of the war on shipping contract.. 356

Errors made by bank clerks..... 773

Federal Reserve Act—national banks as trustees 629

Forged check, bank paying, liable..... 357

Forged indorsement on traveler's check —liability of bank issuing same..... 44

Fraud—bona fide purchaser—stolen instrument 781

Fraud in procuring signature to promissory note467, 476

Industrial banking, Morris plan of..... 356

Kronprinzessen Cecile—broken contract. 356

Liquidation—payment of checks..... 197

Lost pass book, bond indemnity..... 781

Money had and received, liability of bank 367

Money paid under mistake of fact..... 39

Morris plan of industrial banking..... 356

National bank as bailee of will..... 470

National banks as trustees under Federal Reserve Act 629

Negligence of messenger..... 38

Note, corporation, officer's authority to sign 623

Note, demand, indorser discharged after fourteen months 195

Note, indorser discharged—negligence of presentment38, 201

Note obtained by fraud.....469, 476

Note, presented for payment to unauthorized agent 201

Overdrafts—when bank is liable..... 470

Pass book, agreement in, for uncollected funds	774	Citizens Trust Co. vs. Abston Wynne & Co.	775
Pass book lost, bond indemnity.....	781	Cohen vs. Chelsea Exchange Bank.....	35
Payment through clearing house.....	624	Colonial Fur Ranching Co. vs. First National Bank of Boston.....	623
Presentment for payment, negligence of messenger	33, 38	Elhard vs. Rott	44
Presentment for payment to an unauthorized agent	201	Ensign et al vs. Clark Bros. Cutlery Co.	35
Presentment for payment—unreasonable delay	195	Farmers' National Bank of Beaver Falls vs. Nelson	626
Reasonable time for demand note.....	195	First National Bank of Bay City vs. Grant Fellows, et al.	629
Replies to law and banking questions..	784	First National Bank of Philadelphia vs. National Park Bank of New York....	624
Sending collections direct.....	33, 34	First National Bank of Pukwana vs. Brule National Bank of Chamberlain..	357
Shareholder's rights in building and loan associations	483	Jarmulowsky, H. & L., in re.....	774
Special deposit, conversion of funds..	367, 783	Jones et al vs. People's Bank Co.....	363
Special deposit powers of national banks	470	Monk vs. Twenty-Third Ward Bank et al.	781
Stolen instrument—bona fide purchaser...	781	Myers vs. Exchange National Bank, Spokane, Wash.	470
Subrogation	39	Pittsburgh-Westmoreland Coal Co. vs. Kerr	39
Telegraphic acceptance binding	33, 35	Plymouth County Trust Co. vs. Scanlon.	195
Traveler's checks, indorsement forged..	44	Poole, in re	201
Trustees under Federal Reserve Act....	629	Saylor vs. State Bank of Allen, Kansas..	479
Ultra vires consideration in overdrafts.	479	Standard Trust Co. of N. Y. et al vs. Commercial Bank et al.	197
Uncollected deposits, checks drawn against	197	Stevens vs. Pearson	476
Uncollected funds, agreement in pass book	774	Sullivan vs. Knauth et al.	44
Valuation of bank stock.....	44	Wallis vs. Eagle Savings and Loan Association, N. Y.	483
Woful ignorance of bank employees....	773	Wingfield vs. Security National Bank of Sioux Falls	34
		Ziegenhagen vs. Suring State Bank....	783

LIST OF CASES

Ballard vs. First National Bank of Bollivar	367
Chesbrough vs. Woodworth.....	192

III. BANKING MISCELLANY, REPORTS, ETC.

Advantage of the bank advice of credit.	704	Banks:	
Alken, Alfred L., portrait of.....	753	Aall & Co. of Tokyo	246
American Bankers Association, annual convention, Atlantic City, September 24-29, 1917	313, 411, 563	American Steel Export Co.....	271
American capital in Italy.....	69	Astor Trust Office of the Bankers Trust Co.	93
American capital in Rand Gold mines..	662	Banca Italiana di Sconto	245
American Foreign Banking Association.	591	Bank of Adelaide	246
American International trade and finance	643	Bank of British West Africa	249
American Steel Export Co.	271	Bank of Japan	393
American Steel Export Co., portraits of officers	270	Bank of Montreal	813
Aspden, Thomas F., portrait of.....	593	Bank of Taiwan	247
Australasian banking conditions.....	561	Bankers Trust Co.	93
Avery, W. G., portrait of.....	291	Brown Brothers & Co.	85
Bank advertising exchange ..9, 409, 681.	816	Central Bank and Trust Co., Asheville, N. C.	119
Bank and the farmer.....	51	Commercial Bank of Italy	241
Bank reserves—Federal Reserve Act....	167	Commercial Banking Co. of Sydney, Ltd.	246
Bank training in Wall Street for women	193	Escanaba National Bank, Mich.....	416
Banking, international	61	Fidelity Trust Co., Portland, Me.....	697
Banking and financial history.....	685	First National Bank, Berkeley, Cal... 113	
Banking and financial industry.		Guaranty Trust Co. of N. Y.....	76
83, 259, 415, 511, 685, 811		Industrial and Commercial Bank, Ltd., Hong Kong	74
Banking and financial notes.		Industrial Trust Co., Providence....	103
125, 281, 421, 526, 733			

THE BANKERS MAGAZINE

vii

Italian Commercial Bank	77	Farmer and business methods	51
London Bank of Australia, Ltd.	244	Federal Reserve System	683
Mitsui Bank, Ltd., Tokyo	246	Ferguson, Samuel, portrait of	254, 824
National Bank of Commerce, N. Y....	261	Fidelity Trust Co., portraits of officials	699
National Bank of South Africa, Ltd..	512	Financial relations between English-	
National Shawmut Bank	814	speaking countries	663
New York Agency of the Bank of Tai-		Finger printing	557
wan, Ltd.	247	Foreign exchange facilities in Venezuela	246
Philippine National Bank	251	Forty-third annual convention, American	
Royal Bank of Australia	664	Bankers Association	563
Russian and English Bank	662	Gilpin, W. J., portrait of	136
Scandinavian Trust Co.	87	Goebel, P. W., portrait of	575
Union Bank of Canada	97	Grace, Eugene G., portrait of	707
Barrand, H. P., portrait of	142	Grant John M., portrait of	508
Bechter, Allen L. (thrift day; a patri-		Grant, R. P., portrait of	126
otic duty)	49	Greenebaum, Ellas, portrait of	131
Bechter, Allen L., portrait of	49	Harris, Hayden B., portrait of	692
Bethlehem Steel Company, a résumé...	707	Hinsch, C. A., portrait of	563, 705
Blair, F. W., portrait of	571	How bankers are doing their bit	
Bolinger, John, portrait of	688	12, 216, 310, 371, 671, 785	
Book reviews	53, 405, 494, 679, 839	Hutchins, R. C., Jr., portrait of	142
Brown, C. W., portrait of	120	Ichinomiya, R., portrait of	506
Brown, H. M., portrait of	103	Identigraphs, the	557
Business and finance in Chile	390	Imanishi, K. I. (concerted action sug-	
Business enterprises in relation to the		gested)	659
war situation	57	Imanishi, K. I., portrait of	249, 609
Butler, Nicholas Murray (search for a		Industrial service department for banks	719
new world)	589	International banking and finance ...	61, 231
Butler, Nicholas Murray, portrait of...	583	Items for which vouchers are missing..	738
Canada's system of paying oversea		Japan and the United States	670
troops	407	Japanese commission to America	408
Chase, C. H., portrait of	846	Johnson, A. F., portrait of	140
Chesterman, Bertram, portrait of	150	Johnston, Percy W., portrait of	819
Chile, business and finance	390	Jones, Raymond E., portrait of	284
Chosen, Korea, description and banking		Kains, Archibald, portrait of	692
system	65, 75	King, Richard L., portrait of	846
Clare-Avery, E. B., portrait of	724	Kinsey, Henry R., portrait of	820
Clarke, J. I., portrait of	139	Laird, J. P., portrait of	145
Cleverly, W. K., portrait of	137	Larned, W. L. (observations of a coun-	
Closer financial relations between Eng-		try banker)	490
lish-speaking countries	668	Latin American trade	79
Colt, S. P., portrait of	103	Law, William A., portrait of	667
Conant, Frederick O., portrait of	697	Lee, Frederic E., portrait of	128
Concerted action suggested	569	Letters of credit—standard forms	271
Courtesy, seven principles of	677	Lonsdale, John G., portrait of	303
Cowen, W. B., portrait of	847	Lynch, J. K., portrait of	440
Craig, L. W., (advantage of the bank		McGarrah, Gates W., portrait of	282, 728
advice of credit)	704	McHugh, John, portrait of	567
Credit, letters of, a plea for standard-		Maddox, R. F., portrait of	565
forms	271	Miller, B. S., portrait of	140
Criscuolo, Luigi (opportunities in Italy		Morgan, J. J., portrait of	562
for American capital)	69	National Bank of South Africa, Ltd....	512
Dadson, B. I., portrait of	536	National bank resources	55
Day, W. A., portrait of	441	National Shawmut Bank in the foreign	
Dean, Rodney (emancipated Russia)...	61	field	687
DeVausney, L. N., portrait of	137	Naylor, A. W., portrait of	112
Donovan, H. W., portrait of	126	New building for Brown Brothers & Co.	85
Easy and positive means of identifying		New foreign and domestic bank in New	
signatures	557	York	87
Eckhardt, H. M. P. (Canada's system of		New Pan-America	621
paying oversea troops)	407	Northcliffe, Lord, portrait of	581
Economic Chosen	65, 75	Northern New England's largest bank..	697
Escanaba National Bank, portrait of		Observations of a country banker.....	790
officers	416	Opportunities in Italy for American cap-	
Export trade, letters of credit of	271	ital	69

Orr, J. E., portrait of	536	Strong banking combination in Berkeley, Cal.	113
Ostrom, A. V., portrait of	90	Tate, E. P., portrait of	533
Parsons, George K., (industrial service department for banks)	719	Thanksgiving proclamation	752
Payment of soldiers	407	Thrift day; a patriotic duty	49
Phillips, Guy C., portrait of	844	Utility of letters of credit in the export trade	271
Pierson, L. E., portrait of	125	Venezuela, foreign exchange in	216
President asks state banks and trust companies to join Federal Reserve System	683	Vincent, W. D., portrait of	567
Record check—largest ever drawn	285	War and the Japanese	490, 669
Resources of national banks	55	War Situation in its relation to business enterprises	57
Reynolds, George M., portrait of	579	Wayne, Joseph, portrait of	569
Robinson, Charles C., portrait of	824	Weary, E. W. (war situation in its relation to business enterprises)	57
Sands, O. J., portrait of	569	What one bank has done to help the farmer	51
Schwab, Charles M., portrait of	707	Willis, H. Parker, (Philippine National Bank)	251
Search for a new world	689	Willis, H. Parker, portrait of	252
Seven principles of courtesy	677	Wilson, George (closer financial relations between English-speaking countries)	698
Sherer, William, portrait of	136	Wilson, George, portrait of	98, 669
Shipbuilding	707	Wilson, Woodrow, portrait of	683
Short, F. T., portrait of	98	Wolfe, O. Howard, portrait of	834
Sisson, F. H., portrait of	143		
Smith, G. F., portrait of	138		
Spencer, Florence, portrait of	541		
Staley, F. H., portrait of	818		
Statue of Hamilton at Washington.....	4, 58		
Steel industry	707		

The six monthly numbers are distributed throughout the volume as follows:

1-162	July
163-310	August
311-450	September
451-598	October
599-752	November
753-848	December

BOUND VOLUMES OF THE BANKERS MAGAZINE

Beginning with July, 1895, the volumes of The Bankers Magazine comprise the numbers for six months. Price, bound in cloth with leather backs and corners, \$4 per volume, by mail or express prepaid 40 cents additional.



HARVEY D. GIBSON

President, Liberty National Bank, New York

Mr. Gibson is a native of North Conway, New Hampshire, and a graduate of Bowdoin College in the class of 1902. He was first employed by the American Express Company in Boston and then in New York. Later with several business associates he obtained control of Raymond & Whitecomb Company, of which organization he became vice-president. When Seward Prosser, now president of the Bankers Trust Company, was made president of the Liberty National Bank some four years ago he invited Mr. Gibson to accompany him as assistant to the president. When on January 1 last Thomas Cochran became a partner in the firm of J. P. Morgan & Company, Mr. Gibson succeeded him as president of the Liberty National Bank.

THE BANKERS MAGAZINE

ELMER H. YOUNGMAN, Editor

SEVENTY-FIRST YEAR

JULY 1917

VOLUME XCV. NO. 1

Success of the Liberty Loan

EVERYBODY rejoices in the fact that the Liberty Loan was a complete success. It must hearten those who are fighting with us to receive this tangible proof of the enlistment of our financial resources in the great cause of democracy. We can be depended upon for the required amount of money needed to bring the conflict to a successful termination.

It is, of course, gratifying that so many of our people have participated in this loan, for this shows the popular character of the war. That the loan was more than subscribed is also the source of great satisfaction.

The Liberty Loan Campaign was a novelty to the present generation of Americans, who had never seen anything like it. Their interest and enthusiasm were enlisted from the start in a way that rendered the success of the loan certain. The coöperation of the banks in carrying on the campaign did much in securing the magnificent result. Secretary McAdoo also did effective and brilliant work.

When other loans come to be placed next autumn, the experience gained in this whirlwind campaign should be of much service. The people have been aroused to the desirability of buying Government bonds, and their appetites once whetted, they may be expected next time to require less coaxing. Furthermore, the education furnished in this campaign must ultimately be of value in creating in this country a body of trained investors who will readily absorb Government bonds and other good securities.

Bankers in common with all other citizens are proud of the success of the Liberty Loan of 1917.

CHEMICAL BANK'S CHANGE OF POLICY

THE change of policy recently made by the Chemical National Bank of New York in regard to the payment of interest on deposits was an event of unusual interest. This bank announced that after almost a century of non-interest paying policy it had decided to pay interest on bank balances, time deposits and special and reserve accounts.

No bank in the United States has borne a higher reputation than the Chemical. "As good as the Chemical Bank" meant much the same thing here that the expression "As good as the Bank of England" meant in Great Britain. This notwithstanding the fact that the Chemical rather slyly entered the country's banking system!

Doubtless the considerations which led to this important departure were of a purely practical nature. The bank found that under present conditions the change was a wise one, and that the maintenance of the century-old policy would not be conservative, but the reverse.

There has been criticism, and not without reason, of banks that show an ambition to pile up big deposit totals. But, on the other hand, in these times of rapid business expansion, a bank lacking magnitude is sometimes hampered in rendering adequate service. So far as New York is concerned, the day of the small bank is gone by, unless a purely neighborhood business is to be transacted. Of course, a bank with the reputation of the Chemical would not be making adequate use of its prestige if its business were localized. And to keep in position to extend its operations, especially in times like these, provision for expansion must be made. In other words, a bank is not merely a collection of precepts, but a living organism and as such must fulfill the law of growth and of life. This is the fact recognized by the directors of the Chemical National Bank in altering their century-old rule about paying interest on deposits.

As an abstract principle, the payment of interest is not looked on with favor by many bankers. Undoubtedly, where the interest rate is high, the practice tends toward unsound banking, for a bank that is paying a high rate must get a still higher rate for its loans, and this tends to the making of loans that are not of prime character. But, of course, the well managed bank does not pay a rate of interest on deposits great enough to incur this danger.

The banker's ideal, where a willing world will freely pour money into his coffers which he may lend out at a good round rate, is yet far from realization. The Federal Reserve Bank can get deposits

without offering any interest, but the bulk of these deposits come by compulsion of law rather than as a free offering.

Interest is a magnet which a bank employs to draw into its tills the unemployed money of the community. Given two banks that are equally well managed and affording the same degree of service, and one paying interest on deposits while the other does not, it is clear enough which bank will get the most deposits.

It is a general practice for the banks of this country to pay interest on certain classes of deposits. Any bank wishing to maintain a satisfactory rate of growth must conform to this practice. The directors of the Chemical Bank have recognized this fact. Had they failed to do so they would have handicapped their institution as an efficient servant of the business community.

In deciding to pay interest on deposits, the Chemical National Bank, under all the circumstances, has acted wisely, fully maintaining the spirit of sound conservatism which has been its own just pride and that of American banking in general.

THE WAY TO PEACE

PRIOR to the sixth of last April the Imperial German Government had the opportunity of keeping on a peaceful basis with the United States, sorely as our patience had been tried by the series of outrages of which that Government had been guilty. We only asked a disavowal and reparation for the most heinous of these acts and reasonable assurance that they would not be repeated. This request Germany refused and continued its policy of sinking our ships without warning. Then we declared war. There was no other way, as President Wilson so impressively said.

Now that we are in the war there is one main problem to consider—to bring our enemy to a state of mind where he will accede to the peace terms which will satisfy this Government and the nations with whom we are now in virtual alliance.

The way to this peace—and the only way—is through the stern pathway of war. And to this conclusion must all of us come who have not already reached it.

The time for discussion of what might have been, and for diplomatic exchanges, has gone by. We are now face to face with the stern realities of war, and these must be met in the manful way which the world rightfully expects of free America. This may call for the gravest sacrifice, not for those only who contend against the

foe on the sea or on the field of battle, but reaching to every home in the land.

It is our business now to win the war, and to that end the national resolution and the national strength must be firmly committed. As we have put our hands to the plow, there shall be no turning back till the end of the furrow is reached.

We shall have to put forth, as rapidly as practicable, such military and naval exertions as will help in bringing the war to an end, and no matter how hard and long the struggle, or what it may cost in money and lives, there must be neither variableness nor shadow of turning upon our part until the Imperial German Government sues for peace.

Now is our opportunity to make plain to Germany and to the world that we do not lightly enter upon war, but that having done so we do not make peace until we win what we are fighting for.

The way to peace, and the only way, is by victory over our enemies.

HAMILTON TO HAVE A STATUE AT WASHINGTON

MORE than a century after his death Alexander Hamilton is to have a statue erected in his honor at Washington. The monument will appropriately be located on the Treasury Plaza.

It seems proof of the ungratefulness of republics that this tribute has been so long delayed. Next to Washington and Jefferson, Hamilton did more than any other man to establish this nation upon its present firm foundations. Many would be disposed, indeed, to rank Hamilton before Jefferson; but it must be remembered that Jefferson's greatest work was antecedent to that of Hamilton, and without it the latter would have had little opportunity for his wonderful display of constructive statesmanship.

Although Hamilton has been lauded for his financial genius more than for anything else, he was primarily distinguished for his advocacy of a strong centralized government, and it is very largely due to his exertions that the Union of the States was established with a firmness which thus far has rendered dissolution impossible. That the disintegrating forces which of late have produced such unsteadiness in Russia and China have failed of repetition here may be attributed largely to the fact that Hamilton perceived the danger of a Union of States with inadequate Federal powers and took

adequate means of guarding against it. Hamilton, besides being the creator of a strong central government, virtually established the National Credit. For the assumption of the state debts by the Federal Government he paid a large price—the transfer of the capital to Philadelphia and ultimately to Washington. In the early days of the country's history this was not a matter of much importance, and doubtless Hamilton looked upon it as a contention for social prominence, and possibly as having more or less advantage from a real estate standpoint. Nevertheless, it has now become a matter of very great importance. In London, Paris and Berlin, as well as in most of the great political capitals of the world, legislation is profoundly influenced by public opinion at these great centres. In Washington such opinion simply does not exist. It is an open question as to how this has controlled public policy toward business. Certainly, in the main, this policy has been hostile. To save the credit of the infant republic was to Hamilton a matter of supreme concern. But if he could have foreseen the effect upon public affairs of the transfer of the capital of the nation to a point lacking in public opinion of a positive character, might he not have hesitated in exchanging capital location for debt assumption? The question at least is an interesting one from the standpoint of intellectual speculation though not of much practical importance, for the capital is firmly fixed on the Potomac marshes and the legislation of the country destined indefinitely to be shaped from the parochial viewpoint.

Honors to Hamilton are well bestowed, for he was one of the really great men this country has produced—one whose fame grows with the lapse of time.

DEVELOPMENT OF AMERICAN BANKING

ONE of the recent notable developments of American banking consists in an increased relation to banking operations in other countries. This alteration has come upon the country rather suddenly, and found the American bankers not well prepared for it. True enough, we have begun a cautious expansion of our banking into other countries, but we have hardly realized as yet the extent to which foreign banks have come to depend upon New York as a money centre and the vast and hurried movement of banks all over the world to come into closer touch with our chief money market. American banking has been for a long time intensely local, and it will require some years to break with past practices and tradi-

tions. But this must be done if the country is to assume the financial leadership which the exigencies of the situation demand.

Just now financial and diplomatic pilgrimages are making their way to New York and Washington from various quarters of the earth. Great Britain has provided for permanent representation here, while a special mission is on its way from Japan, and Russian and Italian missions are already here.

The freedom which the banks would have in conferring with these respective missions in ordinary times is somewhat restricted by the policy of the Government to insist on a concerted programme of financing the foreign requirements, and thus conserving the moneyed resources of the country for use to the best advantage.

While a few of the larger banks in New York and the other leading money centres are accustomed to handling foreign financial problems of magnitude, the situation is new and strange to the majority of the American banks. They are quickly adapting themselves to the changed conditions, however, and it may be expected that in the near future they will creditably meet the extraordinary demands made upon them.

TRUST COMPANY PROVISION OF FEDERAL RESERVE ACT SUSTAINED

FOR the first time since the enactment of the Federal Reserve Law in 1913 that measure has come before the Supreme Court of the United States. The point litigated in this instance related to the constitutionality of the provision of the law conferring trust company powers on national banks, the Supreme Court sustaining this portion of the law.

The matter for adjudication came before the court from the State of Michigan. It will be remembered that the Supreme Court of that state and also of Illinois had held that this provision of the law was unconstitutional.

The reasons for conferring trust company powers on national banks have been frequently stated. Briefly, the trust company banks could practically do all kinds of banking, including many functions denied to national banks, and if the latter were to hold their own in competition with the trust companies, their powers must be enlarged. The struggle to bring about this change has been going on for a good many years. The Federal Reserve Act gave legislative recognition of the right of national banks to do a trust

company business, and this legislation has now been sustained by the highest judicial tribunal in the land.

FUTURE RESPONSIBILITIES OF AMERICAN BANKING

BEFORE long the banks of the United States must assume responsibilities to which they have heretofore been strangers.

These new responsibilities relate to the financing of foreign enterprise. To provide the banking facilities required for the ordinary foreign trade is a comparatively easy matter, because imports and exports give rise to bills of a more or less liquid character calling for the temporary lock-up of a small amount of capital. In domestic trade the banking documents arising out of the progress of commodities from the producer to the consumer are of prime character, and the same is true of those arising from foreign trade, although in some cases the element of time enters more largely into the latter than the former.

But when we come to the great constructive enterprises of a country—the railways, shipyards and docks, the mines and industrial plants—different problems are encountered. It may be said that the financing of such undertakings lies outside the domain of commercial banking and that it is therefore not properly the concern of American bankers. The first part of this statement is true, but the latter part is not. While an ordinary commercial bank may not properly engage in financing of this character, the bankers of the United States are nevertheless deeply and vitally concerned in it. Indeed, if our own great manufacturing plants are to have a steady outlet for their products, and if our labor is constantly to be employed at good wages, it is necessary that we should provide in the near future for taking a large share in the financing of foreign enterprise. This may be done through the great investment banking-houses now in existence, or it may call for a new and special organization. Doubtless as a preliminary to our entrance into this new department of American banking, the ordinary commercial banks which have branches in foreign lands will map out the field, study existing conditions, and report upon the prospects. Fortunately, a good deal of this advance scouting is now being done.

The amount of capital required for investment in the near future in development work of the character under consideration will be large. Ravages made by the war must be repaired, and the halt

in the development of enterprise occasioned by the great conflict, in lands not immediately affected, must also be overcome.

Assuming that the necessary machinery exists or will be provided for carrying on this important work, there yet remain other problems of serious moment. Shall we have enough capital to go around, and will the American people buy the securities representing investments in foreign lands?

That the world will be capital hungry after the war is clear enough, but it is by no means certain that we shall be able to appease that hunger. Our store of capital, now very large, may be depleted before the great struggle ends. We shall need to save more than ever before, both to meet our own needs and those of others. But the competition for capital, which will be world-wide, should offer an excellent return on investments carefully made abroad.

Another matter that relates closely to the investment of American capital abroad is the future of the market here for foreign securities. Heretofore these securities have been almost total strangers to our exchanges, and even now only a few Government bonds are listed. The great railway, mining and industrial stocks and bonds are as yet practically without representation in the list of securities dealt in on the New York Stock Exchange.

This condition cannot continue if New York is to assume a position of real importance as an international money centre, for one of the prime requisites of this distinction consists in the furnishing of a liquid market for high-grade securities representing investments in the world's chief commercial countries.

In the obtaining of this essential we have not as yet taken the first step. Shall we wait until the war is ended before giving consideration to this most important matter? Ought not action be taken with as little delay as the magnitude of the problem demands toward better equipping New York to meet its duties as an international money centre?



Canada's Financial and Commercial Relations With the United States

By GEO. WILSON, Agent, Union Bank of Canada, New York

[In this paper Mr. Wilson has called attention in a striking way to the highly important trade and financial relations existing between Canada and the United States—relations which are destined to grow still closer in the years to come, based upon a thorough understanding of the mutual advantages to the people of both countries.—EDITOR BANKERS MAGAZINE.]

IT is common knowledge that important trade relations exist between the United States and Canada, but it is doubtful if the average business man of either country is aware of the magnitude of the business transacted between the two nations. A casual examination of the following figures will emphasize this fact.

TRADE OF CANADA—TWELVE MONTHS ENDED JUNE—IN MILLIONS OF DOLLARS

		1913	U. S.	U. S.
Merchandise	Total			
Exports	385	153	39%	
Imports	684	443	64%	
Total Trade....	1,069	596	56%	
Excess Imports...	299	290		
		1914	U. S.	U. S.
Merchandise	Total			
Exports	449	182	40%	
Imports	579	368	63%	
Total Trade....	1,028	550	53%	
Excess Imports...	130	186		
		1915	U. S.	U. S.
Merchandise	Total			
Exports	502	185	36%	
Imports	426	284	66%	
Total Trade....	928	469	50%	
Excess Imports...	...	99		
Excess Exports...	76	...		
		1916	U. S.	U. S.
Merchandise	Total			
Exports	970	300	30%	
Imports	596	442	74%	
Total Trade....	1,566	742	47%	
Excess Imports...	...	142		
Excess Exports...	374	...		

TWELVE MONTHS TO MARCH, 1917

Merchandise	Total	U. S.	U. S.
Exports	1,151	280	24.37%
Imports	845	664	78.57%
Total Trade....	1,996	944	47.31%
Excess Imports...	...	383	
Excess Exports...	306	...	

The main impressions resulting from an analysis of Canadian trade statistics are, firstly, the amazing conversion of an unfavorable trade balance of \$130,000,000 for the year to June, 1914, to a favorable trade balance of \$306,000,000 for the year to March, 1917, and, secondly, the enormous proportion of the total Canadian trade credited to the United States. A reversal of trade form of over \$430,000,000 in three years is an achievement only rendered possible by a beneficent Providence which blessed the country with bountiful crops—particularly in 1915—by an automatic stoppage of national capital expenditures when war was declared, by heavy orders for munitions and war supplies placed by the Motherland and her Allies and lastly, and probably leastly, by the retrenchment of personal expenditures.

For some years past Canada's purchases from the United States averaged \$2.50 worth of goods for every \$1 worth sold to the United States, indicating that Canada has always been one of Uncle Sam's best customers. The traditions of both peoples, geographical proximity and similarity of business methods all conduced to active trade re-

lations, and as the volume of commercial business between the two nations developed a corresponding expansion in the purchase of Canadian securities by American investors followed as a natural sequence. Prior to the war Canada's financial requirements were largely supplied by London, borrowings in that market for several years averaging \$250,000,000 annually, whereas the amount borrowed in the United States was comparatively a negligible quantity. For instance, in 1912 Canada's total borrowings were approximately \$275,000,000, of which \$204,000,000 (seventy-five per cent.) was secured in Great Britain and \$31,000,000 (about eleven per cent.) in the United States. After August, 1914, the golden stream of capital from London practically ceased to flow, but Canada quickly found an affluent friendly neighbor, who was not only ready, but willing to show a financial neutrality, as the following figures graphically attest:

CANADIAN BORROWINGS IN THE UNITED STATES AND PER CENT. TO TOTAL BORROWING

1914	\$54,000,000	19.77%
1915	144,000,000	42.11%
1916	206,000,000	65%

It is true that approximately \$45,000,000 of Canadian Government Municipal and other securities matured and were refunded in 1915 and 1916 by borrowings in the United States, but even allowing for such deductions, Canada obtained \$300,000,000 of *new money* there during the two years referred to.

Notwithstanding the colossal flotation of \$5,000,000,000 of American War Loans this year, it is not improbable that Canada's borrowings in the United States during 1917 will equal, if not exceed, the total for 1916.

Canada's internal finance with the outbreak of war was not entirely immune from the contagion of universal financial and commercial paralysis, but possessed of a healthy constitution, a valiant spirit and a bulging bank roll, the remedies so quickly prescribed and applied by that eminent financial

specialist, Sir Thomas White, backed up by numerous consulting financial experts, rendered the attack very mild and innocuous. The promptitude, efficiency and courage exhibited by the Canadian Finance Minister in grappling with the unprecedentedly difficult and dangerous problem, aroused general confidence and quickly allayed all evidences of nervousness throughout the country. The notable success attending the flotation of three national war loans totalling \$350,000,000 during the past thirty months proves conclusively that the country's confidence was not misplaced.

To assist in the purchase of munitions Canada has advanced \$370,000,000 to the Imperial Government; \$170,000,000 of this amount having been supplied by the Canadian banks and \$200,000,000 by the Dominion Government.

There are upwards of six hundred concerns in Canada manufacturing munitions employing 275,000 people, of which a large proportion are women, and contracts for munitions and war supplies have already been placed in Canada to the extent of \$1,200,000,000.

This abnormal industrial activity has created a condition of prosperity which is strongly reflected in the enormous increase in bank deposits since August, 1914. At that date the total was \$1,137,000,000 and in April, 1917, \$1,650,000,000.

For a few months immediately following the outbreak of war, the most drastic economy and retrenchment was practiced by all classes, but with the restoration of confidence and the placing of large war orders, the old habits of extravagance and wastage were again soon in evidence. Wages increased and money was plentiful everywhere. The purchasing power of the common people was larger than ever before and was exercised most prodigally, few seeming to realize that the universal prosperity was artificial and ephemeral and that with the cessation of hostilities the pinch would come. The United States is confronted with precisely the same conditions and too much stress cannot be laid upon the necessity for assiduously educating the people of

both countries to "cease wasting their substance in riotous living" and to lay treasure aside for the rainy day which is bound to come.

The United States Government has with commendable promptitude set itself to the task of organizing and controlling the food and industrial output of the country, and is apparently determined to avoid the pitfalls of waste, which have caused such unnecessary depletion in the resources of its Allies during the past three years. The mobilization of the housewives of the country on the principle that conservation begins at home is but one of the numerous examples of efficient organization which might be adopted in Canada to advantage.

Dogmatic predictions of conditions immediately following the declaration of peace would probably prove as far astray as those which were made following the declaration of war, but after bridging the hiatus oft quoted as the "period of reconstruction," all signs point to an extended period of great industrial activity in this Western Hemisphere. The United States with its unbounded wealth of raw materials, its highly specialized manufacturing ability and its thoroughly organized industrial forces will be the world's chief factor in restoring the devastated areas of Europe. Canada has during the past thirty months been put to the test in a manufacturing sense, and has not been found wanting. Splendidly equipped manufacturing plants have been established in every Province, and the army of skilled workmen trained in the manufacture of the delicate and devilish implements of war will be turned to good account in supplying the implements of peace.

No country offers greater possibilities as a food producer than Canada. The Prairie Provinces of Manitoba, Alberta

and Saskatchewan contain about 270,000,000 acres of arable lands, of which about 21,000,000 acres (less than eight per cent.) are under cultivation. With a population of 1,870,000 these three Provinces produced in 1916 cereal and root crops to the value of approximately \$500,000,000 or a per capita production of \$264, the magnitude of which may be judged by a comparison with the per capita production of the United States, which in 1916 was \$73.46. In the ratio of last year's production, given a population of less than 25,000,000, the three Western Canadian Provinces would possess a productive capacity of cereals and roots to the value of \$6,432,000,000

Elaborate land settlement schemes on a national scale and a selective immigration policy have already been promulgated by the Dominion Government, backed by the energetic coöperation of the Provincial authorities. The Canadian Pacific Railway, which owns millions of fertile acres in the West, has decided to entirely discontinue the sale of land to speculators, and to encourage actual settlers by providing ready made farms, including house, fences and cattle on a twenty-year installment plan. Can it be doubted that the war-worn people of Europe will flock to Canada's golden west after the terrible conflict is over?

The Province of British Columbia, which has already attracted millions of American capitalists, offers unlimited opportunities for investment in the development of its mines, forests and fisheries. In short, Canada from East to West looks forward hopefully to an era of great agricultural and industrial expansion after the war and confidently expects that American man power and American money will contribute in full measure to the development.



How Bankers Are Doing Their Bit

If any one of the officers of your bank have joined the colors, if you are making special provision for your employees who enlist, if you have started a Garden Club or a Liberty Loan Club or are engaging in any unusual activity incidental to the war, we hope that you will write us about it.

Our idea is simply to record in the *MAGAZINE* what banks and bankers are doing in the war so that our readers may know about their contemporaries in every part of the country and incidentally receive suggestions and inspiration of how they themselves may help in the big task that confronts us.

"COME, MAN, AND BUY A BOND"

One of the most unique and effective appeals for subscriptions to the Liberty Loan that has yet been made comes from the pen of Horace W. Dresser, secretary of the City Trust Company of Buffalo. The appeal has been so greatly appreciated that the Buffalo General Committee of the Liberty Loan has had 30,000 copies printed for general distribution. Mr. Dresser's appeal is called, "Come, Man, Buy a Bond," and is as follows:

"Enlist your heart and soul in this great cause. One of your friends has enlisted his heart and soul—and body, too. He's mustered in. He starts for France to-morrow. His sacrifice is real. Your buying this bond is no sacrifice. You are buying something it is good for you to have. You are getting value. You gave to the Red Cross; you subscribed for the starving Belgians. Both acts were worthy. But, man, here's the most important thing of all—and it doesn't cost you anything. It's a good investment—the best in all the world. And it's going to help Jim who starts for France to-morrow, who has offered his life to your country. That bond may help to save Jim's life and bring him back to Mrs. Jim and the kiddies.

"Won't you feel better, inside, to-morrow, when you meet Mrs. Jim on the street, if you buy that bond to-day?"

"You weren't there when Jim said 'Goodby.' Little Jim and Janet were clinging to his knees; Mrs. Jim looked up at her Big Boy and smiled, dry-eyed. Yes, smiled, and hardly a quiver to her

lips. And Jim—he cut it short. He couldn't stand it long. And Mrs. Jim went back into that quiet house and put those little ones to bed—and now it's quieter than ever there, with Big Jim gone.

"Do you know where she is now? She has turned down the lights in her room—their room. She does not want anyone but God to see her. She is kneeling beside a bureau drawer, which Jim, when he packed up, left open, in his careless way. She is pressing to her heart a worn and homely thing. It is one of Jim's old shoes. She has not stirred for a long time.

"The shade in the window has not been drawn. She is gazing out on the rainy, wind-swept street. A military band is playing somewhere near. Not Jim's band. Jim has gone. But Jim had a band like this—"

"Gone! Gone!"

"To-morrow, the commonplace tasks of a woman's day; breakfast for little Jim and Janet; then getting them away to school. They are very little children. They don't realize. They will awake and laugh and eat a hearty breakfast and hurry to tell their small friends how proud they are of their big Daddy. The other children all will envy them. Envy them!"

"Will any grown-up be as big as they, and envy Mrs. Jim?"

"You will meet her on the street to-morrow. She will be clear-eyed then. Her lips will force a smile—and only those who know her will dream that it is forced.

"Come, man, and buy a bond; so that

when you met her, your eyes may hold no shade of self-reproach; so that your soul may not cry out 'I did not help to save him!' But rather, let it quietly exult, 'I'm going to save to help him.' Come, man, buy a bond."

TWO HUNDRED EMPLOYEES REGISTERED

On June 5, about two hundred employees of the National Bank of Commerce in New York registered in accordance with the President's proclamation.

The Commerce has eight militia men on active service and six employees are attending at the various officers' training camps.

The Commerce Club is formulating plans for keeping the bank in active touch with those of its staff who are called to the front.

M. AND M.'S MEN ENLIST

The Mechanics and Metals National Bank of New York reports eleven of its employees in the National Guard, one in the navy and one in the U. S. Coast Guard.

TURN CHRISTMAS CLUBS INTO LIBERTY LOAN CLUBS

The Bank of Southold, N. Y., has made arrangements whereby any holder of its Christmas Club cards may transfer the amount when due toward the purchase of Liberty Bonds.

TAKES UP THE PEN IF NOT THE SWORD

The following letter from L. F. Spencer, cashier of the First National Bank of Ridgewood, N. J., will prove interesting:

"Responding to your cordial invitation to report any unusual activities incidental to the war, engaged in by the officers of this bank, I regret to say that neither president nor cashier has "joined the colors," although of full age, one having been born in 1833 and the other in 1835; neither are we doing much garden work, but the writer worked pretty hard in grinding out the enclosed lines on Freedom, and hopes

the effort may be regarded as his "bit," although very small when compared with what he would like to do."

Mr. Spencer's poem appeared originally in the "Ridgewood News," and runs as follows:

FREEDOM HERE TO STAY

A throne was scorned by Washington
That freedom might be ours.
And Lincoln gave in measure full
His consecrated powers.

To strike the fetters from a race
That long in bondage sighed;
And seal the Union of our States
For which he nobly died.

Shall we of such proud heritage
Betray our sacred trust?
And let the flag they glorified
Be trampled in the dust?

That shall not be! No tyrant hand
Can forge for us a chain.
Should hostile hordes come o'er the seas,
We'll hurl them back again.

May God decree, that from our shores
Dear Freedom ne'er shall roam,
But make this land her place of rest,
Her everlasting home.

FRANKLIN SOCIETY DOES GOOD WORK

The officers and employees of the Franklin Society of New York immediately after our entry into the war were awake to the seriousness of the situation. They realized that much in the nature of service to the country would be required, and they set about the work cheerfully. Those employees who live in the suburbs have their own gardens, and the society itself as the owner of a considerable tract of vacant land offered it gratis for purposes of cultivation.

The society's latest effort and greatest success was in its campaign to sell Liberty Bonds. It did not attempt to compete with the national, state banks and trust companies, in the amount it intended to sell, but devoted itself to reaching the small people—the very ones among whom the government preferred to place the bonds. In denominations of \$50 and \$100 it sold \$200,000 par value of Liberty Bonds. Its subscribers number two thousand, and they are permitted to pay for their subscriptions any time in any manner suited to them before June 15, 1918. Of these subscribers at least sixty per cent. are people who never saved a cent in their lives.

The president made several addresses for the Liberty Loan Committee. The vice-president and manager is active in Red Cross work and a member of the finance committee of his home chapter. The secretary-treasurer, a former captain of the National Guard, has reported for duty at his old armory. Several of the young men did voluntary work in connection with the national registration, and are now doing work for the state registration. The young ladies are doing work for the Red Cross.

There isn't a man or woman in the institution who would not be willing to undertake any other work, if in the opinion of the Government that other work would be more important than the work now being done.

SUCCESSFUL WORK BY A COMMITTEE

President Chas. A. Spaulding of the Farmers National Bank of Allentown, N. J., formed a committee of fifteen representative men of the community, and by their personal work applications for \$110,000 of Liberty Bonds were received.

BOOMING THE LIBERTY LOAN

The Stafford (Conn.) Savings Bank has been booming the Liberty Loan issue energetically and has placed about \$45,000 among 700 people under the installment plan, to be paid for in weekly payments or monthly installments as will best accommodate the subscriber. The First National Bank has placed \$160,000 among about 325 subscribers, to be paid for under the plan proposed by the Government. A Liberty Loan Club was established, which helped very materially in getting subscribers.

A SUCCESSFUL LIBERTY LOAN CLUB

The First National Bank of Coopers-town placed subscriptions to the Liberty Loan amounting to \$282,350, the number of subscribers being 512.

A Liberty Loan Club was started by the bank May 9 and has at present a membership of 192. The club will be continued until July 10, and a new club started with each subsequent issue of bonds. The bank's purchase of bonds for its own account and for the club members amounted to \$40,000.

CHICAGO BANK PRESIDENT MADE LIEUTENANT COLONEL

Charles G. Dawes, president of the Central Trust Company, Chicago, has been commissioned lieutenant colonel of the Seventh Regiment, U. S. Reserve Engineers, with headquarters at Atlanta, Ga. The Seventh is one of nine regiments which will go to France to rebuild the lines destroyed in the war. Mr. Dawes' work in early life as a civil engineer before becoming comptroller of the currency and later a Chicago bank president qualify him for his new duties. It is expected that Mr. Dawes' financial abilities will be even more in demand than his engineering knowledge.

Vice-president Joseph E. Otis, it is understood, will handle the affairs of the Central Trust Company while President Dawes is serving his country in France. President Dawes' brothers, William R. Dawes and Henry M. Dawes, it is believed, will take his place in the management of his other interests.

CLEVELAND TRUST CO.'S CONTRIBUTION

Four employees of the Cleveland Trust Company are in training with the Officers' Reserve Corps at Fort Benjamin Harrison.



The Evolution of Business

(Continued from June Issue)

By E. J. NEWELL

BUSINESS, retail, wholesale, manufacturing, has been developed, organized to care for the highest point to which demand can be pushed. Plants are built, and machinery once in, costs so much it must be operated at full capacity to pay. It must be fully employed and the manufacturer forces his wares on the market all the time to make his business successful—he can not go backward. It is not supposed for a moment that all the magazines—we will say—of the present day are necessary. The public does not demand them all, but men know that magazines can be made to pay, they think they can do it, they go into the business, forcing down the sales of others, and some are successful, some are not. But the consumer is tempted to buy more than he needs, so there is continually a higher service to the individual, pushing him to a plane which can be easily disturbed.

There are two kinds of business trouble—a panic and a general depression. We have seen how interdependent people are, how one line of business supports another, how if a man is successful, he will spend in proportion. Suppose a representative of the United States Government should bring word to a man—that because he had on some occasion rendered a great service to the Government, Congress had voted him fifty thousand dollars a year as an annuity, with a rider in the resolution that it could not be revoked, but would be paid to him and his heirs as long as the Government stood. How would that affect the exercise of his purchasing power? He would spend that income. The reverse is the principal direct cause of disturbance. The fear of a man that his income will be curtailed.

If stirred by this fear he contracts his purchasing power, all dependent upon him and his former method of living will suffer. Along the same lines, the fear that the future may not be as bright, that conditions are not right, causes him to slacken his effort and curtails new enterprises. Those who go ahead and take the initiative are afraid, and the expansion necessary to keep up with the increase of population—the climbing upward in the scale of living—is checked and contraction is under way. It is hard then to get the exchange of business back to its former activity. In 1907 the story was told of a salesman representing a soap company in a western New York city who endeavored to sell soap to a company store at a coal mine in Pennsylvania. The manager of the store said they were running only half time and had on hand all the soap they needed. Upon being urged he said, "Look here, you buy our coal; I have seen your company's name on cars going out. If you will buy more coal, we will buy more soap to wash our hands." And the soap man answered, "I guess you are right, but who in blazes is going to start it?"

A panic is a state of mind brought on by the fear of something unfavorable to happen, or something has happened and more is expected. It follows over - production, over - development, speculation, when the forcing process has been too great, and the industrial fabric has become too sensitive. A financial and commercial panic come together. The feeling men have is like that which anticipates bodily harm. Men fear that they will lose not only their present purchasing power, but that which they have laid away. They hide actual money, they sacrifice their

investments to convert into money, they fear a general catastrophe, they realize they have been reckless, living too extravagantly, they curtail purchases and simplify their method of life.

Then there is an industrial depression caused by long-continued, unsettled conditions. Such a depression our country has just passed through. No settled policy to protect the business men is in sight. They all wait and hope—perhaps, until the pressure from behind compels those who are able, to take the initiative, to go ahead and manufacture for the future.

Anything that changes the regular order of things disturbs. There are some changes which in the end are for benefit and progress, such as the introduction of machinery against which at first men revolted. There are natural as well as artificial causes of disturbance, a change of weather or a late season locally will make great differences. There is the men's wear merchant with an extra stock of fleeced-lined underwear in a mild winter.

A manufacturer pushes his salesmen too hard. His traveling men sell their customers so much that they get no repeat orders, the goods remaining on the shelves. The manufacturer finds trade from his usual clients lessened and has to look for other buyers, displacing some one else. To create the market or get the buyers away from a competitor, he has to undersell or lessen the cost of manufacture, which stimulates invention, which forces something else out of joint, and so the merry-go-round goes on. An optimistic manufacturer, because of a big year, builds additions, putting his surplus, his profits, and perhaps borrowed money besides, into the new factory. Something aside from a depression may change conditions or styles or the manner of marketing goods in his line, and he is left high and dry with his money in bricks and mortar and machinery which he cannot use.

If any number of workmen are drawn to an industry that grows unusually fast, as the automobile business, there are unsettled conditions. A few years ago, it is said, perfect plate window

glass was difficult to obtain because all the best workmen in that line were being used for making windshields for autos, and it took two years to develop men to take their places. The change of styles in dress have far-reaching effect. These are common causes of disturbance. Some one has to stand a loss if any one pays more for a service or less for an article than it is worth.

Little tolerance should be shown to certain extreme doctrines of the present day that are so much in evidence. There should be a square deal for every one, including the business man. A large factor in this hysteria of the past few years is the presence in our country of so many who have perhaps been persecuted in other countries and who cannot see that America is different, that every man here has an opportunity—and there are those also who stir up trouble and class feeling because it gives them prestige and an easy living.

The incident is recorded that one of these haters of success referring to a man who was receiving twenty-five thousand dollars a year salary, said to a friend, "I do not believe any man can earn that amount or be worth it." And the friend answered, "Let me ask you a question: Supposing I should say to you, I know of a position at the head of a large concern employing four thousand men, which is open. The last man who had it was there six years, and then went abroad—to Carlsbad—to see if he could save what was left of his liver and kidneys, his nerves had long since gone. He is back home now and they give him a year to live. As you are in a fine physical condition and have ability, I think you ought to last about eight years. How much do you want per year while you stand it?" The critic looked at his friend a moment and then said, "Great Scott, I never thought of it in that way." People do not know the underlying conditions, and what seems not right and one-sided, when they come to know about it is entirely proper and fair.

The all-powerful law of supply and demand, losses in price and the failures brought about by a glut of poultry, ap-

ples, wheat, corn, meat or food of any kind, could be referred to, and also labor troubles, speculation, price wars, real estate booms and all the long line of disturbances, the reasons of high prices for commodities and labor; political, social, commercial, unrest, international complications, religious and economic influences, all of which bear on this subject. But enough has been stated to point clearly the reasons for continual change in the conditions of life.

In making deductions from this analysis, no sympathy is to be expressed with the efforts of many to give us a paternal government which will do everything for us. We have reached this high plane of life, we cannot go back. Our salvation is the field produced by more people continually bettering their style of living, supplying luxuries for physical and mental enjoyment, but always within reason and not with too rapid development. The old idea of American government and the liberty of individual achievement is a sound one. Man must be allowed to make legitimately and preserve his individuality and ambition, and not be condemned if he is successful by some demagogue who does it because he thinks it is a popular sentiment and will bring him prestige and votes. Men risk their money and reputation in starting a business. If they fail, no one sheds a tear except their relatives and creditors. If they make good, they should be allowed to make all the money they can, providing they do not hurt in any way those whom they serve. *Competition should be free*, and any one who does wrong should be punished, but men should be allowed to work out what their individuality allows them to, with whatever reward accompanying. In turn the successful man will distribute his purchasing power to a reasonable extent and save some for the low ebb of business tide sure to come from natural or artificial causes. If we interfere with individual development, we must go back to just providing clothing, food and shelter, pulling down all standards to simple necessities, and with

the present population there would not be one-tenth enough work to go around, and prices and wages would be at the lowest figure, with demoralization and misery untold—a return to primitive times.

We are creatures of habit. If we stay in evenings for a month, we do not want to go anywhere. If we go out somewhere every evening for a month, we cannot possibly stay home with content, and this characteristic is undoubtedly at the bottom of modern relaxation and fads. Too many people want to live by their wits and not by manual labor. A whole lot of the American people do not perspire enough. Men flock to towns and cities because they are easy places to make a living. They do not have to work so hard. They have a chance to meet and see other people, and, by their wits, take from them.

Americans should save more. In France, it is said—before the war—that if a man made four francs, he spent two and saved two. If an American makes four dollars, he borrows two and spends six. If the price of something is a dollar and the American has ninety cents, he does not wait until he earns the other ten, he gets trusted for it and buys—partly possible because of competition and the desire of the merchant to do business—partly an overdevelopment of the old factors first enumerated, ambition and the rest.

Amusement, relaxation and extravagant dress and life are over-emphasized and have become a craze, with periodic conscience-smitten returns to sane living. There is a turning from one fad to another all the time, which only gives the maker of the fad a fortune in his "get-away." This misleads those furnishing luxuries and extravagances to believe that the condition will always prevail. They are a *small* proportion of business men of the country, but making *large* profits. And that part of the income so diverted is taken away from those who provide staples and fundamentals who have had steady patronage in the past and provided for its continuance, and who are not told it is going

to cease. They are a *large* proportion of the business men making *small* profits.

A nation is only a collection of individuals, and this characteristic has been shown in the past by the wasting of our national resources. As a proof, cities that are blessed with more conservative people than some places, do not suffer as much as those other cities in times of panic or business depression.

A proper and reasonable amount of pleasure and relaxation is not only desirable, but necessary; but over-indulgence in any line *must* be avoided. The trouble is with those who cannot afford to do these things, but who, through the characteristics named at the beginning, will not deny themselves until they have reached the point in the upward climb where it is proper for them to participate.

A man's position forces him as he goes up higher in business life to live better, on a higher plane. If he has a customer from out of town and asks him home to dinner, and that home is on an undesirable street—and not well ordered—it would influence his guest and probably affect the dealings of the latter with one whom he deemed unsuccessful—but the process of "keeping up" should not be overdone. There should be a balance wheel in use all the time. There should be moderation in all things. There should be also conservatism in the business man and his methods.

We should see to it that local, state and national government have a business and not a professional or political administration.

As we have seen, business is the life of the people, and it should be fairly treated, hedged about with proper regulations, and the wrong doer should be promptly and summarily punished, *irrespective of who he may be*. We must not be afraid to stand for what is right and ethical, but we must be sane, even tempered, well balanced, watchful, energetic. We must build up and not tear down. We must educate and enlighten those who come to us with old-world antagonism to all that is successful. We

must show them and their children the advantages of our country, the opportunities they have for progress, and that liberty is not license.

We have the country, we have the resources, we have the people to supply, we have not in any measure reached the limit of interchange—we have an opportunity to supply the world besides. We have good national credit; we have a tremendous trade balance in our favor abroad from our heavy exports; there has been a rebuke to the demagogue and an intimation to him that it is not desirable for the successful to be further condemned. There are many movements under way for better government.

There is business confidence in large measure in most parts of our land today. The condition of being our own worst enemies shows very promising signs of being remedied in a large degree.

The commercial and industrial condition which we faced just before the breaking out of the European war—which would have been the worst our country had ever suffered—was avoided by the placing of orders from abroad and the subsequent distribution of wages, passing from the worker to the retailer, the wholesaler, the manufacturer. The latter in turn employed again those whom he had turned off for lack of work, and again distributed wages, which in turn were spent and supported other enterprises, and so the row of cards which had tumbled down were one by one set up again, each supporting another—its neighbor. But it was the attraction of great profits which practically forced those who took the initiative to go ahead, build, prepare, engage men, buy machinery and "start something." People had denied themselves so long that they returned to their mode of living of years ago with great relish and the pace was taken up again with such vigor and sustained because of the steady influx into our country from without of the original purchasing power, that we have today, in most sections of our land, the greatest business activity we have ever known—factories operating at capacity, all men

employed who can and will work, good wages being freely spent, luxuries and necessities bought and contracted for without thought of the future, a fever of excitement over all. We can not remain on this plane, for while there are always the old factors of war and the possibilities of war, social unrest, political changes, the ever-present tariff question, and others arising from the characteristics of man noted at the beginning, we have the factor of a false prosperity, false because it was forced, and is not the result of a natural

growth. And after the reaction has come and we have suffered, after the period of readjustment has been passed through, after our caution has been exercised, our natural vigor and enterprise will build again prosperity, to be disturbed later on, it may be, by the human factors we have noted, the "blowing up of the bubble," by extravagances, reckless living, speculation, forgetting the lessons of the past and getting the consequent day of reckoning, unless we can be wise and govern ourselves as we should.



What Makes One Bank Grow?

HERE are two banks with the same capital in the same town, both managed by honest and competent men, each beginning business within a year of the other.

In five years one of them has deposits amounting to fourteen times its capital, is a steady dividend payer and has accumulated what is called a "handsome surplus."

The other bank has half as much on deposit, is paying small dividends and its surplus is still in the infant class.

Same start, same town, same opportunity, same capital—must be something different in the men.

There are bankers who are so anxious to be known as "conservative bankers" that they lean over backward in their desire to be upright.

They wear black coats and a solemn face, and their bank is as silent as the grave.

This official austerity goes down the line, increasing from president to cashier, cashier to teller, teller to book-keeper—when it reaches the special policeman in the hall it is below zero.

This important special policeman looks at us as we timidly come through the front door, as though these were his thoughts:

"Is THAT all the deposit you're able to scrape up? Are you sure all those checks are good? You're not drawing

against them to-day, are you? Do you fully realize the favor that this GREAT BIG BANK is doing to a little depositor like you? Don't you ever dare come in here to discount a note—we're very conservative, we are, g-r-r-r."

If ever there was a form of human coöperation which absolutely depended on a 50-50 policy of give-and-take, it's a bank or trust company.

The earnings on the capital itself don't go very far towards paying dividends. It's only when capital is fertilized by human service that deposits grow and thrive.

In this upbuilding the depositors can play a big part.

When the teller unpins his packages after closing hours and cashes our check, a smiling "Thank you very much" always chokes an incipient frown.

When the cashier says "No" to a request for a discount and takes plenty of time to explain why he says it, and tells us the kind of a note that will bring a "Yes"—we go out of that bank in the right frame of mind.

This getting together is great stuff in any business.

Where is the teller that used to bark and bite and throw the pass book at us? Where is the skinflint depositor who always kept still when the teller overpaid him? They're probably rowing over the Styx in the same boat.—*The Chicago Daily News.*



TALKS ON BUSINESS BUILDING



By *W.R. MOREHOUSE*

Relating the Bank to Life Insurance

THE institution of life insurance, with its vast sums of invested capital, its millions of policyholders, and its thousand of agents, occupies a prominent place in the economic activities of this nation.

Although its growth has been largely since the Civil War, that growth has been very rapid. The life insurance in force to-day exceeds \$33,000,000,000. On January 1, 1916, the number of policies and certificates outstanding was more than 50,000,000, and the life insurance organizations disbursed to their patrons and claimants during 1915, nearly \$900,000,000.

LIFE INSURANCE SIMILAR TO BANKING

In many of its functions and purposes this vast organization of life insurance is similar to banking. It collects the savings of thousands into a common fund which can be loaned for the development of industries and the improvement of municipal enterprises. It places within the reach of the man of small means a safe investment and a plan of saving which nets a low yet certain rate of interest.

And in its coöperative and semi-public character it is closely allied to banking.

THE LIFE INSURANCE PROBLEM

While life insurance is more popular in the United States than in other countries, we are still greatly underinsured.

The amount of insurance carried is great in sum total, but it is small in proportion to life values. America carries but one-eighteenth of the amount needed to be fully insured.

To solve this problem insurance companies are carrying on great educational campaigns in behalf of life insurance as an institution, bringing its advantages to the attention of the public through all the common forms of publicity.

Such campaigns are helpful and necessary, but not effective by themselves. In the last analysis, the prospective policyholder, even though he realizes all the advantages of life insurance, comes to the real point of the matter and says "*I can't afford it.*"

THE FAULT

The man who says he cannot afford adequate life insurance may be right. But it happens in most instances that the reason he cannot is that he does not live within his income. Consequently, when the agent presents a plan of life insurance to him he cannot see where the money is to come from to pay the premium. Which is sufficient basis for the statement the up-to-date banker makes to the insurance agent, that "adequate life insurance protection rests primarily upon intelligent preparation for the payment of premiums."

A man cannot now, and never will be

able to carry sufficient life insurance, unless he follows a systematic, carefully worked out plan of preparation.

THE SAVINGS BANK PLAN

The savings department of a modern bank offers a solution to this problem. By depositing in a savings account one-twelfth of the annual premium each month, the premium can be met with ease. Life insurance will then be paid first of all, for the monthly pro rata will be put in the bank as soon as the salary is received.

PUTTING THE PLAN INTO OPERATION

Before the banker or publicity man can proceed with a plan of coöperation with insurance companies, he will have to "sell" the plan to his own officers and directors.

Here is an outline of the plan which was actually submitted to the senior officers of a large savings bank, and later approved:

Subject

CO-OPERATION WITH INSURANCE COMPANIES

Plan

To induce present and prospective policyholders to deposit in a savings account, monthly, bi-monthly, or whenever convenient, such amounts as will meet the annual premium at the end of the year.

Advantages

Advantages to policyholders:

(1) The annual premiums can be met with a minimum of effort by apportioning them into twelve monthly payments.

(2) The interest earned is clear profit.

Advantages to insurance companies:

(1) The prospective policyholder is more easily persuaded to buy insurance when the large annual premium is presented on a monthly basis.

(2) Fewer lapses occur when the policyholder is accustomed to meeting a small monthly payment rather than a large one yearly.

Securing These Advantages

Insurance companies have attempted to gain these advantages by offering policies permitting payments on a monthly or quarterly basis.

The plan is not at present satisfactory to either policyholder or insurance companies. The latter have found it necessary to make an extra charge of about four per cent. for this privilege.

When payments are made to a bank on the same basis, the monthly deposit is but one-twelfth of the yearly premium, and interest is paid to the policyholder in addition.

Advantages to Bank:

(1) New and increased term deposits, subject to slight variations only. The withdrawals would be fairly distributed over the twelve months of the year.

(2) Insurance agents will present to many people, in personal interviews, the advantages of saving and the power of interest.

(3) Through coöperation with insurance companies, new connections will be made which may be of value in securing reserve accounts, etc., from these companies and agencies.

Our Part in Plan

It is suggested that a small leaflet, setting forth the advantages of the method here presented, be placed in the hands of insurance companies, agents and others.

Cost

Five thousand of these booklets can be prepared at a cost of two cents each.

Part of Insurance Companies in Plan

The plan here presented has been taken up with the secretary, and the local manager, of an important life insurance company, and has met with their approval. Both of the gentlemen read the proof of the booklet, characterized it as "very well written," and assured us of their willingness to distribute the booklets to their customers and to present the plan to their agents. The local manager for another life insurance company, and a customer of the writer's bank, is already using this plan of meeting annual premiums. He carries one of our pocket safes himself to meet the premiums on his personal insurance, and has our steel safes on display in his office. He not only requires his agents to meet their own premiums in this manner, but also to use the plan in their "selling talks" to prospective purchasers of life insurance.

A number of new accounts have already been given us by this agency, which has offered to distribute our literature to its agents and customers.

What Other Banks Are Doing

The plan outlined here is original with this department and it was not learned

until recently that other banks were co-operating with insurance companies along the same line.

A middle western bank has been presenting it through newspaper advertising. Letters have been sent by it to the leading insurance agencies of the United States and to banks, presenting this plan and urging that it be generally adopted.

Present Need

It appears that the plan suggested is meeting with general favor throughout the United States and that definite results may be expected by the bank which is first to take advantage of it.

INTERESTING THE INSURANCE MEN

The banker who wishes to secure the coöperation of Life Insurance Companies in putting the plan into operation, does not need extensive preparation, but some knowledge of life insurance problems and activities is essential. A subscription to a first-class life insurance periodical will be found helpful in keeping in touch with the insurance field; and a frank talk with one or two agents will be worth while.

In inducing bank depositors to use this plan, all forms of publicity which will bring the matter to their attention are good. Letters, booklets, leaflets on check desks, and newspaper advertising, are all effective.

In securing the coöperation of agents, a talk before the general agencies of the companies offers the best opportunity of presenting the plan. Its advantage from the standpoint of the agent, that more life insurance can be sold where the burden of the premiums is lightened by a systematic plan of saving, should be the "bull's-eye" of the address.

Agents' meetings are commonly held by each agency weekly, and it is not difficult to secure an opportunity to speak on such a vital question. The idea can also be presented at meetings of the Life Underwriters' Associations.

Agents can also be interviewed on the subject personally. They should be urged to present the cost of insurance on a monthly basis, "Put \$5.00 a month into a savings account and we will pay your wife \$3,000 if you die."

If the banker uses a home safe, the agent may find it worth while to carry one with him to visualize the life insurance idea. He can then tell the prospective policyholder, "Put ten cents a day in the little safe and it will protect your wife and children."

The agent has a hard-selling proposition. Like the banker, he sells a commodity which doesn't smell good, taste good, or look good—and is for the benefit of some one else.

The home safe idea appeals to him therefore as a means of presenting his proposition in a clear, understandable way.

EXPERIENCE OF ONE AGENCY

One agency which was induced to enter a plan of coöperation such as is here suggested, now opens a savings account for every new policyholder, securing the loan of a safe at the same time, and instructs the policyholder in no uncertain terms as to the amount which must go into the safe every month in order to be ready for the next premium. The plan works admirably. The bank secured a constant supply of new accounts, and because of its own activity in helping the insurance company to solve its problem, secured the agency's cash account from a rival institution.

Savings accounts for policyholders are valuable to the bank, to the Insurance Company, to the agent and to the policyholder.

AGENCY ACCOUNTS

Before one has proceeded far with the plan of savings accounts for meeting insurance premiums, he will find that it is much easier to coöperate with agencies which keep their own accounts at his bank. Insurance companies and agents who keep accounts at rival institutions shy at endorsing your plan, and are not so enthusiastic as those who do business with you. It is therefore wise to keep a sharp lookout for agency accounts, and to secure as large a number as possible. Perhaps concessions in the way of free exchange may be granted in view of the fact that much valuable

business flows naturally to a bank through insurance accounts. However, one of the strongest pressures that can be brought to bear upon the insurance field to centre their accounts in your bank, is the vigorous prosecution of a plan for coöperation such as has been outlined.

AGENTS' ACCOUNTS

This plan will also help to secure the good will of agents and others related to the insurance field. The agent is generally a man of some influence in the community, has a fair income, belongs to a church and a lodge, and is a man of affairs generally, whose bank account alone is worth more to a bank than some other classes.

OTHER BANKING SERVICES

If a bank has a trust department it can interest insurance agents, who talk to men about the future constantly, to mention the value of a will and suggest a good executor.

Some trust companies aim to induce policyholders to put their insurance under a trust agreement which will insure wise administration of the funds after death.

It can then be arranged to pay the beneficiary in installments, similar to the plan of Life Insurance Companies to pay in monthly payments.

The Insurance Companies offer one real advantage in their plan, namely, that they take advantage of the law of average and can arrange to pay a definite premium from any date until the death of the beneficiary. This the trust company cannot do, for when the funds left at its disposal have been used, it can no longer pay, trusting as the insurance company does, to some other

case where the beneficiary lives for a shorter period, to make up the loss.

In this instance the plan of the insurance company seems superior, but there are many instances where a trust company acting as trustee, or even as executor, can profitably be named as beneficiary.

If it has a safe deposit department, the agent can suggest when he delivers a policy that it is worth while to put it in a safe deposit box.

And when a policyholder dies, the insurance man can suggest most effectively to the claimant a safe and convenient place for the insurance money when it is paid.

Realizing the advantages of agents' coöperation, some banks have taken to "advertising life insurance" by using newspaper space to "boost" the life insurance business. Such means may be effective, but they go rather too far. Not enough people use life insurance, to be sure, but an equally large number do not realize the value of a bank account, and the banker can best use his valuable space to tell his own story.

Some banks have entered into special compacts with Insurance Companies to secure the advantage here presented. Such entangling alliances are undesirable. Sooner or later they are found to be more or less complicated.

The banker's best plan is to offer valuable service to the Insurance Companies in the regular line of banking facilities, and special services adapted to their needs, and to offer these to all Insurance Companies on an impartial basis.

Only in this way can the banker secure for his bank and for himself those advantages which naturally will follow his intelligent efforts to relate his business to that of life insurance.



BANKING SERVICE for WOMEN



Getting Women to Bank at Your Bank

WRITING on this topic in *THE BANKERS MAGAZINE* some years ago, Mrs. E. B. B. Reesor, then manager of the women's department of the Crown Bank of Canada, Toronto, said:

"Ask them; ask them again; keep on asking them. And when they come to the bank, let them know that you are glad to have them come. Give them something to help them to save, and teach them in every way you can to keep on saving; but never, for one moment, allow them to know that they are being taught; remember, it is always their own common-sense that guides them. These customers once gained are always yours, and they will bring others.

"There are many ways in which a list of prospective customers may be compiled. The daily papers announce births, marriages, divisions of estates, new arrivals in town, the opening of new businesses—such as millinery establishments, dressmaking, art rooms, etc., etc., and as each day comes add to the list and use your own judgment in your manner of approaching the prospects—whether by written invitation or by a personal call.

"The society blue-books, city directories, year-books of churches, lodges, colleges, etc., all contain lists of live names which need not be copied into a book, but can be taken at any time from the printed pages. Under your

guidance your secretary can focus her attention upon, say, 100 of these names at a time, find out the financial standing of the persons to whom they belong, and try to get in touch with those who have capital or are earning money, but who have no bank account. You need ask no favor of these people; you should not think that you are putting yourself out for them—it is the best kind of help all around, for money in a bank is for their use, is for the bank's use, is for the country's use—and it is the grandest practical lesson in helping people to help themselves that can be taught."

Advertising novelties may be employed if desired, and of these an inexhaustible line can be found suited to woman's tastes and requirements.

The officer in a bank who can answer all questions is a great help, and cheerfulness and unflinching courtesy are magnets that will draw and hold the woman patron.

"How many women in your town are in the same position as this one? 'I was talking with a woman just yesterday,' said the manager of an uptown branch of one of New York's biggest banks, 'who said she didn't open an account with us because she didn't 'need to.' " I asked her if her husband didn't give her some money every month to run the house with. "Oh, yes," was the quick reply; "he gives me \$300 a month,

but I just keep it in the upper drawer of my bureau. I spend it all by the last of each month, so it wouldn't be worth while to put it in the bank.'"*

"A few wise words as to the unsafety of such a course of procedure and the convenience of a checking account won her over completely, and she then and there made her initial deposit with the significant words, 'Why, I didn't know you would want the account!'

"Do the women of your town know you want their accounts? Be sure to let them know it. They are the logical disbursers of a greater part of the family income, which in homes of moderate means finds its way monthly to the butcher, the baker and the candlestick maker. Just the other day, a New York judge handed down the decision that a man need not pass over his pay envelope to his wife of a Saturday night unopened. He might sneak out a quarter or so for a haircut, or fifty cents for carfare, but no one questioned the fact that he must hand over to her the major part of his earnings. To lure these from the tea-caddies, handkerchief baskets, wrist-bags and more personal hiding places to the bank, en route to the landlord and tradesmen, it is absolutely essential to let the women know that it means good business for you and greater safety and convenience for them. Whether it be a simply worded statement in a conspicuous place in your local paper, or a pleasant invitation placarded in your ample window space, let them know you want them as depositors and also the amount of the monthly balance you would want them to keep. (Concessions in this latter are generally made to school-teachers and professional women, but that is a matter for personal adjustment later.) Many women do not open an account because they imagine you would want them to keep some impossible balance on hand, and like everyone else they dislike to ask and risk being told they are not desirable customers.

"When a woman who has read your

invitation, crosses the threshold of your bank for the first time, there should be someone to step forward immediately and put her at her ease by finding out exactly what she wants and showing her how to go about getting it. To a woman unaccustomed to business, there is no more awkward moment than when she stands just inside the bank door, uncertain whether to try to see the president or the paying teller, and usually conscious of the rude stares of a number of clerks who are too busy to leave their work and find out what they can do for her, but not too busy to gaze at her curiously and then exchange whispered guesses with each other as to who she is, what she wants, etc., etc. One city bank had to make a special rule prohibiting clerks whose work was finished early from standing on the bank steps and staring at the women who went in. However, if there is some young clerk, preferably clean-cut and carefully dressed, of attractive personality, whose duty it is to greet newcomers who look about uncertainly, and pilot them safely to a proper destination, the awkward moment can be agreeably abridged.

"If your bank is not large enough to warrant employing a "new account" man whose sole duty it is to attend to that branch, this young man should be possessed of sufficient knowledge to explain to the new depositor the essential details of handling a bank account. He must be patient and courteous above all, and over-ready with information rather than reticent, as women dislike to ask questions on unfamiliar subjects, thereby perhaps displaying their ignorance of the simplest business transactions, particularly in a bank."

Here are a woman's suggestions* "as to how to reach the heart and purse of that seemingly most mysterious creature, woman, and to civilize and commercialize her to the extent of making her to keep a bank account."

"Of course, we all know t

*"The Woman and the Bank." L. and R. Dean, "Bankers Magazine," New York, August, 1915.

**Women and the Bank. Selley, teller in First National Bank, "Bankers Magazine."

want something these days the proper thing to do is to advertise for it. In other words, let our wants be known.

"Now, to me, the vital point of all advertising is to know the people you want to attract. If you know the mark you are aiming at, you stand some chance of hitting it. And if you want to talk business and banking to a woman, you must know something about her sentiments on that subject so you will know how to approach her. It is a matter that requires some tact.

"At the hazard of hurting your vanity, I must tell you something that experience has taught me. 'Women do not prefer to have men clerks wait on them!' At least, not always. I will tell you how I found out about it. No, no, it is not a matter of whether a clerk be male or female, it is Service that counts, and I shall leave you to judge whether a man or woman is best suited to the work of waiting on women.

"At one time I, too, thought that women preferred men. I believed it so completely that when an official of our bank asked me if I would care to take charge of the ladies' department I gave him a positive 'no.' I was satisfied with my work then in the collection department, and I did not want to go where I would not be welcome, being rather timid by nature. However, at the first of the following year the president sent out instructions for me to go to the ladies' department at once. I went.

"I have been for some time interested in women of all types, in their joys and sorrows, their work and their ways. And as money always comes pretty near one's heart I soon realized that I had a good place to learn much of the feminine human nature.

"Our ladies' department had not been exactly thriving, and I asked permission to work out some ideas I had for advertising it. I had never written an advertisement in my life, and was surprised when the officials were willing to trust me with all the advertising in connection with the ladies' department.

"First I wrote personal letters to all the women depositors on our books, telling them that the department had been given to me, and that while they were

welcome to any part of the bank, and could transact their business where they chose, I would very much appreciate it if they would patronize me. I thought it best to let them know that they were not being segregated because of any nuisance law. I also stated in my letter that our gallant officials had established the department as a special courtesy to gentlewomen, that banking might be less irksome to them. I told them about our special room, beautifully fitted with every convenience which they were welcome to use at their pleasure, and of our unusual service which would make a pleasure of their usually tiresome business. I invited them all to visit the department and to bring their friends to it, and to use their influence to help me make the department one of the best of its kind anywhere. It was entirely a personal appeal, and I have found out since that that is the only way to appeal to women successfully.

"I followed this letter with another letter inclosing an artistic blotter, made of good blotting paper and not cardboard, explaining that knowing the usual dearth of blotters on the home desk, I had this one made especially for our depositors. I also sent this letter to a list of prominent club women, calling attention to the fact that the modern women could not afford to be without a bank account, explaining how it saved their time, strength, and money, the three most important factors to successful life. I also gave out small memorandum books and screw pencils which are useful to carry in small purses. I did not get check books of every size and color, but I did order a supply of good plain open check books and substantial pass books large enough so that the writing in them could be read by the older women, and some 'nut-shell' folders for the younger women. I knew that the new purses would not accommodate the large open check books, and I always explain to my patrons that I ordered the folders for their convenience. I chose dark red leather covers with separate check fillers, and they are very attractive, though a bit expensive. However, I feel that I can give them out with small

accounts, as they are a good advertisement. Women are always delighted with them and are sure to show them to their friends. I know that this alone has brought me a number of new accounts. The older women carry large hand-bags and they prefer the larger books. I am careful to use plain black ink, as the older women are unable to read the blue ink after it is blotted. I have given attention to details and added everything I could think of to make my service good.

"When I open a new account I always thank my patron kindly, tell her not to hesitate to ask me to assist her with any of her business, and that it will be a pleasure to see her come often to our bank. I also never fail to ask them to send their friends to me. It pays to do this, as you make a staunch friend of a woman who has done something for you. If they think they are helping me, they often do personal work among their friends and bring me new accounts. Only yesterday a woman who has brought me several new accounts said that she was going to bring me her sister's account from another bank. I asked her what she thought of women bankers, and she said that the only reason her sister had agreed to leave her bank was because we had a woman teller. She was quite sincere in her statement. She also said that many times women were timid of asking questions of men, feeling very ignorant of anything pertaining to business and hesitating to take their time.

"When I see how many friends I have made, and how good and kind my patrons are to me, and how they help me, and in a way love me, I am ashamed that it was with reluctance that I took charge of the woman's department. But I did not know that they could possibly prefer me to a man; and, believe me, it is in all humility that I say it, but I am sure the best looking man in town could not take my patrons away from me, the majority of them anyway. It is not because I am not a man, but because I give them sympathetic and sincere service. They trust me because I have proved myself capable of doing the work. Before tak-

ing the ladies' department I had had ten years of work in almost every department of the bank and I know how to answer all their questions. Often they tell me that they think I'm quite a wonder to know these things, but I always explain that there is nothing wonderful about it. That it is not half so difficult as housekeeping and dressmaking, and that any woman could learn it if she would apply herself to it.

"There are many departments of the bank where women would serve better than men. All savings departments ought to have women tellers. Surely nothing less than woman's patience could deal with the ignorance of women, foreigners, negroes, children, and lunatics who come daily to that department. I am sure that with sympathetic, interested, patient tellers these departments would increase their deposits greatly. It breaks my heart to see a teller impatient with an ignorant person. It seems that the very ones who need help are the ones who are rebuffed and frightened away. Men forget that everyone has not had the opportunity they have had to know things, and that the most ordinary item is often a deep mystery to others. I would not be impatient and unkind to anyone. I would rather absolutely refuse to wait on one than to do it in an ungracious manner. I try always to remember that I talk for my bank, and to do it courteously, no matter how unjust my customer chooses to be. It is often very trying, and I came near losing my temper once when one of Nashville's rich, supposedly cultured women, asked me to 'lick a postage stamp.' But I calmly rubbed the offending stamp over my wet sponge, and saved the day. I am not sure that I kept the disgust from showing on my face, but I did the best I could.

"I do everything I can to make myself necessary and helpful to my patrons. I do not make a show of my knowledge and count money so fast that it makes the head swim. I can count it quickly if I choose, but it is not best in my department. I count it slowly, and allow my patron to count it with me the second time, for I know how hard it is to count with gloves on and a hand

full of bundles. When packages of currency are numbered, and I merely go by the numbers, I do not leave the impression that I have guessed exactly right, as I have known some clerks to do, but explain the trick when I am asked how I made it come out even. These little things inspire confidence.

"I always pay clean, new money, in denominations convenient to be used in the home, trying always to remember how the most particular of my patrons wish their money changed. I always try to please them. Often they apologize for troubling me when they ask that I change the denominations of their money to suit them, but I make them know that it is my business to please them and my pleasure also.

"I also help them with making out their checks when they need me, and income tax certificates, though that is not one of my duties. I help them in every way I can, and that is the only way I made them prefer me to a man.

"To sum up my service, I would say I tell them everything they want to know, and allow them, so far as possible, to do their banking to suit themselves. I am sure this is the only way to be a successful woman teller, and I honestly do not see how an ordinary

man could tell them everything they ask of me.

"Perhaps the greatest and most gratifying result of my labors is a line-up where once there was an aching void, for our department has grown, and, as times have been unusually dull and money scarce, I somehow feel that the increase has been on account of my work. I have advertised in several ways, though it has not cost a great deal. I gave out calendars, sent out monthly cards with a personal message, written, or rather facsimiled, on it and signed personally. All of my advertisements and letters are written by myself, and always with a personal touch. I am learning something every day, and hope to keep the department thriving and growing.

"And the whole secret of such success as I have had is my sincere interest in my department and the unselfish giving of myself in my service."

As to whether women tellers should be provided to care for the receipt and payment of women's deposits, there is diversity of opinion; but that a woman should be in attendance at the woman's department is universally conceded. The practice of employing women as tellers in banks has grown of late years and generally with satisfactory results.



The Quantity Theory of Money

WRITING in the "Journal of the Institute of Bankers," London, in regard to the "Quantity Theory of Money," Mr. Ernest Sykes, after stating that this theory "has found general acceptance with English economists since the time of Stuart Mill," says:

"In the United States only has there been any serious opposition to the principle. In that country, owing to the long drawn out controversy between the silver party and the sound currency advocates, the question was for a time a political one, and a section of American economists who were in favor of the unlimited coinage of silver, at-

tempted to controvert the quantity theory. Their efforts have now been discredited, and it may truthfully be said that there are few, if any, among the leading economists of this or any other country who refuse their assent to the truth of the theory."

This is a clear case of putting the cart before the horse. It was Mr. Bryan and his followers who clung to the quantity theory and the gold standard men who controverted it. And surely, if anybody was discredited, it was not the friends of the gold standard, but those who were in favor of the unlimited coinage of silver.

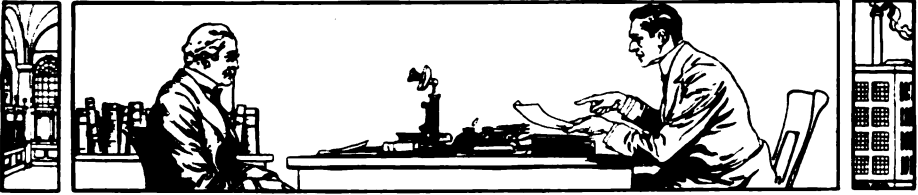

The Business Counselor—The New Factor in Banking

Readjusting Business to Meet War Conditions

By GEORGE KINGDON PARSONS

[This is the second of a series of articles by Mr. Parsons dealing with the subject of scientific business management and its relation to banking.—THE EDITOR.]

The most notable effect of America's entry into the Great War will unquestionably be the development of greater national efficiency. At the outset, by reason of the readjustments made necessary in the field of labor, there must necessarily be a period of industrial confusion. This will be followed by a period in which the industrial forces gradually accommodate themselves to the new order of things, and out of it all we will at last emerge into an era characterized by thoroughness and efficiency of the highest order.

Let no man delude himself with the idea that efficiency in these times is a negligible thing—that it may be either fostered or let to lie at the will of the nation or individual. It is not a question of whether or not we want to be efficient; we **MUST** be efficient if we expect to survive. War demands it. The industrial situation exacts it. Old man Mars can not fight his battles alone. He needs the backing of the entire nation. And while the nation is helping old man Mars it must also take care of itself and, to a great extent, look to the welfare of its allies. The task is a colossal one, its accomplishment being pos-

sible only by a concentration of the intellectual forces on the problems in hand—a quick sharpening of the national wit with the object of effecting super-refinements in methods and processes throughout every department of business and industrial endeavor.

DRAFT AND ENLISTMENT

The first problem is to provide substitutes for those who represent us on the battle front. As the war progresses, withdrawing from their vocations vast armies of industrial workers, we begin to cast about for ways and means of continuing business as in normal times. Although the demand for our product or our services may be as great or even greater than before, the man-power necessary to meet this demand will be sadly deficient. No matter how gradual the process of withdrawal may be, its very magnitude will be sufficient to make the loss of trained workers felt throughout every nerve and fibre of the industrial organization. In order to compensate for the immense loss of men and maintain the integrity of the business fabric as a whole, recourse must be had to various expedients.

BANKS AND WAR

Before considering this phase of the situation, let us digress for a moment to discuss the relations of the banker to the altered conditions brought about by the war. The banker always has been and always will be the dominant figure in war, although modestly occupying an inconspicuous position in the background of public affairs. Upon the banker rests the responsibility of engineering vast financial movements upon which the success of the war is directly contingent. More than ever, to-day, is the truth of the trite old adage apparent, that "Money is the sinews of War." And it is the banker to whom we must look for money.

Never in any previous war has the resourcefulness of the banker been put to so great a test as it is about to be subjected to, for the banker is now called upon, by reason of the gigantic scale of the present struggle, to deal with financial problems of unprecedented magnitude. But these responsibilities constitute only a part of his labors. The other part—in reality a far more difficult one—embraces a large number of relatively small responsibilities, having to do with the conduct of business enterprises of which he is the financier. The situation confronting the banker at the present moment is therefore unusually trying. In the altered conditions now existing, he is called upon to make decisions in the matter of loans which may have a far more important bearing on the public welfare than they would have in ordinary times. No opportunity must be overlooked to advance funds where deserved, and where their employment will react advantageously to the general cause. On the other hand, a finer discrimination than ever must be exercised in loaning money for the development of enterprises which might not turn out well and which in consequence would result in economic loss. Thus, a double responsibility rests upon the shoulders of the banker—to see to it that legitimate business is given every chance to thrive and that at the same time plausible but questionable enterprises are af-

forded no unwarranted encouragement.

Facing conditions such as these it can be readily seen why the banker, submerged as he is by the duties of his profession, should find it greatly to his interests to requisition the services of business counsel, where knotty business problems are involved, in precisely the same manner as he confers with a legal advisor on questions pertaining to law.

BOYS, WOMEN AND OLD MEN

Going back again to the subject of labor shortage, as caused by the withdrawal of male workers, let us consider the expedients which will be employed to offset this condition. There are four visible methods of bridging this gap: the employment of women; the employment of middle-aged men; the employment of youths; the introduction of methods which will permit the work to be done by a lesser number of employees.

Of the first, the employment of women to take the place of men, much may be said. In Europe, driven by dire necessity, women are to be found in large numbers in many occupations formerly accepted as lying strictly within the province of masculine ability. Yet it can be said that the employment of women in these "unusual" occupations is not entirely novel, for in isolated instances women have for years been doing practically every class of labor commonly assigned to men. While the fact that women, under the stress of present conditions, are acquitting themselves admirably in many masculine roles, may prove that they undoubtedly afford a fair makeshift, it does not disprove the contention of sociologists that the permanent employment of women in vocations peculiar to men has a pernicious effect upon society in general. Statistics show that in communities where women as a class segregate themselves and become self-supporting there is an invariable deterioration of the home life which is conceived to be the basis of our modern civilization. The direct result of this unbalanced relation of the sexes is a tendency to fewer marriages, fewer children and the concomitant phenome-

non, an appreciable increase in disease and evil.

The remedy, then, would seem to lie in other directions. A wise and logical step has been taken in employing older men rather than very young men and boys. This plan, which has already been successfully adopted by many concerns, has brought into business, perhaps, less snap and vigor, but it has certainly brought riper judgment and experience, attributes which frequently accomplish more than youth. An increasing number of gray heads is to be seen in the counting houses, stores and great industrial plants, in a measure satisfactorily offsetting the exodus of young men.

From the more youthful element of workers little genuine aid can be expected. Extreme youth has its limitations. The blunders and incompetence of youth are bywords in business. Taking, therefore, three of our four elements—women, middle-aged men, and youths, we find that all of them combined do not "fill the bill." There is no labor class, individually or conjointly, which can satisfactorily take the place of prime-of-life trained manhood.

What is the alternative?

THE PARADOX

Labor-saving and time-saving methods. In other words, scientific business management under the guidance of the business counselor accomplishing the same amount of work with a decreased force.

This is apparently a paradox, but although it may not seem plausible, results show that where science steps in to make a careful study of the situation, whether the work be clerical or manual, the number of workers can almost invariably be reduced from ten to twenty per cent. without entailing any hardship on the remaining force. The ways by which this may be accomplished are manifold, but they all come under the general head of making every motion count. If a clerk or a machinist makes a move it must be a profitable move. This does not mean a drive at a faster

pace, but the elimination of all false motions and wasted time so that both may be converted into useful production.

The following incidents, selected from a large number of cases, will serve to illustrate the general principles upon which scientific business management operates.

An office which thought that it required seven stenographers and clerks found that it could easily get along with five, without any addition of equipment whatever, simply by discontinuing the practice of piling work upon one while another was idle. One of the greatest wastes in office help lies in the theory that each petty officer as well as principal must have his own private secretary. Where this system is in force the secretary usually refrains from doing any work except that delegated by his or her immediate superior, and if the superior is not careful or over conscientious, there are times when the secretary's time is wasted. The elimination of supernumeraries also makes for economy by reducing the floor area required, in that way cutting down rent.

Over and above the economy due to better organization, there are thousands of cases to prove that the introduction of dictating machines, computing machines and other time-saving appliances have reduced the number of office employes from twenty-five to fifty per cent., depending on the nature of the work.

A large accounting department formerly had ten ledger men. Now the work is done, and done better, by two because, instead of handling cumbersome ledgers, they handle individual records. A bank employing three bookkeepers found that it could get along just as well as before with two, thanks to a change in the form of the books, made at the instance of the business counselor.

Not long ago a certain concern was turning out flanged discs at the rate of about one hundred per day. It required two men, operating a hydraulic press, to secure this limited output. The manufacturer was convinced that, owing to

the peculiar quality of the material, flanged discs could be manufactured by no other method, but a demonstration proved otherwise. They are now making 20,000 discs a day on a geared power press operated by one man!

A large manufacturer of men's clothing could not give a satisfactory explanation to a business engineer as to the reason for the excessive amount of goods turned over at the seams. An investigation in the sewing room developed the fact that they had always turned over this amount of material in order to allow a safe margin. Further investigation showed that the patterns were of paper, and variable in size. By supplanting the paper patterns with fibre, with rounded corners to make possible more rapid cutting, the net result was a saving of twenty per cent. in material and eighteen per cent. in labor.

A factory manufacturing overalls and jumpers had progressed so far, due to the activities of a salesman of electric cloth cutting machines, that they cut many thicknesses of cloth at one time. This work was done by high salaried expert cutters who were forced to waste their valuable time while waiting for boys to unroll the bolts of goods on a cutting table sixty yards in length. In order to keep the cutter busy while the boys were unrolling the bolts it was pointed out by the business engineer that a very large part of the product comprising edged bands, cuffs, etc., could be cut from the bolts without unrolling, simply by breaking out the board from the centre. The adoption of this suggestion resulted in reducing the labor one-third.

In a big city laundry it had been the practice to dump the soiled articles indiscriminately in the sorting room as they were received from the various collecting wagons. This method had the effect of piling up a large volume of soiled articles at one time, necessitating the employment of sixty sorters to handle the situation when the collection was at its maximum. A little study of the proposition suggested the plan of making the soiled collections by zones and sorting collections separately. The

congestion and confusion which had previously been occasioned by the dumping of soiled articles in overwhelming numbers, with corresponding slack periods in between, had the effect of feeding the soiled articles to the sorters in a steady, even stream, with the result that the number of sorters was comfortably reduced from sixty to thirty.

Instances like the foregoing, which could be cited indefinitely, show how easy it is, with a little intelligent application, to cut down labor and conserve human energy. It is estimated that the immediate military requirements will call for the drafting of one million out of ten million men, that is, ten per cent. of the young manhood of the country. Neither bank nor store, factory nor mine, will be immune from the call to arms, but in view of the savings in labor made possible by scientific management—savings which do not stop at a mere ten per cent., but which go as high as fifty per cent.—there need be no cause for alarm at the thought of losing our employees. The industrial forces of the country will suffer only a temporary shock if we will but stop long enough to learn the lessons of economy and efficiency taught by scientific business management.

THE SOLUTION

And it is right here, as previously pointed out, that the banker plays an important role. No man is closer to business than the banker. His finger is ever on the pulse of industry. It is he, outside of those who are the active directors of business, who first feels the fluttering of that pulse in periods of stress or unrest. It would seem only logical, therefore, that the banker should acquaint himself intimately with the possibilities of scientific business management, with a view to recommending the employment of its forces in business enterprises which he is financing, for in so doing he accomplishes three vital things—safeguards his own investment, promotes the welfare of his client and confers a benefit on the country at large in pointing the way to greater efficiency.

Banking and Commercial Law

CASE COMMENT AND REVIEW

Sending Checks Direct For Collection

IN the collection of checks it often becomes necessary to collect checks on banks that constitute the only bank in the town, and the items must either be sent to the drawee bank direct, or to a collecting agency such as an express company. In making collections thus, the courts have held almost without exception that collecting direct constitutes negligence, and in case of non-payment, the collecting bank is liable to the depositor.

In the present number such a case appears. Bank A held checks on bank B which were sent direct to B. B remitted its draft, but before the draft was paid bank B failed and the draft was dishonored. Had the collection been made through an express company, cash would have been collected for the items. The court in this instance falls in line with the trend of the decisions and holds the sending bank liable to its customer.

The only safe method is to have an agreement in the pass book to the effect that direct collection is consented to by the depositor, which places the burden upon him and not the bank. (See *Wingfield vs. Security National Bank.*)



Telegraphic Acceptance

In the conduct of business it becomes needful to use the telegraph for many important purposes, and transactions involving large sums of money are daily consummated through the wires. Remittances of money, messages entailing

the exact transmission of prices, and other agreements, are made by wire and the need for accuracy is obvious.

Likewise in the drawing of drafts. At times it is essential to know that a draft will be honored when presented, and while presentment cannot be made by wire, the acceptance of the instrument may. In the current number we review a case in which the telegraph was used for the latter purpose. In closing a business deal, a telegram was received to the effect that a draft would be honored "telegram attached." It was drawn and the telegram attached, sold to a bank, payment refused and suit followed. Without going into the case in detail as to what telegram was meant, suffice to say the telegraphic acceptance was held binding.

Technically speaking, an acceptance must be in writing and on the face of the instrument, and while a telegram of acceptance is not on the face of the instrument, it is in writing, and is held binding upon the sender, if the paper is in the hands of one who parts with full value for the same on the strength of the telegram of acceptance. (See *Ensign vs. Clark Bros. Cutlery Co.* in this issue.)



Presentment for Payment

A negotiable instrument must be presented for payment on the day it is due and at the place named in the instrument, or the indorsers are discharged. And in making this presentation, due diligence must be used in order to show such effort as will satisfy the law that the holder was not remiss.

In this issue we present a case where

the messenger of the bank carried a note due at a certain business place, a brick building, with restaurant on the ground floor and business places above. He thought he saw a letter box in the hall, but did not remember whether it bore a name or not. He looked for the name of the maker of the note, but did not find it. He then inquired in the restaurant without success. He accosted a man coming downstairs and got no information, looked up at the windows and finding no name, abandoned the search. The maker of the note proved that he had been in the building for three years, and had a letter box with his name thereon, and that there were but five occupants of the building, and that he had a certified check ready to meet the note. The note had been charged to the indorser and on suit was held not to be allowable on the theory that due diligence had not been used in making presentment.

This is also a caution for messengers, for they hold an important place in the banking scheme and can involve their bank in law suits and losses by such negligence as is inexcusable. (See *Cohen vs. Chelsea Exchange Bank* in this number.)

Leading Cases

Sending Collections Direct

SOUTH DAKOTA

Presentment for Payment—Negligence

Supreme Court of South Dakota, April 2, 1917.

WINGFIELD, PUBLIC EXAMINER VS. SECURITY
NAT. BANK OF SIOUX FALLS.

Where one bank, holding two checks against another, sent them to a third for collection and credit and the third bank, instead of sending them to the express company at the town of the second bank, there being no other bank there, sent them direct to the bank, which remitted its draft on a fourth bank, and such draft was dishon-

ored, the collecting bank was negligent in sending the checks to the payor where, had the checks been sent to the express company, they would have been paid, and the rule applies with additional force in the case of a cashier's check.

In an action by the holder bank against the collecting bank for negligence in improperly presenting checks to the payor for payment, the collecting bank has the burden of proving due diligence, or of proving that the loss would have been the same had due diligence been used.

Action by J. L. Wingfield, as Public Examiner and Ex Officio Superintendent of Banks and Trust Companies, against the Security National Bank of Sioux Falls, S. D. From an order sustaining demurrer to the complaint, the complainant appeals. Reversed.

STATEMENT OF FACT AND OPINION

Whiting, J. Appeal from an order sustaining a demurrer to a complaint. The following is a statement of the facts admitted by the demurrer. Bank A, holding two checks against bank B (one a cashier's check executed by bank B), sends them to bank C for collection and credit. In the town where bank B was located, there was no other bank, but there was an office of an express company, which company was engaged in the business of collecting and transmitting money. Instead of sending the checks to the express company for purpose of collection, bank C sent them direct to bank B, which bank remitted its draft on bank D in payment of such checks. This draft was dishonored. If bank C had sent the checks to the express company, the same could and would have been presented for payment on November 10. Up to November 13 bank B paid all checks and demands drawn and made upon it, and it would have paid these checks in cash if they had been presented and payment in money demanded on or before November 13. Bank B was insolvent on November 10, at the time said checks could, in regular course of business, have been presented by the express company, and it has remained insolvent and unable to

pay its obligations in full. On November 13 it passed into the charge of the public examiner. Bank A passed into the charge of the public examiner prior to the bringing of this action.

Appellant claims that bank C is liable for the amount of said checks, owing to its negligence in sending said checks to the payee bank and accepting from it a draft instead of sending the checks to the express company and thus procuring cash. Respondent claims: First, that it was not negligent in sending the checks direct to payee bank; second, that, inasmuch as the payee bank was in fact insolvent when such checks would have been presented if presented by the express company, the payee could not rightfully have paid such checks in full, and therefore appellant has suffered no damage.

That it was negligence for bank C, under the admitted facts, to send the checks to the payor bank is clearly the law. *Michie, Banks and Banking*, 1045; *Winchester Milling Co. vs. Bank of Winchester*, 120 Tenn. 225; *Givan vs. Bank of Alexandria (Tenn.)* 52 S. W. 923; *Pinkney vs. Kanawha Valley Bank*, 68 W. Va. 254; *First Nat. Bank vs. Bank of Whittier*, 221 Ill. 319, 77 N. E. 563; *Farley Nat. Bank vs. Pollock*, 145 Ala. 321; *Carson, Pirie, Scott & Co. vs. Fincher*, 129 Mich. 687. This rule applies with additional force in the case of the cashier's check. *First Nat. Bank vs. Bank of Whittier, supra*, and notes 5 Ann. Cas. 658; *Anderson vs. Rodgers*, 53 Kan. 542.

It appears that the decision of the trial court sustaining the demurrer to the complaint was based upon the holding of this court in *Lamro Bank vs. Bank of Winner*, 34 S. D. 417. In that case this court held that, when a check upon an insolvent bank is presented for payment, the holder of such check is "entitled to only its pro rata share with the other creditors in the assets of the * * * bank." We also held that it would be presumed that an insolvent bank would refuse payment if a check was presented. A legal presumption has no standing as against an admitted fact. Here it is admitted that the payor

bank, though insolvent, would have paid the checks in cash if such checks had been presented and cash demanded. There is nothing to show that either bank A or C knew of the insolvency of bank B prior to November 13. If neither of the other banks knew of such insolvency on November 10 and bank B had paid the checks, other creditors of bank B could not have held bank A liable to restore the proceeds of same to the insolvent bank. *Michie, Banks and Banking*, 507; *Livingstain vs. Columbian Bkg. & T. Co.*, 81 S. C. 244; *Stone vs. Jenison*, 111 Mich. 592; *McGregor vs. Battle*, 128 Ga. 577.

It follows that bank C is liable under the facts conceded. It is incumbent on it to prove facts establishing due diligence on its part or else to establish that the loss would have been the same if it had used due diligence. 3 R. C. L. 628; *Michie, Banks and Banking*, 1407; cases cited in note 8 Ann. Cas. 373; cases cited in note Ann. Cas. 1912B, 123.

The order appealed from is reversed. 162 N. W. Rep. 309.



Acceptance by Telegram

MISSOURI

Conditional Acceptance

Kansas City Court of Appeals, Missouri,
March 5, 1917.

ENSIGN ET AL. VS. CLARK BROS. CUTLERY CO.

Under Rev. St. 1909, section 10105, providing that an unconditional promise in writing to accept a bill before it is drawn is deemed an actual acceptance in favor of every person who upon the face thereof receives the bill for value, where defendant by wire promised to honor a draft "telegram attached," one who paid full value for the draft, and to whom the drawer's indebtedness was thereafter at no time less than the face of the draft, is entitled to recover thereon unless the telegram of acceptance be held a conditional acceptance, in which case he can recover only on showing compliance with the condition.

Under Rev. St. 1909, section 10111, defining a "conditional acceptance" as one de-

pendent upon the fulfillment of a condition therein stated, a telegram promising to honor addressee's draft "telegram attached" was an unconditional acceptance of a draft with that telegram attached, as affecting the rights of a purchaser, though the telegram intended by the acceptor to be attached was a different one.

Action by C. B. Ensign, doing business as C. B. Ensign & Co., against the Clark Brothers Cutlery Co. From a judgment for plaintiff, defendant appeals. Affirmed.

STATEMENT OF FACT AND OPINION

Trimble, J. Plaintiff sued defendant as the acceptor, in writing, of a certain draft for \$1,500, payable on demand, dated April 22, 1913, drawn by F. M. Pease in Chicago on defendant located at Kansas City, and transferred for value to plaintiff. The case was tried by the court, a jury being waived. The court made a finding of facts and rendered judgment for plaintiff for the full amount represented by the draft with interest. Defendant has appealed.

On April 22, 1913, the defendant at Kansas City sent the following telegram to F. M. Pease at Chicago:

"Will honor your draft fifteen hundred dollars telegram attached. Clark Bros. Cutlery Co."

Thereupon, Pease drew the following draft:

"\$1,500. Chicago, Apl. 22, 1913.

"On demand pay to the order of F. M. Pease fifteen hundred dollars, value received, and charge the same to account of Clark Bros. Cutlery Co., 628 Broadway, Kansas City, Mo.

"F. M. Pease."

And, with the above telegram attached thereto, he indorsed and delivered it to plaintiff and received from the latter the money thereon. Plaintiff, in due course and through the proper channels, sent the draft to defendant, but the latter declined to pay it, whereupon it was duly protested.

According to defendant's testimony, Pease, prior to April 22, 1913, had been

employed and engaged in the endeavor to consolidate, and effect the purchase of, certain properties or factories at Watertown, Conn., though up to April 22, 1913, nothing definite had been accomplished in that direction. Defendant's further testimony was that on said date Pease told defendant over the long distance telephone from Chicago that he had received a telegram from Watertown, Conn., giving Clark Bros. Cutlery Co. an option on the purchase and consolidation of the factories and that it would require \$1,500 to pay for the option in addition to what Pease had put up or provided, and requested defendant to honor his draft for that amount; that the defendant agreed to do so if Pease would attach the Watertown, Conn., telegram to the draft so that defendant would be assured that Pease had some tangible agreement from the Watertown parties; that shortly after such telephone conversation, and on the same morning, Pease sent a telegram to defendant asking him to wire authority to draw, as he perhaps could not get the draft cashed in Chicago without such authority; that thereupon defendant sent the above-quoted telegram. Defendant contends that, in the telegram agreeing to accept draft for \$1,500, the telegram therein referred to and required to be attached was the Watertown telegram and was so meant by defendant and understood by both it and Pease; that, when the draft was presented and defendant saw that its telegram and not the Watertown telegram was attached, it refused to pay the draft.

Plaintiff's evidence was, and the court in its findings of fact so found, that the draft with the telegram attached was delivered to plaintiff on April 22, 1913, and the latter then became the owner thereof for value and has ever since been the owner thereof, and that at the time it was transferred to him plaintiff had no notice nor knowledge of any arrangement between the drawer and drawee of said draft not expressed in said draft and attached telegram, nor of any other telegram having any relation to or bearing upon the subject, and

that plaintiff did not take said draft possessed or charged with any such notice or knowledge.

According to Pease's testimony, there was no agreement over the telephone with defendant that he should attach any telegram from Watertown to the draft. His testimony is to the effect that the agreement of defendant to accept his draft was an independent agreement between them and that he depended on the telegram he received from defendant, as did plaintiff. The finding of facts makes no explicit finding as to whether or not the defendant meant any other telegram than the one that it sent and which was attached to the draft. It makes no specific declaration on that feature, and makes no finding in regard thereto any more than what may be implied in the finding that plaintiff had no notice nor knowledge of any such arrangement or situation. For all practical purposes, however, it may be assumed that there may have been some such agreement between defendant and Pease, and that the telegram meant, in the telegram agreeing to accept, was a telegram from Watertown; and the case will be disposed of on the theory that such may have been the case.

The questions, whether plaintiff became the owner, for value, of the draft, and whether he had or did not have notice of any arrangement between Pease and defendant as to any other telegram, or that any telegram, other than the one attached, was meant in the telegram of acceptance, were all questions for the trier of fact to determine, and his conclusion thereon is binding. Indeed, there is no evidence to the contrary, on the questions of plaintiff having given full value for the draft and that he was without notice of anything wrong in reference to the telegram referred to. So that, unless defendant's telegram of acceptance must be held to be a conditional acceptance, plaintiff is entitled to recover under the findings of the court, which also include a finding that at no time since April 22, 1913, has Pease's indebtedness to plaintiff been less than \$1,500. Of course, if the de-

fendant's telegram is a conditional acceptance, then plaintiff cannot recover unless he shows he complied with the condition. *Ford vs. Angelrodt*, 37 Mo. 50, 88 Am. Dec. 174. Section 10105, R. S. Mo. 1909, says:

"An unconditional promise in writing to accept a bill before it is drawn is deemed an actual acceptance in favor of every person who, upon the face thereof, receives the bill for value."

The vital question in the case, therefore, is whether said telegram is an unconditional acceptance. We think it was. When the draft with the telegram attached was delivered to plaintiff, where was any condition expressed upon which defendant's acceptance depended? The draft was accompanied by defendant's out-and-out promise to accept a draft of that precise amount and drawn by Pease. The words "telegram attached," in the acceptance, conveyed no intimation that any telegram other than the one sent was meant. These words did not create a condition of acceptance, but were merely a means of identification of the particular draft made pursuant to the acceptance. The attaching of the telegram would perhaps accomplish the further purpose of returning it to the acceptor so that its acceptance would not be out upon which other drafts could be drawn after acceptor had paid one. If this may be said to constitute, in a sense, a condition of acceptance, it is not such, within the meaning of the statute, as prevents the acceptance from being unconditional, so far as the plaintiff is concerned when he took the draft with the telegram attached. Payment by the acceptor was not "dependent on the fulfillment of a condition therein stated" as is required in the statutory definition of a conditional acceptance. Section 10111, R. S. Mo. 1909.

The evidence shows that the draft, upon being dishonored, was promptly protested, and this evidence was admitted without objection, and the absence from the petition of a specific allegation of protest cannot affect the judgment. The petition alleged that

payment of the draft was demanded of defendant on the 24th of April, 1913, and payment refused. Defendant's evidence showed that due presentment of the draft, and demand for payment, was made, and that it was formally done by a notary. Since the suit is against defendant upon its written acceptance of the draft, it is somewhat difficult to see what figure protest, after presentment and demand, would cut. There are no rights of drawer or indorsers involved, which would be discharged in the absence of protest, as provided by section 10122.

After payment on the draft was refused, plaintiff took a note from Pease for \$1,500 with his wife thereon, to secure Pease's liability as an indorser of the draft in question. We are unable to see how the taking of such a note released defendant of its liability to plaintiff on the acceptance. Pease's liability as an indorser was secondary; that is, he was not required to repay plaintiff anything on account of the indorsement of the draft unless defendant finally failed to pay it. Or, to state it the other way, plaintiff was not compelled to look first to Pease for his money on the draft instead of to defendant. He could look to the latter first. There is no evidence that Pease has repaid plaintiff the money he was out on the draft. And there is evidence, and the court so found, that Pease's indebtedness to plaintiff has never been less than \$1,500 since the date the draft was taken. Since plaintiff had the right to, and did, treat defendant's obligation on the acceptance as primary, the question of plaintiff's other transactions was not material, though the court (trying the case without a jury) admitted testimony as to them in order perhaps to understand and get at the whole story. There is also evidence that Pease has not been in a position to pay his obligations since the draft was made. If Pease, by wrongfully substituting a different telegram from the one intended, obtained money which defendant has to pay and to which Pease was not entitled, then Pease may be liable to defendant therefor; but defendant, having accepted the

draft and having induced plaintiff to advance his money on the strength of that acceptance, cannot compel plaintiff to look to Pease as his primary debtor in the draft transaction.

Finding no error in the case at least none that can be remedied by an appellate court, the judgment must be affirmed. It is so ordered. All concur.

193 S. W. Rep. 961.



Presentment For Payment

NEW YORK

Diligence—Liability of Endorser—Evidence

Supreme Court New York, Appellate Term
First Department, March 8, 1917

COHEN VS. CHELSEA EXCHANGE BANK

In an action by a depositor against his bank, evidence held not to show that the bank had exercised reasonable diligence to present to the maker a note indorsed to it by the depositor, so as to be excused from actual presentment under Negotiable Instruments Law (Consol. Laws, c. 38), section 142, and therefore not to entitle the bank to charge the indorser's account with the amount of the note.

Action by Morris J. Cohen against the Chelsea Exchange Bank of the City of New York. Judgment for defendant, and plaintiff appeals. Reversed and judgment directed for plaintiff.

STATEMENT OF FACT AND OPINION

Mullan, J. In this action by a depositor against his bank for failure to pay a check drawn on his account for \$100.44, it appeared that the balance on defendant's books to plaintiff's credit on the day of presentment of the check was insufficient to meet it; but plaintiff claims that this balance had been reduced by \$100 through an erroneous charge by defendant. Some months prior to the making of the check, plaintiff, as holder and second indorser

of a note made by one Lesser, indorsed the note to defendant, who discounted it and credited plaintiff's account with the proceeds, \$98.58. There is considerable dispute as to what happened on the due day and thereafter, but it is not in dispute that the note was not presented for payment, that it was not paid on the due day, and that defendant charged plaintiff's account with the amount thereof, \$100, subsequently crediting him with \$20 received on account from the maker.

Defendant contends that actual presentment was excused by the exercise of reasonable diligence to find Lesser at the place of payment on the due day. The story of defendant's messenger was that on the morning of the due day he went to the place of payment, which was a brick building, consisting of a ground floor, on which a restaurant was located, and at least two upper floors; that he thought he saw a letter box in the hall, but did not remember whether it bore a name or not; that he looked around in the hall for Lesser's name, and, not finding it, inquired for Lesser of some one in the restaurant without success; that he then started upstairs, but, being told by a man coming down that he did not know of any one there named Lesser, went out of the building without having entered any of the rooms upstairs; that he looked up to see if the name appeared on any window; and that, not finding Lesser's name on a window, he abandoned the search. Such was the full extent of his inquiry. It was established by undisputed and unimpeached testimony on the part of the plaintiff that Lesser was an occupant of the building at the time, and had been such for over three years; that he had a letter box there, marked "Star Braid Co., Max J. Lesser;" that there were only five occupants of the building; that Lesser actually had ready at the place of payment, on the due day, a certified check to meet the note. We do not think that the messenger's efforts constituted that reasonable diligence which legally excuses actual presentment. Section 142, negotiable instruments law. Defendant, therefore,

having failed to bind plaintiff, could not rightfully charge his account with the amount of the note.

Judgment reversed, with \$30 costs to appellant, and judgment directed in favor of plaintiff for \$100.44, with interest and appropriate costs in the court below. All concur.

164 N. Y. Supp. 75.



Money Paid Under Mistake of Fact

NEW YORK

*Payment in Due Course—Subrogation
—Indorser—Recovery*

New York Court of Appeals, February 27, 1917.

PITTSBURGH-WESTMORELAND COAL CO. VS. KERR.

Money paid on a negotiable instrument under a mistake of fact may be recovered back, however negligent the payor may have been, unless the payment has caused a change in the position of the other party so that it would be unjust to require him to refund.

Action by the Pittsburgh-Westmoreland Coal Co. against John K. Kerr, Mary Kerr Cole, and another, as administrators with the will annexed of William B. Kerr deceased, and others. Judgment for the plaintiff was affirmed by the Appellate Division (171 App. Div. 887, 155 N. Y. Supp. 1135), and the administrators appeal. Affirmed. (See, also, 135 N. Y. Supp. 1088.)

STATEMENT OF FACT AND OPINION

Chase, J. This action is brought to subrogate the plaintiff to the right which the Third National Bank of Buffalo had in a certain promissory note on the 23rd day of October, 1911, and to recover judgment for the amount of said note, interest, and protest fees.

The doctrine of subrogation is a device to promote justice. We shall never handle it unwisely if that purpose controls the effort and the resultant equity

is steadily kept in view. *Acer vs. Hotchkiss*, 97 N. Y. 395.

On October 23, 1911, the bank was the owner of a promissory note of \$2,500 made by one John K. Kerr and indorsed for his accommodation by his uncle, William B. Kerr. It was due that day at said bank, but was not paid. It was duly presented for payment, and payment refused, whereupon it was duly protested for nonpayment, of all which the indorser had due notice.

Prior thereto the maker of the note had entered into a contract in writing with the plaintiff, by which contract the plaintiff had agreed to furnish for him, and ship to a corporation in Canada, certain coal upon a credit of thirty days, to apply upon a contract which the maker of the note then had with said corporation. It was by said contract agreed, and the maker of said note did "therein and thereby sell, assign, and transfer unto the plaintiff his interest in and to his aforesaid contract with the Canada Iron Corporation, Ltd., as collateral security for the payment of the said indebtedness, and did promise and agree that the indebtedness thus transferred should be collected by him as agent for the plaintiff and that all funds received in that way should be deposited by the defendant John K. Kerr in a bank and that he would thereupon and immediately thereafter send to the plaintiff a draft in full settlement of the purchase price of such coal."

The plaintiff in September, 1911, in accordance with the terms of said contract, delivered to said corporation coal, for which, pursuant to its agreement with the maker of said note, it agreed to pay \$6,241.07. It gave its promissory note therefor payable to the order of John K. Kerr. On October 24, 1911, John K. Kerr transferred said note of \$6,241.07 to the Third National Bank and placed the proceeds thereof to his account. Under the agreement it then became his duty to obtain and send to the plaintiff a draft for \$6,099.22, but instead of doing so he obtained from said proceeds and sent to the plaintiff a draft for \$3,500, and wrongfully and

unlawfully converted the balance of \$2,599.22 to his own use and from said amount paid to the bank the amount due on said note of \$2,500 and destroyed the same. Three days thereafter, the indorser of said \$2,500 note died, and seven days thereafter the maker of the said note entered into voluntary bankruptcy. The note having been paid by the wrongful and unlawful application of plaintiff's money, it seeks to be subrogated to the rights of the bank as they existed immediately prior to such unlawful and wrongful application of its money.

When the plaintiff's money to an amount equal to the sum due on the note in question was transferred to the bank and John K. Kerr thereby obtained possession of the note and destroyed it, the note was in form paid, and canceled, but it was not in equity and justice a "payment in due course by or on behalf of the principal debtor" within the meaning of section 200 of the Negotiable Instruments Law (Cons. Laws, c. 38).

One cannot make himself the creditor of another by the unsolicited payment of his debts. *Kelly vs. Lindsey*, 7 Gray (Mass.) 287; *Homestead Co. vs. Valley R. R.*, 17 Wall. 153, 167; *Title Guaranty & Trust Co. vs. Haven*, 196 N. Y. 487; *Nassau Bank vs. National Bank of Newburgh*, 32 App. Div. 268.

It may be assumed that ordinarily money, although obtained by fraud or felony, cannot be recovered when it has been paid to the creditors of the party who has thus criminally obtained it even when the only consideration for the payment was the satisfaction of an antecedent debt. *Nassau Bank vs. National Bank of Newburgh*, *supra*; *Stephens vs. Board of Education*, 79 N. Y. 183; *Justh vs. National Bank of Commonwealth*, 56 N. Y. 478; *Hatch vs. Fourth National Bank*, 147 N. Y. 184.

Where, however, a payment with the money of another, wrongfully obtained, operates to discharge a lien (*Title Guaranty & Trust Co. vs. Haven*, *supra*; *Title Guaranty & Trust Co. vs. Haven*, 214 N. Y. 468), or a debt that is secured

by collateral, or as in this case by the indorsement of another, the debt may in equity be deemed alive for the benefit of the person whose money was so wrongfully used by the debtor, and such person may be subrogated to the rights of the one who owned the debt and the debt be deemed transferred and assigned to such person. The rule stated is founded in equity. Because it is equitable, it is enforced by the courts at all times unless there are surrounding circumstances and intervening equities that require a different conclusion. The following authorities, among others, sustain the principle upon which the rule is founded: Title Guaranty & Trust Co. vs. Haven, 196 N. Y. 487; Pomeroy's Equity Jurisprudence (2d Ed.) Secs. 1211, 1419, note; Markillie vs. Allen, 120 Mich. 360; Brannen vs. Union Stock Yards Bank of Buffalo, 215 N. Y. 652; Tobin vs. Kirk, 73 Hun, 229; Mississippi & M. G. S. Canal Co. vs. Noyes, 25 La. Ann. 62; Newell vs. Hadley, 206 Mass. 335; Barron vs. White-side, 89 Md. 448; Coulter vs. Minion, 139 Mich. 200; Mayer vs. McCracken, 245 Ill. 551; Boice vs. Conover, 69 N. J. Eq. 580, 61 Atl. 159; Webber vs. Hausler, 77 Minn. 48; Young vs. Picos County, 46 Tex. Civ. App. 319; Farmers' Loan & Trust Co. vs. Detroit, B. C. & R. R. Co. (C. C.) 71 Fed. 29; Aller Co. vs. Ries, 164 Mich. 501.

The recovery of a money judgment in the action is merely incidental to the subrogation.

When converted securities or their avails can be traced into an account or property owned by the wrongdoer, the owner may follow them and recover the same or their value. Hatch vs. Fourth National Bank, *supra*.

The right of subrogation or of equitable assignment is not founded upon contract nor upon the absence of contract, but is founded upon the facts and circumstances of a particular case and upon principles of natural justice, and generally where it is equitable that a person furnishing money to pay a debt should be substituted for the creditor or in place of a creditor such person

will be so substituted. Crippen vs. Chappel, 35 Kan. 495, 11 Pac. 453.

In Pease vs. Egan, 131 N. Y. 262, 272, 30 N. E. 102, 104, this court, speaking of subrogation, says:

"No contract is necessary upon which to base the right, for it is founded upon principles of equity and benevolence and may be decreed where no contract exists. * * * It was said by Chief Justice Marshall that equity would clothe the party thus paying with the legal garb with which the contract he has discharged was invested, and it would substitute the party paying to every equitable interest and purpose, in the place of the creditor whose debt he has discharged."

According to the well-established principles upon which the doctrine of equitable assignment by subrogation rests, if the person paying stands in such a relation to the premises that his interest, whether legal or equitable, cannot otherwise be adequately protected, the transaction will be treated in equity as an assignment. The remedy of subrogation is no longer limited to sureties and quasi sureties, but includes so wide a range of subjects that it has been called the "mode which equity adopts to compel the ultimate payment of a debt by one who in justice, equity, and good conscience ought to pay it." Where within the limits suggested benefit may result to the person paying without injury to the person who should pay, equity casts the burden upon the latter, who ought in fairness to bear it, provided it will not work injustice or disturb the rights of other creditors of a common debtor. Arnold vs. Green, 116 N. Y. 566.

In Dunlop vs. James, 174 N. Y. 411, the court say:

"In modern times courts of law have dealt with subrogation as they would with assignments, and, when the right of action to which the plaintiff asks to be subrogated is a legal right of action, a court of law may treat a plaintiff who is entitled in equity to subrogation as an assignee, and allow him to maintain an action of a legal nature upon the

right to which he claims to be subrogated."

Speaking of subrogation, it is said in *Stevens vs. King*, 84 Me. 291:

"It ignores the form and looks to the substance" which treats "payment to be purchase and purchase to be payment, as justice may demand. It substitutes one person for another or property for property."

One who intrusts money to an agent to be invested in land and whose agent fraudulently used the money to pay off a mortgage on lands may, on discovering the fraud, be subrogated to the rights of the mortgagee. *Cotton vs. Dacey* (C. C.) 61 Fed. 481.

The remedy of subrogation is governed by principles analogous to those that govern actions to recover money paid by mistake. Money paid on a negotiable instrument under a mistake of fact may be recovered back, however negligent the party paying may have been in making the mistake, unless the payment has caused such a change in the position of the other party that it would be unjust to require him to refund. *Hathaway vs. County of Delaware*, 185 N. Y. 368; *Irving Bank vs. Wetherald*, 36 N. Y. 335; *Mt. Morris Bank vs. Twenty-Third Ward Bank*, 172 N. Y. 244; *Continental Bank of N. Y. vs. Tradesmen's National Bank of N. Y.*, 173 N. Y. 272; *Allen vs. Fourth National Bank of N. Y.*, 59 N. Y. 12; *United States vs. National Ex. Bank*, 214 U. S. 302.

From the findings of the Special Term in this case, unanimously affirmed by the Appellate Division, it not only appears that when the maker of the note paid the same with the plaintiff's money he was insolvent, but that the indorser's liability on the note had at that time become fixed by demand and notice. The indorser was, then, as to the bank, a principal debtor. *First National Bank of Buffalo vs. Wood*, 71 N. Y. 405; *German American Bank of Buffalo vs. Niagara Cycle F. Co.*, 13 App. Div. 450; *Negotiable Instruments Law*, Sec. 144.

It is conceded that the plaintiff on

October 24, 1911, was not in any way interested in the \$2,500 note nor obligated to pay it. In making John K. Kerr its agent in connection with the contract for the sale of its coal, it was not so far as appears negligent. It was an ordinary business transaction. Neither was there any fraud or connivance on the part of the plaintiff in the payment by John K. Kerr of the note from its money. It was wholly unauthorized. The equity in favor of the plaintiff is not affected because of its misplaced confidence in John K. Kerr.

Although the plaintiff was without fault in connection with the transaction, nevertheless its money was diverted and unlawfully used by the maker to get possession of the note. It does not appear from the findings that there has since been any intervening equity in favor of the appellants. The appellants' effort to obtain such a finding was met with a refusal on the part of the court. No laches of the plaintiff interferes with its equitable right. Not only was there but three days' time intervening between the conversion of the plaintiff's money and William B. Kerr's death, and but seven days to John K. Kerr's bankruptcy, but even if John K. Kerr had not converted plaintiff's money to get possession of the note, and in that short interval payment could have been obtained by William B. Kerr from the maker of the note, his (the maker's) bankruptcy would have constituted such a payment an unlawful preference among his creditors which the bankruptcy court would have annulled and set aside. *Matter of Christopher Bailey & Son* (D. C.) 166 Fed. 982.

It further appears from the findings that dividends have been paid from the assets of the bankrupt maker upon the amount diverted from the plaintiff and such dividends have been credited thereon. William B. Kerr, as we have seen, died October 27, 1911. His will was proven November 18, 1911. John K. Kerr became a bankrupt November 1, 1911. This action was commenced January 17, 1912, although the appel-

lants were not served until some weeks thereafter.

All of the facts and circumstances show that the appellants have not been injured by what has occurred. There is nothing that in any way interferes or affects the simple question whether, under the circumstances disclosed, the note should be considered alive and equitably assigned to the plaintiff, that the maker and the appellants may be held thereon for the benefit of the plaintiff.

If this action is not sustained, the appellants will secure the discharge of their testator's obligation on the note through a payment from the plaintiff's money by fraud on the part of the maker of the note and without payment on their part or any equity in any way affecting the question under consideration. If such an inequitable result is sustained, the court must acknowledge its impotence to prevent wrong and enforce justice. *Title Guarantee & Trust Co. vs. Haven*, 214 N. Y. 468.

As the maker of the note wrongfully and unlawfully used plaintiff's money to obtain possession of it, he is estopped from claiming that it was paid. Even if as to the bank the note was paid by one of two persons primarily liable thereon, neither of the persons so primarily liable to the bank are in a position in equity to claim that the note has been paid.

Plaintiff's recovery may also under all the circumstances disclosed be sustained upon the general theory that, where negotiable securities are stolen or obtained through fraud, the owner may follow and claim them or the proceeds thereof in the hands of the felonious taker or in any other hands to which they had been transferred unless intervening equities interfere. *Newton vs. Porter*, 69 N. Y. 133.

The appellants principally rely upon the decisions in *Lancey vs. Clark*, 64 N. Y. 209, 212, and *Eastman vs. Plumer*, 32 N. H. 238, to support their contention. In the *Lancey* case, the plaintiff furnished the money to one of the members of a firm for whose benefit a note had been given, with which to take it

up from the holder thereof. It was held that the plaintiff did not derive any right to the note by transfer from the holder, but from the party primarily liable by payment at his request. The question under consideration in that case was one as to the intention of the parties when the amount of the note was paid to the holder thereof. On the facts before the court it was said in the opinion:

"All the bank did in this case was to take payment of the note, and deliver it up to a party paying and liable to pay, after protesting it, so that he could make such use of it as the law and the facts would authorize. It did not transfer or intend to transfer it. The plaintiff, therefore, took no title to it from the bank, but he took it from Lincoln, and cannot therefore enforce it against the defendant."

In the *Eastman* case, a note had been made payable to order and indorsed in blank. The principal signer on the note, being called on for payment, brought the money and paid it over to the holder, who received it as and for payment and gave up the note to the principal. The money paid in fact belonged to a third person who sent the principal to purchase it as his agent. Held, in an action brought by the owner of the money against the surety on the note, that the note as to the surety was paid and that the action could not be maintained.

The question of fraud, mistake, or equity or the right to an equitable assignment or subrogation does not appear to have been discussed or claimed by counsel or considered by the court in either of these cases. The decisions therein, particularly in view of the fact that the rule as to an equitable assignment or subrogation was not claimed or considered, are not sufficient to prevent the application of the rule in equity relating to an assignment or subrogation for the purpose of doing justice as herein stated.

The judgment should be affirmed, with costs.

115 N. E. Rep. 465.

“Book Value”

NORTH DAKOTA

Valuation of Bank Stock

Supreme Court North Dakota, March 17,
1917.

ELHARD VS. ROTT.

The “book value” of the capital stock of a banking corporation is reached by extending all the assets as they appear on the corporate books, and deducting all the liabilities and other matters required to be deducted, and taking the balance as a measure of value. The books are all of the books of the bank and are not merely the ledger, and when part of the assets are promissory notes bearing interest, the accrued interest on such notes will be computed, even though such notes are not yet due (citing Words and Phrases, Second Series, Book Value).

Action by George Elhard against Fred Rott for the specific performance of a contract for the sale of corporate stock. Judgment for defendant and plaintiff appeals. Affirmed.

STATEMENT OF FACT AND OPINION

Bruce, C. J. This is an action for the specific performance of a contract to sell bank stock. The defendant had agreed to sell the plaintiff the stock in question at its “book value” at the time of the purchase, and the only question which we need to consider is the meaning of the term “book value.” In arriving at the book value of the stock, was it necessary to compute the accrued interest on the notes which were held by the bank, even though such notes were not due? And did the books include all of the books of the bank, or merely the ledger? In other words, should a note for \$500 which drew ten per cent. interest and was due six months from date be figured merely at its face value if only three months had run since the note was executed, or, in estimating its value, should the accrued interest for the three months be taken into consideration? The learned trial court held that in view of all the circumstances, the parties intended that in arriving at the book value of the stock

such interest should be taken into consideration. We are satisfied that he was justified in this conclusion. We believe, indeed, that the term “book value” has an established meaning in so far as the capital stock of a banking corporation is concerned. It means value as predicated on the face value of the assets of the corporation after deducting its liabilities. *Steeg vs. Leopold Bldg. & Imp. Co.*, 126 La. 101; *Cabble vs. Cabble*, 111 App. Div. 426; 1 Words and Phrases (Second Series) 479. The assets, of course, must appear upon the books of the company, and must be able to be estimated therefrom, but it does not follow that the computation must have been made on such books and appear on the ledger. The book value of stock is determined by the face value of the assets as they appear upon the books. The bills receivable of every bank contain not merely the record of the notes and of the face value of the principal thereof, but of the interest which they draw and the dates of their making and maturity. If these notes were sold or discounted, it is very clear that the interest already earned would be taken into consideration. A note, for instance, of \$500, which draws interest at the rate of ten per cent., and which has run for three months, is surely worth more than its face value of \$500, even though it has some three months yet to run before it reaches maturity and the interest can be collected. This conclusion disposes of the case, and the other questions raised need not be considered.

The judgment of the district court is affirmed.

102 N. W. Rep. 202.



Travelers' Checks

NEW YORK

Forgery—Liability—Indemnity Bond
Court of Appeals, New York, February 27,
1917.

SULLIVAN VS. KNAUTH ET AL.

A banker agreeing to pay travelers' checks upon the holder signing his name was liable

for their face value after cashing them upon a forged indorsement; a provision requiring an indemnity bond before recovery if the checks were lost being inapplicable.

Action by James Sullivan against Wilhelm Knauth and others. From an order of the Supreme Court, Appellate Division (161 App. Div. 148, 146 N. Y. Supp. 583), reversing an order of the Appellate Term which had reversed a judgment of the Municipal Court for plaintiff, the defendants appeal by permission. Affirmed.

STATEMENT OF FACT AND OPINION

Hogan, J. The plaintiff, by occupation a miner, in the fall of 1911 contemplated a trip to San Francisco and Lima, Peru. He called at the Lyon County National Bank at Yerington, Nev., and asked for Wells Fargo travelers' checks. An officer of the bank recommended to him travelers' checks issued by defendants, and he thereupon purchased seven checks, four for \$100 each, three for \$50 each and paid therefor \$550. Three of the checks, two for \$100 each and one for \$50, are involved in the present action. The following is a copy of one of the checks:

"K. N. & K. Traveler's Checks Nos. S. 4,021-01, \$100.00.

"Sold by Lyon County Bank,

"New York (Date) Yerington, Nev.

"Holder's Signature.

"Good within one year from date when countersigned below with the opposite signature: JAMES SULLIVAN.

"Knauth, Nachod & Kuhne, New York, through their correspondents will pay against this check out of their balance to the order of T. P. Bingham é Hijos one hundred dollars or equivalent as follows:

"In U. S. and Canada \$100.00; England, Ireland, Scotland, £20.8.2; France, Belgium, Switzerland, Francs, 512.50; Germany, M. 416.60; Italy, Lira, 512.50; Sweden, Norway, Denmark, Kronor, 366.98; Holland, Florins,

245.10; Austria, Kronen, 490.20; Russia, Rubles, 192.30; other countries at current rates.

"Knauth, Nachod & Kuhne.

"Countersign here:

"James Sullivan.

"This signature must correspond with above."

At the end:

"Knauth, Nachod & Kuhne, New York.

"Checks negotiated in Europe will be paid only through European correspondents. [Then followed a list of such correspondents.] And all other correspondents as per official list."

The foregoing check was indorsed by T. P. Bingham é Hijos to the order of Cortes Commercial and Banking Company, Limited, then by the latter to the order of G. Amsinck & Co., and by Amsinck & Co. to the Bank of New York, N. B. A., or order. Immediately following appears:

"Received payment November 14, 1911. The Bank of New York National Banking Association, Charles Olney, Cashier."

The two remaining checks, one for \$100, one for \$50, were in like form, save that the payee in each check was Castellon & Lacayo, L'd'a., were each indorsed by the payee and others, and were finally paid through the Bank of New York and indorsed by the latter in the same manner as the first check. Four of the seven checks purchased by plaintiff had been cashed by him. The three checks above referred to were produced by the defendants upon the trial.

At the time plaintiff purchased the seven checks at the bank in Yerington he signed his name "James Sullivan" on each one of the checks under the words "Holder's Signature" engraved thereon, in the presence of an officer of the bank. The checks which he personally had cashed were countersigned by him where indicated by the words "Countersign here." The three remaining checks hereinbefore specifically referred to were not countersigned by him. His

name appearing thereon was a forgery, and such issue was not controverted by defendants upon the trial.

The evidence of plaintiff tended to show that he took passage on the steamship San Juan at San Francisco for Ancon, Panama. On October 15, 1911, when near Corinto, Nicaragua, he discovered that the three checks which had not been countersigned by him had been lost or stolen while he was on the boat. He endeavored to find the checks, and offered a reward for the return of the same. By reason of a quarantine at Corinto because of yellow fever he was not permitted to go ashore at that port. Upon his arrival at Panama he gave notice of the loss of the checks to a man who conducted a small bank and general store, upon which place of business was a sign inscribed "Knauth, Nachod & Kuhne," and was told by that man that he would stop payment of the checks. He also gave notice to three banks at Panama to stop payment of the checks. He testified that he did not know the numbers of the lost or stolen checks or the address of defendants, as the same was lost or stolen with the checks; that he did not send direct notice to New York, and the first opportunity afforded him to give any notice was upon his arrival at Panama.

From Panama plaintiff went to Peru, and later, and about December 21, 1911, returned upon a sailing vessel to the United States. Since his return he has resided at Portland, Ore. December 29, 1911, the Lyon County Bank at Yerington, Nev., addressed a letter to defendants and inclosed therewith a letter received by it from the plaintiff. In the letter written by the bank appeared the following:

[The letter inclosed] "is self-explanatory. We have written him to take the matter up with you. You will please stop payment on the checks as per his request. * * *"

The receipt of that letter was acknowledged by defendants January 3, 1912.

On behalf of defendants evidence was offered to the effect that the letter was received by them from the bank at Yer-

ington was the first notice they had that the checks which had been paid about one month previous thereto were not presented by a holder in due course; that defendants did not have an agent at Panama, though they had some 3,000 correspondents in their business of travelers' checks. Plaintiff having testified that at the time of the purchase of the checks a book with a red cover was delivered to him which he described as a "European directory of that firm, I believe," upon cross-examination he testified:

"Upon the cover of the book given me was printed: 'We refund the amount of lost checks against execution of a suitable bond of indemnity. Particulars of such checks should, however, be promptly reported.'"

Evidence offered by defendants tended to show that defendants issued two books, one a red-covered book for foreign use, the second one a brown-covered book for domestic use, also a folder. Counsel were permitted on the trial to read in evidence from the books and folder as follows:

"If you have already traveled extensively, you probably know the difficulties which, at times, arise in regard to arrangements for carrying money. Then, you will appreciate the safety, economy and convenience of our letters of credit and travelers' checks. If this is your first long trip, we can assure you that the various facilities which we offer will prove equal if not superior to those provided by any other system."

"In case of loss, the amount of checks will be refunded, or a new supply furnished in their stead, upon execution of a satisfactory bond of indemnity. The numbers of the checks lost and the circumstances attending the loss should, however, be at once communicated to Messrs. Knauth, Nachod & Kuhne, Leipzig, Germany, if lost abroad, or to Knauth, Nachod & Kuhne, New York, if lost in America, so as to enable them to do whatever is possible under the circumstances."

"We sell travelers' checks for a commission of one-half of one per cent., and

guaranty payment of the face amount, less stamp tax, if any. * * *

"In order to insure himself against loss, the traveler is required at the time of purchase to sign his name to the checks in the space reserved for 'holder's signature.' Our travelers' checks cannot be cashed unless they are countersigned, and then only in 'holder's signature' and 'countersignature' correspond. Wrongful holders would find it difficult to commit forgery as the countersignature is to be affixed to the checks in the presence of our correspondents."

"We wish to call attention to the fact that the countersignature should be affixed to the checks only in the presence of the person to whom they are presented for payment. Checks already countersigned can only be cashed with difficulty and, in case of loss, they are open to misuse."

The Lyon County National Bank had in its possession engraved checks signed by the defendants. The amount payable on each check was engraved thereon. The bank was authorized to fill in the date on the checks, write or stamp thereon the name of the bank as the seller thereof, to receive the cash therefor, and after the purchaser had signed his name to each check in the presence of an officer of the bank in the space upon the checks reserved for "holder's signature" to deliver the checks. The defendants had delivered to the bank literature issued by them from which quotations have been made to be distributed to purchasers of checks. The Yerington bank in the transaction at bar followed the procedure dictated by defendants, presumably the same course adopted with their numerous correspondents and at their home office in the city of New York. Clearly the Lyon County National Bank at Yerington, Nev., was the agent of defendants. As such agent it received from the plaintiff \$550 for defendants, not as a deposit or for safekeeping, but upon a contract wherein defendants undertook that they would within one year from the date of the checks, when countersigned below (where the words "Countersign here" appeared) with the oppo-

site signature (i. e., the original signature of plaintiff subscribed in the presence of defendant's agent under the heading "Holder's signature"), pay the amount stated in the check to the order of the payee therein named. The contract of defendants was prepared by them. In their literature they referred to the safety, economy, and convenience of their traveler's checks; that they sold such checks for a commission of one-half of one per cent. and guaranteed payment of the face amount of same; they required the purchaser to place his signature in the space reserved for that purpose. Upon the face of the check they provided a means of protection to themselves and their correspondents; for thereupon was the holder's handwriting for comparison with the countersignature which was to be affixed in the presence of the person to whom the check was presented for payment. While the requirement of a countersignature on the check was some protection to the purchaser of the same, it was a primary protection to defendants, as their promise to pay arose when the check was countersigned "below with the opposite (genuine) signature, which must correspond with the above signature," not the above name. The checks countersigned by the plaintiff in his handwriting before he left San Francisco were paid by defendants. They had his genuine countersignature in their possession for some time before the checks in question were paid; consequently they had additional means of identification of signatures. They paid the three checks in question upon a forged simulation of plaintiff's signature, rather than when the checks were countersigned with the "opposite signature," the genuine signature of the purchaser inscribed on the same, and thereupon breached their agreement.

Defendants were not entitled to defend the action on the ground that plaintiff had failed to give them a bond of indemnity. The checks are not lost; they are in the possession of defendants, and were produced by them upon the trial of the action. While defendants asserted that the checks had been

paid, they did not undertake to question the evidence offered by plaintiff that his name appearing thereon as a counter-signature was a forgery. After full consideration of all propositions argued by counsel for appellants, we conclude that the order of the Appellate Division was right, and should be affirmed with costs.

McLaughlin, J. (concurring). I concur in the conclusion reached by Judge Hogan on the ground that when the defendants paid the checks here in question, without the same having been countersigned by the plaintiff, it was a

breach of contract which entitled him to recover the amount thus paid. The defendants expressly agreed that they would not cash such checks unless they were thus countersigned. They never were countersigned by the plaintiff, and when the defendants paid them the plaintiff had an immediate cause of action to recover the damages sustained, which were the amount of the checks, together with interest from the time the demand was made by him upon the defendants for payment. *Samberg vs. American Express Co.*, 136 Mich. 639. 115 N. W. Rep. 460.



Amendment of the Federal Reserve Act

THE Comptroller of the Currency has sent to all national banks throughout the country the following announcement:

The President has signed the amendment to the Federal Reserve Act changing reserve requirements of national banks. From this date the law requires all national banks in central reserve cities to maintain in their respective Federal Reserve banks a balance of thirteen per cent. of demand deposits, banks in reserve cities a reserve of ten per cent. of demand deposits, and country banks a reserve of seven per cent. of demand deposits. National banks in central reserve cities, reserve cities and also country banks will be required to keep a reserve on their time deposits of three per cent. with their reserve banks, instead of the five per cent. reserve heretofore required. National banks are not now required to keep reserve against Government deposits (exclusive of postal savings).

"The law does not require national banks to keep reserves other than those they are required to carry in their respective reserve banks, but each bank

will, of course, naturally arrange to carry in its own vault sufficient funds to meet its current cash requirements.

"The Federal Reserve Board has requested that national banks in central reserve cities bring their balances with their reserve banks up to the new requirements not later than the twenty-seventh instant.

"In order that the transfer of increased balances to the Federal Reserve banks by country banks and reserve city banks may be made with the least inconvenience, the Federal Reserve Board has suggested that if the reserve increases required under the new law are provided by reserve city banks and country banks not later than July 15, and the reserves carried with the Federal Reserve banks are maintained meanwhile at not less than the percentage heretofore required, the Federal Reserve banks may omit for this intervening period the imposition of penalties, for reserve deficiencies, against those national banks which shall not before July 15 bring their reserve balances with their reserve banks up to the full percentage required by the new law."

Thrift Day; A Patriotic Duty

By ALLEN L. BECHTER, Pierce State Bank, Pierce, Nebraska

Copyright, 1917, Collins Publicity Service, Philadelphia, Pa.

[This essay was awarded the first prize in the Thrift Day Prize Contest conducted by the Collins Publicity Service.—EDITOR.]

THE enthusiastic response of the American people to the idea of a national Thrift Day, as evidenced by the results of its second annual observance on February 3, insures this worthy movement a secure place in the calendar of American holidays. No national movement in recent years has met with such hearty and spontaneous approval in so short a time by the people of our country.

Why has the Thrift Day idea been so eagerly adopted by all classes of our citizenship? Because for each and every individual thrift has its own peculiar appeal. It challenges the thought and attention of the manual laborer, the housewife and the business man. The average person of mature years can readily recognize the virtues of thrift, and it is easy enough to point out to others the rewards of its practice. What has been lacking in the past has been some definite plan which would crystallize the flux of vague and dilatory resolutions into stable and effective action. The institution of Thrift Day has supplied the necessary incentive. Misery loves company, and in the exertion of any act of self-sacrifice on February 3, there is no small consolation in the realization that countless other men are undergoing the same novel experience. And there is no telling in how many cases the practice of some act of denial, such as refraining from the after-dinner cigar, has proved such a boon to health, that it has been made the daily rule of conduct.

The real test of the efficacy of Thrift Day propaganda, however, lies in the

poignancy of its appeal to the children. It is all very well to tell youth how it must save in order to provide for a comfortable old age. The familiar tables showing how long it takes for a dollar



ALLEN L. BECHTER

Mr. Bechter was awarded first prize in the Thrift Day Prize Essay Contest recently organized by the Collins Publicity Service, Philadelphia, Pa. He is assistant cashier of the Pierce State Bank

to double itself at a stated rate of interest are interesting as mathematical facts. But a date ten to twenty years in the future is too far distant for a child to fathom. The founders of National Thrift Day realized that pleas for economical management must be associated with that more universally practiced virtue—patriotism.

Love of country is one of the earliest passions instilled in the child's mind and any movement which gives an opportu-

nity to show patriotism will command his respect. Setting aside one day each year to promote National Thrift will at once win his attention and the date will instinctively be placed in his list of national holidays—each of them marking some phase of our country's patriotic devotion.

Upon the support of the children depends the growth of the thrift movement. Habits of saving inculcated in the younger generation to-day will mean a nation of conservative grown-ups a few years hence. Briefly, then, the founders of Thrift Day have succeeded in giving to the prosaic subject of thrift a national and patriotic significance; and thus they have obtained the interest of the children, without whose co-operation the movement would be doomed to failure.

Having made such a good start it is necessary to keep constantly before them the patriotic qualities of thrift. France could never have met the huge indemnity laid upon it at the conclusion of the Franco-Prussian war had its citizenship not been taught to consider thrift as a patriotic duty. The resourcefulness of Germany and her ability to withstand enemies on every front for two and one-half years can be attributed largely to the economies which the Teu-

tons have practiced solely for love of the Fatherland. These examples of patriotic service must be impressed upon American citizens. Thrift should become synonymous with patriotism.

Bankers should recall the experiences of their own childhood, and then realize that nothing will cool the ardor of a youthful economist and prospective savings depositor quicker than a poorly-suppressed smile on the face of some thoughtless receiving teller. It should be the policy of every bank to meet the child more than half way by treating his case as one of the utmost business importance, and by congratulating him upon his initial efforts. Above all the child should be impressed with the fact that he has performed a patriotic service, and moreover that it is his duty to continue the exercise of thrift.

The community banker who will identify himself actively with the national thrift movement will not only rejoice in the satisfaction of a duty well done, but he will find out that his efforts have redounded to his own material benefit. Closely linked with patriotic impulses, National Thrift Day will take its rightful place in the hearts of the people as a day of realization for the elders and a day of inspiration for the children.



A Trade Acceptance Bureau

THE interest in the "Trade Acceptance" in substitution for the open account has so broadened of late that it was decided at a recent conference held by the National Association of Credit Men to establish a "Trade Acceptance Bureau" in the association's offices. The bureau will prepare and issue a series of leaflets covering such subjects as:

"What is the trade acceptance and why has discussion as to its adoption arisen at this time?"

"What forms of acceptance are approved by the Federal Reserve Board

and what technical points in form and manner of use are to be observed?"

"What are the advantages of the seller, and what to the buyer of merchandise presented by the trade acceptance system?"

"Establishing the acceptance policy in a concern and the preparation of forms and invoices and introductory matter for the presentation of the system to customers."

"Experience of concerns using the acceptance, with illustrations showing methods used to increase the number of accepting customers."

What One Bank Has Done to Help the Farmer*

THE Plymouth County Trust Company of Brockton, Mass., has tried to help the farmer apply business methods to the business of agriculture, believing that if the farmers are lax in their methods, the fault lies in part with the banker.

Acting upon this conception of the opportunity for community service the Plymouth County Trust Company for two years has employed two young graduates of the Massachusetts Agricultural College to study the needs of the farmers in Brockton and neighboring towns. The directors wanted to get acquainted with the farmers so as to make a business-like application of credits to those engaged in this important industry.

During the last two years our two agricultural representatives report:

Visits made	1,320
Office calls	656
Letters written	1,957
Meetings held	60
Miles traveled by auto.	20,000

As an incident to the work of the agricultural department the bank has brought into the city 22 cars of grain, 23 cars of hay, 258 head of cows, worth approximately \$40,000, two pure-bred bulls, distributed 569 pigs, exhibited 41 pigs and 7 cows at the Brockton Fair and two cows at the National Dairy Show at Springfield.

This department has also distributed twenty-eight high-grade heifers to boys and girls, organized three coöperative buying associations, supported a home economic adviser and a modern tenement in the Lithuanian district, where cooking lessons are given twice a week, and published a cook-book in Lithuanian, of which they have distributed one thousand copies.

They have planned a coöperative group for the mixing of fertilizers and

have sent out 500 letters describing the pedigree of the pure-bred bulls owned by the bank.

The Pig Club was one of its first activities and has proved a valuable educational work. The second year's membership was secured almost wholly by members of the previous year's club. The boys and girls assemble in a vacant lot in the city, where the pigs are distributed to them. They pay for them by notes with interest, which the bank accepts without other security.

Most of the pigs are taken home in bags. One of the interesting sights was over seventy-five girls and boys sitting on the sidewalk curb waiting for the distribution. One electric car going out of the city carried thirty-eight pigs and their owners.

A prize of \$100 was offered to the boy or girl producing the best result in pig raising, this money to be available only in case the winner should go to some agricultural college or domestic science school. In this way they have endeavored to stimulate a desire on the part of the child for an agricultural education.

The future of the boy who won the prize the first year has been wholly changed because of his success in the competition. He is going to an agricultural college and already has a small bank account to his credit for that purpose.

The Pig Club produced over 67,000 pounds of pork, with a market value of over \$9,000. The average profit per pig was \$6.58, making a total profit to the members of \$2,500.

The dairy project by its growth seems to prove its value. Of high-grade cattle brought in by this bank, fifteen are pure-bred, and a growing demand for such stock has been found.

*From a circular issued by the Massachusetts Committee on Public Safety.

One man with seven cows sold him by the bank, out of a total of thirteen in his herd, has the highest producing herd of grade cattle in the vicinity. Practically all who have kept records have made an average of over 10,000 pounds of milk per cow per year. The production in Massachusetts averages approximately 5,000 pounds. Two of these grade cows have given over eighty pounds of milk per day; several over seventy pounds. These records were seldom, if ever, obtained by the average farmer before the bank began distributing this class of stock.

For a long time farmers have been urged to buy better cows, use better feed, keep records, and to know whether or not each individual cow made or lost money. The bank helped to accomplish these results in many cases.

The bank now plans to purchase seeds and other farm supplies. It has already disposed of over 600 tons of seed potatoes which were brought directly from Maine to be distributed in small lots to those interested in the home garden project.

It had a market gardener (who is a graduate of the Massachusetts Agricultural College at Amherst) draw plans for a home garden, suggesting dates and varieties of vegetables, which, in his opinion, would be the best for this section.

It printed and distributed 4,000 of these "Garden Manuals" in the shoe factories of Brockton, holding meetings

at the noon hour, and addressed in this way over 2,000 men on the subject of home gardens.

The bank's market gardener is a young man to whom it advanced a credit of \$300 two years ago when he was starting his farm. Last year his net profit was \$2,000, and he has attributed his rapid advance to the help given him by the bank.

The fact that over two million dollars worth of food supplies were brought into Brockton alone in one year will show that there is need in this and other industrial centres for more food to be raised at home.

The bank is showing the farmer how to keep cost accounts and how to make out statements—in short, to know his business, both from the technical and from the business standpoint. Through this department every family is reached who may be or become interested in farming or home gardening. Whenever such persons are found worthy the bank is ready to make a small loan to be used for constructive work or for improvements, under the supervision of the bank's agents.

Every banker will ask himself—"Does it pay?" Yes, emphatically. It has cost the Plymouth County Trust Company about \$4,000 a year net to supply this service to the farmers in and about Brockton, but as a result of this and similar activities, the deposits have increased in the past five years from \$500,000 to over \$3,000,000.



Bringing the People Together

By WILLIAM A. LAW, President First National Bank, Philadelphia

THIS war will create a better understanding than ever before between all classes of our people. How can anyone appeal to the envy and class hatred of the masses against men of larger means who in this crisis are not only bearing more than their share of the cost of the war, but are sending their sons into the army, the navy and the aviation corps, while their daughters

are training as nurses and learning to perform other tasks of which they never before dreamed themselves capable? This common service will unite us and help us to understand each other's problems and teach us at the same time a broader economy and a higher efficiency. It will diffuse more generally the true spirit of democracy, and teach us the real values in men and in life.

Bank Advertising Exchange

Those listed herewith are willing to exchange booklets, folders and other advertising matter issued by them. Subscribers can get on this list free of charge

Watch for New Names and Other Changes

A

Adams, F. R., Will County National Bank, Joliet, Ill.
American National Bank, Richmond, Va.
Anley, D., c/o Central Trust Co., San Antonio, Tex.
Art, Carl W., manager publicity department, Union Trust Co., Spokane, Wash.

B

Bader, A. F., publicity manager, Old State National Bank, Evansville, Ind.
Bailey, C. W., cashier, Southern Trust Co., Clarksville, Tenn.
Bank of San Rafael, San Rafael, Cal.
Bankers Magazine, The, New York.
Baugher, E. M., president, The Home Building Association Co., Newark, O.
Beerbower, C. W., National Exchange Bank, Roanoke, Va.
Bickford, E. L., cashier, First National Bank, Napa, Cal.
Bollman, H. C., assistant cashier, First National Bank, Collinsville, Okla.
Branch, D. R., 6252 Leland Way, Los Angeles, Cal.
Brannen, Jesse E., cashier, First National Bank, Westwood, N. J.
Brooks, T. J., cashier, The Guaranty Trust and Savings Bank, Jacksonville, Fla.
Brown, R. A., assistant cashier, Citizens National Bank, Raleigh, N. C.
Bunch, F. E., cashier, Merchants and Farmers Bank, Statesville, N. C.
Burton, E. C., vice-president, Penn. National Bank, Chester, Pa.
Burwell, Stephen L., vice-president, First National Bank, Jackson, Miss.
Bush, A., Jr., Ladd & Bush, bankers, Salem, Ore.

C

Citizens Bank and Trust Co., Tampa, Fla.
Citizens National Bank, Oconto, Wis.
Commercial Bank, Midway, Ken.
Copp, H. Reed, assistant advertising manager, National City Bank, New York City.
Cory, Arthur S., Chehalls National Bank, Chehalls, Wash.
Craig, David, Tradesmen's National Bank, Philadelphia, Pa.
Critchell, L. S., publicity manager, Guaranty Trust Co., New York City.
Crowson, M. Clarence, cashier, Home Banking Co., High Point, N. C.
Culbreth, Eugene E., Commercial National Bank, Raleigh, N. C.
Currey, Bradley, c/o Fourth and First National Bank, Nashville, Tenn.

D

Dalby, H. A., Naugatuck Savings Bank, Naugatuck, Conn.
Davenport, C. M., manager new business department, Bank of Italy, Los Angeles, Cal.
Dexter Horton National Bank, Seattle, Wash.
Durham, T. R., assistant cashier, Chattanooga Savings Bank, Chattanooga, Tenn.
Dysart, W. R., assistant cashier, First National Bank, Ripon, Wis.

E

Eherspracher, J. C., assistant cashier, First National Bank, Shelbyville, Ill.
Ekirch, A. A., secretary, North Side Savings Bank, New York City.
Ellsworth, F. W., secretary, Guaranty Trust Co., New York City.

F

Finch, E. W., assistant cashier, Birmingham Trust and Savings Co., Birmingham, Ala.
First National Bank, Lead, S. D.
Franklin Society, 38 Park Row, New York City.
Frieden, Ben W., 334 Davidson Building, Sioux City, Iowa.

G

German-American Bank, Springfield, Mo.
Gooden, B. P., Mercantile Bank of the Americas, New York City.
Groves, J. W., advertising manager, Northwestern National Bank, Minneapolis, Minn.

H

Hamsher, C. F., First National Bank, Los Gatos, Cal.
Hann, Victor F., manager publicity department, The Fifth Avenue Bank, New York City.
Hardee, D. L., publicity manager, Wachovia Bank and Trust Co., Winston-Salem, N. C.
Harper, W. A., Lumberman's National Bank, Houston, Tex.
Hatton, E. A., cashier, First National Bank, Del Rio, Tex.
Hill, John R., Barnett National Bank, Jacksonville, Fla.
Hoagland, Jessamine G., publicity manager, National City Bank, Chicago, Ill.
Hokanson, N. M., State Bank of Chicago, Chicago, Ill.

J

Jarvis, Charles D., c/o Savings Bank of Utica, Utica, N. Y.
Jenkins, W. L., Farmers and Mechanics Trust Co., West Chester, Pa.
Jessup, Theodore, Woodlawn Trust and Savings Bank, 1204 E. 63rd Street, Chicago, Ill.
Jones, W. P., assistant cashier, First National Bank of Commerce, Hattiesburg, Miss.

K

Kahn, A. T., vice-president, Commercial National Bank, Shreveport, La.
Kankakee County Trust and Savings Bank, Kankakee, Ill.
Kay, W. R., Jr., advertising manager, Sacramento Bank, Sacramento, Cal.
Keller, C. B., Jr., assistant cashier, Stroudsburg National Bank, Stroudsburg, Pa.
Keyton, Grover, New Farley National Bank, Montgomery, Ala.

L

Lindhjem, A. E., assistant cashier, Scandinavian-American National Bank, Minneapolis, Minn.
Logan, John, cashier, Columbus State Bank, Columbus, Mont.

M

McDowell, J. H., c/o American Trust and Banking Co., Chattanooga, Tenn.
 Mann, Ralph H., Park Trust Co., Worcester, Mass.
 Marvel, Charles S., The First-Second Savings and Trust Co., Akron, O.
 Matthews, Dave S., assistant cashier, Farmers and Merchants Bank, Stockton, Cal.
 Matthews, H. B., S. W. Straus & Co., Straus Building, Chicago, Ill.
 Merrill, Frank, advertising manager, The Northwestern National Bank, Minneapolis, Minn.
 Meyer, A. J., Union Trust Co., Rochester, N. Y.
 Milla, W. C., Publicity department, Metropolitan Trust Co., 60 Wall Street, New York City.
 Multhead, G. C., vice-president, The Stock Growers State Bank, Worland, Wyo.

N

Northwestern Trust Co., R. P. Sherer, vice-president, St. Paul, Minn.
 Norton, W. W., treasurer, Robbins Burrall Trust Co., Lakeville, Conn.

O

Old State National Bank, Evansville, Ind.
 Overton, J. A., cashier, The National Bank of Smithtown Branch, Smithtown Branch, N. Y.

P

Parish, R. B., cashier, Bluefield Bank, Bluefield, W. Va.
 Poole, John, president, Federal National Bank, Washington, D. C.
 Potter, A. E., president, Broadway National Bank, Nashville, Tenn.
 Potts, W. W., treasurer, The Federal Title and Trust Co., Beaver Falls, Pa.
 Publicity Department, St. Louis Union Bank, St. Louis, Mo.

R

Ruff, William J., cashier, Luzerne County National Bank, Wilkes-Barre, Pa.
 Russell, W. W., cashier, First National Bank, White River Junction, Vt.

S

Schlenker, Almot, assistant cashier, First National Bank, Brenham, Tex.

Schulze, Paul T., assistant cashier, State Bank of La Crosse, La Crosse, Wis.
 Scott, Walker, vice-president, Virginia Trust Co., Richmond, Va.
 Shepherd, George W., c/o International Trust Co., Boston, Mass.
 Smith, A. C., vice-president, City National Bank, Clinton, Iowa.
 Smith, T. K., Jr., manager, Gimbel Brothers, bankers, New York City.
 Stephenson, J. E., Atlantic National Bank of Jacksonville, Jacksonville, Fla.
 Stewart, F. E., Chesborough Dwellings, Jefferson Avenue, Toledo, O.
 Stoner, T. H., cashier, The Peoples National Bank, Waynesboro, Pa.
 Stover, J. C., secretary-treasurer, Indiana Savings and Loan Association, South Bend, Ind.

T

Taylor, C. E., Jr., president, Wilmington Savings and Trust Co., Wilmington, N. C.

U

Union Trust Co. of D. C., Washington, D. C.

V

Van Blarcom, Wessels, assistant cashier, Second National Bank, Paterson, N. J.
 Van Name, Miss M. I., 515 Stephen Girard Building, Philadelphia, Pa.

W

Wadden, John W., Lake County Bank, Madison, S. D.
 Williams, F. H., assistant treasurer, Albany City Savings Institution, Albany, N. Y.
 Williams, J. E., assistant cashier, Third National Bank, Scranton, Pa.
 Wilson, C. C., c/o Continental and Commercial Trust and Savings Bank, Chicago, Ill.
 Withers, K. K., publicity manager, County Savings Bank, Scranton, Pa.

Z

Zimmerman, Frank A., Chambersburg Trust Co., Chambersburg, Pa.
 Zimmerman, Paul E., cashier, Oak Park Trust and Savings Bank, Oak Park, Ill.

NEW NAMES

Lanier, B. W., First National Bank, Lakeland, Fla.



"A Scrap of Paper"

By Hon. W. G. McAdoo, Secretary of the Treasury

A PATRIOTIC citizen of the United States came into my office, and said, "Give me a pad and pencil." I picked up a piece of paper, a "scrap of paper" that was on my desk, and handed it to him. With a lead pencil he wrote: "I hereby subscribe for \$5,000,000 of the Liberty Loan of 1917, and I agree to pay for it whenever called upon by the Secretary of the Treasury to do so," and signed his name. That was a thrilling incident to

me, because there was the answer of the American people to Germany's declaration that a sacred obligation is no more than a "scrap of paper." We answer it with another "scrap of paper." Upon that "scrap of paper" was expressed the spirit and determination of America that the billions of dollars of resources of this nation would be expended, if necessary, to vindicate the principles of liberty, justice, and humanity throughout the world.

National Bank Resources

THE Comptroller of the Currency has made public the figures as to the condition of all national banks as of the date of the last call, May 1, 1917.

Total deposits on May 1, 1917, amounted to 13,075 million dollars, the greatest ever before shown, exceeding by 118 million dollars the deposits of March 5, 1917, and exceeding by 1,944 million dollars the deposits of May 1, 1916.

The total resources were 16,144 million dollars, an increase since March 5, 1917, of 165 million dollars and an increase since May 1, 1916, of 1,948 million dollars.

Loans and discounts amounted to 8,751 million dollars, an increase since March 5, 1917, of 38 million dollars and since May 1, 1916, of 1,145 million dollars.

Specie and legal tenders on hand plus balances in Federal Reserve Banks amounted to 1,525 million dollars, a decrease as compared with March 5, 1917, of 39 million dollars and an increase since May 1, 1916, of 320 million dollars.

United States Government bonds owned 768 million dollars, an increase of 53 million dollars since March 5, 1917, and of 29 million dollars since May 1, 1916, due to purchase of Treasury certificates of indebtedness.

Other bonds and securities were reported at 1,857 million dollars, an increase since March 5, 1917, of 87 million dollars and an increase since May 1, 1916, of 331 million dollars.

Amount due from banks other than Federal Reserve Banks was 1,838 million dollars, a decrease as compared with March 5, 1917, of 178 million dollars and an increase as compared with May 1, 1916, of 117 million dollars.

Bills payable and rediscounts 92 million dollars, an increase since March

5, 1917, of 22 million dollars and since May 1, 1916, of 28 million dollars.

Amount due to banks and bankers was 3,379 million dollars, a reduction since March 5, 1917, of 304 million dollars but an increase since May 1, 1916, of 383 million dollars.

The total reserve held May 1, 1917, was 2,473 million dollars, a reduction as compared with March 5, 1917, of 168 million dollars, but an increase as compared with May 1, 1916, of 313 million dollars. The surplus reserve over and above the amount required, on May 1, 1917, was 974 million dollars, a reduction as compared with March 5, 1917, of 135 million dollars, but an increase as compared with May 1, 1916, of 105 million dollars.

The percentage of reserve to deposits May 1, 1917, was 24.05, as compared with 25.18, March 5, 1917, and 24.60, May 1, 1916.

On May 1, 1917, the Central Reserve cities held 20.47 reserve against a required reserve of 18 per cent. other reserve cities held 22.84 against a required reserve of 15 per cent., while country banks held 27.29, the amount required with them being only 12 per cent. The percentage of reserve held by country banks on March 5, 1917, was 28.36, Central Reserve cities, 21.31, and of other reserve cities, 24.48.

The total amount of reserve required to be held May 1, 1917, was 1,499 million dollars and on the date named the banks of the country held in their own vaults 763 million dollars and with the Federal Reserve Banks 762 million dollars, making a total of 1,525 million dollars, being 26 million dollars more than the total amount of reserve required to be held, including balances with reserve agents.

Therefore it is seen that the total amount of balances carried with Reserve agents, 948 million dollars, to-

gether with 26 million dollars of excess reserve with the Federal Reserve Banks and in vault, all represented surplus or excess reserve. The banks have thus already accommodated themselves to the time when the balances carried in

national banks in central reserve and reserve cities can no longer be counted as reserve, holding as they now do the entire required reserve in their own vaults and in the Federal Reserve Banks.

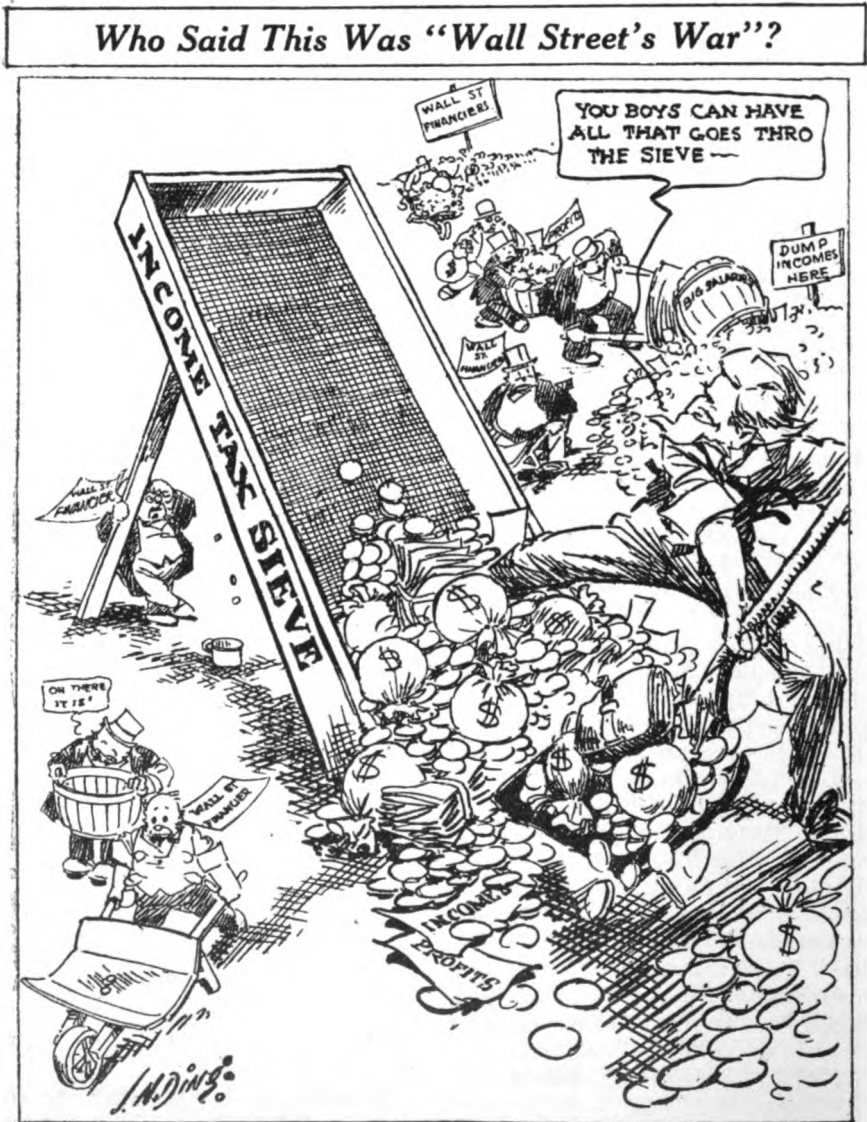

Reproduced through the courtesy of the New York Tribune.

The War Situation in its Relation to Business Enterprises

By EDWIN D. WEARY, President Weary & Alford Company,
Chicago

THERE is much speculation as to the effect of war conditions on building enterprises. Much of it is pure guess work, but it is apparent that the recent advance in most of the materials which enter into building construction are hysterical and wholly unwarranted by actual conditions.

This company having in hand some eighteen bank building operations has carefully analyzed the situation and finds that the present bidding averages from twenty to twenty-one per cent. higher than the prices of January of this year.

Very little of this advance is justified, either by the increased cost of production or by demand, and if the demand does not materialize these prices cannot be maintained.

The construction of a building, unlike things for current consumption, is a permanent investment based on rental revenue, and unless rentals are permanently advanced it is manifestly impractical to increase the investment by twenty per cent., and as a result building operations of this class must be materially restricted.

This means that architects, contractors, manufacturers and material men, except those who get fat Government contracts, will be idle, which must and will induce low prices, and this is a plain proposition of economic law.

It is said that during the coming year ten billion dollars will be scattered abroad in this country by this Government and by foreign countries for the purchase of materials and supplies, and what is to become of the money?

If all kinds of business, except that of munitions and food, are not to succeed,

how are the people to prosper and pay war taxes? What will happen to the manufacturers of marble, glass, terracotta, tile, cabinet work, cement and a hundred other commodities which are not required for war purposes? Surely, this bountiful supply of money should create real and well balanced prosperity.

The remedy, it seems to me, is for the Government to exercise the same supervision over materials and merchandise that undoubtedly must prevail over food and munitions. It should say to the people, "There shall be no extortions. We shall not permit you to charge the Government one price and the people two prices. We want our people to pursue their avocations and prosper."

Our belief is that even without this action of the Government the time is near at hand when by reason of restricted building operations and lack of employment, there will be an awful slump in prices and building can proceed. As an evidence of this, one contractor stated to us a few days since that he could better afford to handle a building at three per cent. than to disband his organization.

Consequently, we are advising bankers who know they must build to proceed with their drawings and specifications and thus be ready to take advantage of this slump before the rush which must surely come, as it will in turn bring about a natural advance because of demand.

This seems entirely logical, and it is always good business to put plenty of time and study into drawings and specifications to insure the best and most

economical result. This war bond money is going to stay in this country, and it should circulate and have a full

purchasing power rather than a purchasing power of eighty cents on the dollar.

Statute of Hamilton at Washington

SINGULARLY enough, Alexander Hamilton, the first Secretary of the Treasury, has up to this time remained unhonored by a statue at the National Capital. This seeming lack of adequate appreciation of one of the men who next to Washington and Jefferson is deserving of honor as a founder of the nation is shortly to be remedied, as may be seen from the following announcement authorized by the Treasury Department:

A patriotic American woman of New York has offered to present to the people of the United States a statue of Alexander Hamilton, to be erected in the city of Washington. This will be the first memorial in the National Capital to the first Secretary of the Treasury.

The donor is an intense admirer of Hamilton and the greatness, genius, and statesmanship with which he served the Republic during its formative days. Secretary McAdoo was very anxious to make public the name of the donor, in order that the people of the country might know of her generous and patriotic spirit, but as the gift was made in honor of Hamilton, she desired that fact to stand alone and not to mingle with it any credit to herself. The Secretary regrets that he is unable to reveal the name of the noble woman who has made this splendid gift to the nation.

The sculptor selected is J. E. Fraser, who designed the 5-cent coin now in circulation. Mr. Fraser was chosen by the donor and is about to begin work on the memorial.

The statue will be erected on the south plaza of the Treasury Department. The site was selected by Secretary McAdoo and approved by the Fine Arts Commission. The Treasury plaza was selected as the most appropriate location for the statue because among Hamilton's many services to the nation those rendered in respect to the fiscal system were both conspicuous and enduring. For that reason the Treasury site is regarded as singularly fitting.

For years an attempt has been made to erect a memorial to Hamilton, but without result. By joint resolution approved March 4, 1909, Congress appropriated \$10,000 for the preparation of a site and the erection of a pedestal upon which to place a memorial to be erected by the Alexander Hamilton National Memorial Association. This organization for several years has been endeavoring to collect funds with which to erect the statue and has collected \$6,000 or \$7,000 for that purpose. It is the intention to utilize the congressional appropriation and the collections of the Alexander Hamilton Memorial Association to prepare the site and erect the pedestal upon which the statue donated will be placed. The donor of the statue did not know of the plans of the Alexander Hamilton Memorial Association when she proposed the gift, and, desiring to present the complete statue, accepted the suggestion that the congressional appropriations and the funds of the association be used for the preparation of the site and pedestal. She will give the statue in its entirety.

Book Reviews

AMERICAN WORLD POLICIES. By Walter E. Weyl. New York. The Macmillan Co. Price, \$2.25.

SINCE the concluding chapter of this book was written, the United States has become involved in the great world war, and therefore our present problem has been changed quite materially from what it was. Our immediate concern is not with a programme for reshaping the policies of the world with a view to the preservation of peace, but to bring about the defeat of those against whom we are now fighting. In other words, America just now is not concerned about peace, but war.

Nevertheless there must come a time when reconstruction will take the place of destruction, and then the student and the statesman may turn to "American World Policies" as a safe guide, for assuredly future economic development will be along the lines which Mr. Weyl suggests.

The economic causes of war are carefully analyzed and practical suggestions made looking to the reduction of these causes.

"American World Policies" will stimulate thinking of a kind which the times sadly need.



BUSINESS FINANCE. By William H. Lough. Ronald Press Co., N. Y. Price, \$3.00.

This book in one volume tells what the average business man ought to know about financing, about raising capital for new enterprises and managing the current expenses of going concerns.

Eminently useful not only for financial managers, but for investors in any kind of financial enterprise. Presents in an organized systematic way information of intense interest and of vital importance to business.

SOME LEGAL PHASES OF CORPORATE FINANCING, ORGANIZATION, REORGANIZATION AND REGULATION. By Francis Lynde Stetson and Others. New York. Macmillan Co. Price, \$2.75.

Discusses the Sherman Anti-Trust Law and the Clayton Act and important phases of the law of inter-corporate relations that are necessarily involved in any present-day consideration of the financing and reorganization of corporations.



TALKS ON BUSINESS CORRESPONDENCE. By William Cushing Bamburgh. Little, Brown & Co., Boston. Price, \$1.00 net.

"Letter-writing is neither a new nor a lost art. It is, however, an art which has been abused and needs correction and readjustment."

In this book, written by the advertising manager of the New England Telephone and Telegraph Co., there is a fairly complete discussion of the principles, customs, rules and methods, practiced by experienced business men and corporation officials throughout the country.



INTEREST TABLES FOR SMALL LOANS. Compiled by Arthur H. Ham. New York: The Spectator Co. Price, \$1.

This book contains interest tables for small loans and formulae for calculating interest and discount, having been prepared especially for the use of small loan companies and associations and credit unions.

It should be of interest and value to persons generally interested in questions pertaining to small loans and of

special assistance to officials charged with the administration and enforcement of laws regulating the small loan business.



HOW TO MAKE GOOD. By Alfred T. Hemingway. Chicago: The Reilly & Britton Co. Price, \$.75.

The power of determining to get ahead, the value of self-inventory and of sportsman qualities of the right sort, are emphasized with many other qualities indispensable to success.

THE TAYLOR SYSTEM OF SCIENTIFIC MANAGEMENT. By C. Bertrand Thompson. A. W. Shaw Co. Price, \$10.00.

This manual is intended to tell just what the Taylor system is; not alone the theory, the history, or the arguments

around and about it, but enough of its mechanism, its methods of development and operation in actual practice, to enable the inquiring manager to visualize in some detail the system itself.

The system as described in this manual consists of those details which are common to a large number of plants systematized by members of the Taylor group.



BUSINESS LAW FOR BUSINESS MEN. By Utley E. Crane. The John C. Winston Co., Philadelphia. Price, \$3.50.

Recognizing that the average business man has neither the opportunity nor inclination to pursue a systematic study of business law, this work has been specially prepared to meet the requirements of the busy man of affairs.

Omission of any citation of authority and all legal technicalities has been for the purpose of rendering the work interesting as well as instructive.



The Banker's Part

By FRANK C. MORTIMER

Pacific Coast Representative National City Bank of New York

WE must, with all the strength of which we are capable, impress upon the people the responsibility that rests upon each of us as a citizen to bear his part in carrying out the purposes of the nation. For we, as individuals, have profited beyond ordinary measure from the peace and prosperity that have for so many years been assured to us by a beneficent government. Through the strength that comes from union; through the power that is generated from the energies of many with a common aim; through the strengthening ideals that have been fostered by our government, we citizens as individuals have, beyond the ordinary lot, received the benefits of organized soci-

ety; and as we have prospered so we must meet responsibility. The nation has given us freely and abundantly, and now we must in turn repay her. Surely, we bankers of the United States should impress this gospel upon our people, that in this present war that we are waging for democracy it is the duty of each citizen to take his part, gladly to render his tribute, and, while many give their lives, freely to accord at least abundant measure of financial support and prove his patriotism through investment in our nation's bonds. In this stupendous struggle the supreme test will be met partly through war bonds, and war bonds, to be successful, need the people's purse.

International Banking and Finance

Emancipated Russia

By RODNEY DEAN

II.—FINANCIAL RUSSIA

BEFORE the war the largest single item of revenue in the Russian budget was derived from the liquor monopoly, which yielded in gross nearly a billion roubles, or half a billion dollars, yearly. Consequently when the Tsar, presumably at the instance of the Grand Duke Nicholas, enforced absolute prohibition of the sale of vodka at the very beginning of the war, he struck what many considered a crushing blow at Russian Government finance. After three years of war, however, this step has been completely justified. In the 1917 budget the lost revenue has been more than made up by new or increased taxation, which the economically regenerated people have been well able to bear. Moreover, the money which would have been spent in vodka has largely been deposited in the State savings banks and utilized by these institutions for investment in the internal war loans, so that it has been by no means lost to the State.

Next to the Government spirit monopoly the most important source of revenue was the State Railways, which yielded in 1913, the last normal year, a gross revenue of 733,000,000 roubles, or about \$366,000,000. It is estimated that during 1917 this item will amount to over a billion roubles. This is chiefly a bookkeeping increase, however, as these revenues have been largely derived from transport of troops, and are simply paid by one department of the Government to another. In addition, operating expenses have of course enormously increased.

Revenue from a third source, that of taxation, was classified as follows: direct taxation, which yielded 7.9 per

cent. of the total revenue; indirect taxation (20.7 per cent.), and "duties" (6.8 per cent.). Customs duties, however, were classified under "indirect taxation".

The proceeds of taxation in 1917 will constitute over one-half of all revenue.



City Hall, Petrograd. Home of the City Duma of Petrograd

Beginning with January 1, 1917, there has been introduced a general progressive income tax which will yield nearly one-fourth of the total revenue from direct taxation. This tax is regarded by the Russian Government as a sound basis for tax reform. Along the lines of indirect war taxation, excise duties have been increased on tobacco, petroleum products, wines, and several other articles, and an excise duty introduced on

tea, in addition to the existing customs duty. The authorities have been for some time considering the imposition of an excise duty on electric power, textiles, and gunpowder.

According to the custom of Russian Government finance, the great bulk of war expense is not provided for in the official yearly budget, but is covered by



Kazan Cathedral, Petrograd

the proceeds of "credit operations," or loans. The war is now estimated to be costing Russia 50,000,000 roubles, or \$25,000,000, per day, and the Government debt, which amounted before the war to about \$1,500,000,000, had increased on January 1, 1917, to over \$12,500,000,000. To pay this huge cost Russia has borrowed both at home and abroad. On the internal market, in addition to the sale of a large amount of short-term Treasury bills, she has floated several five and five and one-half per cent war loans of a permanent character, totaling about 6,000,000,000 roubles, or \$3,000,000,000, and is now placing another "Loan of Freedom" of 3,000,000,000 roubles. Besides discounting various issues on other foreign markets, she has also placed a \$50,000,000 credit and a \$25,000,000 bond issue in this country within the last year.

SERVICES OF THE BANKS

As hinted above, the banking system of Russia has played a major part in the financing of the war. At the head of this system is the State Bank, the central banking institution, which is under the direct control of the Minister of Finance. Measured by deposits, this

is the largest bank in the world. It has sole right of issue for the entire country, but perhaps its most important function in normal times is that of rediscount for the private commercial banks. Of these latter there are about fifty, of which some fifteen have their head offices in Petrograd. Among these fifteen are included nearly all the largest banks, and the National City Bank of New York, the only American bank in Russia, and the first foreign bank to receive a Russian charter since 1873. These Petrograd banks, as well as those with head offices in Moscow and the provinces, have a large number of branches, sometimes over one hundred, scattered throughout Russia and, in fact, the world. The fact that in Siberia and Central Asia interest rates are naturally extremely high has made banking in Russia very profitable. The Russian commercial joint-stock banks are, after the fashion of the German banks, heavily interested in the industries of the country. Each bank has its own "pet" industrials and railroads, of which it holds large blocks of stock, keeping its own representatives on the board of directors.

Other banking institutions operated by the Government are: the Nobles' Land Bank and the Peasants' Land Bank, their names indicating the class



Sadovaya Street, Petrograd

of business they do; and the Government Savings Banks, mentioned above, of which there are over 10,000. The deposits of these savings banks have increased during the war from 1,700,000,000 roubles to 4,000,000,000 rou-



With close and important connections in the Orient, the Irving offers unexcelled facilities for the development of Far Eastern business.

IRVING NATIONAL BANK

WOOLWORTH BUILDING

Strictly A Commercial Bank



NEW YORK

Resources over \$100,000,000

bles. While this enormous increase is largely due to the abolition of vodka, there are other factors which must be considered. The peasants have stopped making payments on their land to the Peasants' Land Bank, and the families of soldiers who have gone to the war have been to some extent cared for by the Government. Large amounts of money from both these sources have been accumulating in the savings banks.

Municipal banks, and mutual credit societies, complete the structure of the Russian banking system.

THE CURRENCY SYSTEM

In considering Russia's financial position a knowledge of the history of her currency is valuable. Beginning with 1843 there were issued Imperial credit notes "payable in silver or gold." In practice, however, these notes were not convertible at any fixed rate, but would only be exchanged at the current market rate. The rouble was worth about seventy-five cents at par, but became greatly depreciated, finally becoming

somewhat stabilized at fifty-one cents. So in 1896-7, when the gold standard was definitely established by Count Witte, this ratio was fixed by law, three roubles of the new standard for two of



The Nevsky Prospect. The main business thoroughfare of Petrograd

the old, or fifteen roubles to a gold "Imperial" instead of ten, as formerly.

Before the war, the State Bank was authorized to issue only 300,000,000 roubles of unsecured notes; all issues above that figure had to be covered with

Remittances to U. S. Forces Abroad

Through the medium of our offices in London, Liverpool, Manchester and our agents in Paris, we will be pleased to undertake remittances to the American forces in Europe, both Naval and Military.

NEW YORK AGENCY

**BANK OF BRITISH
WEST AFRICA, LTD.**

6 WALL STREET

R. R. APPLEBY, AGENT

HEAD OFFICE . . . LONDON

gold, rouble for rouble, and as a matter of fact the amount of notes in circulation was actually less than the gold reserve. During the progress of the war, however, increase after increase has been authorized, until now the paper money in circulation amounts to 13,000,000,000 roubles, while the gold in the vaults of the State Bank amounts to only 1,500,000,000 roubles. This increase in circulating notes has naturally been accompanied by a corresponding increase in the item of "Short Term Obligations of the Treasury" in the Assets side of the State Bank's balance-sheet. This item did not appear at all in the statement of July 29, 1914, just before the war, but had risen by March 29, 1917, to over 8,000,000,000 roubles. This represents Treasury bills which could not be absorbed by the open market and had to be discounted at the

State Bank. For these Treasury bills the Bank pays out its own notes, which then pass into circulation.

Russia is now entirely on a paper basis. When I first arrived in Petrograd in September, 1915, part of the circulating medium was made up of



Georgian Military Road across Caucasian Mountains

small nickel coins of ten, fifteen and twenty kopecks. Soon afterward, however, paper money of the size of postage stamps, for which the regular postage-stamp dies were used, was issued in these denominations. The nickel coins immediately disappeared from circulation, leaving only paper and coppers, and the copper coins also were later almost entirely displaced by small paper notes.

Prices are high in Russia partially because of shortage of supplies growing out of inadequate and inefficient transportation methods. It has been one of the first problems of the new Government to correct this latter fault, and a special American railway commission is already in Russia to assist them. The rise in the cost of living, however, is largely due to inflation and consequent depreciation of the rouble. Abroad, moreover, the rouble is at a heavy discount because of the almost complete cessation of Russian export trade, together with greatly augmented imports, resulting in a markedly unfavorable balance of trade. With all this, there will naturally be a great temptation toward another devaluation of the rouble after the war. This step would result in an enormous saving to the Government. However, the Finance Ministry has al-

ways been opposed to such a step, considering that the damage to Russian credit would more than offset any temporary gain. It is entirely possible, moreover, that by the coördinated de-

velopment of her vast resources Russia will be able to restore her exchanges without any such radical measure. A detailed discussion of this point will be taken up in my next article.



Economic Chosen

FROM information furnished THE BANKERS MAGAZINE by the Bank of Chosen, the following facts are presented regarding that part of the Far East.

The peninsula of Chosen is separated from Japan by a strait 122 miles in width which may be crossed in less than ten hours. Its climate in winter is described as "superb" and in summer "supportable."

Chosen derives great advantage from being located on the great highway between the East and West. The trunk line of the Chosen Railway, which runs through the country lengthwise, is connected at one end with the Japanese Government railways via the ferry service across the strait, and, at the

other, in conjunction with the South Manchurian railways, with that great transcontinental railway which links Europe to the Far East, and also with the railway systems in China leading to Peking, Shanghai, Hankow, etc. Thus the erstwhile Hermit Kingdom, secluded from the rest of the world, has been converted into the most communicative of all nations in the East.

The area of the country is 84,000 square miles, or nearly as large as the mainland of Japan, and two-thirds the size of the British Isles. Its population is 15,929,962, of which 291,217 are Japanese. The population, both Japanese and Korean, is increasing.

While the country is mainly devoted to agriculture, commercial and indus-



The Bank of Chosen, Seoul

trial interests are growing and the cities are gaining in population. Seoul has a population of 287,186; Pingyang 45,511; Fusan, 55,094; Kaisang, 41,730.

The total revenues have increased from yen 19,985,459 in 1910 to yen 58,522,419 in 1915. For some years the deficit of revenues has been made good by a subsidy from the Japanese Treasury, but this subsidy is decreasing and it is now expected that the fiscal independence of the country will be effected in a few years.

As already stated, agriculture is the chief occupation, eighty-three per cent. of the population being thus engaged. Its products amount to about 300,000,000 yen annually and constitute fifty-five per cent. of the country's exports. The soil is rich, and with proper cultivation would yield as much as that of Japan, but much of the farming is still of a primitive character. Rice, soya beans, red beans, barley, wheat, oats, rye and millet are among the leading products, and the production of these crops has been largely increased since 1910. Cotton, ginseng and tobacco are also grown. Sericulture is one of the most promising of Korean industries, conditions of the country being even more favorable than in Japan proper. Silkworm cocoons already constitute one of the principal items of export. From 1910 to 1914 the number of cattle reported increased from 703,844 to 1,338,401.

In mineral wealth Chosen is very rich, the chief products being gold, iron, coal and graphite.

Prior to the Japanese occupation manufacturing had declined, but the Government has taken great pains in recent years to train the people in many branches of the technical arts. Conditions are favorable to the development of manufacturing, such as abundance of raw materials, proximity to markets, cheap labor, and the natural aptitude of the people for technical work. Fishing is also an important industry, the value of the catch rising from yen 7,871,910 in 1910 to yen 12,051,485 in 1914.

Commercially the country is growing at a rapid rate, the total foreign trade advancing from yen 47,555,712 in 1905 to yen 107,360,621 in 1914.

All the railways in Chosen are state-owned, and are controlled by the Railway Bureau of the Government-General of Chosen. The total length of Chosen railways now open to traffic is 1,006 miles, of which 366 miles have been constructed since the annexation. Receipts from railway and passenger traffic increased from yen 5,142,446 in 1910 to yen 7,734,260 in 1914.

BANKING

One of the chief difficulties which long retarded the economic progress of Chosen was the lack of a proper currency and of a good banking system.

COX & CO. (France) Ltd.

place their branches in France at the disposal of the Military and Naval forces of the United States, in Europe, for the remittance of funds and general banking business.

This bank was formed as a subsidiary of Cox & Co., founded in 1758, 16 Charing Cross, London, the official British Army Agents, for the convenience of the British Army in France.

Branches have been established with a British Staff at all the chief military bases.

Paris, Rouen, Havre, Boulogne, Amiens, Marseilles,

and agencies at

COX & CO., 16 Charing Cross, London,

and

LONDON & SOUTH-WESTERN BANK, LTD.,

170 Fenchurch Street, London.

who are the joint proprietors.

During the protectorate régime, the reform in the coinage system of the realm was nearly completed, and the banking system was put in fairly good working order. But it was only after the annexation that all these monetary organs were sufficiently developed so as to contribute greatly to the welfare of the people.

At the end of the year 1910, in which the annexation took place, there were in Chosen eleven head banking offices and fifty-nine branch offices. At the end of 1916 the number had increased to eighteen head offices and seventy-eight branch offices. During the same period, the number of credit associations, the chief purpose of which is to supply agricultural funds to peasant farmers, increased from 177 to 233. Also, during the same period, the sum total of the assets of all the banks in the country increased from yen 62,611,000 to yen 98,764,000, deposits from yen 18,868,000 to yen 33,863,000, and advances from yen 42,681,000 to yen 66,461,000.

The banks operating in the peninsula may roughly be divided into three classes, namely, the Bank of Chosen (which is the central bank), ordinary commercial banks and agricultural and industrial banks. There are besides local credit associations and the banking department of the Oriental Development Company.

The Bank of Chosen, formerly called the Bank of Korea, was established in October, 1909, as the central bank of Chosen. The following year the country was annexed by Japan, and, in con-



Advice to Investors

Purchase your securities through responsible dealers who have proper facilities for investigations and a reputation to maintain for reliable advice.

K. N. & K. are always posted on general market conditions, and their views are at the disposal of investors through their monthly review of

"The Investment Situation"

Write for pamphlet L-1

Knauth-Nachod & Kuhne

Members of New York Stock Exchange,

Equitable Building,

NEW YORK CITY.

sequence, the bank was reorganized under Law No. 48 and renamed the Bank of Chosen. The capital* is yen 10,000,000, of which 3,000,000 is sub-

*The capital, hitherto yen 10,000,000, has been increased to yen 20,000,000 by the resolution passed at the general meeting of shareholders held on the 20th of February, 1917, and the first call on the new shares having been paid up on April 21, the present paid-up capital of the bank stands at yen 12,500,000.



Two views of a street in Heljo before and after modern improvements were provided

scribed by the Government. The bank does all kinds of banking business, including that of an ordinary commercial bank as well as that of a central bank, such as: handling of Treasury money, issuing of bank notes, loans, discounting, deposits, exchange, purchasing of gold, etc. It has branches in Chosen, in Japan and in Manchuria. Under its charter the bank was to receive, if necessary, a subsidy from the Government for five years dating from its establishment, but the progress of its business was such that only two years after its establishment it became independent of such aid.

Progress of the bank is indicated by growth in deposits from yen 5,960,650 on December 31, 1910, to yen 33,033,409 at the end of December, 1916. Since the establishment of the bank in 1909 the results of its operations have always been satisfactory, the net profit of each half-year being greater than the preceding one.

ORDINARY COMMERCIAL BANKS

At the time of the annexation, there were in Chosen altogether eight of these banks, three established by Koreans, one by Japanese, and four being Japanese banks, with twenty-four offices in all. Since the annexation, seven banks have been established, with the result that there are now in Chosen eleven banks having head offices in Chosen with

twenty-four offices and four Japanese banks with fifteen offices.

Their progress during the past five years was generally satisfactory, their total assets increasing from yen 18,243,980 in 1910 to yen 26,553,900 in 1914.

AGRICULTURAL AND INDUSTRIAL BANKS

The agricultural and industrial banks in Chosen were established by virtue of an imperial edict issued by the ex-Korean Government in 1906. Government aid was given to them in the form of subscription to their shares, grant of loans, guarantee given for their debentures, etc. The banks developed and generally prospered. But the progress of the times made it necessary to define their sphere of operations on a new basis and this gave birth to a new agricultural and industrial act, promulgated in 1914.

At the end of 1910, the year of the annexation, there were six of these banks with twenty-seven branches which, by the end of 1914, had increased to thirty-seven. Their total assets advanced from yen 8,183,614 in 1910 to yen 14,410,898 in 1914.

CREDIT ASSOCIATIONS

These were established by virtue of an imperial edict issued by the ex-Korean Government in 1907. By the end of 1910 there were 177 associations in existence which have since been increased to 233. The members of the associations have now reached 65,339, and the sum total of the advances made amounts to no less than yen 2,125,000. They are very small institutions but are rendering important services to the peasants by supplying them with necessary funds for agricultural purposes, providing warehouse accommodation for members, distributing or lending seeds, manures, etc., and by undertaking consignment sales of members' products.

CLEARING-HOUSES

There are now three clearing-houses in Chosen—in Seoul, Chemulpo and Fu-

NOYES & COMPANY

Established 1879

Foreign Bills

Government and Municipal Bonds

8, Place Edouard VII.

PARIS - FRANCE



Chestnut Street west of Broad

ORGANIZED in 1900,
The Franklin National
Bank of Philadelphia
has capital of one million
dollars, surplus and profits
of over three and three
quarter million dollars,
and total resources of over
sixty million dollars—
a record of growth, sub-
stantial and unequalled.



UNION *National Bank* OF CLEVELAND

In our new building with modern equipment we are better prepared to render good service to our friends.

*“Expedition Service now—
Long Experience taught Us How”*

WARREN S. HAYDEN, Chairman of the Board

GEORGE A. COULTON, President

WILLIAM E. WARD, Vice-President

FRED. W. COOK, Asst. Cashier

ELMER E. CRESWELL, Vice-President

CARL F. MEAD, Asst. Cashier

WALTER C. SAUNDERS, Cashier

HARRY E. HILLS, Asst. Cashier

FRANK A. WHITE, Asst. Cashier

PAR COLLECTIONS

It costs either time, exchange, or service to handle country checks but we collect everything at Par for our customers who maintain adequated balances. We analyze items at the cheapest possible rate irrespective of whether we collect them direct or through the Federal Reserve Bank.

THE FIRST NATIONAL BANK

PHILADELPHIA, PA.

**Eligible to Secure
Government Deposits**

State of Tennessee

**4½% Bonds due 1924-31
4½% Bonds due 1920-29**

Exempt from Federal Income Taxes

**Legal Investment for Savings Banks in New York,
Connecticut, Etc.**

Eligible to secure Government Deposits in connection with Liberty Loan and Postal Savings Deposits, at 100% of market value not over par.

Prices Upon Application

Send for Circular 146-B

Redmond & Co.

33 Pine Street,

New York

san. Bills cleared rose from a total of yen 20,489,580 in 1910 to yen 90,833,158 in 1914.

ASSIMILATION OF KOREANS

It is stated that the assimilation of Koreans and Japanese is going on rapidly and smoothly. Geographical proximity, a common origin, good govern-

ment, with accompanying peace and prosperity, are contributing to this result.

Education is progressing most favorably, the number of public schools for Koreans increasing from 126 in 1910 to 420 in 1914; the number of teachers from 752 to 2,081, and the number of students from 17,095 to 64,958.



Opportunities in Italy for American Capital*

By LUIGI CRISCUOLO

With the Firm of Redmond & Co., Investment Bankers, New York

PRIOR to the outbreak of the European War, several large banking institutions located in the United States had been paying particular attention to South American countries as a profitable field for American capital. The National City

Bank of New York established branches in some of the large cities and several smaller banks have been organized with the avowed purpose of securing for

*This article is published simultaneously in "The Italian Review"—*Il Carroccio*—of July.

Americans a portion of the commerce that has been for many years in the hands of the British and Germans.

Since the war began, particular attention has been focussed on opportunities in Russia perhaps because Russia as a country is similar, in physical condition, to the United States of fifty years ago, and therefore susceptible of a great deal of development in the field of industry, agriculture, mining and transportation. American banks have also made an attempt to gain a foothold in other countries in Europe, but it is certain that they will have to meet the strong competition of British and French banks which, in spite of the war, are already strongly entrenched in all of the allied countries, and are now looking far ahead.

Foreign trade and foreign concessions are vital to countries which have surplus products and surplus capital. But the expansion of business should be attained in a fair and friendly manner not calculated to excite the jealousies, natural to human beings, of other nations with similar desires. We must not forget that, along with race prejudices and tyrannies of large states against small ones, *trade jealousy* was a very important factor in the conditions which led up to the present horrible struggle, and enterprising Ameri-

must be remembered that the greatest profits in the exploitation of capital are made in the development of virgin lands where little or no modern methods of mining, manufacturing or agriculture have been used. Such opportunities exist in a grand scale in the countries mentioned, but not to such a vast extent in Italy. Any capital that can find its way from the United States into Italy must needs be used to improve the many already highly developed enterprises existing there. And such financing does not admit of the great profits that are so attractive to promoters on a large scale.

Italy is not the backward nation that some of our American people suppose it to be. Many of our citizens have regarded the humble Italian laborer as the type of the Italian population. Without desiring to minimize the importance of the Italian laborer to American industry, and his necessity as an economic factor, it is hardly fair to judge the progress of Italy by the day-laborer as a type. The Italy of to-day has really lived for less than half a century and in the past twenty years has made its greatest progress. That it is not behind in industrial development is proven by some pertinent figures taken from a circular of the "Credito Italiano," which are tabulated herewith:

<i>In Lire—</i>	1860	1913
National income from agriculture.....	1,760,000,000	3,000,000,000
National income from cattle industry....	700,000,000	2,000,000,000
Government revenue	552,500,000	2,800,000,000
Capital of corporations.....	1,351,000,000	4,590,000,000
Foreign commerce	1,406,000,000	6,243,000,000
Tonnage of ships	10,228	870,000
Railroads—in kilometers	2,198	17,644
Telegraph lines—in kilometers	8,000	52,000
Manufacturing plants—value	(unknown)	2,500,000,000—1916
Total national wealth.....	35,000,000,000	80,000,000,000—1914

cans will undoubtedly be very careful as to the manner in which concessions of any sort are to be secured.

Whether American capital can be attracted to Italy will depend largely upon what sort of inducements Italy has to offer, and whether these inducements are more attractive than those which Russia, Argentine, Brazil, Bolivia, China and other countries can offer. It

There are 177 commercial banks in Italy with about 1,000,000,000 lire in resources, 692 cooperative credit associations with about 200,000,000 lire divided among capital and reserves, while savings banks have a capital of 3,254,000,000 lire. The total deposits in banks and savings institutions are reported to be 6,827,000,000 lire.

One of the objects which Italy hopes



Scandinavian Trust Company

56 Broadway

New York

Paid-in Capital and Surplus, \$2,500,000

THIS company has been established to meet the large and growing business and financial relations between the United States and the Scandinavian countries, and for the purpose of providing facilities for general foreign and domestic banking.

ALEXANDER V. OSTROM
PRESIDENT

B. E. SMYTHE
VICE-PRESIDENT

T. BARTH
VICE-PRESIDENT

J. C. TRAPHAGEN
SECRETARY

D. CARDOZO
ASSISTANT SECRETARY

Board of Directors

Johs. Andersen
Knut Bachke
Charles E. Bedford
James F. Bell
John E. Berwind
R. R. Brown
William R. Coe
Gerhard M. Dahl
S. E. Dahl
W. Edward Foster
Samuel L. Fuller
Edward F. Geer
Charles S. Haight
G. Kampstrup Hegge
Edwin O. Holter
Frederick W. Hvoslef
N. Bruce MacKelvie
Alexander V. Ostrom
Birger Osland
E. A. Cappelen Smith

J. Andersen & Company
Andresens Bank, Christiania
Vice-President, Vacuum Oil Company
Vice-President, Washburn-Crosby Company
Vice-President, Berwind-White Coal Mining Co.
First Vice-President, American Surety Co.
Chairman, Johnson & Higgins
Vice-President, Chase National Bank
Centralbanken for Norge, Christiania
Treasurer, American Sugar Refining Co.
Kissel, Kinnicutt & Company
Shipowner
Haight, Sanford & Smith
Den Norske Creditbank, Christiania
Attorney
Bennett, Hvoslef & Company
Hayden, Stone & Company
President
Genl. Western Agt., Norwegian-American Line
Guggenheim Brothers

to attain is complete emancipation from control of its finances and industries by Teutonic capitalists. With the victory of the Allies, will disappear all objection on the part of the central powers to the expansion of Italian commercial and banking interests in the Balkans and the Levant. Furthermore, there seems to be no doubt that Italy will be given an important sphere of influence in Asia Minor and Northern Africa to permit of the establishment of colonies for her surplus population, thus contributing to her wealth in the future.

One result of the war will be lack of man-power all over Europe, so that the speeding-up of reconstruction will be a very serious problem. While the men and women who remain at home from the war will have become highly trained to produce unusual amounts of goods, all of this work will have been for *war purposes*, and to all intent and purposes economically non-productive. When the period of reconstruction begins it is expected that there will be little emigration from Europe unless taxation will be so severe as to literally drive people away. Women will be a great factor in industrial fields.

Italy, like the other European countries, will find great need—as she does now—for fuel, raw material, steel, oil, etc., as well as *capital*. It is true that some French and English capital is even now finding its way into Italy, but for the greater supply Italy may have to

look elsewhere. France will have need of capital for reconstruction of its ruined cities, English capital will probably have to be extended to Belgium and other countries, and Italy would not draw upon Germany even if it could.

It is not possible to state whether the United States can take the position of banker to the world after the war is over. However, it would be indeed gratifying to many Italians in this country if the United States could take the place Germany held in Italian finance and industry prior to the war. One writer says that American capital would be particularly welcome in that Italians could not suspect Americans of ulterior motives or political ambitions in Italy to the detriment of the latter.

The fuel question might be partially solved by the construction of more hydro-electric plants, many of which already exist all over Italy. The waters from the Appenines and Alps could be further harnessed and conserved in reservoirs so that even in periods of drought there would be an abundant supply of hydro-electric power. By the popularization of electricity for fuel and light purposes, the demands of Italy for fuel from abroad might be lessened and in the event of a crisis like the present war, all fuel imported could be used for naval purposes solely, while hydro-electric power could be used by manufacturing plants. American engineers have become exceedingly proficient in the construction of hydro-electric plants in recent years and many millions are invested in them.

The Italian people do not lack energy or resourcefulness and this fact has been proved by the wonderful development of their country in the past half century. There being a lack of capital in Italy, it was easy for the German capitalists to gain a foothold. They secured it, with the result that they began to dominate the country not only from an industrial standpoint, but politically as well. Whether it will be possible for American capital to reach Italy is a question of how great the local demand and the demand from other countries will be. American bankers have known

Liberty Trust Company

8, Place Edouard VII.

Total Resources Over

\$10,000,000

PARIS - FRANCE

The Union Bank of Manchester, Limited

Head Office
17 York St., Manchester, Eng.

Liverpool Office
45 Castle St., Liverpool, Eng.

and branches covering the whole of the district tributary to these two cities, and also WEST YORKSHIRE; including SHEFFIELD, BRADFORD, SALFORD, BIRKEN-HEAD, OLDHAM, BOLTON, BURY, ROCHDALE, STOCKPORT, HALIFAX (ENG.), HUDDERSFIELD, etc., etc.

(\$5=£)

Nominal Capital	\$12,500,000
Paid-up Capital -	2,750,000
Reserve Capital	3,500,000
Subscribed Capital	6,250,000
Reserves	1,903,470
Surplus over Liabilities	8,153,470

Bankers in the United States and Canada are invited to make use of the Bank's services for all kinds of banking business in the district where the Bank operates, and in Great Britain generally. Collections promptly dealt with, and proceeds remitted by draft or cable transfer on New York, or as desired. Favourable terms.

little regarding Italian industries. The chances are that any capital invested by Americans in Italy would first consist in government or municipal obligations, and, after connections had been established that inspired confidence, the development of railroads, tractions and other industries might be taken up.

It is true that connections were made with American banking interests when the last Italian internal loan was floated, but this was done through a trust company whose business has not been primarily the sale of bonds to investors or that of catering to Italian clients in a position to develop trade with Italy. The furtherance of interest in Italian industries in America might be accomplished by the organization of an *Italian* trust company in New York. The board of directors could consist of the members of the strongest Italian commercial firms as well as representatives of the investment banking and commercial banking interests. In this

manner active communication could be started at once with a view to financing meritorious enterprises after the end of the war. In the meantime, such an Italian trust company could facilitate and encourage ordinary commerce between Italy and the United States in the same manner that the Canadian, English, Scandinavian and other banks or trust companies have succeeded in doing for their respective countries.

If we have capital to invest at the end of the war, or before, we might better use it to rehabilitate Italy and other friendly European nations, rather than in extending our own facilities, which in some cases have been overdeveloped as far as the requirements of the post-war period are concerned. And it is quite certain that if the United States wishes to assume a predominant position in world commerce, it will pay attention to possibilities in Italy before England or France secure a hold there, just as Germany had it in the past.

The Industrial and Commercial Bank, Ltd. of Hong Kong

THE Industrial and Commercial Bank, Ltd., has been lately organized by progressive and foreign educated Chinese, who have studied economics, finance and banking in America and Europe and also have been in the Chinese Government service. At present the capital is one million dollars, Hong Kong currency. The head office is in Hong Kong. After the expiration of the experimental stage of five years the capital is to be increased to fifty million dollars and the headquarters are to be removed to Shanghai. Branches will then be established in the interior and all the principal cities of China and abroad to do general banking business.

The management of the bank and its branches consists exclusively of foreign educated experts in banking and finance. Such well-known persons as Tien Tau Cheng of Chicago University, Ex-Commissioner of Public Works of Canton; Jun Ke Choy of Columbia University, ex-member of Kwong Tung Legislature; Wai Man Lau of New York University, capitalist, and Cheng Huan of Boston University, ex-member of the Ministry of Agriculture and Commerce, are taking an active part in the undertaking. The subscribers are principally foreign educated government officials and oversea Chinese. The sole ambition of its promoters is to help to devise some ways to solve the economic problem of China, as she is now passing the worst period of her financial history.

Therefore the bank's objects are to furnish organized, economical and efficient means to assist the infant industries that are gradually developing in China, and to bring commercial relations with other countries closer and more directly with the native producers of China. One of the primary reasons why industries are developing so slowly is the lack of good standard Chinese banks, which reason keeps up the high rate of interest charged for the use of capital and so limits its employment by manufacturers. The bank with its branches in getting out the hoarded sur-

plus funds of the country would assist materially in cheapening capital and make it more available for development of industries. Secondly, through the lack of Chinese scientifically managed banks in the interior, the outside world practically could not trade directly with the inland producers except through the treaty ports. Here again the bank comes to the rescue in removing the obstacle by establishing branches in the interior of China and abroad to enable its customers to send a bill of lading or other commercial papers for collection at a much more reduced rate than the present one from the most obscure corners of China, like Chinese Turkestan, to the greatest metropolises of the world, as London and New York. Finally, its issue of bank notes under a strong and a conservative reserve, would be a great step toward facilitating the reform of the perplexed money problems of China, which hinder the development of trade. The bank notes issued would be made uniform in value in different parts of China where it has branches, while at present notes and dollars are at a discount in all provinces but the one in which they originate. In fact at present the actual value of the silver in dollar coins is often a less important factor in the exchange of values between the different dollars themselves than the changeable popular fancy for this or that particular coin.

When the above enumerated objects have been accomplished the bank will not only render a great service to China but also to the whole world in opening up the former industrially and commercially to the latter. China is now passing from the agricultural to the industrial and commercial stage. Capitalism, commercialism and industrialism are just appearing. It is a blessing that her foreign educated sons, with all the experiences that the West has gone through, are acting as pioneers in taking a leading part in her transitional period. No doubt they would avoid the evils of

THE BANK OF CHOSEN

Incorporated by Special Charter of Imperial Japanese Government

(\$0.50 — 1 Yen)
Subscribed Capital, Yen 20,000,000

Paid-Up Capital, Yen 12,500,000

Head Office, Seoul, Korea

Principal Branches :

KOREA: Chemulpo, Pyongyang, Wonsan, Fusan

MANCHURIA: Mukden, Dairen, Changchun, Newchwang, Harbin, Antung

JAPAN: Tokyo, Osaka, Kobe

Affiliated Bank :

EASTERN SIBERIA: Vladivostok-Matsuda Bank

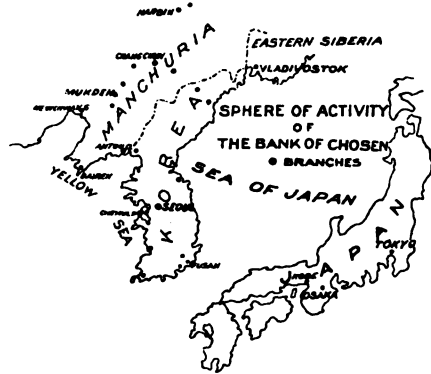

Principal American Correspondents :

Guaranty Trust Company of New York
Irving National Bank, New York
National City Bank of New York
National Bank of Commerce in New York

Yokohama Specie Bank, New York and San Francisco
Canadian Bank of Commerce, San Francisco and Seattle

capitalism, commercialism and industrialism, but bring out the best in them which have made the blessings of modern civilization possible. More institutions of their kind should be founded.

It is hoped that the Industrial and Commercial Bank, Ltd., established with such worthy objects, may serve to introduce capitalism, commercialism and industrialism into China.

Economic Activity in Chosen

THE "Seoul Press" gives some idea of the increase in economic enterprises of all kinds in Chosen during the past few months. It states:

It is a noteworthy fact that in consequence of the prosperous financial condition in the mother country many capitalists there have recently shown an inclination to invest capital in undertakings in Chosen. At least ten manufacturing or mercantile companies have been projected or started here. The establishment of the Chemulpo Dock Co., promoted by business men in Chemulpo, with capital of 150,000 yen (\$74,700), already has obtained official permission. The projected sugar refinery at Pingyang, capitalized at 5,000,000 yen, and the Pingyang branch of the Onoda Portland Cement Manufacturing Co., with capital of 2,000,000 yen, also have obtained official permission for their establishment. A Seoul rice and bean exchange has been separately applied

for by capitalists in Seoul and in the mother country, while similar institutions are projected in Kunsan and Fusan. The Chosen Match Manufacturing Co., capitalized at 500,000 yen, and the Oriental Tobacco Manufacturing Co., capitalized at 1,000,000 yen, have been promoted and official permission applied for. Plans have already been matured by business men of the Mitsui group to establish a spinning mill in Seoul. The establishment in Fusan of a ceramic factory capitalized at 1,000,000 yen is also being projected by a porcelain manufacturer in Kyoto, while a project is maturing among certain mining capitalists to establish a tungsten company in North Choongchongdo. The spinning mill and the ceramic factory will soon file applications with the Government General.

A more detailed description of the spinning-mill enterprise was given in another issue of the paper, as follows:

The project for the establishment of the spinning mill has all but matured and application for permission will very shortly be filed with the Government-General. The mill, it is understood, is promoted by prominent business men in Tokyo, and will be capitalized at 5,000,000 yen. The site already has been selected, but will not be made known for some time.

According to the latest returns, 6,200,000 yen worth of raw sheeting, \$2,000,000 yen of bleached sheeting, 500,000 yen of T-cloth, 130,000 yen of flannel, and 1,160,000 yen of Japanese woolen cloth, in addition to some other cloths aggregating 12,000,000 yen, are imported into Chosen every year. In spite of this, no spinning mill has hitherto been established in the country. On the other hand, the yearly output of cotton in the peninsula stands at 100,000,000 kin (132,277,000 pounds). The cotton has been exported to Japan, where it is manufactured into sheetings and other cloths, which are sent back into Chosen.

Other projected undertakings are: Extensions to the ore refinery constructed by the Kuhara Co. at Chinnampo, where a new and larger furnace was put in operation this month, making a total of four furnaces. (More machinery is to be installed and a new generating house to be built, and additional ground for further enlargements has already been purchased.) Application has been filed with the authorities for permission to construct a hydroelectric plant in North Zenra Province with a capacity of 269 horsepower. It is proposed to supply electricity to the larger towns of the Province, and to engage in the general sale of electrical apparatus. The name of the projected company is the Chosen Hydroelectric Joint-Stock Co. and the plant will be erected at Sannai-men, Seiyu district. The permission of the Government General has been asked for the establishment of a soap-manufacturing company at Fusan with a capitalization of \$25,000. The company is to be known as the Chosen Shoko Kabushiki Kaisha.



Guaranty Trust Company of New York Opens Office in Paris

RECOGNIZING the importance of our new commercial and financial relations with France, and desiring to assist in every possible way those Americans who are serving this country abroad, the Guaranty Trust Company of New York is opening an office in Paris similar to that which it has maintained in London for almost twenty years.

The facilities of this new office enable the trust company to give its customers direct service, to handle to better advantage its large volume of foreign business with France, to participate locally in the work of financing and reconstruction that will follow the close of the war, and to contribute its full share to the development of American

foreign trade in that part of the world.

The Paris office is thoroughly modern in its equipment. It is in a new building at Nos. 1 and 3 Rue des Italiens, within a stone's throw of the Grand Boulevard, and about midway between the Bourse and the Place de l'Opera—the two centres of business activity in Paris.

The Rue des Italiens starts from the Rue Taitbout, turns a right angle and ends at the Boulevard des Italiens, directly in front of the Credit Lyonnais. Such institutions as the Credit Lyonnais, the Banque de l'Union Parisienne, the Banque Nationale de Credit, the Credit Mobilier, and the Banque Union de Moscou, are close neighbors of the trust company's offices, while immedi-

BANKAKTIEBOLAGET SÖDRA SVERIGE

Head Office : HELSINGBORG, Sweden

Branches : STOCKHOLM, GOTHENBURG, MALMÖ, BORÅS and in 47 other
Places in Sweden

Capital Paid Up . . .	(\$.26 = 1 Kr.)	Kr. 30,000,000
Surplus About . . .		Kr. 15,000,000
Resources About . . .		Kr. 260,000,000

The organization and excellent relations of this Bank secure to its clients the most efficient handling of their business on moderate terms

Inquiries and applications for terms are cordially invited and will find prompt attention

Principal New York Correspondents { The Mechanics & Metals National Bank
The National City Bank of New York }

ately to the left of the building are the quarters of "Le Temps," one of the leading Parisian newspapers. In the building itself are the offices of the Consul-General of the United States.

Alexander Phillips has been appointed manager; G. Hebmann, sub-manager; William G. Wendell, secretary, and Richard Staigg, assistant secretary. Mr. Phillips' past experience as representative of the Guaranty Trust Company in Paris, as well as his fifteen years in foreign banking in America and former connections with the Paris office of the Comptoir National d'Escompte, and with the Credit Industriel, both in London and Paris, have given him a thorough knowledge of international banking transactions, as well as of local financial and commercial requirements in France. Mr. Hebmann has been manager of various important branches of the Comptoir National d'Escompte de Paris, such as those in

Lyons and Havre, the French centres for the silk, cotton and coffee trades. Mr. Wendell was the Boston representative of the Guaranty Trust Company before his departure for France. Mr. Staigg, prior to his association with the Guaranty Trust Company in New York, was for many years foreign exchange clerk of the Canal Bank and Trust Company of New Orleans; he has been acting recently as Mr. Phillips' secretary in Paris. Messrs. Bernard Avegno and Robert Bienz, who have been temporarily with the London office, are in charge of the work of various departments in Paris. Olaf Giese is the chief accountant. B. C. Smith, the auditor of the company in New York, is now in Paris with his assistant, Lionel Mundy, installing a system of accounting and auditing similar to that in use in the main office of the Guaranty Trust Company and in all its branch offices.



Italian Commercial Bank

THE report of the board of directors of this institution, presented to the shareholders' meeting of March 28, has recently come to hand. This report states:

"Whilst meeting here for the second time since our country has undertaken the great war for its final redemption, we are sure that we interpret the feelings of all of you in expressing, before

proceeding to our business, our admiration for and gratitude to our heroic Italian soldiers, and in paying reverent and affectionate tribute to the memory of those of our colleagues who have fallen on the field of honor, and to their families who have been so cruelly but so gloriously tried.

"We have determined that these heroic and, unhappily, numerous names

shall be inscribed on marble at the entrance of this office, as a perpetual inspiration and an imperishable memory.

"The general conditions which governed our activities throughout 1916, if not substantially different from those of the previous year, showed a distinct tendency towards greater productiveness. Of course, the prolongation of hostilities brought certain unfavorable influences to bear upon the situation even more heavily than before. This was shown more particularly in the fluctuations in the purchasing power of money, the growing burden of taxation, the increased shortage of labor, the dearth of foodstuffs and raw materials and the deficiencies of shipping, etc. The country has, however, shown its ability to adapt itself to these adverse conditions, despite the further calls made upon it by the increased and varied requirements for war purposes."

The following is the statement of profit for the past year:

The net profit is	£523,583
which we propose to allocate as follows:	
To the extraordinary reserve fund	60,000
	£463,583
Four per cent. to the capital of £6,240,000	249,600
	£213,983
Seven per cent to the board of directors	14,978
leaving	£199,005
to which is to be added the amount carried forward from 1915....	20,101
making a total available of.....	£219,106
Out of which we propose paying a further dividend of three per cent.	187,200
leaving a balance to be carried forward of	£31,906

At December 31 the total assets of the bank were £117,677,827; the capital was £6,240,000, and deposits and current accounts, £47,887,826.

The head office of the Commercial Bank of Italy (Banca Commerciale Italiana) is at Milan, with numerous branches throughout the kingdom. A

London office is maintained at 1 Old Broad Street, under the management of E. Consolo.



Banking Amalgamation

THE Union Bank of Manchester has announced that it has concluded a provisional agreement for the acquisition of the business of the Halifax and District Permanent Banking Company, Ltd., at a cost of £112,500, which is to be paid in cash, thus avoiding any question of obtaining the sanction of the treasury committee, which it is likely would have been refused, inasmuch as the institutions are reputable concerns. The price to be paid represents a sum of £1 17s 6d for each Halifax £1 share, of which 10s has been paid up. In the last statement of accounts the paid-up capital was £15,000 and the reserve of an equal amount, but since then the paid-up amount has been increased to £30,000 and the reserve fund to £39,500. The Halifax Bank is an offshoot of the Halifax Permanent Building Society, which is the largest building society in the world. The bank was started eight years ago at Halifax, and branches have been opened at Bradford, Huddersfield, Keighley and Sheffield. Its progress has been very rapid and its depositors are in excess of half a million. The last dividend was at the rate of 17½ per cent. per annum, free of tax. It will thus be evident that the Manchester Bank is securing a sound and progressive business, and is also obtaining an entry into the industrial district which includes the West Riding of Yorkshire. The Halifax shareholders secure a good price for their shares, and both they and the depositors obtain the additional security given by an old-established institution with ample resources. The Union Bank of Manchester was founded in 1836 and has a subscribed capital of £1,250,000, of which £550,000, or £11 per £25 share, is paid up, and it has a reserve equal to the paid-up capital. Its dividend for 1916 was 12½ per cent., free of tax, follow-

MERCANTILE BANKING COMPANY, Ltd.

Avenida Francisco I. Madero No. 12

CITY OF MEXICO, D. F.

Capital and Surplus, \$600,000.00

GEO. J. McCARTY, President K. M. VAN ZANDT, Jr., Vice-President and Manager H. C. HEAD, Cashier FCO. COUDURIER, Asst. Cashier

Members: American Bankers' Association, Texas Bankers' Association, Mexico City Clearing House

GENERAL BANKING TRANSACTED TELEGRAPHIC TRANSFERS

Foreign Exchange Unsurpassed Collection Facilities Throughout the Republic

SEND US YOUR MEXICO BUSINESS

WRITE US UPON ANY SUBJECT WHICH MAY BE OF INTEREST TO YOU IN THE REPUBLIC OF MEXICO. P. O. Address: Apartado 1346.

ing on five years' dividend at the same rate, but less tax.



Latin-American Trade

ACCORDING to a forecast made by the National City Bank, trade between the United States and Central and South America will make a new record for the fiscal year ending June 30. The bank estimated that the total value of trade between this country and its Latin-American neighbors in the period would aggregate about \$1,500,000,000.

For the nine months ended with March, 1917, the imports into the United States from all Latin-America amounted to \$650,000,000, while exports from this country ran up to \$420,000,000, making a total of \$1,070,000,000. Commenting upon this year's gains, the bank's statement said:

"These figures show a marked increase over earlier years, the total imports of the nine months of last year having been but \$504,000,000 and the exports thereto \$294,000,000, making for the nine-month period but \$798,000,000 as against the \$1,070,000,000 in the nine months of this year. In the nine months ended with March, 1914, all of which preceded the war, the total imports and exports combined were but \$554,000,000, suggesting that our trade with the Latin-American countries in the fiscal year 1917 will be nearly three times as great as that immediately preceding the war."

The National Bank of South Africa, Limited

THE New York Agency of The National Bank of South Africa, Ltd., has received cable advice from its Head Office that at the annual meeting of shareholders held in South Africa the Hon. Hugh Crawford, chairman, reviewed the balance sheet figures, which are as follows:

Paid-up Capital.....	£2,850,000
Reserve	700,000
Notes in Circulation.....	1,789,387
Deposits	27,246,501
Cash Assets	7,477,843
Investments, written down to market value March 31st, 1917.....	3,292,030
Bills of Exchange.....	5,357,202
Total Liquid Assets.....	16,127,075
Bills Discounted, Loans, etc....	17,158,663

Mr. Crawford commented upon the healthy and decided increase shown in all departments of the bank. The net available profits amount to £418,634 after placing £30,000 in reduction of bank premises and providing for all bad and doubtful debts.

The board recommended a dividend of six per cent. absorbing with interim dividend already paid £169,500, and also recommended allocation of £175,000 to reserve fund and £25,000 to officers' pension fund, leaving £49,134 to be carried forward to next accounts.

The chairman spoke in confident and hopeful terms regarding the future of the bank and South Africa welcoming the growth in various new industries. He referred to the healthy position of

gold mining and also to agricultural progress and immense future for farming.



Remittances to American Military Men Abroad

THE London and Southwestern Bank, Ltd., head office, 170 Fenchurch street, London, E. C., announces to American banks and bankers that they have special facilities for making payments to American military and naval men and for general banking matters in all the allied countries.

Through their banking auxiliary, Cox & Co. (France), Ltd., they are in especial position to offer facilities in France, as Messrs. Cox & Co. have branches and correspondents at the chief military bases (branches at Paris, Havre, Marseilles, Rouen and Boulogne-sur-Mer), with agents in all parts of Great Britain, Spain, Italy, Portugal, Russia, Egypt and other countries.

The London and Southwestern Bank, Ltd., has a subscribed share capital of £3,000,000, and current deposits of about \$150,000,000. Sir Herbert Hambling, the general manager of the bank; Mr. John Caulcutt, the foreign manager, and the various partners of Cox & Co. in England and France, have travelled extensively in the United States and Canada and are well known to banking men.

A thorough acquaintance with the needs of the American travelers, and particularly the military men now going over, has resulted in the banks arranging all the facilities in foreign lands, which are so much appreciated by Americans sojourning abroad. Cox & Co. are the largest British army agents.



Australian Banking Figures

THE total of the balance sheets of the twenty-two ordinary banks in Australia, says the "Australian Banking and Insurance Record, is £279,430,113,

which shows a decrease of £9,085,786 as compared with the total published six months ago, but an increase of £3,863,675, as compared with twelve months ago. Adding the figures of the Commonwealth Bank (including its savings bank department), as at 30th June, 1916, the grand total is £321,202,467. The following is a comparison of the aggregates of the balance-sheets of the twenty-two banks, the Commonwealth Bank of Australia, and the combined totals for each half-year since 30th June, 1912:

	Twenty-two Banks £	Commonwealth Bank £	Combined Total £
June 30, 1912	245,494,516	245,494,516
Dec. 31, 1912	244,654,800	616,070	245,270,870
June 30, 1913	245,816,601	5,055,381	250,871,982
Dec. 31, 1913	248,033,361	6,558,975	254,592,336
June 30, 1914	262,240,714	9,773,690	272,014,404
Dec. 31, 1914	260,479,709	11,360,504	271,840,213
June 30, 1915	270,458,686	16,768,465	287,227,151
Dec. 31, 1915	275,566,438	23,933,408	299,499,846
June 30, 1916	288,515,899	41,772,354	330,288,253
Dec. 31, 1916	279,430,113	41,772,354*	321,202,467
*30th June.			



London and Brazilian Bank, Limited

THE London and Brazilian Bank, Limited, with head offices in London in the last annual statement as of January 31, 1917, has total resources of £19,233,296 and deposits of £8,602,123. The profit and loss account balanced at £799,636, with a gross profit of £799,636. This bank was established in 1862 and has a capital of £2,500,000.



Manchester and Liverpool Banking Company, Ltd.

THE report of the Manchester and Liverpool Banking Company, Limited, for the half-year ending December 30, 1916, showed total resources

of £41,806,569. The bank has deposits of £35,346,040 and a paid-in capital of £1,896,000, with a reserve fund of £1,200,000 and a reserve for depreciation of investments of £3,100,000. The profit and loss account balanced at £338,040 and showed expenses including salaries, etc., £131,775, and a gross profit after making provision for rebate on bills and for bad and doubtful debts, £334,470.



Commonwealth Bank of Australia

THE Commonwealth Bank of Australia, with head offices in Sydney, New South Wales, has total resources of £41,354,050 according to its last statement. Deposits are £29,320,549 and in the savings bank department they are £10,809,073. Profits for the half year are £153,072.



Mitsubishi Goshi, Kwaisha

THE banking department of this organization reports as of December 31, 1916: Capital, yen 1,000,000; deposits, 101,063,273; total assets, 115,517,850. This institution has its head office at Tokyo, with branches at Osaka, Kobe and Kyoto. Baron Koyata Iwasaki, president, and Baron Hisaya Iwasaki are the partners and Manzo Kushida and Kikuo Aoki, general managers.



A. I. B. Decides to Give Up Annual Convention

THE American Institute of Banking, with a membership exceeding twenty-three thousand bankers and bank men throughout the country, by vote of its executive council, has decided to do away with its big annual convention this year, which was scheduled to meet in Denver in September. This action has

National Bank of South Africa, Limited

THE National Bank of South Africa, Limited, in its last statement shows total resources of £32,471,298 and deposits of £23,157,243. The profit and loss account balances at £768,921 and the gross profit is £768,921. This bank has incorporated within it the Bank of Africa, Limited, established in 1879, the National Bank of the Orange River Colony, Limited, established in 1877, and the Natal Bank, Limited, established in 1854.



Bank of Liverpool, Limited

THE last statement of the Bank of Liverpool, Limited, which was established in 1831, shows total resources of £37,364,738 and deposits of £34,486,640. Total profits for the year are £437,965. The bank has a subscribed capital of £13,871,120 and a reserve fund of £900,000.



Remittances to American Forces

MR. APPLEBY, agent at New York of the Bank of British West Africa, Ltd., announces that the bank will be pleased to undertake remittances to the American forces both naval and military through the medium of their offices in London, Liverpool, Manchester and their agents in Paris.

been made necessary by the large number of bank men who have enlisted and it is expected that it will materially assist in conserving the working forces of the banks and trust companies.

President E. G. McWilliam in making the announcement stated:

"War conditions have placed upon the

banks of the United States an extraordinary amount of work, the details of which necessarily must be performed largely by the members of the American Institute of Banking.

"The number of institute members already in the service of the United States army and navy, and the greater number that doubtless will be called to such service in the near future, promise to create emergency conditions in the operation of most banks. The American banker and the American bank man realize that their first duty is to their country, and that in this crisis everything possible should be done which can in any way assist in hastening and insuring that victory which must be ours. The executive council of the American

Institute of Banking, therefore, has decided that it will be wise not to hold the elaborate convention which had been planned, but in its place, in order to comply with the constitution of the organization, to hold a simple one day session in Chicago on September 12, where each of the seventy-five chapters of the institute will be represented by a single delegate.

"In these strenuous days every one of us must do his part. The bank men of the country have never been known to shirk their duty and they propose to keep step with every patriotic plan and endeavor right straight through until *the world has been made safe for democracy.*"



"We Will Accommodate You"

A FEW banks still cling to the old idea that a bank is accommodating a patron by lending him money, thus putting him under an obligation.

Other banks have the correct perspective, which is, that a patron confers a favor on the bank when he accepts a loan of funds and pays interest for the use of the money. We must all recognize that banks cannot get along without the people, while the people could get along without the banks, even though they would be handicapped by that condition.

"We will accommodate you" is what a bank president once told a broad-minded, thorough business man who had just placed upon his desk accept-

able securities for a loan. To aggravate the situation, this president had thrust his thumb in the armholes of his vest importantly and swung back in his big swivel chair, half-turning to look at the patron condescendingly.

"No, you won't accommodate me," replied the business man. "Money a drug on the market, and the rate of interest you wish to charge me is not a shade less than a year ago; yet here I am offering you four times the security necessary. You are not doing me as much of a favor as I am showing you when I borrow some of your great surplus of idle money." And he picked up his securities, left the bank disgusted, and found the loan elsewhere.

Banking and Financial Industry

SPECIAL

The **BANKERS
MAGAZINE**

SECTION

IT is the aim of this department to make better known to each other the progressive banking and industrial institutions of the country.

This Magazine believes that by industry and economy, and by co-operation between all interests and sections of the country, the prosperity and happiness of the people of the United States may be advanced more rapidly, and to a greater extent, in the years lying immediately before us, than at any other time in the country's history.

How often the banker feels the desire and necessity for "getting out on the road" and making a grand tour of the banks of the country so as to get in touch with his contemporaries and broaden his outlook. Unfortunately, such an undertaking is generally impossible.

This Department seeks to take the place of such a trip by presenting to its readers instructive articles about banks and industrial institutions.



The New Addition to the Offices of Brown Brothers & Co., at 4 and 5 Hanover Street



The Present Offices (Old and New) of Messrs. Brown Brothers & Co. The main building was erected in 1865, and they have occupied offices there since that time



New Building for Brown Brothers & Co.

WE show herewith two illustrations of the new building recently completed for Messrs. Brown Brothers & Co., by the architects, Messrs. Delano & Aldrich. Although the new building provides an annex to the old quarters at No. 59 Wall street, it is treated as a separate structure with an entrance of its own on Hanover street.

While the architecture harmonizes to some extent with that of the old building, it is of a rather more distinctive type, somewhat Georgian in feeling. The building contains three floors and a basement. The exterior is of Georgia marble, of a light, warm gray color.

Entering from Hanover street, or from the public space in the old building, one passes into a small rotunda with a marble floor and cement walls. From this opens the elevator and a small lob-

by leading to the partners' office, which occupies most of this floor. This office, the main feature of the building, is a room about 23x40 feet. The walls are paneled in English oak up to the cornice and at one end is a mantel of Tinos marble. Across one side are four large windows and opening from it are two conference rooms so arranged as to be thrown into one, if desired. These conference rooms are also treated with wood panels in the Georgian manner and one of them contains an open fireplace with a mantel of Kingwood stone.

There is on this floor still a third conference room.

In the well-lighted basement are the postoffice, mailing department, rooms of the record clerk and stock clerk.

On the second floor are a private office and rooms both for the private sten-

ographers and the general stenographers, with a rest room.

The third floor is occupied by the accounting and bookkeeping department and the credit department.

The main banking floor and the second floor open directly into the corresponding floors of the old building which have been remodeled and on the first floor a new banking screen has been installed.

This building was done in record time by Messrs. Marc Eidlitz & Sons without disturbance or interruption to the banking business.

The completion of this building adds another dignified and appropriate structure to New York's financial district and affords the Messrs. Brown Brothers & Co. much needed space for their increased business. Furthermore, it is evidence that the firm recognizes the prudence of making adequate provision for the constantly enlarging demands of present-day business.

SKETCH OF THE FIRM

Brown Brothers & Co., merchant bankers, represent a type of financial organization more common in England and other European countries than here, and, indeed, the origin of the firm was British. Alexander Brown, of Belfast, Ireland, migrated to Baltimore in 1800, and established himself there as an im-

porter of Irish linens and other goods. His eldest son was established in business at Liverpool, which gave the firm the advantage of a direct European connection. At an early date a large business in sterling exchange was built up.

In 1818 Alexander Brown's third son, John, was sent to Philadelphia to open the house of John A. Brown & Co., and in October, 1825, James Brown, the youngest son of Alexander Brown, came to New York to establish a branch house under the name of Brown Brothers & Co. This was the beginning here of the present firm. An office had been opened at Boston in 1844. The London office was opened in 1863.

To trace the history of these various branches of the firm from the time the original house was established, more than a century ago, would require a volume. This record, if carefully followed, would show fidelity combined with a high degree of financial and commercial judgment and an unusual spirit of coöperation among those who founded this noted firm and those who in its long career have guided its affairs. It is certainly quite within bounds to say that the story of the rise and progress of this firm to its present eminent place constitutes a unique and honorable chapter in American banking history.





Scandinavian Trust Company—Public lobby and main banking room looking toward Broadway entrance—
Officers' quarters on right

New Foreign and Domestic Bank in New York

TO meet the increased banking and financial responsibilities of New York which have developed as a result of the war, special institutions are being organized. One of the latest of these is the Scandinavian Trust Company, chartered under the banking laws of the State of New York, and which opened for business at 56 Broadway on June 11 with paid-in capital and surplus of \$2,500,000.

The commerce between the United States and the Scandinavian countries is very large and its importance increases year by year. There are also very many people, both in New York and other parts of the country, of

Scandinavian birth who constitute an active, industrial and thrifty element of our national population. While it will be the aim of the new institution to supply the banking facilities demanded from the sources indicated above, for which the personnel and equipment assure a high degree of banking service, both foreign and domestic banking of all kinds will receive equally careful attention.

The tendency of international banking to develop along somewhat special lines is unmistakable, and where, as in this case, the personnel and equipment are such as to assure at the outset a high standard of safety and skill, the



Scandinavian Trust Company, 56 Broadway, New York City

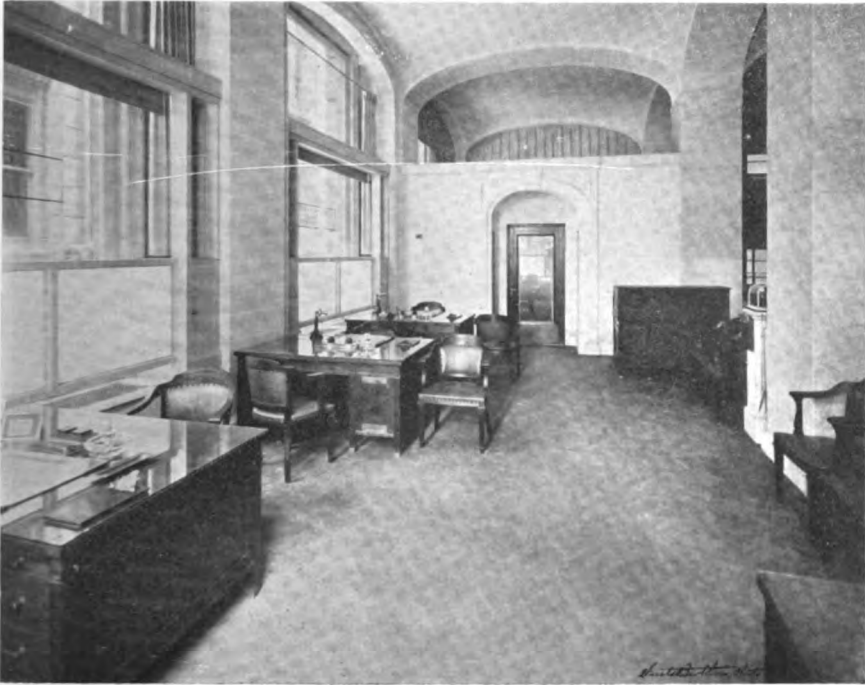

Officers' quarters, Scandinavian Trust Company

result must tend not only toward the success of the particular institution concerned, but must have an important bearing in enhancing American banking prestige.

The Scandinavian Trust Company owes its organization largely to Mr. Knut Bachke of the Andresen's Bank, Christiania, Norway, who has been prominent with other Norwegian capitalists in establishing somewhat similar institutions in London, Paris and Petrograd. Associated with Mr. Bachke are Mr. Anders Børresen, director of the Centralbanken for Norge, Christiania; Mr. G. Kamstrup Hegge of Den Norske Creditbank of Christiania, and Mr. S. E. Dahl of the Centralbanken for Norge, Christiania, these gentlemen comprising the Norwegian banking committee, prominent in the organization and management of the institutions above mentioned.

The connections of the Scandinavian Trust Company on the other side of the Atlantic are of a character which assures at once a wide and intimate relation with large European banking in-

terests. Both the official staff and the board of directors resident in this country represent extensive banking experience and financial relations of exceptional extent.

The executive head of the new institution is President Alexander V. Ostrom, formerly vice-president of the Northwestern National Bank of Minneapolis, which position he resigned to become president of the Scandinavian Trust Company. Mr. Ostrom has been in the banking business for eighteen years. Shortly after graduating from school he entered the Scandinavian-American Bank of Minneapolis as messenger, and was elected an assistant cashier of the Northwestern National Bank when that bank absorbed the Scandinavian-American in 1908. Five years later he was elected vice-president of the Northwestern National Bank.

B. E. Smythe, vice-president, is president of the Gramatan National Bank, Bronxville, N. Y., and the very high position he holds in banking circles is indicated by the fact that he was elected president of the New York



B. E. SMYTHE
VICE-PRESIDENT



T. BARTH
VICE-PRESIDENT



A. V. OSTROM
PRESIDENT



J. C. TRAPHAGEN
SECRETARY



D. CARDOZO
ASSISTANT SECRETARY

Officers of the Scandinavian Trust Company New York

State Bankers Association, presiding at the recent annual convention of that organization. His popularity among the bankers of New York, combined with large experience and sound judgment, will do much to build up the domestic branch of the new company's business.

T. Barth, vice-president, was formerly connected with the Royal Bank of Canada, and previously had been in the banking business in Paris, London, and at Bergen, Norway—experiences peculiarly fitting him for his present duties.

J. C. Traphagen, secretary of the company, was until recently assistant secretary of the Franklin Trust Company of New York, having supervision of the purchases and sales of the company's securities, and assisted in its reorganization work. Mr. Traphagen is a trustee of the American Savings Bank and a lecturer in the finance department of the New York University. His bond experience dates back to an early engagement with the bond house of George C. White & Co. In 1910 Mr. Traphagen was made manager of the Standard

Statistics Bureau, elected a director in 1914 and one year later was chosen its vice-president.

Danforth Cardozo has been connected with the Franklin Trust Co. for a number of years, having specialized in the credit and trust departments. He resigned as registrar of that company to associate himself with this new institution.

The directors of the Scandinavian Trust Company are:

Johs. Andersen, J. Andersen & Co.; Knut Bachke, Andresens' Bank, Christiania; Charles E. Bedford, vice-president Vacuum Oil Co.; James F. Bell, vice-president Washburn-Crosby Co., Minneapolis; John E. Berwind, vice-president Berwind-White Coal Mining Co.; R. R. Brown, first vice-president American Surety Co.; William R. Coe, chairman, Johnson & Higgins; Gerhard M. Dahl, vice-president Chase National Bank; S. E. Dahl, Centralbanken for Norge, Christiania; W. Edward Foster, treasurer American Sugar Refining Co.; Samuel L. Fuller, Kissel, Kinnicutt & Co.; Edward F. Geer, shipowner;



Main Banking Room and public space from Broadway entrance



KNUT BACHKE
Scandinavian Trust Company, New York



ANDERS BØRRESEN
Scandinavian Trust Company, New York

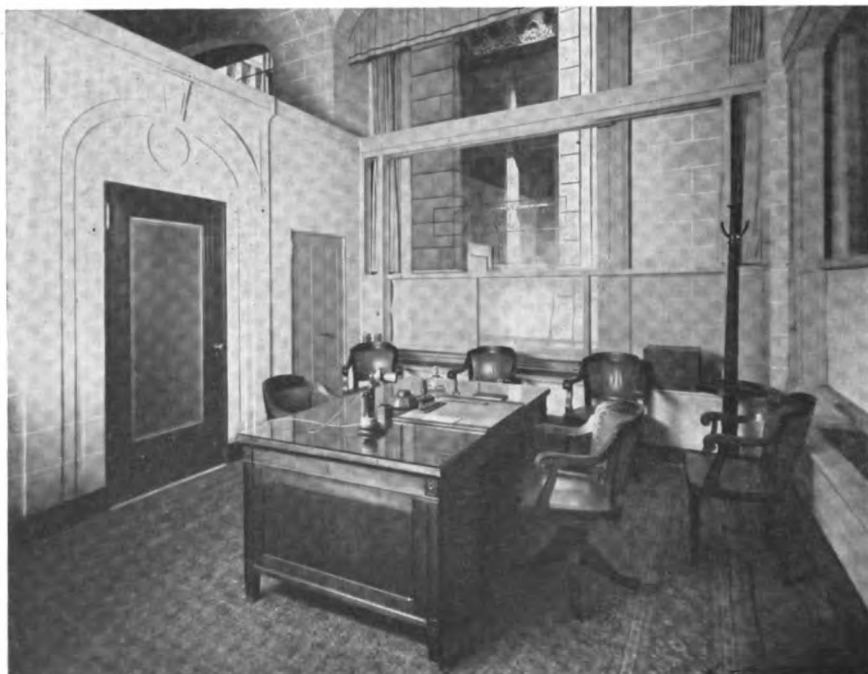

President's office, Scandinavian Trust Company, New York

Charles S. Haight, Haight, Sanford & Smith; G. Kamstrup Hegge, Den Norske Creditbank, Christiania; Edwin O. Holter, attorney; Frederick W. Hvoslef, Bennett, Hvoslef & Co.; N. Bruce MacKelvie, Hayden, Stone & Co.; Alexander V. Ostrom, president; Birger Osland, general western agent Norwegian-American Line, Chicago; E. A. Cappelen Smith, Guggenheim Brothers.

The location of the Scandinavian Trust Company at 56 Broadway, corner of Exchange place, is in the heart of New York's great financial district, and

especially favorable for the conduct of foreign as well as home banking business.

As will be seen from the accompanying illustrations, the new company has especially attractive quarters, combining all the essentials of safety and convenience.

Estimating all the company's component parts—the purpose for which it was organized, the banking and financial connections and experiences of its officers and directors—it would seem to start with every promise of large success.

The Astor Trust Office of the Bankers Trust Company

THE Bankers Trust Company's new banking room, at the southeast corner of Fifth avenue and Forty-second street, New York, is reached through a

classic granite portico with bronze doors, at the street level. Passing through the marble vestibule, a few steps above, one has a general view of the broad simple interior with its central space, enclosed by a lofty arcade of Hautville marble reaching to the classic cornice and richly coffered ceiling, thirty-five feet above. Two bronze electric chandeliers in the form of coronas and hung by chains, and richly embellished with ornamental crestings and pendants, furnish the general lighting of the room.

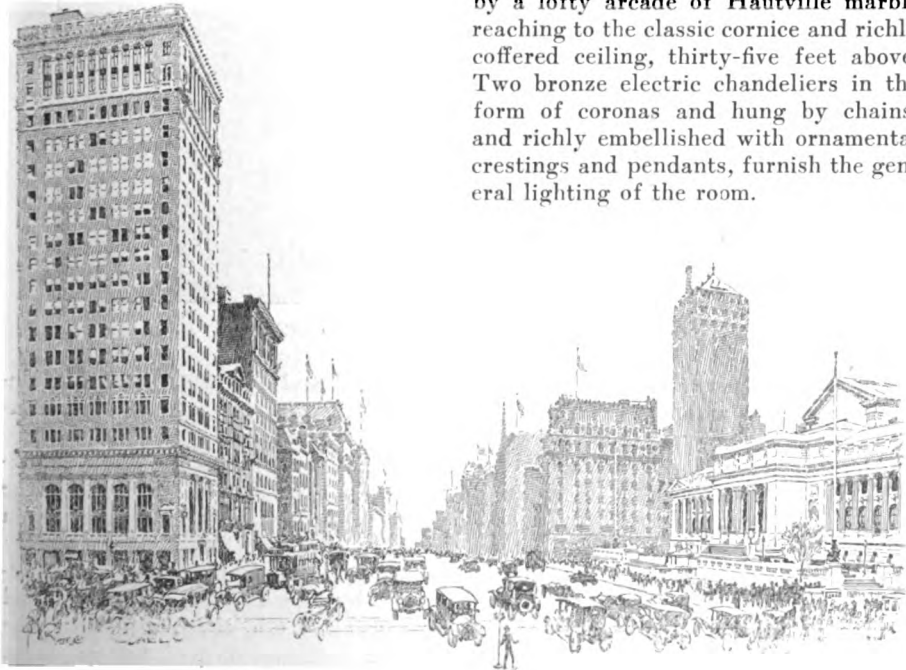



Astor Branch of The Bankers Trust Company, New York

At the level of about fifteen feet above the main floor is a mezzanine story extending around the entire room between the marble piers of the groined arcade. This is faced with a very richly designed entablature and railing with end pilasters of bronze. This same architectural treatment with the addition of bronze and glass grilles, forms two enclosures at either side of the entrance on a slightly higher level, one a direc-

tors' room and the other the ladies' department, with its own teller cage, writing desks, etc.

The entire mezzanine story is devoted to the clerical forces of the various departments on the main banking floor. These are directly underneath, and in close communication by dumbwaiter, telephone and dictagraph. On the main floor the various departments and tellers' cages

servicing the public are enclosed in classic bronze screens built in the form of bays, projecting slightly beyond the face of the marble piers and so placed as to compare in harmony and color with the mezzanine fascia and not interrupt the simplicity of the enclosing marble arcade and great pilasters. The bronze screen enclosing the working space is classic in design, treated in a

are always accessible to their patrons and by the latest devices of communication are in close touch with the clerical force.

The Astor Safe Deposit Company has its vaults in the basement. These are reached from the main banking room by a private elevator. This elevator is also accessible from the public hall of the building at the street level.



Main Banking Lobby, Astor Branch of The Bankers Trust Company, New York

delicate way with open arabesque panels and frieze with masques and replicas of Greek and American coins. The end pilasters of the bays are modelled in the form of Greek *termainae*.

In the centre of the public space is the officers' enclosure, surrounded by a low marble rail. This enclosure, furnished in every way to harmonize with the character of the large interior, in its color treatment, furniture and rugs, has a more intimate atmosphere. The officers of the bank by this arrangement

The public space of the safe deposit department is entered from the private elevator through a steel grilled door, and provided with steel coupon booths of various sizes and a special security counting room.

The vault is of the most approved type; has linings two and one-half inches thick and is provided with one round door sixteen inches thick, with raising and lowering device for the platform for the safe deposit department, and a rectangular, round cornered

door sixteen inches thick opening into the compartment in which the bank's securities are stored. It is built of manganese steel throughout. Both doors are equipped with twenty-four holding bolts, three and one-half inches in diameter, controlled by two tumbler combination locks and the latest type seventy-two hour quadruple time locks. These doors are swung on manganese crane hinges with bearings of manganese steel, integral with vestibule body and door.

Steel grilles with Yale locks protect both openings when the doors are open. The entire vault, with the exception of the doors, is encased in eighteen

inch concrete, reinforced with twisted steel bars. It is further protected by polished steel panelings, which in turn cover a complete Holmes electric protective system.

The interior of the vault in one portion is equipped with steel safe deposit boxes of various sizes. This is separated by steel grilles from the security vault, which is provided with heavy steel safes for the protection of the bank's funds and records.

A duplicate lighting system is provided throughout the basement; in the vault, the safe deposit department and its archives, and also in the adjoining lavatories and locker rooms.



The Root Commission in Russia

THE admirable utterances of Mr. Root in Russia, and the good sense shown by the American commission to that country, brought deserved praise from the American press last month. Mr. John F. Stevens and his group of railway men were welcomed as helpers in the solution of Russia's transportation problems. A Russian mission meanwhile had arrived in the United States, and it was received with especial marks of consideration at Washington. All sorts of efforts are being made to find grounds of common understanding, for the present and for the future, between Russia and the United States. Undoubtedly, as a result of Mr. Root's presence in Petrograd, and other opportunities for conference, there will be ample opportunity for the United States to have an influential part in the decisions of the conference that Russia and her European allies will hold over a revision of agreements and a restatement of the

war's objects. When Secretary of State, Mr. Root showed not merely a high order of talent, but above all he showed a sympathetic ability to grasp the point of view of other nations. He smoothed out differences with Canada because he was willing to see the Canadian viewpoint, while Ambassador Bryce was equally willing to see ours. Mr. Root had the confidence and the good will of the South American governments because of his solicitude for their progress and welfare, and his courteous treatment of their representatives. He has known how to express the best American feeling and sentiment towards Russia; and his attitude is in precise accord with that of President Wilson and Secretary Lansing. We may hope, therefore—as well as ardently desire—that great good may come of the Russian mission.—From "The Progress of the World," in the "American Review of Reviews" for July, 1917.



New York Agency, Union Bank of Canada, 49 Wall Street

Union Bank of Canada

CANADIAN banks, on account of their large capital and resources and the adaptability of their organizations, have branched out in other lands than their own much earlier and more extensively than American banks have done. For a long time several of the leading Canadian banks have been represented in New York and other financial centres in the United States either by branches or agencies. This course was made desirable and even necessary by the very close commercial and financial relations existing between the United States and the Dominion of Canada, relations which have been very much enlarged since the European war began.

One of the most recent extensions of Canadian banking into this country was made by the Union Bank of Canada,

which opened an agency in New York in April of the present year at No. 49 Wall street.

Mr. Geo. Wilson, who is First Agent, is an Englishman by birth. Before taking the New York appointment he was six years manager of the Toronto branch of the Union Bank of Canada, and previous to that was twenty years with the Imperial Bank of Canada.

Mr. F. T. Short is also an Englishman and was formerly manager of the branch of the bank at St. John, N. B.

The fact that this institution has now become directly identified with banking in this country will render a sketch of the bank's history of interest to the readers of this MAGAZINE.

The Union Bank of Canada, although just now beginning to participate directly in banking in this country, is by



GEO. WILSON
 First Agent Union Bank of Canada, 49 Wall St.,
 New York



Quebec Branch, Union Bank of Canada
 (Formerly Head Office)



Toronto Branch, Union Bank of Canada

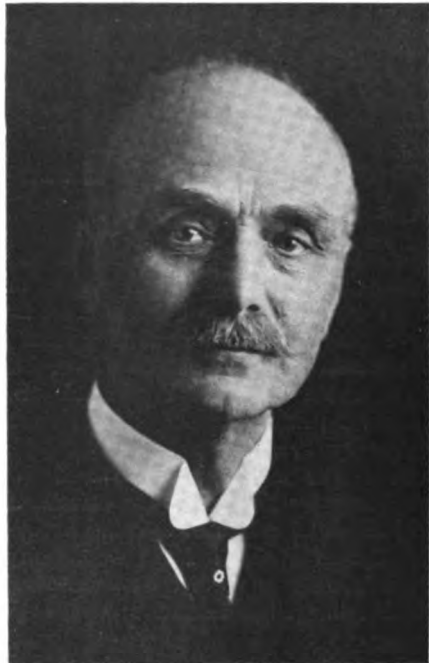

F. T. SHORT
 Second Agent Union Bank of Canada, 49 Wall St.,
 New York



Head Office, Winnipeg, Union Bank of Canada

no means a new bank, for it dates back to 1865, when it was incorporated by an act of the Provincial Parliament of Canada, under the name of the Union Bank of Lower Canada, with its head office in Quebec.

In 1867, confederation of the various provinces of Canada having taken place, all the chartered banks came under the Federal Bank Act.

For some years the operations of the bank were confined to the Province of Quebec, but gradually their scope increased until in 1885 it was deemed advisable to secure from the Dominion Parliament permission to change the name of the bank to the Union Bank of Canada.

About this time there was a striking development of the Northwest Provinces, of which the bank took advantage by opening a number of branches in that new portion of Canada. This policy, due in great measure to the president, Mr. Andrew Thomson, and the general manager, Mr. E. E. Webb, proved most successful. As time has gone on, the

needs of the country growing, new branches have been opened, until at the present time there are no less than 205 west of Fort William, Ont., at the head of the Great Lakes, to Victoria, B. C. So much of this territory has been covered by the bank that it well may lay claim to being the Pioneer Bank of the West.

In Ontario its operations also were gradually extended and in 1911 the absorption of the United Empire Bank of Canada took place, which benefited the bank greatly through the acquisition of some twenty branches in the richest part of Ontario where the Union Bank was not previously represented.

In the year 1912 the head office of the bank was moved from Quebec to



Montreal Branch, Union Bank of Canada

Winnipeg, Manitoba, Mr. John Galt, one of the most prominent merchants of that city, being appointed president in the place of Hon. John Sharples, who resigned on account of ill health. Under the direction of Mr. G. H. Balfour, the general manager, who succeeded Mr. Webb in 1904, and remained in office until the spring of 1917, the bank's business increased almost fivefold. On Mr. Balfour's retirement, Mr. H. B. Shaw, one of the most active and best-known bankers of Western Canada, who had been in the service for more than twenty years, was appointed in his stead, with Mr. J. W. Hamilton as his assistant.

In 1911 a branch of the bank was established in the city of London, England, under the management of Mr. F. W. Ashe, which proved such a success that it was deemed advisable to open another in the Haymarket, West End.

The position of the bank with respect to its ability to render service over a wide territory appears from the fact that its connections now comprise 310 branches in Canada, two in London, and an agency in New York.

How the bank has grown may be seen by a glance at the accompanying figures, which show the increase in the number of branches, capital and reserves, circulating notes, deposits and total assets, from 1895 to 1916.

	1895.	1916.
Branches	21	310
Capital and reserve.	\$1,460,000	\$8,400,000
Notes in circulation	817,000	8,815,000
Deposits	4,904,000	89,267,000
Total assets	7,802,000	109,040,000

This growth affords an evidence of the prosperity of the country and especially illustrates the adaptability of the bank to the constantly increasing need of banking facilities.

The Union Bank of Canada has been especially fortunate in the selection of its directors, who are all representative business men from the larger cities, the board of directors being composed of: Lt.-Col. Sir William Price, honorary president; John Galt, Esq., president; R. T. Riley, Esq., vice-president; G. H. Thomson, Esq., vice-president; W. R. Allan, Esq., Winnipeg; Major Hume Blake, Toronto; M. Bull, Esq., Winnipeg; Maj.-Gen. John W. Carson, C. B., Montreal; B. B. Cronyn, Esq., Toronto; E. L. Drewry, Esq., Winnipeg; Stephen Haas, Esq., Toronto; J. S. Hough, Esq., K. C., Winnipeg; F. E. Kenaston, Esq., Minneapolis; R. O. McCulloch, Esq., Galt; and Wm. Shaw, Esq., Quebec.

A most satisfactory feature in connection with the London and New York offices is the representative character of the advisory committees in these places, the members in London being Lt.-Col. J. Leigh Wood, C. M. G.; Lt.-Col. the Hon. Sidney Peel, and F. W. Ashe, Esq.; and in New York, Stuyvesant Fish, Esq.; Gilbert G. Thorne and Lt.-Col. Cornelius Vanderbilt.

At the present time three directors and three members of the advisory committees are in khaki, Maj.-Gen. Sir John W. Carson, C. B., having recently been knighted by his Majesty the King for services in London as representative of the Canadian War Office. The employees of the bank have given their full measure of service in the war, seven hundred and fifteen having enlisted and gone overseas. Of these, latest reports show that fifty-five have been killed in action and a large number wounded.

The condition of the bank at the date of the half-yearly report, November 30, 1916, is shown in the annexed statement.

PROFIT AND LOSS ACCOUNT, NOVEMBER 30, 1916.

Balance at credit of account, November 30, 1915.....	\$106,976.75
Net profits for the year, after deducting expenses of management, interest due depositors, reserving for interest and exchange, and making provision for bad and doubtful debts and for rebate on bills under discount, have amounted to	651,183.67

\$758,160.42

Which has been applied as follows:

Dividend No. 116, two per cent., paid March 1, 1916.....	\$100,000.00
Dividend No. 117, two per cent., paid June 1, 1916.....	100,000.00
Dividend No. 118, two per cent., paid September 1, 1916.....	100,000.00
Dividend No. 119, two per cent., payable December 1, 1916.....	100,000.00
Bonus of one per cent., payable December 1, 1916.....	50,000.00
Transferred to Contingent Account	150,000.00
Contribution to Officers' Pension Fund.....	10,000.00
Contribution to British Sailors' Relief Fund.....	5,000.00
War tax on bank note circulation to November 30, 1916.....	50,000.00
Balance of Profits carried forward.....	93,160.42

\$758,160.42

LIABILITIES, NOVEMBER 30, 1916.

Capital stock		\$5,000,000.00
Rest account	\$3,400,000.00	
Balance of profit and loss account carried forward.....	93,160.42	

\$3,493,160.42

Unclaimed dividends	4,013.53
Dividend No. 119, payable December 1, 1916.....	100,000.00
Bonus of one per cent., payable December 1, 1916.....	50,000.00

3,647,173.95

\$8,647,173.95

Notes of the bank in circulation.....	\$8,815,117.00
Deposits not bearing interest.....	29,122,848.51
Deposits bearing interest	60,144,940.61
Balances due to other banks in Canada.....	320,936.02
Balances due to banks and banking correspondents elsewhere than in Canada	1,476,235.12

99,880,077.26

Acceptances under Letters of Credit.....	512,281.39
Liabilities not included in the foregoing.....	695.50

\$109,040,228.03

ASSETS NOVEMBER 30, 1916.

Gold and silver coin	\$3,139,492.26
Dominion Government notes.....	6,965,529.00

\$10,105,021.26

Deposit with the Minister of Finance for the purposes of circulation fund..	260,000.00
Deposit in the Central Gold Reserves.....	4,700,000.00
Notes of other banks.....	937,860.00
Cheques on other banks.....	4,016,138.02
Balances due by other banks in Canada.....	49,872.56
Balances due by banks and banking correspondents elsewhere than in Canada	700,455.05
Dominion and Provincial Government securities not exceeding market value	2,100,547.50
Canadian Municipal securities, and British, foreign and Colonial public securities other than Canadian.....	14,445,701.09
Railway and other bonds, debentures, and stocks not exceeding market value	3,170,871.47
Call and short (not exceeding thirty days) loans in Canada, on bonds, debentures and stocks	7,616,488.64
Call and short (not exceeding thirty days) loans elsewhere than in Canada...	8,484,897.00

\$56,587,852.59

Other current loans and discounts in Canada (less rebate of interest)....	49,173,367.16
Other current loans and discounts elsewhere than in Canada (less rebate of interest)	846,117.55
Liabilities of customers under Letters of Credit, as per contra.....	512,281.32
Real estate other than bank premises.....	355,982.24
Mortgages on real estate sold by the bank.....	104,404.03
Overdue debts, estimated loss provided for.....	341,352.87
Bank premises, at not more than cost, less amounts written off.....	1,106,255.38
Other assets not included in the foregoing.....	12,614.89

\$109,040,228.03



Home of the Industrial Trust Company, Providence, R. I.

The Industrial Trust Company, Providence, R. I.

AUGUST 1, 1917, marks the thirtieth anniversary of the founding of the Industrial Trust Company of Providence, R. I., which was incorporated by the General Assembly of the State of Rhode Island June 9, 1886, and commenced business August 1, 1887. The capital was originally \$500,000. This has been increased to \$3,000,000, with a surplus of \$1,000,000 and undivided profits of nearly \$1,000,000. The last published statement, under date of April 14, 1917, gives the following excellent showing and establishes the company's title as

the largest banking institution in the State of Rhode Island:

RESOURCES

Loans and Discounts.....	\$26,780,597.51	
Real Estate Mortgages.....	4,461,106.99	
Bonds and Stocks.....	19,190,028.31	
Banking Houses.....	870,000.00	
Building Alteration Account..	17,261.10	
New Building Account.....	74,659.59	
Call Loans.....	\$8,685,262.00	
Due from Banks, Bankers and U. S. Treasurer....	7,604,262.15	
Cash.....	3,438,333.98	
		\$19,727,858.13
		\$71,121,511.63



SAMUEL P. COLT

Chairman of the Board Industrial Trust Company,
Providence, R. I.



H. MARTIN BROWN

President Industrial Trust Company,
Providence, R. I.

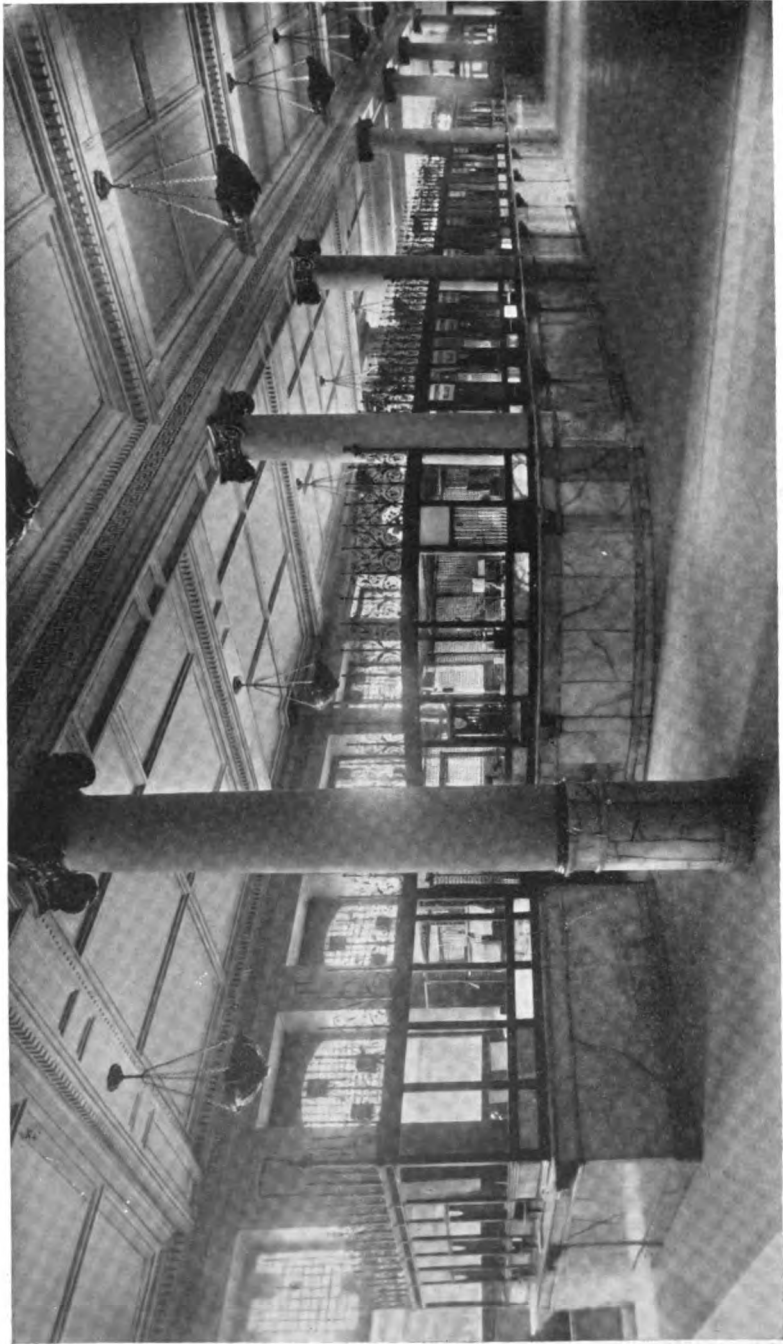

Main Banking Room, Industrial Trust Company, Providence, R. I.



Trust Department, Industrial Trust Company, Providence, R. I.

LIABILITIES

Capital Stock	\$3,000,000.00
Surplus	4,000,000.00
Undivided Profits	989,196.47
Reserved for Interest, Taxes, etc.	455,755.89
Deposits	62,676,559.27
	<hr/>
	\$71,121,511.63

The present officers are: Samuel P. Colt, chairman of the board of directors; H. Martin Brown, president; Joshua M. Addeman, vice-president; James M. Scott, vice-president; Frank C. Nichols, vice-president; Samuel M. Nicholson, vice-president; Ward E. Smith, treasurer; Henry B. Congdon, secretary; J. Cunliffe Bullock, trust officer; Elmer F. Seabury, assistant treasurer; Harry C. Owen, assistant secretary; Henry C. Jackson, assistant secretary.

Board of directors: Samuel P. Colt, chairman; Joshua M. Addeman, James M. Scott, H. Martin Brown, J. Milton Payne, Eben N. Littlefield, Ezra Dixon, Lyman B. Goff, Samuel M. Nicholson, James R. MacColl, Harold J. Gross, R.

Livingston Bceckman, Walter S. Bal-lou, Albert H. Sayles, Henry W. Har-vey, James M. Pendleton, Thomas P. Peckham, Everett I. Rogers, Frank C. Nichols, Erling C. Ostby, John S. Hol-brook, Edward H. Rathbun, Henry A. Hoffman, Alfred M. Coats, Frank L. Pierce, Edward B. Aldrich.

The first officers of the company were Samuel P. Colt, president, and Joshua M. Addeman, treasurer. Colonel Colt had served the state in various capaci-ties, notably as its Attorney General, and Mr. Addeman had been repeatedly elected as Secretary of State. Both gentlemen were widely and favorably known throughout the state. Colonel Colt's subsequent connection with many business interests and his notable suc-cess as president of the United States Rubber Company have gained for him a national reputation.

The company's building in Provi-dence is located at the corner of West-minster and Exchange Streets, extend-ing through to Exchange Place, and



JOSHUA M. ADDEMAN
Vice-President Industrial Trust Company,
Providence, R. I.

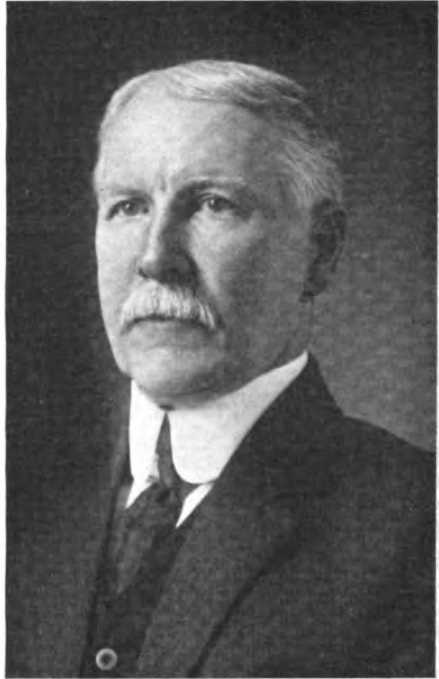

JAMES M. SCOTT
Vice-President Industrial Trust Company,
Providence, R. I.



FRANK C. NICHOLS
Vice-President Industrial Trust Company,
Providence, R. I.



SAMUEL M. NICHOLSON
Vice-President Industrial Trust Company,
Providence, R. I.



WARD E. SMITH
Treasurer



HENRY B. CONGDON
Secretary



J. CUNLIFFE BULLOCK
Trust Officer

Industrial Trust Company, Providence, R. I.

covers an area of 16,000 square feet. It is nine stories high. Originally the company occupied only part of the street floor, but in 1916 the growth of its business made it necessary for it to increase the space occupied by it. Up to that time a portion of the street floor of the building had been rented to a national bank. This space was taken by the company for its own use, as a result of which extensive alterations were made. The entire street floor of the building, with the exception of that portion which is occupied by its subsidiary company, the Rhode Island Safe Deposit Company, is now being utilized, in addition to which practically the whole of the floor next above is occu-

ried by the company for directors' rooms, offices and for its bookkeeping and check tellers' departments. The banking rooms are believed to be unsurpassed in New England, for their spacious effect, mural decorations, lighting devices and convenient facilities for customers, officials and clerks.

The growth of the business of the company throughout the state made it desirable to establish branches at Pawtucket, Newport, Woonsocket, Bristol, Warren, Pascoag, Wickford and Westerly, nearly all of which have independent boards of managers, comprising prominent business men of their respective communities. The company owns the buildings occupied by the



ELMER F. SEABURY
Assistant Treasurer



HARRY C. OWEN
Assistant Secretary



HENRY C. JACKSON
Assistant Secretary

Industrial Trust Company, Providence, R. I.

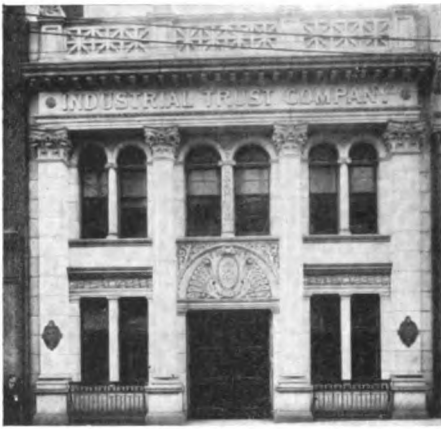

Pawtucket

Wickford



Woonsocket

Bristol

Exterior and Interior Views of Branch Buildings of the Industrial Trust Company, Providence, R. I.

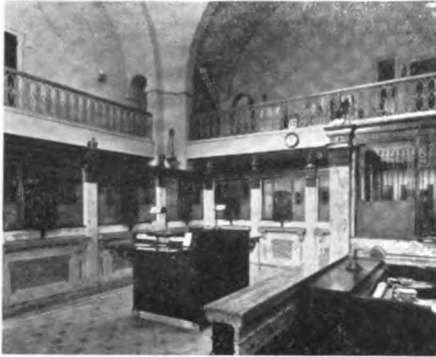

Westerly

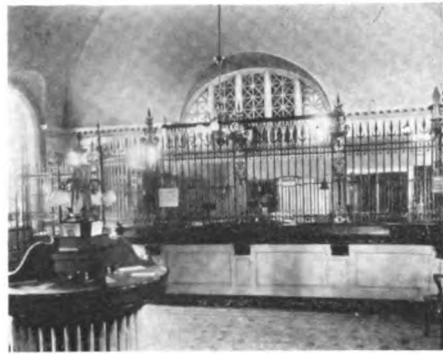

Warren



Pascoag



Building of The Newport Trust Company, Newport, R. I., in which the Newport Branch is located

branches in Pawtucket, Warren, Westery and Wickford, all of which are of fine architectural design and interior finish. It also leases suitable quarters for its business in the other localities, named.

Some idea of the growth of this company during the thirty years it has been in existence may be gained from the

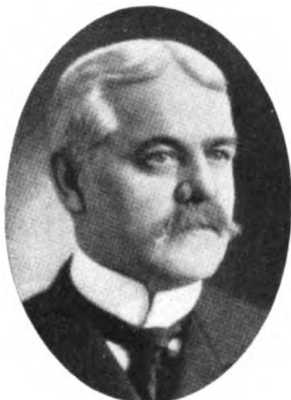

THOMAS P. PECKHAM
Newport



JOHN N. EATON
Pawtucket



E. C. FRANCIS
Woonsocket



CLINTON T. SHERMAN
Bristol



EDWIN A. CADY
Warren



EARLE D. STEERE
Pascoag



JAMES M. PENDLETON
Westerly



THADDEUS W. HUNT
Wickford

Branch Managers, Industrial Trust Company, Providence, R. I.

following table of comparative deposits at the close of each year:

Dec. 31, 1887.....	\$188,731.11
Dec. 31, 1888.....	1,108,419.04
Dec. 31, 1889.....	1,735,053.59
Dec. 31, 1890.....	2,036,599.20
Dec. 31, 1891.....	2,484,465.48
Dec. 31, 1892.....	4,867,968.22
Dec. 30, 1893.....	3,424,957.45
Dec. 31, 1894.....	3,943,084.49
Dec. 31, 1895.....	4,658,022.16
Dec. 31, 1896.....	4,897,089.69
Dec. 31, 1897.....	5,032,855.85
Dec. 31, 1898.....	6,733,480.51
Dec. 30, 1899.....	8,066,506.79
Dec. 31, 1900.....	11,395,529.67
Dec. 31, 1901.....	12,914,319.98
Dec. 31, 1902.....	21,198,771.69
Dec. 31, 1903.....	21,648,980.80
Dec. 31, 1904.....	38,865,890.78
Dec. 30, 1905.....	40,238,615.66
Dec. 31, 1906.....	43,144,273.45
Dec. 31, 1907.....	38,473,518.38
Dec. 31, 1908.....	38,046,082.81
Dec. 31, 1909.....	40,511,191.74
Dec. 31, 1910.....	41,554,402.87
Dec. 31, 1911.....	43,384,721.56
Dec. 31, 1912.....	45,339,918.64
Dec. 31, 1913.....	46,645,321.18
Dec. 31, 1914.....	46,826,732.62
Dec. 31, 1915.....	53,863,650.43
Dec. 30, 1916.....	58,977,248.14
April 14, 1917.....	62,676,559.27

The safe deposit business of the company is done through the Rhode Island Safe Deposit Company, which was established in 1873, thus making it the

oldest safe deposit company in the state. It has a paid-in capital of \$100,000 and is controlled by the Industrial Trust Company. The Safe Deposit Company has from time to time in the past found it necessary to increase its facilities substantially and now has an immense safe deposit vault 22x25 feet, which is built on the first floor so that it may be seen from all four sides. There are two doors to the vault, enabling customers after entering the vault and obtaining their boxes to pass through the second door into the coupon rooms. The vault walls are of 20-inch concrete, lined with a grill cage, which is further re-enforced with a 4-inch solid steel drill and explosive proof backing. The vault is one of the strongest and most modern in the country. The two main doors weigh twenty-three tons each. The Safe Deposit Company, in addition to the large vault on the first floor, has one of equal size in the basement, which is used for the storage of silver and other valuables.

The facilities and equipment of the company in all departments are unsurpassed. Officered by men of proved ability, and backed by resources of more than seventy millions, it is able and willing to care for the needs of its customers along any lines.



WITH a systematic teaching of thrift, we would find that the young men and women graduated from our schools would be, not dependent, but dependable men and women, who would be made into sterling citizens with full cognizance of the value of money and its earning power.

—FRANK C. MORTIMER



A. W. NAYLOR
President First National Bank, Berkeley, Cal.



F. L. NAYLOR
Vice-President First National Bank, Berkeley, Cal.



W. F. MORRISH
Cashier First National Bank, Berkeley, Cal.

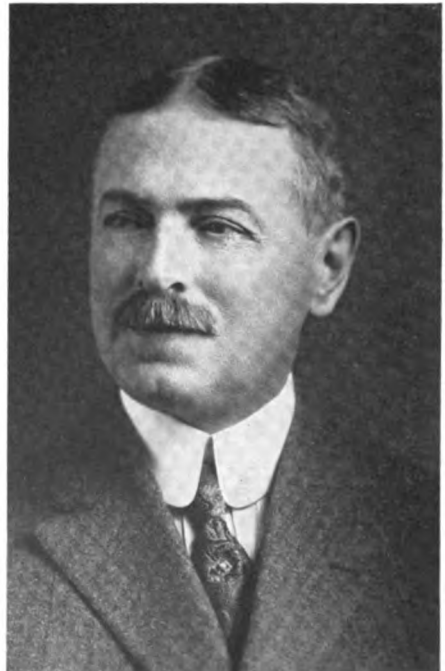

W. S. WOOD
Cashier and Trust Officer Berkeley Bank of Savings
and Trust Company, Berkeley, Cal.



First National Bank, Berkeley, Cal.

Strong Banking Combination in Berkeley, Cal.

TWENTY-FIVE years ago the city of Berkeley, Cal., was without banking facilities. To-day it is served by one of the largest banks in the state outside of the larger cities, the First National Bank of Berkeley and its affiliated institution, the Berkeley Bank of Savings and Trust Company.

The First National Bank of Berkeley was founded originally as the Commercial Bank of Berkeley and was organized by F. K. Shattuck and A. W. Naylor, who held the respective offices of president and cashier. At the time of this organization many good citizens were inclined to doubt the wisdom of such a banking enterprise, but through



G. L. PAPE
First Assistant Cashier First National Bank,
Berkeley, Cal.



F. H. THATCHER
Second Assistant Cashier First National Bank,
Berkeley, Cal.

the careful and conservative management of Mr. Shattuck and Mr. Naylor the bank proved successful from the start and amply justified the wisdom of its founders.

It was first located in modest quarters in a rented building, but in 1905, in order to provide better facilities for its rapidly increased business, the bank moved to its present location on the corner of Center street and Shattuck avenue. This building was the first of its kind in Berkeley and is thoroughly modern and complete in its equipment.

At the time of its construction it was thought by the officers of the bank that the building would be plenty large enough to accommodate them over a period of from fifteen to twenty years. But in 1909 the space was so crowded that it was found necessary to purchase the adjoining property and erect the savings bank addition. Since then several minor alterations have been made and to-day the bank still finds itself

cramped for room and at present plans are being considered for further additions.

POLICY OF EXPANSION

On August 1, 1910, for the convenience of the bank's customers in the eastern part of the city, and for the students of the University of California, the Telegraph Avenue Branch of the Berkeley Bank of Savings and Trust Company was founded. The success of this branch was assured from the start and to-day, under the capable management of G. T. Douglas, it has become an important factor in the development of that section of Berkeley.

In January, 1916, the South Berkeley Bank was absorbed and is now being operated as a branch of the Berkeley Bank of Savings and Trust Company under the able management of F. K. Cole, its former cashier.

In September, 1916, the Homestead Bank was absorbed and F. H. Thatcher,



G. T. DOUGLAS

Manager Telegraph Avenue Branch, Berkeley Bank of Savings and Trust Co., Berkeley, Cal.



A. H. SHEFFIELD

Assistant Cashier Berkeley Bank of Savings and Trust Company, Berkeley, Cal.

its cashier, was made an assistant cashier of the First National Bank of Berkeley.

That this policy of expansion and absorption has been a profitable one for the bank is shown by the fact that at the present writing the latter is carrying 27,000 accounts on its books, including those in the main bank and in the branches. As the population of Berkeley is about 65,000, it will be seen that the bank has an average of one account for every two and one-half people in the city. The total resources of all the banks in Berkeley are about \$15,500,000. The First National Bank and its affiliated institution have resources of \$12,500,000, or about eighty per cent. of the entire banking resources of the community.

Much of the success of the First National Bank of Berkeley may be attributed to the efficiency of its organization and the completeness of its service to its depositors. A good example of this

is seen in the promptness with which this bank adopted modern bookkeeping machinery in order to speed up the work of the bank and assure its customers the maximum of convenience and satisfaction in the handling of their financial affairs. The bank was also quick to realize the advertising value of the installation of its bookkeeping machinery and made good use of this in all of its advertising copy. There can be no doubt that many new accounts were attracted to the bank because of the feeling that its modern facilities would assure depositors perfect banking service.

The First National Bank is the only national bank in Berkeley, and the only Berkeley member of the Federal Reserve System. Its officers have always been deeply interested in the development of Berkeley and in this development the bank has played an important part during the past quarter century.

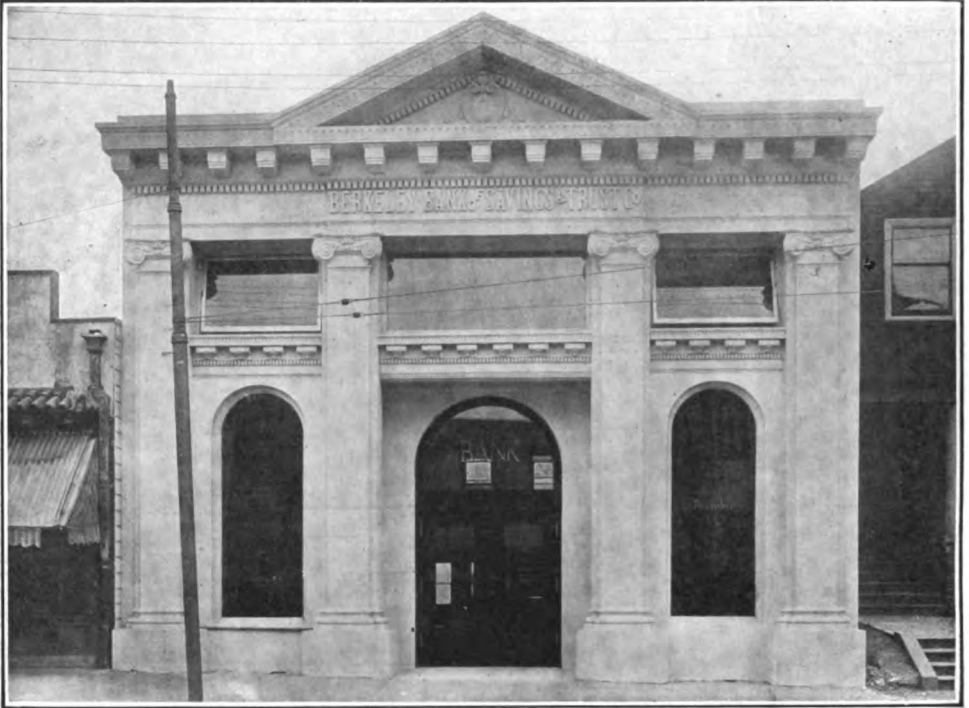

Telegraph Avenue Branch, Berkeley Bank of Savings and Trust Company

PERSONNEL OF THE BANK

It will be interesting at this point to tell briefly of the men whose efforts have built up the First National Bank and whose abilities have placed it on such an efficient footing to-day:

As president of the First National Bank and the Berkeley Bank of Savings and Trust Company, Addison Wood Naylor occupies a prominent place in the citizenship of Berkeley. Mr. Naylor is a native of Morgan County, Ohio. After graduating from the Iron City College at Pittsburgh, Pa., he located in New Sharon, Iowa, and there engaged in a general dry goods store for about ten years. Later disposing of his interests in New Sharon, and moving to Des Moines, he assisted in the organization of the Capital City State Bank, of which he became the first president. Coming to California he located in various places until 1891, when he moved to Berkeley, and with F. K. Shattuck organized the Commercial Bank, which is now the First National Bank and Berkeley Bank of Savings and Trust Company. He held the position as cashier of both institutions until the death of Mr. Shat-

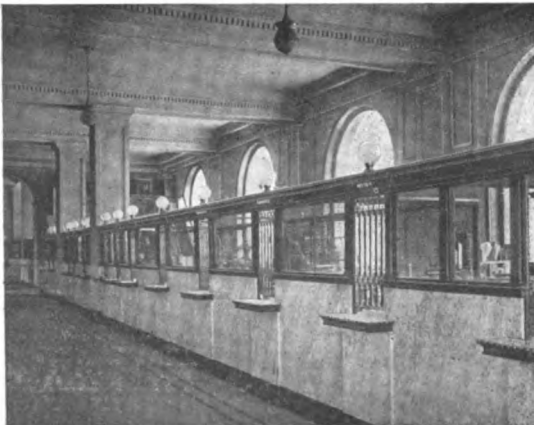

Main Banking Room, First National Bank, Berkeley, Cal.

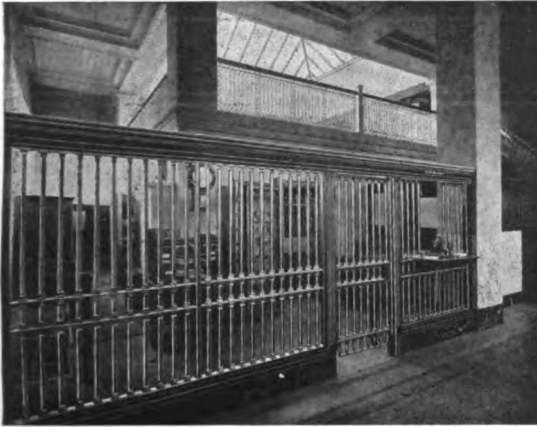

Safe Deposit Vaults, First National Bank, Berkeley, Cal.

tuck in 1898, at which time he became the president.

F. L. Naylor, vice-president of both the First National Bank and Berkeley Bank of Savings and Trust Company, entered in the employ of the Central National Bank in 1893, where he remained three years. In 1896 he was appointed assistant cashier of First National Bank and Berkeley Bank of Savings and Trust Company. In 1898 was elected cashier of both institutions, which position he held for ten years. In 1908 he was elected vice-president.

W. F. Morrish was formerly assistant cashier and was appointed cashier in the Fall of 1916, to succeed F. C. Mortimer, the former cashier.

Mr. Morrish first entered the employ of the First National in 1904, when he started his banking career as a messenger. Previous to this Mr. Morrish was connected with the Southern Pacific Co., having studied for a time at the University of California. In 1911 he was elected an assistant cashier of the First National.

Mr. Morrish was a charter member of the Oakland Chapter of the American Institute of Banking and has served three years as a member of its board of governors. At this time he was instrumental in making arrangements with the Extension Division of the University of California to carry on the educational work of the chapter.

Mr. Morrish has always been a

strong believer in educational work among bank employees and has himself taken a two-year course in banking and commercial law, and holds a diploma from the American Bankers Association. He has been very active in the work of the A. I. B., and has served as a delegate to several of its conventions. Mr. Morrish is also interested in all matters pertaining to civic betterment, and is a member of the Chamber of Commerce and several other clubs and organizations.

W. S. Wood is cashier and trust officer of the Berkeley Bank of Savings and Trust Company. He was with the Middlesex Banking Company (farm loans) at St. Paul, Minn., from 1886 to 1902, and came to California in May, 1902. He was a private secretary until May, 1903, when he entered the University Savings Bank as receiving teller. Mr. Wood was with the First National Bank of Berkeley from October, 1903, to October, 1907, when he was elected trust officer of the Savings and Trust Company. In 1909 he was made assistant cashier, and in 1912 cashier.

G. L. Pape, assistant cashier of the First National Bank, is one of the early residents of Berkeley, having gone there with his parents from New York in 1885. After graduating from the Berkeley High School he entered the employ of the First National Bank, with which he has been associated for

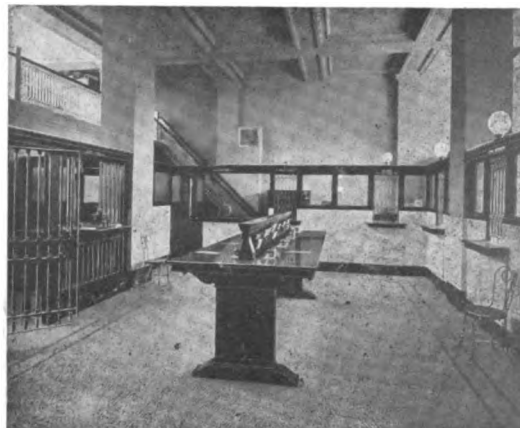

Savings Department, First National Bank, Berkeley, Cal.

the past thirteen years. Entering as messenger, he has served in all departments, and was elected assistant cashier in 1914.

Frank H. Thatcher is assistant cashier of the First National Bank. He was with the Alaska Banking and Safe Deposit Company of Nome, Alaska, for fifteen years and from 1908 to 1915 he was president and manager of that institution. He filled the position as cashier of Homestead Bank, Berkeley, from fall of 1915 to September, 1916, and was elected assistant cashier of First National Bank, Berkeley, at the time the Homestead Bank was purchased.

G. T. Douglas, manager of the Telegraph Avenue Branch, was born in 1884 at West Milton, Ohio. He left Earlham College in 1903 and became

associated with First National Bank, West Milton, which was established by his father and grandfather in 1882. In 1912 he came to First National Bank, Berkeley, as manager of the safe deposit department. The following are the significant dates in his career: Graduated from American Institute of Banking in 1912; collection teller, 1913; assistant cashier, 1914; manager Telegraph Avenue Branch, Berkeley Bank of Savings and Trust Company, 1915.

GROWTH IN DEPOSITS AND RESOURCES

The following table gives a comprehensive view of the remarkable growth of the First National Bank and the Bank of Savings and Trust Company since 1892:

STATEMENT OF DEPOSITS AND RESOURCES OF THE FIRST NATIONAL BANK, BERKELEY, CAL., AND THE BERKELEY BANK OF SAVINGS AND TRUST COMPANY

Jan. 1.	Deposits		Total Deposits	Combined Resources
	Deposits First National Bank	Berkeley Bank of Savings and Trust Company		
1892	\$45,000	\$3,000	\$48,000	\$100,000
1895	92,000	28,000	120,000	500,000
1900	240,000	277,000	517,000	1,025,000
1905	737,000	1,024,000	1,761,000	3,050,000
1910	1,992,000	2,502,000	4,494,000	5,500,000
1911	2,089,000	2,990,000	5,079,000	6,289,000
1912	2,061,000	3,335,000	5,396,000	6,750,000
1913	2,210,000	3,813,000	6,023,000	7,467,000
1914	2,563,000	4,230,000	6,793,000	8,322,000
1915	2,315,000	4,090,000	6,405,000	8,164,000
1916	2,502,000	5,106,000	7,608,000	9,506,000
1917	3,297,0	7,131,000	10,428,000	12,512,000



NOW, as of old, forethought and frugality are the safest and best guide for human well-being.—FRANK C. MORTIMER.

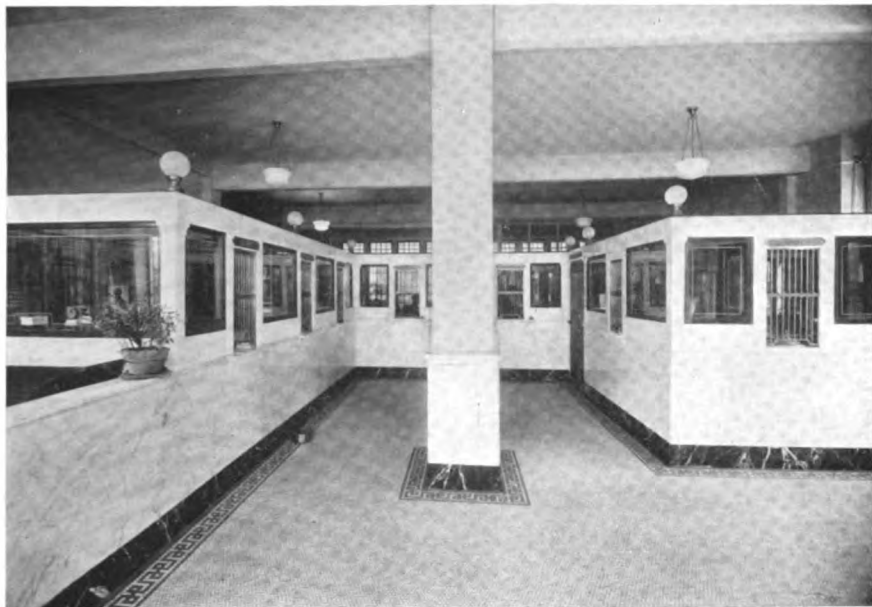

Main Banking Room, Central Bank and Trust Company, Asheville, N. C.

Central Bank and Trust Company, Asheville, N. C.

IN Asheville, N. C., the Central Bank and Trust Company is located in a recently modeled and enlarged banking room, which, for beauty and adequacy, ranks with the best in the South. The new fixtures are of Italian and Vermont marble, and all the woodwork and furniture are mahogany; the floors are tile, laid in artistic mosaic pattern. The lobby is spacious and admirably lighted and ventilated, in it there are four marble cheque desks.

On the right of the entrance is a commodious ladies' room, handsomely furnished in mahogany, with draperies and rug of green, and provided with a sufficient number of desks and chairs to accommodate the woman depositors. A private telephone booth adjoins this

room for the convenience of the ladies.

At the left of the lobby is a large private office for the officers, with ample space for officers and customers.

The directors' room is in the rear of the floor, insuring privacy and quiet. It is furnished in mahogany.

All cages are equipped in the most modern way and contain numerous appliances which are essential in expediting the work. The arrangement is such that a teller in his cage can transact every branch of the business without leaving it. There are seven bronze wickets fronting the lobby for receiving and paying tellers, collection, discount clerks, savings, bookkeepers, etc.

There are three vaults of heavy steel and concrete construction. They afford



Officers of the Central Bank and Trust Company, Asheville, N. C.
Left to right, Upper : W. B. McEWEN, J. R. OATES, Vice-Presidents
Centre : CHAS. W. BROWN, President
Lower : WALLACE B. DAVIS, Cashier ; RUSSELL C. DAVIS, Assistant Cashier



Central Bank and Trust Company, Asheville, N. C.

adequate protection against fire, and every known method practised by burglars.

At the rear of the main banking room is a massive bronze door which admits the patrons to the safety deposit vault; adjoining this are private coupon booths for their convenience.

Among the new equipment is the double-lug screw door safe, which weighs 15,000 pounds, and stands in

the money vault. This is made of Tisco manganese steel and has three time locks.

Beside the safe, there are compartments made of steel in the money vault for the storing of collaterals, note cases and bags of silver; also lockers for the tellers.

The book vault is furnished with metal shelves and filing cabinets.

One of the most interesting features



Directors of the Central Bank and Trust Company, Asheville, N. C.
Left to right, Upper : JOHN W. RUTHERFORD, J. D. EARLE, EUGENE CARLAND,
HON. CHAS. FRENCH TOMS
Centre : JUDGE HENRY B. STEVENS, JOHN A. NICHOLS
Lower : DR. JAS. A. SINCLAIR, CANIE N. BROWN, DR. PHILIP R. MOALE,
HON. THOMAS S. ROLLINS



Employees of the Central Bank and Trust Company, Asheville, N. C.
Left to right, Upper : SIDNEY UNDERHILL, S. C. PARKER, RUSSELL M. YAUNT
Centre : MISS ELLA CARTER
Lower : CARLYE WATKINS, H. J. WOODY, LEA RICHMOND

of the new quarters is the huge clock which hangs outside the door, and chimes beautifully every fifteen minutes.

HISTORY OF THE BANK

The history of the Central Bank and Trust Company is one in which the officers may well take just pride. Since its organization five years ago it has progressed steadily and rapidly to a position of commanding importance among the financial institutions of the city. Its progress is evidenced by the following figures, which show deposits for the years mentioned:

March 18, 1912	\$19,313.50
March 18, 1913	204,248.06
March 18, 1914	323,684.14
March 18, 1915	377,189.33
March 18, 1916	818,984.95
March 18, 1917	1,632,437.05

This successful record is due to the fact that those identified with the bank as officers and directors are men familiar with Asheville's business affairs and keenly interested in their development. They have had both the

judgment and foresight essential to the wise employment of banking funds, so as to afford the widest possible service consistent with safety.

The management of the bank has been in the hands of W. B. Davis, cashier, who was a leader in the organization of the institution. He is a man of energy, ability and wide popularity, and began his business life as a boy in a bank. His practical knowledge of the details of banking is reflected in the thorough system of records and accounting which he installed.

The statement of the bank at the close of business May 1 was as follows:

RESOURCES	
Loans	\$1,429,148.92
Furniture and fixtures....	15,000.00
Cash and due from banks..	313,743.66
	<hr/>
	\$1,757,892.58
LIABILITIES	
Capital	\$50,000.00
Surplus and profits.....	64,801.81
Bills payable
Rediscounts
Interest reserve	1,430.02
Deposits	1,641,660.75
	<hr/>
	\$1,757,892.58



THE practice of thrift deals not only with the present, but it affects very materially the social fabric of the future. It will affect in great measure the civilization and the moral fabric of the nation. It will assist those in moderate circumstances to mend their fortunes, and help to bring them to a realization of the dignity which springs from independence founded on the basis of a solvent estate.

—FRANK C. MORTIMER

Banking and Financial Notes

IRVING NATIONAL AND BROADWAY TRUST LINKED

It has been announced that the directors and largest stockholders of the Irving National Bank and the Broadway Trust Company, of New York City, representing sufficient stock holdings to make the plan effective, have definitely approved of a plan whereby the interests represented in these two



LEWIS E. PIERSON
Chairman of the Board Irving National Bank,
New York

institutions will hereafter be united in a joint stock ownership arrangement in which the present stockholders in each institution will hold stock in both, on a ratio based upon the relative capitalization of the two institutions. In order to provide a simple ratio the capital stock

of the Irving is to be increased from \$4,000,000 to \$4,500,000, the \$500,000 new Irving stock to be issued at \$150.

Such joint ownership of a national bank and a trust company is neither new nor untried, having for many years operated to the great advantage of joined institutions in Chicago and many other cities. The number of such joined institutions in this country exceeds 300. Some notable examples of joint ownership are: The First National Bank with the First Trust and Savings Bank; the Continental and Commercial National Bank and Commercial Trust and Savings Bank, both in Chicago, and the First National Bank with the First Trust and Savings Company of Cleve-



The Branch
Our first President

Merchants National Bank

RICHMOND, VA.

Capital \$400,000
Surplus and Profits over 1,000,000

The Gateway to and Collection
Center for Southeastern States

Send Us Your Items

"ON TO RICHMOND"

land. As worked out upon this plan, the situation will be as follows:

Each present stockholder of each institution will hold combined stock in the ratio of three of Irving to one of the Broadway. Combined capital and surplus will amount to \$11,340,000 and on the basis of the last published statements combined resources will be over \$156,000,000.

The purpose of this plan is to bring together the special fields and services of the national bank and the trust company in such a manner as to offer the combined facilities most advantageously to both customers and stockholders. In this way, it will be possible to secure the benefits of a broader scope of banking than is allowed to a national bank under the bank laws, and to provide ample and adequate facilities to meet all the banking requirements of the friends of both institutions.

For some time a number of the stockholders of the Irving also have held stock in the Broadway Trust Company. Under the new arrangements, in which all stockholders of both institutions can participate, the harmonizing of the interests represented will be carried out more fully and more nearly to a logical conclusion than at present.

Apart from the combination of stock indicated, both institutions will continue to operate separately and independently as far as administration and the interests of the public are concerned. The legal entities will remain as they are

at present. The Irving and the Broadway will continue their present charters unaltered, and the management of each will remain unchanged. The customers of the two institutions may rest assured that there is nothing in the



ROLLIN P. GRANT
President Irving National Bank, New York

plan indicated which will in any way disturb their convenience, or which will affect their interests in any but a most helpful manner.

In order to make the plan of combination effective the stock of both institutions is to be temporarily deposited with the Broadway Trust Company, which institution will act as agent for the committee representing the two institutions. Negotiable receipts will be delivered against the stock thus deposited.

After the exchange of stock has been effected and new certificates issued therefor, under the new ratio these new certificates will be deposited with the Central Trust Company of New York,

United States Corporation Company

65 CEDAR STREET
NEW YORK CITY

ACTS AS

Transfer Agent and Registrar

FURNISHES

Principal Offices for Corporations in all
States and the Canadian Provinces



The Chemical National Bank of New York

(Established 1824)

Capital, Surplus and Undivided Profits \$11,000,000

The First Bank on Broadway

IN 1824, when the Chemical National Bank first threw open its doors at 216 Broadway, opposite St. Paul's Church, financiers and others freely expressed the opinion that it was going too far uptown. Tradition, then as now, made Wall Street the center of finance.

In spite of this apparently radical departure, the Chemical National Bank at once established a reputation for conservative banking practice—a reputation which has placed it among the leading financial institutions of the country.

The officers of the bank will be glad to meet or correspond with those who contemplate opening new accounts or making a change in their banking relations. Interest paid on balances of banks, time deposits, and special and reserve accounts.

Joseph B. Martindale, President

H. K. Twitchell, Vice-President

E. H. Smith, Assistant Cashier

Francis Halpin, Cashier

I. B. Hopper, Assistant Cashier

James L. Parson, Assistant Cashier

J. G. Schmelzel, Assistant Cashier

DIRECTORS

Frederic W. Stevens

Charles Cheney

Ridley Watts

W. Emlen Roosevelt

Arthur Iselin

Joseph B. Martindale

Robert Walton Goelet

Frederic A. Julliard

Herbert K. Twitchell

as depository, which will issue therefor its deposit receipt in the name of the owner for the joint deposit of his Irving and Broadway stock. This deposit receipt covering the proper proportion of Irving and Broadway stock will be negotiable and may be bought and sold in place of the stock of both institutions which it represents.

The careers of these two institutions have been most interesting. Both started on a comparatively small scale and in simple surroundings, and both moved into the Woolworth building at the time of its opening. The Irving, a few years ago, with limited resources, occupied comparatively modest quarters on the West Side. Now, with a capital and surplus exceeding \$8,000,000—with resources which long ago have passed the \$100,000,000 mark, and with spheres of influence developed in commercial centers throughout the world, it has grown to be one of the largest of American commercial banks.

In 1907 it merged with the business

of the New York National Exchange Bank; in 1912 it took over the business of the Mercantile National Bank, and in 1914 took over the business of the National Nassau Bank. Lewis E. Pier-son is the active chairman of the Irving's board of directors. The president is Rollin P. Grant; the other directors are as follows:

F. A. M. Burrell Brooklyn, N. Y.; M. M. Belding, Jr., president Belding Bros. & Co., manufacturers sewing silks; William H. Barnard, treasurer International Salt Company; William C. Breed, of Breed, Abbott & Morgan, counsellors at law; William Childs, Jr., vice-president Childs Company; Warren Cruikshank, president Cruikshank Company; J. Amory Haskell, vice-president E. I. du Pont de Nemours & Co.; Harold A. Hatch, of Deering Milliken & Co., commission dry goods; Horace Havemeyer, president Havemeyer & Elder, Inc.; Lee Kohns, of L. Straus & Sons, pottery and glassware; Frederic G. Lee, president Broadway Trust Company; John G. Luke, president West Virginia Pulp and Paper Company; Sidney Z. Mitchell, president Electric Bond and Share Company; Daniel P. Morse, McElwain, Morse & Rogers, wholesale boots and shoes; Charles E. Perkins, president J. T. Perkins Company, yarns; John J. Pulleyn, president Emigrant Industrial Savings Bank; J. H. Schoonmaker, vice-president Butler Bros. Inc., wholesale general merchandise; William Skinner, of William Skinner & Sons, silks; John H. Seed, Brooklyn, N. Y.; S. Frederick Taylor, president Borden's Con-

condensed Milk Company; William A. Tilden, president Fort Dearborn National Bank, Chicago, Ill.; Gustav Vintschger, president Markt & Hammacher Co., import and export; Theodore F. Whitmarsh, vice-president F. H. Leggett & Co., wholesale grocers; Daniel W. Whitmore, of D. W. Whitmore & Co., wholesale dairy produce; Harry M. Williams, president the Union News Company; Frank W. Woolworth, president F. W. Woolworth Company, five and ten cent stores; Harry E. Ward, vice-president.

The history of the Broadway Trust Company is scarcely less interesting. It was located and had its origin at Broadway and Eighth street. In 1908, when some of the Irving stockholders became



FREDERIC G. LEE

President Broadway Trust Company, New York

interested in the Broadway's welfare, it merged with the business of the Flatbush Trust Company of Brooklyn, branches on Flatbush and Linden avenues, and New Utrecht branch on New Utrecht avenue, Brooklyn. It later took over the Aetna National Bank, occupying the old quarters of the Irving National Bank, at West Broadway and Chambers street, and still later, the Commercial National Bank of Long Island City, so that it now operates five branches, with its headquarters in

the Woolworth building. Its capital and surplus is \$2,430,000 with resources exceeding \$30,000,000. The president is Frederic G. Lee, who has been connected with the company since its organization and president since 1909. Its directors are:

M. M. Belding, vice-president; Eugene S. Benjamin, I. S. Wolf & Co.; William C. Breed, Breed, Abbott & Morgan; F. A. M. Burrell, Brooklyn, N. Y.; James Clarke, New York; Warren Cruikshank, president Cruikshank Company; William K. Dick, Brooklyn, N. Y.; John H. Flagler, New York; Emanuel Geril, E. Geril & Co.; Walter M. Gladding, vice-president Borden's Condensed Milk Company; Horace Havemeyer, president Havemeyer & Elder, Inc.; Frederic G. Lee, president; John H. Love, Graupner, Love & Lamprecht; Adam K. Luke, treasurer West Virginia Pulp & Paper Co.; George C. Meyer, Cord Meyer Development Company; Lewis E. Pierson, chairman Irving National Bank; John J. Pulleyn, president Emigrant Industrial Savings Bank; J. L. Reiss, president International Tailoring Company; Theo. F. Whitmarsh, vice-president Francis H. Leggett & Co.; Frank W. Woolworth, F. W. Woolworth Company.

LIBERTY NATIONAL BANK TO INCREASE CAPITAL

A stockholders' meeting of the Liberty National Bank of New York has been called for July 26 to vote that the bank's capital stock be increased from \$1,000,000 to \$3,000,000, and that \$1,000,000 be transferred from the undivided profits account to surplus. It is planned to grant present stockholders the privilege of subscribing at par to two shares of new stock for each share of their present holdings.

At the close of business, May 1, the condition of the Liberty National was as follows:

RESOURCES	
Loans and Discounts.....	\$49,221,074.00
U. S. Bonds to secure Circulation.....	500,000.00
U. S. Bonds on Hand.....	1,050,000.00
Bonds to secure U. S. Deposits.....	635,683.22
Bonds, Securities, Etc.....	10,323,338.86
Due from Banks.....	703,305.50
Exchanges for Clearing House....	6,448,443.85
Cash.....	13,667,739.12
	<hr/>
	\$82,549,584.55
LIABILITIES	
Capital Stock.....	\$1,000,000.00
Surplus Fund.....	2,000,000.00
Undivided Profits.....	1,856,158.41
Reserve for Taxes, Etc.....	99,095.86
Circulation.....	485,750.00
Deposits.....	76,982,352.44
Unearned Discount.....	126,227.84
	<hr/>
	\$82,549,584.55

The following is a list of the bank's officers:

MERCANTILE Trust & Deposit Co.

opened May 1st, at

115 BROADWAY NEW YORK

for the conduct of a

General Banking and Trust Business

Capital . . . \$1,000,000
Surplus . . . 500,000

CHELLIS A. AUSTIN *President*
CHARLES D. MAKEPEACE . . . *Vice-Pres. and Secretary*
CORNELIUS J. MURRAY *Asst. Treasurer*
JOHN A. BURNS *Asst. Secretary*

THIS institution will be glad to place its complete banking and trust company facilities at the service of banks, corporations, firms and individuals, whether located in New York or elsewhere.

THE company is equipped to handle Trust business in both its Individual and Corporate Trust departments.

AS the success of any banking institution rests fundamentally on the character of its Directorate, especial attention is called to the men under whose inspiration and guidance the Mercantile Trust & Deposit Company starts its business life.

DIRECTORS

Chellis A. Austin, President of the Company	Herbert P. Howell, Vice-President National Bank of Commerce
Elliott Averett, Vice-President United Cigar Stores Co.	N. D. Jay, Vice-President Guaranty Trust Co.
Edward J. Barber, Vice-President Barber & Co., Inc.	James W. Johnston, Treasurer Western Electric Co.
Henry S. Bowers, Goldman Sachs & Co., Bankers	Bertram Lord, Foreign Financial Manager, Wells Fargo & Co.
Frank N. B. Close, Vice-President Bankers Trust Co.	Elgood C. Lufkin, President The Texas Co.
Delos W. Cooke, Vice-President Erie Railroad	John McHugh, Vice-President Mechanics & Metals National Bank
C. G. Du Bois, Comptroller American Tel. & Tel. Co.	Theodore F. Merseles, Vice-President and General Manager National Cloak & Suit Co.
Frederick F. Fitzpatrick, President Railway Steel Spring Co.	Albert G. Milbank, Masten & Nichols, Lawyers
Harvey D. Gibson, President The Liberty National Bank	Samuel H. Miller, Vice-President Chase National Bank
William Giblin, President Mercantile Safe Deposit Co.	Sherburne Prescott, Treasurer Anglo-American Cotton Products Corp.
Thomas Hildt, Vice-President Bankers Trust Co.	Jackson E. Reynolds, General Attorney Central R. R. of N. J.
Alfred R. Horr, Treasurer Equitable Life Assurance Society	Charles S. Sargent, Jr., Kidder, Peabody & Co., Bankers

Kings County Trust Company

City of New York, Borough of Brooklyn

Capital \$500,000 Surplus \$2,000,000 Undivided Profits \$800,000

OFFICERS

JULIAN P. FAIRCHILD,
WILLIAM HARKNESS,
D. W. McWILLIAMS,
WILLIAM J. WASON, JR.,

JULIAN D. FAIRCHILD, *President*

Vice-Presidents

THOMAS BLAKE, *Secretary*
HOWARD D. JOOST, *Assistant Secretary*
J. NORMAN CARPENTER, *Trust Officer*
GEORGE V. BROWER, *Counsel*

ACCOUNTS INVITED.

INTEREST ALLOWED ON DEPOSITS.

Harvey D. Gibson, president; Daniel G. Reid, vice-president; Charles W. Riecks, vice-president and cashier; Alexander M. Hall, 2nd, Ernest Staufen, Jr., Joseph A. Bower, vice-presidents; Frederick P. McGlynn, Theodore C. Hovey, Louis W. Knowles, Frederick W. Walz, assistant cashiers.

A portrait of President Gibson appears as the frontispiece in this number of *THE BANKER'S MAGAZINE*.

NEW ADVERTISING MANAGER FOR NATIONAL BANK OF COMMERCE IN NEW YORK

The National Bank of Commerce in New York, recognizing the value of advertising as an element of banking growth, has appointed James I. Clarke to head its advertising department as manager. Mr. Clarke has been associated with the service department of the bank since the 21st of February, and his work has already attracted exceptional attention and much favorable comment.

Mr. Clarke comes to his new post with unusual equipment for its duties. He is a native of Saratoga Springs, N. Y., and very early in life gained literary training. While at Cornell University, from which he graduated with the degree of LL.B., in the Class of 1912, he was an associate editor of the Cornell "Daily Sun" and publisher of the Cornell "Era," a monthly literary magazine.

After leaving college he went with the Chalmers Motor Co. of Detroit, leaving there to join the editorial staff

of the New York "Sun," and was connected with that newspaper for four years in various capacities, including that of assistant night city editor. As



JAMES I. CLARKE

Manager Advertising Department National Bank of Commerce in New York

stated above, he joined the forces of the National Bank of Commerce in February last.

Mr. Clarke is a member of the Delta Chi (National, legal) Fraternity, and Cornell University Club of New York.

National Bank of Commerce in New York

PRESIDENT
JAMES S. ALEXANDER

VICE-PRESIDENTS
R. G. HUTCHINS, Jr.
HERBERT P. HOWELL
J. HOWARD ARDREY
STEVENSON E. WARD
JOHN E. ROVENSKY
GUY EMERSON

CASHIER
FARIS R. RUSSELL



ASSISTANT CASHIERS
A. J. OXENHAM
WILLIAM M. ST. JOHN
LOUIS A. KEIDEL
A. F. MAXWELL
JOHN J. KEENAN
GASTON L. GHEGAN
A. F. BRODERICK
EVERETT E. RISLEY
H. P. BARRAND

MANAGER FOREIGN DEPARTMENT
FRANZ MEYER

CAPITAL, SURPLUS AND UNDIVIDED PROFITS OVER \$45,000,000

ANNUAL CONVENTION NEW YORK STATE BANKERS' ASSOCIATION

At the twenty-fourth annual convention of the New York State Bankers' Association held at Lake Placid, N. Y., June 19 and 20, the following officers were elected: President, John H. Gregory, president Central Bank of Rochester; vice-president, Delmar Runkle, president Peoples National Bank, Hoosick Falls; treasurer, T. A. Reddish, cashier Owego National Bank, Owego; secretary, E. J. Gallien.

An unusually interesting program was carried out which included addresses by Benjamin E. Smythe, president of the association; Captain Arthur Hunt Chute; M. A. Traylor, president Live Stock Exchange National Bank of Chicago; Frank White, R. D. Chapin and Charles Moore. Speakers at the banquet comprised Thomas W. Lamont, G. M. Dahl and Dr. Willard Scott.

The feature of the convention was the adoption without a dissenting voice of a resolution pledging the association to contribute to the aid of the Red Cross Society the sum of approximately \$3,000,000.

OLDEST BANKER CELEBRATES 95TH BIRTHDAY

Elias Greenebaum, founder of Greenebaum Sons Bank and Trust Company, Chicago, celebrated his 95th birthday June 24. Mr. Greenebaum is believed to be the oldest active banker in the world. Although he has retired from the more trying duties of his business, he still makes daily visits to his office.

He continues the practice he acquired sixty-two years ago when he was the first one on the job. The daily hour

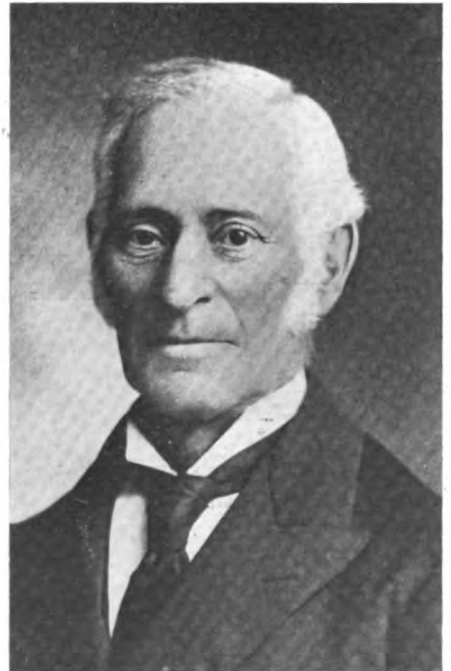

ELIAS GREENEBAUM
Founder Greenebaum Sons Bank and Trust Co.,
Chicago, Ill.

for his arrival is 8:15 a. m., and to this day he has not changed it.

The day prior to his birthday, which fell on Sunday, was the unofficial reception day at the bank. Congratulatory telegrams from every part of the United States were showered upon him

THE COMPTROLLER OF
THE CITY OF NEW YORK

will sell at his office in the Municipal Building, on
Thursday, July 12, 1917, at 2 P. M.

\$47,500,000---4½%

Gold Corporate Stock of the City of New York
Payable July 1, 1917,
and

\$7,500,000---4½%

Gold Corporate Stock (15-Year Serial) of the City of New York
Maturing annually from July 1, 1918, to July 1, 1932, inclusive.

EXEMPT FROM FEDERAL INCOME TAX

**and from all Taxation in the State of New York Except for
State Purposes.**

The latter class will be only sold in series. For example: A single bid for \$15,000 is a proposal for 15 \$1,000 items maturing from one to fifteen years. No bids will be accepted for separate maturities.

Separate Proposals must be made for each class.

The Greater New York Charter provides that bids may be made
for as small an amount as \$10 and in multiples of \$10 for each maturity.

**No bid for Corporate Stock in the serial form can be accepted for less
than \$150.**

Send bids for each class in separate sealed envelopes, enclosed in other envelopes addressed to the Comptroller. A deposit of Two Per Cent of Par Value must accompany each Bid. Such deposit must be in money or certified check upon a New York State Bank or Trust Company, or any National Bank.

For fuller information see "City Record," published at Nos. 96 and 98 Reads street, New York, or consult any Bank or Trust Company. Send for descriptive circular to

WILLIAM A. PRENDERGAST, Comptroller,
City of New York, Municipal Building, New York.

and the aged banker proved his youth by reading them without glasses. He was behind banks of flowers, donations from his relatives, friends and employees. From the hour of his arrival until the noon closing hour of the bank it was a continual handshaking bee, at the close of which Mr. Greenebaum declared it had been one of the happiest days of his life.

Mr. Greenebaum was born June 24, 1822, in Eppelsheim, Germany. He came to the United States seventy years ago, and started in the banking and real estate loan business eight years later. His family still treasures an advertisement carrying his business card published in the "Democratic Press" in 1855. The bank which grew out of this business is now being conducted by three generations of the family.

BOOKLET ON RESERVE ACT AMENDMENTS

The Federal Reserve Act amendments, approved June 21, which

strengthen the entire banking structure of the United States by allowing for the incorporation of state banks and trust companies into the Federal System, and materially affect banking at such important points as, the reserves of member banks, Federal Reserve note issues, and bank and trade acceptances, are presented in a pamphlet prepared by the National Bank of Commerce in New York for its clients. The book includes the amendments conveniently arranged and a complete text of the Federal Reserve Act in its present form.

**GUARANTY TRUST COMPANY INCREASES
CAPITAL**

At a special meeting of the stockholders of the Guaranty Trust Company of New York, held June 25, it was voted to increase the capital stock of the company from \$20,000,000 to \$25,000,000. The new stock will be offered to the stockholders of the company of rec-

An American Bank



for Foreign Trade

MERCANTILE BANK of the AMERICAS, Inc.

Incorporated 1915

Capital and Surplus, \$2,500,000

NEW YORK OFFICE: 88 Pine Street

PARIS OFFICE: 11 Boulevard Haussmann

DIRECTORS:

JAMES BROWN
THATCHER M. BROWN
JASON A. NEILSON

ALBERT STRAUSS
FREDERICK STRAUSS

CHARLES H. SABIN, President
MAX MAY, Vice-President
ALBERT BRETON, Vice-President

WILLIAM A. GASTON, President

HERBERT FLEISHHACKER,
President

ADOLFO STAHL

BROWN BROTHERS & CO.
New York, Philadelphia, Boston

J. & W. SELIGMAN & CO.
New York

GUARANTY TRUST COMPANY
OF NEW YORK

NATIONAL SHAWMUT BANK
OF BOSTON

ANGLO & LONDON PARIS
NATIONAL BANK
San Francisco
New York

ALFRED MEYER, General Manager

The Mercantile Bank of the Americas, Inc.

transacts business for

Bankers

Merchants

Manufacturers

As an Intermediary Bank

As a Representative or Agent

It collects drafts; effects payments of money by cable or mail; issues letters of credit; finances exports and imports; obtains credit information for its clients; purchases and advances against bills drawn on South and Central America wherever it is represented.

For its clients it effects sales and purchases of merchandise; introduces and recommends travelling representatives; acts as resident representative to receive orders or recommends active local agents to sell under its supervision; arranges storage abroad for American goods pending delivery.

The Mercantile Bank of the Americas, Inc.

offers a complete and direct

Merchant Banking Service

to the American Banker and Business House desirous of extending business in South and Central America. This Institution maintains its own local subsidiary banks, agencies or affiliated institutions in:

PERU

ECUADOR

COLOMBIA

VENEZUELA

COSTA RICA

NICARAGUA

SALVADOR

GUATEMALA

HONDURAS

and other countries in

SOUTH and CENTRAL AMERICA



100 YEARS OF COMMERCIAL BANKING

LOUIS G. KAUFMAN
President

FRANK J. HEANEY
Vice-President

WILLIAM H. STRAWN
Vice-President

NORBORNE P. GATLING
Vice-President

H. A. CLINKUNBROOMER
Vice-President

ROLFE E. BOLLING
Vice-President

HENRY L. CADMUS
Asst. Cashier

HENRY C. HOOLIER
Asst. Cashier

RICHARD H. HIGGINS
Vice-President

BERT L. HASKINS
Vice-Pres. and Cashier

C. STANLEY MITCHELL
Vice-President

MAX MARKELL
Vice-President

GEORGE R. BAKER
Vice-President

WALTER B. BOICE
Asst. Cashier

VINTON M. NORRIS
Asst. Cashier

JOSEPH BROWN
Asst. Cashier

GEORGE M. HARD
Chairman

ACCOUNTS INVITED

Resources **Ninety-six Million Dollars**

ord at the close of business June 25 for subscription and payment ratably in the proportion of their respective holdings, at the rate of twenty-five per cent. thereof, at 'par on or before July 16.

The capital stock of the Guaranty Trust Company was increased from \$10,000,000 to \$20,000,000 in November, 1915. The company was founded in 1864 under the name of the New York Guaranty and Indemnity Company. In 1891, the capital was increased from \$100,000 to \$2,000,000 with a paid-in surplus of \$500,000. In 1893 the present title of Guaranty Trust Company of New York was adopted. The capital was increased to \$5,000,000 in 1910, and to \$10,000,000 in 1912.

The latest statement of the company. February 28, 1917, shows, in addition to its capital of \$20,000,000, a surplus of \$20,000,000, undivided profits, \$5,817,781.98, and total resources of \$588,478,286.41. The company's resources in 1913, when Charles H. Sabin became president, were \$234,689,804.

ANALYSIS OF FEDERAL RESERVE ACT AMENDMENTS

The Mechanics and Metals National Bank of New York has prepared a booklet analyzing the amendments to

the Federal Reserve Act, which, after a year's consideration, have passed both houses of Congress and have been approved by President Wilson. The amendments have revised nine of the twenty-five sections of the Act, and are expected to have far-reaching effect on the nation's banking system. They are designed to facilitate the concentration of gold reserves in the Federal Reserve Banks, and at the same time attract into the system a large number of state banks and trust companies which heretofore have declined to become members.

The booklet of the Mechanics and Metals National Bank analyzes the amendments briefly and clearly.

AMENDMENTS TO FEDERAL RESERVE ACT

A synopsis of the numerous and important changes made in the Federal Reserve Act by the amendments which were approved by the President June 21, and which went into effect immediately, is given in a booklet just issued by the Guaranty Trust Company of New York. A digest of the law and the full text of the new amendments are also included. The changes in the law affect, among other things, the issue of Federal Reserve notes, the reserves of member banks, and the admission of

In New York

the Citizens National Bank is commonly known as the Bank for Merchants who require a highly specialized service.

In the care of out-of-town bank accounts the Citizens National Bank has developed a service which is characterized by the same spirit of thoroughness and special effort.

THE CITIZENS NATIONAL BANK OF NEW YORK

Capital, Surplus and Undivided Profits \$5,000,000

EDWIN S. SCHENCK, President

FRANCIS M. BACON, JR., Vice-Pres.

ALBION K. CHAPMAN, Cashier

JESSE M. SMITH, Asst. Cashier

GARRARD COMLY, Vice-Pres.

JAMES MCALLISTER, Asst. Cashier

WILLIAM M. HAINES, Asst. Cashier

state banks and trust companies to the Federal Reserve System.

CREDIT MEN PROVIDE AMBULANCES

The National Association of Credit Men, at its annual convention held at Kansas City last month, voted to place two field ambulances on the front in France as memorials to two of its deceased presidents who served in the earliest days of the association—James Graham Cannon of New York, the second president, and John Field of Philadelphia, the third president.

A sum was also appropriated sufficient to man the ambulances for a period of six months and the association hopes to be able to name the men who will take charge of these ambulances.

The association has chosen well in the form of memorial selected. To have connected their presidents who by hard work laid the foundations of this great national organization with the miniside of the great war in which the na-

tion they served is engaged, is a beautiful tribute that may well be imitated by other associations.

NEW MANAGER OF NEW YORK CLEARING-HOUSE

After serving for twenty-five years as manager of the New York Clearing-House Association and for four years as assistant manager, William Sherer has retired from the former position. Mr. Sherer is vice-president of the Metropolitan Savings Bank and is prominent in Masonic circles. Prior to entering the service of the clearing-house he was acting assistant treasurer and cashier of the New York Sub-Treasury.

The estimation in which he is held by the banks of the city was thus voiced by Alexander Gilbert, president of the Market and Fulton National Bank, and former president of the association:

"Mr. Sherer has been our manager for twenty-five years, and he was our assistant manager for a number of years

prior to that, and we all know that he has been very faithful. I know that I voice the sentiment of every member here when I express regret that circumstances make it necessary for him to retire. I have known Mr. Sherer perhaps longer than any other member of the association. He and I have traveled many years together along the roads of our past financial history. He occupied other positions of trust before we made him our manager, and it



WILLIAM SHERER
Retiring Manager New York Clearing House

is with great pleasure that I can testify that every trust that has been imposed upon him has been discharged with fidelity, and that is a great thing to say of any man. I am sure we all have in our hearts a desire and definite wish that the remaining years which he will spend in his retirement may be years of pleasantness and of comfort, and that they may bring to him a good deal of happiness."

William Jay Gilpin, assistant manager since 1892, has been elected man-



WM. JAY GILPIN
New Manager New York Clearing House

ager and Clarence E. Bacon, assistant manager.

PROMOTIONS IN SEABOARD NATIONAL BANK

The Seaboard National Bank, New York, announced last month the elec-



H. W. DONOVAN
Cashier Seaboard National Bank, New York

DJÖRUP, EDWARDS & McARDLE

Bank, Commercial, and Foreign
Exchange Audits and Systems

42 BROADWAY

NEW YORK

tion of W. K. Cleverley and L. N. De Vausney as vice-presidents and H. W. Donovan as cashier. Mr. Cleverley was

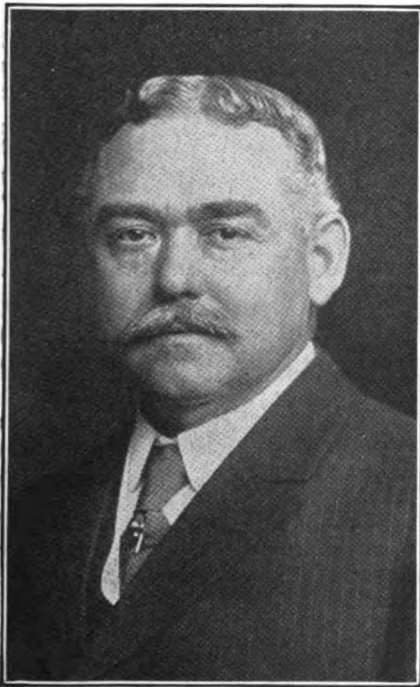

W. K. CLEVERLEY

Vice-President Seaboard National Bank, New York

formerly cashier while Mr. De Vausney and Mr. Donovan were assistant cashiers.

Mr. Cleverley began his banking career in the employ of the Importers and Traders National Bank where he remained only a short time. He became connected with the Seaboard National

Bank shortly after its organization in July, 1888, and served in various clerical capacities until made chief clerk and subsequently assistant cashier. In July, 1913, he succeeded C. C. Thompson as cashier and has held that office until his present election to a vice-presidency.



L. N. De VAUSNEY

Vice-President Seaboard National Bank, New York

Mr. DeVausney entered the employ of the Seaboard National as a messenger in September, 1897. He has served

in various departments and was for a number of years loan clerk, until June, 1907, when he was made assistant cashier, which position he has held until his election to a vice-presidency.

Mr. Donovan began his banking career with the First National Bank of Little Falls, Minn. After several years he resigned to become assistant secretary of the Northwest Colonization Company at St. Paul. In 1903 he became connected with the Bankers Trust Company, where he served in various positions, including that of assistant treasurer, treasurer and manager of the real estate department until January of this year, when he was appointed assistant cashier of the Seaboard National.

**G. FOSTER SMITH NEW HEAD OF THE
NASSAU NATIONAL BANK**

The directors of the Nassau National Bank of Brooklyn have elected G. Foster Smith president of that institution to succeed D. V. B. Hegeman, who declined re-election and has retired on account of illness.

Mr. Smith is a native of Michigan. He was for a time a student at Michigan University, and later graduated at the University of Minnesota, supplementing his university studies by a course at the New York Law School. He lived for a time in the South. His connection with the Nassau National Bank of Brooklyn began seventeen years ago, when he became assistant note teller, then note teller, assistant cashier in 1906 and cashier in 1911, earning each promotion by the most scrupulous attention to duty and by the display of exceptional ability as a banker. He has been vice-president and virtually the head of the bank for some time.

Mr. Hegeman, who retires, was born in Brooklyn in 1869 and educated at the Polytechnic Institute, Brooklyn. He began work in the Nassau National Bank at the age of sixteen as a runner and was successively promoted through every department; was made assistant cashier in 1897, cashier in



G. FOSTER SMITH
President Nassau National Bank of Brooklyn,
Brooklyn, N. Y.

1906, vice-president in 1911, and president, January 1, 1914.

ISSUES NEW BOOKLET

The Mechanics and Metals National Bank of New York have issued a booklet entitled "Applying Our Wealth to War." In a concise but most interesting manner the resources of the United States are set forth, special emphasis being laid upon those resources which will accomplish the greatest results in the world conflict.

"In applying our wealth to the war," says the booklet, "the rarest skill will be necessary. All departures in trade and finance must come in competition with the old order of things, and every effort will be made to bring about the transformation as smoothly as circumstances will permit. As a matter of fact, it is our American adaptability,

inventiveness and organization that will occupy a large part in the task to which we have addressed ourselves."

The annual income of the American people is placed by the bank at forty billion dollars; the annual savings at five billion. The booklet was designed with the purpose of stimulating subscriptions to the Liberty Loan.

APPOINTMENTS FOR PARIS BRANCH

Appointments have been made to fill the offices of the new Paris branch of the Guaranty Trust Company of New York, opening this month. A. Phillips has been chosen as manager of the office; G. Hebmann, sub-manager; W. G. Wendell, secretary, and R. P. Staigg, assistant secretary.

WINS ADDING MACHINE CONTEST

C. M. O'Grady, of the National Bank of Commerce of New York City, was recently presented with a cup by the American Institute of Banking for winning the contest for speed and accuracy on the adding-machine. Having won the contest for the third time, he obtained entire possession of the cup.

AMERICAN INSTITUTE OF BANKING HAS NEW OFFICERS

The New York Chapter of the American Institute of Banking has elected the following officers:

A. F. Maxwell, president; B. S. Miller, first vice-president; I. H. Meehan, second vice-president; L. H. Ohlrogge, treasurer; F. M. Totton, chief counsel, and C. M. Mead, librarian.

NEW YORK BANKER CALLED TO COLORS

G. M. P. Murphy, vice-president of the Guaranty Trust Company of New York, has received an appointment as major in the infantry section of the Officers' Reserve Corps, and his field of activity will be abroad. Mr. Murphy graduated from West Point.

CELEBRATES SEMI-CENTENNIAL

The Staten Island Savings Bank in the Borough of Richmond, New York, is celebrating its semi-centennial and in honor of the occasion has issued a very



TRADE MARK

During these days of feverish industrial activity, business enterprises financed by banks require, more than ever, the steady influence of Scientific Business Analysis.

Write for full particulars of our counselor service, explaining how we can serve banks by furnishing controlling information to their clients.

The G. K. Parsons Corp.

Engineers

Equitable Building New York

interesting booklet. The booklet gives a complete history of the bank, its various officers and trustees. The bank opened for business June 8, 1867, with an initial deposit of \$100, while to-day the total resources are over \$6,224,876.61.

125TH STREET BRANCH OF THE UNITED STATES MORTGAGE AND TRUST COMPANY CELEBRATES ITS TENTH ANNIVERSARY

The United States Mortgage and Trust Company of New York has issued a souvenir, marking the tenth anniversary of the opening of its 125th street branch. This branch, serving one of the busiest sections of Manhattan, was established by the United States Mortgage and Trust Company in order to meet the increased demands for banking and trust company service in that quarter. The 125th street branch is in charge of Mr. George A. Jones, manager, and Mr. Charles Diehl, assistant

manager. The company's resources, including all four branches, are now in excess of \$100,000,000.

BANK OF COMMERCE ISSUES NEW BOOKLET

The National Bank of Commerce in New York has published for its clients the selective draft law and the president's registration proclamation which affect directly and immediately ten million young men and concern in a vital way the entire nation. The complete text of the law and the proclamation is given in the hope that it may supply a definite need for accurate information on a matter which has an intimate bearing on the banking business as well as every other.

TWO NEW MEN IN NATIONAL BANK OF COMMERCE

A. F. Johnson, formerly a state bank examiner, and B. S. Miller, first vice-president of the New York Chapter of

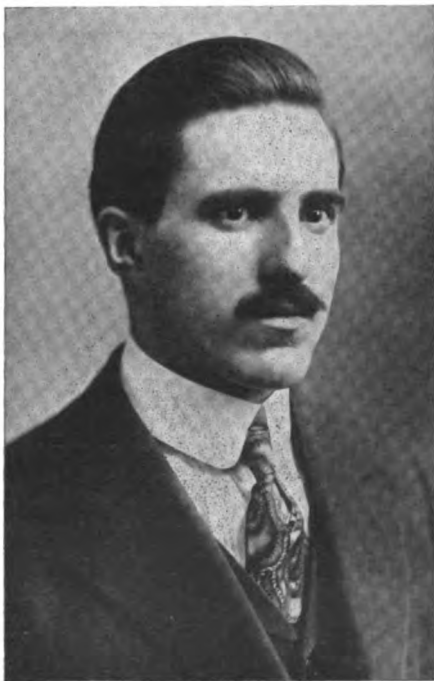

B. S. MILLER
National Bank of Commerce in New York

the American Institute of Banking, have recently become associated with the National Bank of Commerce of New York. Mr. Johnson was connected with the



A. F. JOHNSON
National Bank of Commerce in New York

Irving National Bank for a number of years, and Mr. Miller was with the Chemical National Bank for about fifteen years. Both men are well known in the financial world.

JOINS BOND DEPARTMENT OF GUARANTY TRUST

James Rattray, who has been with the Bank of Buffalo, Buffalo, N. Y., for nine years, more recently manager of the safe deposit vault and bond department, has become associated with the bond department of the Guaranty Trust Company of New York. Mr. Rattray has been active in the work of the Buffalo chapter of the A. I. B. for nine years, and has held every important office in the chapter, including that

A Better Service

In these days of highly developed banking methods, we know that we can only make headway by providing a service which is a little bit better than the other fellow's.

Atlantic National Bank

257 Broadway, New York

Capital, Surplus and Undivided Profits, \$1,800,000

of president. He is an Institute graduate and for three seasons acted as instructor of the banking and finance class of the Buffalo chapter, also as leader of its forum. These qualifications caused Mr. Rattray to be elected a member of the executive council of the American Institute of Banking in 1916.

ESSAY COMPETITION ON THRIFT

More than 400,000 American school children have completed essays on the subject of "Thrift," in competition for cash prizes given by the American Society for Thrift of New York. Of these 300,000 were contributed by children of the elementary grades in the schools of Greater New York where the contest was held under the supervision of the Board of Education. In the country the contest was supervised by the National Education Association. In addition to \$2,000 in cash prizes, 1,000 medals were presented to the youthful writers.

MAKES GOOD SHOWING FOR LIBERTY LOAN

In the great last minute drive for subscriptions to the Liberty Loan, the officials of the American Steel Export Company of New York were not satisfied with the showing already made by subscriptions totalling over \$75,000, but were desirous of registering as a participant everyone in the company. The vital need for making the loan a real and complete success, and especially for having every man and woman do their part, was pointed out, and within an hour after the ringing of the Liberty Bell in Philadelphia had set loose the wave of sound that swept the country, the last of the eighty employees had signed up.

COMMERCE CLUB HOLDS LIBERTY LOAN MEETING

The Commerce Club of the National Bank of Commerce in New York is striving to make the large number of liberty loan bond holders unanimous

within its membership devoted the final meeting of the season on June 12 exclusively to a patriotic demonstration for promoting subscriptions to the war bond issue under the bank's special arrangements for partial payments.

The speakers were R. W. Saunders, Adolph Johnson, Ira W. Aldom and C. J. Haulenbeck.

NATIONAL BANK OF COMMERCE SENDS
MISSION TO RUSSIA

A commission representing the National Bank of Commerce in New York has left New York for Russia. This mission is a constructive step towards cementing definite commercial relations



R. G. HUTCHINS, Jr.
Vice-President National Bank of Commerce in
New York

between Russia and the United States, and goes at the specific suggestion of several correspondents of the bank in Russia. The commission will be headed by R. G. Hutchins, Jr., senior vice-president of the National Bank of Commerce. Mr. Hutchins has always been

a pioneer in extending the frontiers of American business abroad. As vice-president of the Jeffrey Manufacturing Company, builders of coal mining machinery, he established foreign agencies



H. P. BARRAND
Assistant Cashier National Bank of Commerce in
New York

in New Zealand, Australia, South Africa, Russia, China and Japan. Mr. Hutchins was a director of the National Bank of Commerce in Columbus, Ohio, and president of the Columbus Chamber of Commerce. He is a director in the Allis-Chalmers Manufacturing Company and J. G. White Management Corporation.

He will be accompanied by H. P. Barrand, an assistant cashier from the bank's foreign department, and several assistants. Mr. Barrand, who is one of the young officers of the National Bank of Commerce, has had a wide experience in handling foreign business.

The National Bank of Commerce in New York, one of the leading commercial banking institutions of the world, will endeavor to establish actual com-

mercial connections with the largest banking firms and business houses in Russia, supplementing those which have been established during recent years.

The party sailed from Vancouver early in June. They will spend some time in Japan and go from there to Russia, where they will remain from two to three months. Prior to their return trip they will spend considerable time in Scandinavian countries.

FRANCIS H. SISSON WITH GUARANTY TRUST COMPANY

The Guaranty Trust Company of New York has appointed Francis H. Sisson vice-president in charge of publicity.



FRANCIS H. SISSON
Vice-President Guaranty Trust Company
of New York

Mr. Sisson has been prominent in railroad circles as assistant chairman of the railway executives' advisory committee, of which Mr. Frank Trumbull, chairman of the Chesapeake & Ohio Railway Company, is the head. Previous to that time Mr. Sisson was vice-president and general manager of the H. E. Lesan Advertising Agency of New York and Chicago, and has had a wide experience in the publishing and advertising field.

"Emergency Money"

Have often the embarrassment of being without ready cash has confronted you? And yet you wisely fear the risk of carrying a large sum in coin or currency.

The constant habit of keeping on your person a reserve fund in "A.B.A." Cheques means constant preparedness for emergencies requiring ready money.

"A.B.A." American Bankers Association Cheques

are accepted in all civilized countries as readily as actual money.

They are safe to carry, because no one can use them until you have countersigned them. Your counter-signature on an "A.B.A." Cheque, in the presence of the person accepting the Cheque, is the only identification required. They are the safest, handiest "travel money" as well as "emergency money."

Get them at your bank, or write Bankers Trust Company, New York, for booklet and information on all where they may be had in your country.

An advertisement
prepared by
EDWIN BIRD WILSON, Inc.
Financial Advertising
Bankers Trust Building
NEW YORK

He was formerly editor and publisher of daily newspapers at Peoria and Galesburg, Ill., and has been interested in various magazine and advertising activities since coming to New York, about twelve years ago.

Mr. Sisson was born in Galesburg, Ill., and is a graduate of Knox College in that city. He is also a graduate of Harvard, where he did post-graduate work.

He is president of the Beta Theta Pi college fraternity, and a member of various local clubs, including the Harvard, City, Advertising, Railroad and Economic clubs; and the Sleepy Hollow, Ardsley and Dunwoodie country clubs; also the University Club of Washington, D. C. He has served as president of both the Dunwoodie Country Club and the Beta Theta Pi Club.

In his editorial and advertising ex-

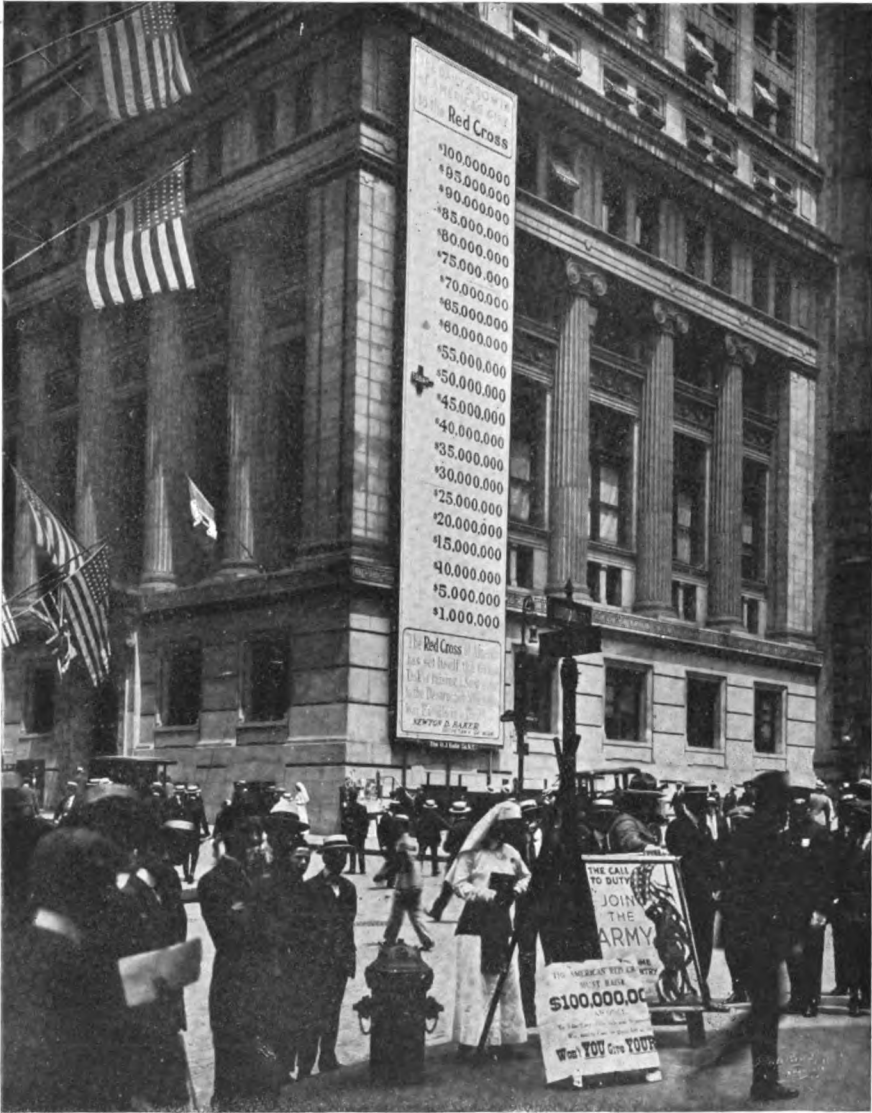

Red Cross Thermometer on the Bankers Trust Company building in New York. This photograph was taken June 22. By the end of the campaign the indicator had been forced up above the hundred million mark

perience he has written and spoken extensively on business and financial topics.

BINGHAMTON BANK'S FIFTIETH ANNIVERSARY

Commemorating its fiftieth anniversary the Binghamton Savings Bank of

Binghamton, New York, has issued a booklet showing the growth of the bank since its opening for business May 15, 1867, up to the present time. The bank now has a surplus of \$639,165.28 and deposits amount to \$7,622,561.59. The officers of the bank are: C. W. Gennet, president; J. G. Orton and C. M. Stone,

For information pertaining to Buffalo or its industries,
also the collection of items drawn on
this vicinity, write us.

Citizens Commercial Trust Company

Buffalo, N. Y.

Capital and Surplus, \$2,500,000

vice-presidents; A. C. Deyo, treasurer;
S. J. Hirschmann, secretary. A table
showing the increase in deposits for the
last fifty years is given below:

January 1, 1868.....	\$130,386.45
January 1, 1872.....	412,860.33
January 1, 1877.....	535,658.95
January 1, 1882.....	873,503.33
January 1, 1887.....	909,421.86
January 1, 1892.....	1,336,318.05
January 1, 1897.....	1,567,139.06
January 1, 1902.....	2,961,980.40
January 1, 1907.....	4,847,410.43
January 1, 1912.....	6,727,720.41
January 1, 1917.....	7,622,561.59

**NEW APPOINTMENT FOR PHILADELPHIA
BANK**

W. B. Ward has recently been elect-
ed assistant cashier of the Penn Na-
tional Bank of Philadelphia.

**THE FIRST NATIONAL ON THE LIBERTY
LOAN**

The June financial letter of the First
National Bank of Philadelphia deals
entirely with the liberty loan. Among
other things the bank states that flota-
tion of this loan has been of incalculable
service in bringing home to the Ameri-
can people that war, as conducted to-
day, is the most complicated business
undertaking that the world has ever en-
gaged in. It has made the population
think more of the cultivation of wheat
than the growing of orchids which a
year ago was the pastime of many rich
men. These same patriotic rich men have
gone from town to town making the
people realize that lending \$2,000,000,-
000 to the strongest government in the

world at 3½ per cent. is better than
paying an indemnity to Germany under
conditions named by the Kaiser.

PROPOSED INCREASE OF CAPITAL

The stockholders of the Franklin
Trust Co. of Philadelphia will hold a
special meeting on July 17 to discuss
the proposition of increasing the capi-



JOHN P. LAIRD
Recently Appointed Assistant Cashier Atlantic
National Bank, New York

HYDRO-CRETE

TRADE MARK

A NEW CONCRETE FOR BANK VAULTS

PRACTICALLY

FIRE, WATER AND BURGLAR PROOF

VAULTS INSTALLED AND UNDER CONTRACT

Federal Reserve Bank	- - - -	New York City
Guaranty Trust Company	- - - -	"
Metropolitan Life Insurance Company	- - - -	"
Sixty Liberty Street Corporation	- - - -	"
Rhode Island Hospital Trust Company	- - - -	Providence, R. I.

BY THE

HYDROLITHIC WATERPROOFING CO., Inc.

1328 Broadway

NEW YORK CITY

tal of the company from \$400,000 to \$600,000.

SURPLUS AND NET PROFITS OF UNION NATIONAL BANK

In an item which appeared in the June issue of THE BANKERS MAGAZINE the figures for the surplus and net profits of the Union National Bank of Philadelphia were incorrectly given as \$400,000. On May 1 this figure correctly stood at \$555,000 and the surplus alone is now \$450,000.

FINANCIAL LETTER OF THE FRANKLIN NATIONAL BANK

The June digest of trade conditions issued by the Franklin National Bank of Philadelphia contains helpful statistics along practically all business and financial lines. Referring to the cotton business the bank reports that domestic consumption of cotton in April totaled 552 thousand bales compared with 532 thousand bales in April a year ago. Stocks of cotton in consuming establish-

ments on April 30 totaled 2,032 thousand bales compared with 2,007 thousand bales on April 30, 1916, and stocks in public storage and at compresses were 2,504 thousand bales compared with 2,814 thousand last year. There were 33,260 thousand cotton spindles in operation during April compared with 32,113 thousand active in April, 1916. The final report on cottonseed shows that 4,331 thousand tons of cottonseed were received at the mills between August 1, 1916, and March 31, 1917, and of this amount 3,863 thousand tons were crushed compared with 4,132 thousand tons crushed from the 1915 crop. Crude cottonseed oil produced in the period totaled 1,187 million pounds, of which 144 million pounds were on hand on March 31 compared with seven million pounds on hand on August 1 last year. Refined cottonseed oil produced in the period mentioned totaled 955 million pounds and the amount on hand on March 31 was 321 million pounds compared with 222 million pounds on hand on August 1, 1916.

PHILADELPHIA BANK ANALYZES WAR
CONDITIONS

The last issue of the "Advance," which is the monthly publication of the Corn Exchange National Bank of Philadelphia, contains a highly interesting article answering the question, "will business continue as usual?" After thoroughly analyzing war conditions in Great Britain and Canada the bank states that it is fairly indicated by the experience of Great Britain that the exigencies of war force a certain readjustment in industry. Enlistments, labor and food shortage made it necessary to draw a sharp dividing line between essential and non-essential industries. But natural conditions there are harder to cope with. There is nothing in the experience of England which would indicate that there will be any serious readjustment in most lines of business in the United States because of our position as a belligerent.

Inflation is going on all over the world. As the "Monetary Times" of Canada says: "If the laboring man's wage is raised from two to four dollars per day, and the things which he has to buy are also doubled in price, he profits nothing from the wage increase. The value of labor and commodities is relative. The value of property is determined by the income it produces or the amount of money for which it can be exchanged and, carried further, by the quantity of things desired which such income or sale money will buy. The marking up of prices, the same ratio being maintained, is simply inflation and of no general advantage."

PITTSBURGH BANK REPORTS LOCAL
CONDITIONS

That there is no appreciable change in trade conditions in the Pittsburgh district is reported in the June business letter of the Peoples National Bank of Pittsburgh. The letter states:

"It is estimated that the steel industry is operating to about ninety per cent of maximum capacity. Orders on hand and the urgency of demand would justi-

Resources
\$15,000,000.00

If intelligent handling of items and low rates appeal to you send us your Buffalo business



Try our Service
and you will be entirely satisfied

A. D. BISSELL, President
C. R. HUNTLEY, Vice-Pres.
E. H. HUTCHINSON, Vice-Pres.
E. J. NEWELL, Vice-Pres.
HOWARD BISSELL, Cashier
C. G. FEIL, Asst. Cashier
A. J. ALLARD, Asst. Cashier
G. H. BANGERT, Asst. Cashier



EQUIPPED FOR SERVICE

Located in a modern building with every facility for the efficient handling of its business, this bank is in a position to offer you prompt and adequate service in your Philadelphia banking transactions.

**UNION
NATIONAL
BANK**



PHILADELPHIA
Resources over
\$13,000,000

fy one hundred per cent. operations if adequate labor and shipping facilities were available.

"A fair increase in coal production is to be noted, but it is below the average of pre-war times. The fuel problem appears to be as serious as the food problem, but we doubt not that the solution will be found if the situation becomes actually critical. This solution may take the direction of Government regulation which will concentrate mining operations in those districts most favored by nature and by man for the production and distribution of fuel. The Federal Trade Commission has already suggested the adoption of policies which in its judgment will bring relief to the fuel situation, although in the experience of operators adequate relief can come only through additional shipping facilities and an increase in the per capita output of the miners now available in the industry.

"In some other lines of trade a slight contraction is reported. This is most noticeable in building operations, some

rather important plans having been deferred, although demand, particularly for dwelling houses, has absorbed existing supply and rents have advanced sharply. Cost of material has had some weight, but the paramount factors have been uncertainty of delivery of structural materials and shortage in labor."

NEW MEMBER FOR RESERVE SYSTEM

The International Trust Co. of Boston has recently become a member of the Federal Reserve System, being the third Boston trust company to join.

RICHMOND BANK CLEARINGS

Showing the natural and steady growth of clearings in the Richmond, Virginia, banks, it is reported that for the first three weeks in June, 1917, the clearings exceeded those of the corresponding period last year \$28,107,713, while the clearings for this period last year exceeded the corresponding period in 1915 by \$25,054,420, the increase for the 1917 period over that of last

year being only \$3,053,293 greater than the increase of 1916 over 1915.

The clearings for the first three weeks in June amounted to \$88,405,918 for the corresponding period last year \$60,298,205, and for the first three weeks in June, 1915, \$35,243,785.

The above figures do not include the clearings of the Richmond County Clearing Association.

Bankers of Richmond are highly pleased at the excellent showing made by the clearing house and in the weekly reports of clearings of leading cities. Richmond is usually at the top of the list and often leads all the cities in the country on the percentage of increases.

**BRANCH OF RICHMOND RESERVE BANK
FOR BALTIMORE**

Formal announcement has been made by Governor George J. Seay of the Federal Reserve Bank of Richmond, Va., that the board of directors has determined to establish a branch of the bank in Baltimore and that the Federal Reserve Board approved of the plan. Agreement to establish the Baltimore branch was reached by the directors several weeks ago.

Governor Seay says the details of the establishment of the new branch bank will be worked out in the near future and just as soon as possible the bank will be established.

**NEW MANAGER RICHMOND COUNTY
CLEARING ASSOCIATION**

G. C. McWherter, of Macon, Ga., recently appointed manager of the Richmond County Clearing Association to succeed H. G. Proctor, has assumed his new duties and has been given a cordial welcome to the financial circles of the city. Mr. Proctor has been appointed cashier of the Union Savings Bank and Trust Company of Huntington, W. Va.

**NEW PRESIDENT VIRGINIA BANKERS
ASSOCIATION**

W. Meade Addison, vice-president of the First National Bank of Richmond,

**The Melting-Pot
America**

Into this great country have poured the peoples of the world—seeking opportunity and freedom. Inspired, uplifted, fused into a mighty citizenry of free-men, we have thrown our stupendous weight of men and money into the world scales on liberty's side.

The best effort of each is demanded. There must be no standing back. For the banker exists a wonderful opportunity. His influence should be positive, educational, confidence-inspiring. For his guidance, carefully perfected plans are available. For particulars write

COLLINS PUBLICITY SERVICE
Philadelphia, Pa.

was elected president of the Virginia Bankers Association at the annual meeting held at Old Point Comfort June 20. Mr. Addison is one of the most popular bank officials in the city and has been warmly congratulated on the honor conferred upon him.

RICHMOND'S RED CROSS CAMPAIGN

Richmond bankers took a conspicuous part in the Red Cross campaign conducted in this city and officers from every bank here gave a part of their time in the work campaign week, June 17-23. John Kerr Branch, president of the Merchants National Bank, was chairman of the Red Cross finance committee and was the largest individual subscriber to the fund, giving \$45,000. The city raised a total of about \$450,000, and enrolled a membership in excess of 20,000.

The National Shawmut Bank of Boston

President
WILLIAM A. GASTON

Vice-Presidents
HAROLD MURDOCK
ABRAM T. COLLIER
NORMAN I. ADAMS
ROBERT S. POTTER

Cashier
WILLIAM A. BURNHAM, JR.



Assistant Cashiers
HENRY F. SMITH
FRANK HOUGHTON
FRANK A. NEWELL
GEORGE H. S. SOULE
GEORGE E. FICKETT

Auditor
CLARENCE E. DUNAVEN

Credit Manager
JAMES E. RYDER

Capital \$10,000,000

Surplus \$5,000,000

Undiv. Profits \$3,600,000

BERTRAM CHESTERMAN BECOMES NATIONAL BANK EXAMINER

Bertram Chesterman, who since the organization of the Virginia Banking Department in 1910 has been assistant



BERTRAM CHESTERMAN
National Bank Examiner, Richmond, Va.

to Hon. C. C. Barksdale, chief of the banking department, has resigned his position with the state to accept a commission as National Bank Examiner.

Mr. Chesterman's experience in examining banks covers a period of several years. During the past two years he has devoted a considerable portion of his time to credit work, the banking department having sometime ago inaugurated a credit system for its own use.

The Comptroller of the Currency has assigned Mr. Chesterman to a district in northern New Jersey and he assumed his new duties on June 1.

H. G. PROCTOR BECOMES CASHIER OF VIRGINIA BANK

H. G. Proctor, for several years manager of the Richmond County Clearing-House, Richmond, Virginia, has been elected cashier of the Union Savings Bank and Trust Company of Huntington, W. Va.

Mr. Proctor has been active for many years in the work of the American Institute of Banking. He is a past president of Richmond Chapter and in September of last year was elected vice-president of the Institute. He is a graduate of the organization, and his promotion is due to the Institute training and ability.

RESERVE CITY BANKERS ASSOCIATION

At the annual meeting of the Reserve City Bankers Association held recently at Baltimore, J. W. Staley was elected president. Mr. Staley is also vice-president of the People's State Bank of Detroit, Mich. In 1918 the association will meet in New York City.



MODERN BANK BUILDING RECENTLY COMPLETED FOR THE
WESTBROOK TRUST CO., WESTBROOK, ME.

THOMAS M. JAMES
ARCHITECT

185 DEVONSHIRE STREET.

BOSTON, MASS.

PROMOTIONS IN NEW ORLEANS BANK

At a recent meeting of the directors of the Hibernia Bank & Trust Co. of New Orleans, P. H. Wilkinson, assistant bond officer, and L. V. DeGruy, assistant trust officer, were made bond officer and trust officer respectively. Mr. Wilkinson has been connected with the bond department of the institution ever since the establishment of the department. Previously he had served as assistant cashier of the Delta Trust & Banking Company of Vicksburg. Mr. DeGruy has been with the Hibernia Bank for the past twelve years.

CHICAGO BANK REPORTS PROSPERITY

The last financial letter of the National City Bank of Chicago reports local prosperity. The bank states:

"High wages and steady work for everyone capable of earning an honest dollar are factors accounting for the phenomenal spending power of this community. Retail sales in dry-goods

show up larger than last year, but the advance buying has been more cautious and merchants who have stocked up with high priced merchandise are no longer anticipating the demands of their customers in the way that they did a few months ago. The great industries are, however, booked well ahead and the demand for ship-plates has made it very difficult for steel manufacturers to fill their requirements in other directions. All branches of the industry appear to be assured of excellent earnings for some time to come. The demand seems to keep up, notwithstanding a steady advance in prices

BANKS ORGANIZED, FINANCED, BOUGHT AND SOLD, everywhere; ample funds always on hand for good new, or old dividend paying bank stocks, carrying official positions. Highest class, confidential selling and buying service rendered banks, bankers and investors. JOHN P. JONES, Monadnock Block, Chicago, Ill.

Is It Not Sound Policy

to send your Baltimore business to the bank whose half century of experience gives assurance of efficiency and strength?

For the handling of collections and all other banking business, this institution is admirably equipped.

Large capital, surplus and resources enable this bank to offer you complete banking facilities and services which are real and not visionary.

The National Exchange Bank Baltimore, Md.

Capital & Surplus, \$2,480,000 Resources, \$12,048,000

WALDO NEWCOMER, President

SUMMERFIELD BALDWIN, Vice-Pres.
CLINTON G. MORGAN, Asst. Cash.

R. VINTON LANSDALE, Cashier
JOSEPH W. LEFFLER, Asst. Cash.

and it looks as if middle Western plants would have all the work that they can handle for the next twelve months. The demand for groceries and foodstuffs seems insatiable. It is evident that the purchase of supplies for army and navy use has been a factor in maintaining prices at a high level. This is natural under the circumstances, in view of the world-wide shortage of foodstuffs and the necessarily large consumption by men in the trenches."

JAMES HURST BECOMES PRESIDENT OF CENTRAL BOND AND MORTGAGE CO.

James Hurst, who for over twelve years has actively been associated in the management of the National Bank of the Republic of Chicago, retired from his duties as third vice-president on June 1 to become the president of the Central Bond and Mortgage Co. The Central Bond and Mortgage

Co. has resources of over \$1,500,000 and its business consists of the purchase of manufacturers' accounts, bills receivable and motor truck paper.

THE NATIONAL BANK OF THE REPUBLIC IS OPTIMISTIC

The June financial letter of the National Bank of the Republic, of Chicago, states that prosperity seems assured. Further, the bank states that modern warfare calls into use every material resource of a country, including its whole machinery of production and distribution. The maintenance of our powers at their greatest efficiency makes the continuation of prosperity not only highly desirable, but, indeed, imperative. If the experience of the Allies is worth anything, little apprehension need be felt as to the ability of our industries to thrive under a war régime. We are dependent upon Germany for none of our raw materials. In



DEVELOPING
MAN-POWER
IN
BANKING



Some men, like machines, are replacable at cost, or less. Others are indispensable as the power which propels the modern super-dreadnought.

Modern banking needs these *power* men, men who can solve intelligently the intricate banking problems of today, who can create and develop new business, and who are capable of forming sound banking judgments. And there is a way of developing executive bankers, for the complex problems of present-day banking.

The New La Salle Course in Banking and Finance

offers for the first time, practical and fundamental training in banking—not merely for clerical work, but for the real brain work of modern banking. It makes a concrete appeal to bank officers, directors, cashiers, and bank employees, who have a spirit for the better things in banking.

A Few of the Noted Authorities in Banking and Finance Who Have Made this Course Possible

Elmer H. Youngman, Editor, The Bankers Magazine, New York City
H. Parker Willis, Ph. D., Secretary, Federal Reserve Board, Washington.
George E. Roberts, National City Bank, New York City.
Arthur B. Hall, A. B., Real Estate Expert, Chicago.
Louis Grentner, Editor, Financial World, New York City.
Frederick Vierling, Trust Officer, Mississippi Valley Trust Company, St. Louis.
Edward M. Skinner, General Manager, Wilson Brothers, Chicago.
William Bethke, M. A., Director, Department of Business Administration, La Salle Extension University.
Samuel D. Hirschl, S. B., J. D., Member Illinois Bar, Chicago.
Frederick Thulin, LL. B., Formerly of the Union Trust Company, Chicago.

O. Howard Wolfe, Cashier, Philadelphia National Bank, Philadelphia.
Walter D. Moody, Managing Director, Chicago Plan Commission.
R. S. White, Collection Manager, American Steel and Wire Company.
C. M. Cartwright, Managing Editor, Western Underwriter, Chicago.
Warren F. Hickernell, A. B., Former Editor Brookmire Economic Service.
Irving R. Allen, Sales and Advertising Counselor, Chicago.

60-Page Book "Banking and Finance" FREE upon Request

This publication will be mailed free and post-paid to any bank officer or individual interested. It contains useful information on modern banking questions and shows clearly what this course can do for the individual or for a bank. You owe it to yourself and your business to know about this work. Write for your copy today.

Address

LaSALLE EXTENSION UNIVERSITY

"The World's Greatest Extension University"

Dept. 4312-D

Chicago, Illinois



The Bank With The BUDGET CHEQUE SYSTEM

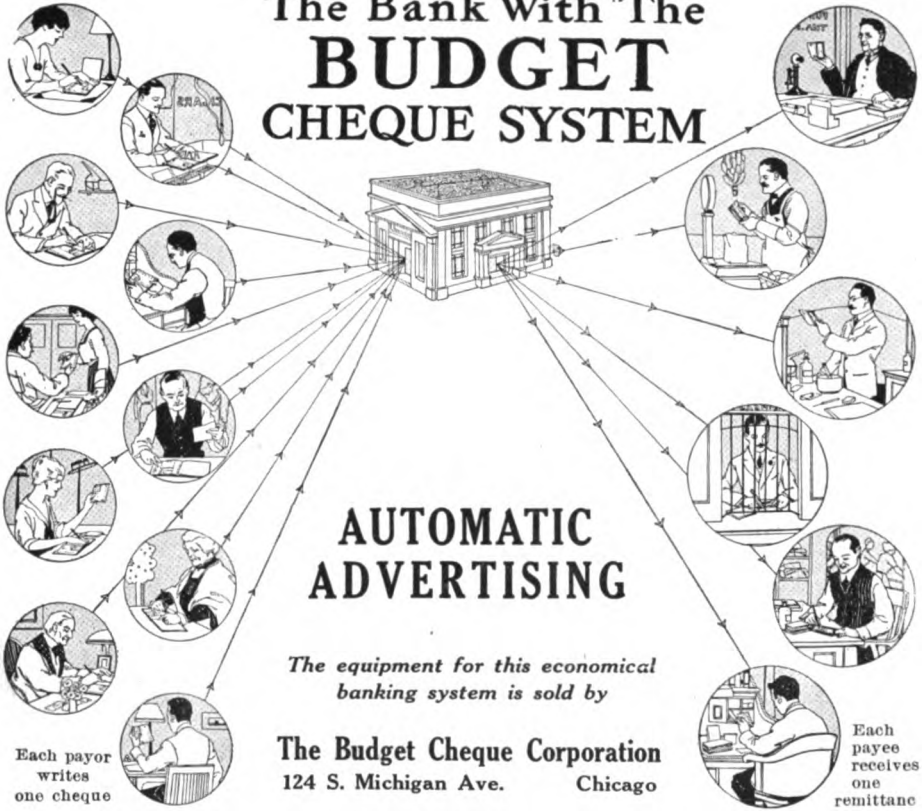

Louis, has issued a statement regarding his opinion of real estate values in and about the city. In part Mr. Lonsdale says:

From close observation I am rather of the opinion that St. Louis real estate values are due for an advance, because this city is backed up by diversified resources, and the earnings of the people now give them a capitalized value which justifies conservative investments, notwithstanding the unsettled conditions existing here and in Europe. However, when talking about war, it is inspiring to know that when you own a home in St. Louis you have something worth fighting for.

**NEW TREASURER FOR AMERICAN SAVINGS
AND TRUST CO. OF SPRINGFIELD, OHIO**

Harry E. Hebrank has become treasurer of the American Savings and Trust Co. of Springfield, Ohio. Mr. Hebrank for some years has been auditor of the Union National Bank of Pittsburgh. He has always been active in chapter work

and has at various times filled all the important offices, including that of president.

Mr. Hebrank has also played a prominent part in the work of the national institute in which he is one of the best known and most popular members. His work on the national publicity committee two years ago was unusually good. Due to the many qualifications that he has displayed, he was elected in 1915 to the National Executive Council of the institute.

The qualities that Harry Hebrank has always manifested in institute work will carry him to continued success in the banking field.

PROMOTIONS IN MILWAUKEE BANK

At a meeting of the board of directors of the Second Ward Savings Bank, Milwaukee, Wis., held June 13, J. U. Lademann, assistant cashier, was elected a vice-president and G. L. Weigle was

We Are Now a Member of the Federal Reserve System

Through our membership in the Federal Reserve System and the St. Louis Clearing House Association, complete facilities are offered Banks and Trust Companies for handling their business in St. Louis and throughout the entire Mississippi Valley, upon most favorable terms.

Complete Financial, Trust, Bond, Real Estate, Safe Deposit, Savings and Farm Loan Departments.

Correspondence Invited

Mississippi Valley Trust Co.

Capital, Surplus and Profits over \$8,000,000

ST. LOUIS



trade are uniformly satisfactory, both in number and in amount—a distinction much to the point in these days when prices are at flood stage and still rising.”

M. E. HOLDERNESS ON BANK ADVERTISING

M. E. Holderness, assistant cashier of the Third National Bank of St. Louis, Mo., recently addressed Tennessee bankers on the subject of advertising. He gave an interesting talk on his experiences and methods in this branch of bank work.

**ST. LOUIS BANKER MAKES ADDRESS ON
COMMERCIAL PAPER**

Frank K. Houston, vice-president of the Third National Bank of St. Louis, at the Reserve City Bankers' Convention, held a short time ago at Baltimore, Maryland, delivered an address on com-

mercial paper, speaking of its uses and abuses.

ST. LOUIS BANK PRESIDENT ISSUES STATEMENT ON ST. LOUIS REAL ESTATE

John G. Lonsdale, president of the National Bank of Commerce in St.

Accurate News of Pacific Northwest

Have You Business or Investment Interests in Washington, Oregon, Montana, Idaho, Alaska or British Columbia?

The authoritative commercial and financial publication of this section is **BUSINESS CHRONICLE OF THE PACIFIC NORTHWEST** issued every Saturday Morning. It tells what you need to know of banking, investments, lumber, fish, apples, agricultural products, mining, foreign trade, railway and marine transportation, commercial and business affairs generally, and analyzes current progress and development. You may rely upon what you see in its columns.

Send for free sample copy. There is no paper like it anywhere.

BUSINESS CHRONICLE

EDWIN SELVIN, Editor
Alaska Building SEATTLE, U. S. A.

The National Stock Yards National Bank

AND

The National Cattle Loan Company

ST. LOUIS NATIONAL STOCK YARDS, ILLS.

Are the largest cattle financing institution in the Eighth Federal Reserve District

WIRT WRIGHT
President

O. J. SULLIVAN
Vice-President

ROBERT D. GARVIN
Cashier

elected cashier. They were also elected directors.

Mr. Lademann entered the employ of the bank in 1887 as a messenger and has held various positions.

Mr. Weigle started as a messenger in 1892 and has also been in the different departments of the bank.

JOLIET BANK BOOSTS LIBERTY LOAN

"The Banker," which is the quarterly financial and business publication of the First National Bank of Joliet, Illinois, devoted its entire June number to the Liberty Loan. The cream of the country's advertising in behalf of the Liberty Loan is commented upon and there are several excellent articles on various phases of the war and business conditions.

KANSAS CITY TO HAVE NEW BANK

Application has been made for a new banking institution in Kansas City, Mo., to be known as the National City Bank with a capital of \$1,000,000. The new institution plans to begin business some time in July at 914 Walnut Street. J. M. Moore, formerly first vice-president of the Southwest National Bank of Commerce, will be president. J. I. Meade, formerly assistant cashier of the Southwest National Bank of Commerce, is to be cashier.

SPOKANE BANKER SPEAKS AT IDAHO BANKERS' CONVENTION

At the annual convention of the Idaho Bankers' Association, held recently at Boise, an address was delivered by W. D. Vincent, vice-president of the Old

SEND YOUR BUSINESS

ON THE

Twin Cities AND THE Northwest

TO THE

CAPITAL AND SURPLUS
TEN MILLION DOLLARS

We are prepared to meet your most exacting requirements and cordially invite you to write to us



National Bank of Spokane, Washington, on banking effectiveness. Mr. Vincent pointed out the many points in banking that should be strengthened and urged that they be developed to their highest possibilities.

CALIFORNIA'S SUPPLY OF CRUDE OIL

That California's supply of crude oil is rapidly diminishing and may possibly not be sufficient to be of great help during the war is the statement of the American National Bank of San Francisco.

Supplies of crude oil on top of the ground have been drawn down more than 21,000,000 barrels in the past two years, leaving on hand not over 38,000,000 barrels, or about a four-months' supply; while consumption is outrunning production about twenty per cent., despite the stimulus for development occasioned by the best field prices producers have enjoyed in ten years. If this condition is allowed to continue, California may fail in part to carry its full share of the National burden in the present crisis, and the wisely-spoken presidential request that all industries be speeded up to maximum capacity, will not bring the response it deserves as being the best preparedness suggestion yet made.

STATEMENT OF THE CROCKER NATIONAL BANK

The last statement of the Crocker National Bank of San Francisco, California, shows total resources of \$40,922,008.00 with deposits of \$31,053,699.81. The bank has a capital of \$2,000,000 and surplus and undivided profits are \$3,903,520.63.

LOS ANGELES BANK INCREASES CAPITAL

The Merchants National Bank which was recently consolidated with the National Bank of California at Los Angeles, has increased its capital from \$1,000,000 to \$1,500,000.

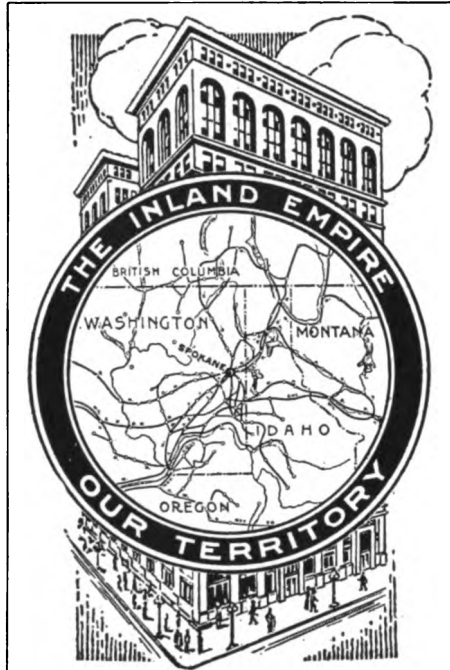

The Old National Bank of Spokane

WITH direct connections in every banking point throughout the "Inland Empire" — a region three times the size of Alabama, of which Spokane is the financial and railroad center — The Old National has the facilities to collect your Pacific Northwest items with exceptional economy and dispatch.

OFFICERS

- D. W. TWOHY, President*
- T. J. HUMBIRD, Vice-President*
- W. D. VINCENT, Vice-President*
- J. A. YEOMANS, Cashier*
- W. J. SMITHSON*
- G. H. GREENWOOD J. W. BRADLEY*
Assistant Cashiers

RESOURCES : \$20,000,000



New and Revised Edition

A Practical Work on Practical Banking **by a Practical Bank Man**

THE latest and best book
on Practical Banking
prepared by an active bank officer of wide
experience, and embodying the methods of
operation employed by the most progressive
banks. Explains in detail the actual work-
ing of each department, particular attention
being given the important subject of banking
credit.

THE PRACTICAL WORK OF A BANK

By **WILLIAM H. KNIFFIN, JR.**, Vice-President
First National Bank, Jamaica, New York City,
Author of "The Savings Bank and Its Practical
Work," "New York Savings Bank Cases," etc.

Contains seventeen chapters and over 600
pages, constituting a comprehensive and
authoritative treatment of all the phases of
bank work.

PRICE FIVE DOLLARS

Carriage Charges Prepaid

THE BANKERS PUBLISHING COMPANY

253 Broadway New York

Ask Your Stationer for
Bankers Linen and Bankers Linen Bond

Made in Flat Papers, Typewriter Papers and Envelopes

They are fully appreciated by the discriminating banker desiring high-grade serviceable paper for correspondence and typewriter purposes

SOLE AGENTS

F. W. ANDERSON & CO.

INCORPORATED

34 Beekman Street, New York

SPOKANE BANK PROMOTIONS

The Old National Bank of Spokane, Washington, has recently promoted several of its staff. B. L. Jenkins has been appointed assistant cashier; J. H. Tatsch, chief clerk, and C. Dahn, assistant to the auditor.

SEATTLE SAVINGS BANKS CREDIT INTEREST TO LIBERTY LOAN PURCHASERS

The Seattle Clearing House Association recently suspended its rules so that all member banks carrying savings accounts could pay full interest on moneys withdrawn to buy liberty bonds up to the date of withdrawal of such funds. Therefore interest was paid depositors who withdrew their money to buy bonds from June 1 to 28. Under ordinary circumstances the money would lose interest from June 1 when withdrawn on the 28th.

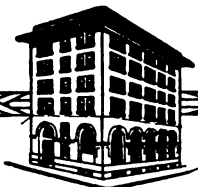

Berkeley, California

YOUR BERKELEY business is invited on the basis of prompt and efficient service. This bank is the oldest in the city and offers advantages worth the consideration of other bankers having business in this locality.

A. W. NAYLOR.....President
 F. L. NAYLOR.....Vice-President
 W. E. WOOLSEY...Vice-President
 W. F. MORRISH.....Cashier
 G. L. PAPE.....Asst. Cashier
 F. H. THATHER....Asst. Cashier

**FIRST NATIONAL
 BANK of BERKELEY**



REPORTS WAR CONDITIONS IN HAWAII

The Trent Trust Company, Limited, of Honolulu, Hawaii, in its last issue of "Trentrustics," in speaking of the war effects on Hawaii, states:

"Sugar prices are bound to remain high and this means a continuation of our prosperity. Notwithstanding this encouraging outlook, the situation is such that economies should be practiced by everyone. With a certainty of generous dividends, and with proper curtailments in expenditures, the investing public should soon find itself in a position to greatly aid the Federal Government by purchasing war bonds. Action along this line should be prompted by patriotic motives, for it is obvious that these bonds are offering but nominal interest.

"The war has undoubtedly had the effect of deferring a distribution of extra dividends. Usually at this time

1917 Convention**American Bankers Association****Sept., 24th-29th.**

First class accommodations will be at a premium. Make your reservation now

HOTEL ST. CHARLES

12 stories of solid comfort (fire proof) directly on the beach. Noted for cuisine and service. Booklet,

Newlin Haines Co.

of the year, when high prices prevail, extra dividends are distributed by the directors of our numerous sugar corporations. The present situation naturally demands a conservative policy and the directors are, no doubt, waiting until such time as they are assured beyond all question that the marketing of our commodity will not be handicapped. Therefore, while extra dividends may be withheld for the time being, a generous distribution will be forthcoming before the end of the year."

**Increasing Savings Deposits**

BANKERS who desire to increase their deposits in their savings department should be interested in the proposition offered by the Stronghart Company of Chicago.

Not only do they furnish home safes and pocket savings banks, but they will agree to distribute these safes through the services of bonded solicitors, getting them into the hands of desirable, prospective depositors.

They will obtain accounts for you at an average cost of from 50c to 60c each, which is about one-fifth the usual fee charged for obtaining desirable savings accounts.

The Stronghart Company are manufacturers of home safes and pocket savings banks, therefore are able to sell at a low price. From manufacturer to banker means a saving to you. Their line consists of sixteen different styles of banks, seven of which are home types, and nine pocket styles. They are able to furnish a bank for every need and give exclusive rights when desired on certain styles or types in certain districts in the various cities.

They have carefully organized their distribution department at no profit to them, but with the main object of increasing their sales on savings banks.

This explains how they are able to furnish service to bankers at a minimum cost.

Some of the largest banking institutions have employed the Stronghart system of obtaining savings accounts, and copies of their testimonial letters as well as complete details explaining their system, and samples of their banks, will be sent to any banker upon request from the Stronghart Company, 1510-12-14-16 South Wabash Avenue, Chicago.

ADRIAN H. MULLER & SON

55 WILLIAM STREET, Corner of Pine Street, NEW YORK

AUCTIONEERS

The Business of Banks, Bankers, Investors and Dealers in Securities generally, receives prompt and careful attention.

STOCKS AND BONDS AT AUCTION

REGULAR AUCTION SALES OF ALL CLASSES OF STOCKS AND BONDS EVERY WEDNESDAY

Real Estate at Public and Private Sale

Prompt Returns on all business entrusted to us



JAMES S. ALEXANDER
President National Bank of Commerce in New York

THE BANKERS MAGAZINE

ELMER H. YOUNGMAN, Editor

SEVENTY-FIRST YEAR

AUGUST 1917

VOLUME XCV, NO. 2

Reciprocity in International Banking

SPEAKING at the Pan-American Commercial Conference at Washington in 1911 on the subject of an "International American Bank," the editor of this MAGAZINE said:

"One thing we must remember, there should be international reciprocity in banking as well as in trade. If we expect to invade Mexico, Central and South America with our banks we must expect the banks of those countries to come here. And if we restrict the operations of their banks here, we may expect them to throw like restrictions around our banks there. Already many foreign banks have agencies in New York and other American cities, but the state laws generally prohibit these agencies from doing a banking business; that is, they may not receive deposits, and thus their ability to make loans is largely curtailed. Can we reasonably expect that Latin America will allow privileges to our banks which we deny to theirs?"

The question thus raised over six years ago has now become one of great practical importance, not merely with reference to Latin America but extending to most of the leading countries of the world.

Under the Federal Reserve Act national banks with a capital of \$1,000,000 and over are authorized, with the permission of the Federal Reserve Board, to establish branches in foreign countries. The same act also empowers national banks to purchase stock in a bank which may be organized for the special purpose of doing business in such countries. (A suggestion also made in the address referred to above and since put into effect by organization of the American Foreign Banking Corporation.)

These provisions are destined to be of very great importance in extending American banking operations in other lands, with the ultimate effect of increasing our permanent foreign trade, as distinguished from that growing out of the war. Already, under the

authority granted in the first of these provisions, several of the larger banks have established branches abroad and others will doubtless do so in the near future.

As intimated above, the other suggestion made by the editor of this *MAGAZINE* in an address delivered at the Pan-American Commercial Conference at Washington in 1911, and later incorporated in an amendment to the Federal Reserve Act, proposing the organizing of an International American Bank, has been put into effect. Under the laws of the State of New York the American Foreign Banking Corporation has been incorporated with a capital of \$2,000,000, the stock being owned by national banks in various parts of the country. This new institution will establish branches abroad and in some cases acquire banks now operating in foreign lands.

These foreign branches of the national banks and the other institutions going into the foreign field, to be of the greatest possible service to our commercial and industrial interests, and in order that their earnings may be sufficient to justify their continuance, naturally wish to have a reasonable degree of freedom of operation in the respective countries in which they are established; that is, they would like, as nearly as possible, to be placed upon a par with the local banks with which they must compete for business.

To assure this, will it not be necessary for some of our states to relax somewhat the restrictions they now throw about branches of foreign banking institutions established in this country?

These restrictions, in New York and some other states, narrowly limit the business of these foreign banks to foreign exchange and a few minor banking functions.

The restrictions of the New York law are of the greatest importance at present, for the reason that New York is the chief foreign trading port of the United States and the city toward which foreign banks desiring to extend their operations to this country naturally turn their attention.

In defining the kind of business permitted to branches or agencies of foreign banks, Section 146 of the New York Banking Law says:

“When the Superintendent shall have issued a license to any such banking corporation, it may engage in the business specified in the immediately preceding section of this article.”

Referring to the preceding section, it is found that the business specified consists of “the business of buying, selling or collecting bills of exchange, or of issuing letters of credit or of receiving money for transmission or transmitting the same by draft, check, cable or otherwise, or of making sterling or other loans, or transacting any part of such business.”

It will be observed that the permitted powers of this section do

not include the two leading banking functions—the receiving of deposits and the granting of discounts—but Section 140 of the New York Banking Law expressly prohibits the exercise of these functions by declaring:

“No corporation, domestic or foreign, other than a national bank or a Federal Reserve Bank, unless expressly authorized by the laws of this state, shall employ any part of its property or be in any way interested in any fund which shall be employed for the purpose of receiving deposits, making discounts, or issuing notes or other evidences of debt to be loaned or put into circulation as money.”

These extracts from the New York Banking Law will sufficiently exhibit the attitude of the Legislature of that state toward the business of branches or agencies of foreign banks located in that state.

These restrictions apply to banks. Now let us see how an outside trust company would be welcomed by the State of New York.

Section 223 of the New York Banking Law, entitled “Prohibition against encroachments upon powers of trust companies,” says:

“No corporation other than a trust company organized under the laws of this state shall have or exercise in this state the power to receive deposits of money, securities or other personal property from any person or corporation in trust, or have or exercise in this state any of the powers specified in subdivisions one, four, five, six, seven and eight of Section 185 of this article [these are the general trust company powers], nor have or maintain an office in this state for the transaction of, or transact, directly or indirectly, any such or similar business.”

Certain of our trust companies, with commendable enterprise, have established branches in London and Paris, and apparently have been well received. Why should not the banking laws of New York and other states be made more liberal, at least to the extent of establishing reciprocal relations?

International banking is like international trade, in that it cannot be all on one side, but must be reciprocal.

Can we reasonably expect that other countries will long permit our banks to enjoy unrestricted privileges on their shores while we continue to throw narrow restrictions around their banks operating here?

It is not desirable, manifestly, that we should relax our laws relating to foreign banks to an extent that would be an impairment of the safeguards deemed essential to all sound banking, or that would give these branches of foreign institutions any advantage over our own banks, but we might safely and wisely permit them much greater latitude in their operations than they now possess.

Were the foreign branches allowed to do a discount and deposit business, they would compete but little with the other banks, because the general public will preferably deal with banks organized under our own laws and managed by Americans. But with these additional privileges the foreign branches could much more effectually serve the special trade and financial interests which they represent. As a matter of fact, experience has shown that the liberalization of banking, within safe lines, results in a general gain in business all around, and in this gain all the banks share.

Many of the great banks of Canada and Europe, of unquestioned soundness, now maintain branches in New York and other American cities. Ought we not, both as a matter of international comity and of self-interest, give to these branches treatment equally liberal to that which we expect foreign branches of our national banks to receive in the various countries in which they may be domiciled?

Unless we do this, it is not improbable that in the near future foreign countries will put up the bars against our banks, either shutting them out altogether or greatly hampering their operations—a result which would be peculiarly injurious to the extension of our banking and trade. That this is no imaginary danger appears from the fact that proposals with this end in view have been made already in more than one foreign country. If this has been done now, when the countries of the world are eager for the credit and capital which our banks may bring them, may we not look for an increase of this tendency with the keener banking and commercial competition that will follow the close of the war?

To bring this matter more clearly before the public, it might serve a useful purpose if the Comptroller of the Currency would collect and publish in his next Annual Report information in condensed form respecting the restrictions contained in the laws of the respective states regarding the establishment of branches of banks whose head offices are located in foreign countries.

Presumably, legislative action in this matter must originate with the respective states rather than with the Federal Government, but it would serve a useful purpose to have at hand information giving the present state laws on the subject. There exists ground for regret that the states may legislate in this matter in a way that may ultimately work to the disadvantage of the national banks seeking to extend their operations in foreign countries, and that will be injurious to our future international trade policy.

Besides collecting the information above mentioned, it might be advisable as well to have our consuls in foreign countries gather and forward for simultaneous publication summaries of the laws of the respective countries in regard to the location within their

borders of branches of banks whose principal place of business is situated in some other country.

The Federal Reserve Act very wisely provided for the extension of the activity of the national banks into foreign countries, and it would be most unfortunate, especially in view of prevailing conditions, if the restrictive policy which many states have drawn about the conduct of foreign banking should provoke a degree of retaliation from other countries which would completely nullify this wise and beneficent provision of the Federal Reserve Law.

THE CHANGE IN RESERVE REQUIREMENTS

BY amendments to the Federal Reserve Act, approved June 21, some important changes were made in regard to the required reserves to be held by national banks. The most sweeping of these changes consists in the entire abolition of the requirement that a bank should hold any reserve in its own vaults. In other words, all the legal reserves of a bank must consist of balances with the Federal Reserve Banks.

The immediate explanation of this marked departure from our former banking policy is that it will release some \$300,000,000 of gold, which can be used as the basis for further expansion of credit, and it is pointed out that such expansion will be necessary to meet the extraordinary demands arising from the war.

Another change in regard to banking reserves is also to be noted, namely, the transfer of all legal bank reserves from reserve agents to the Federal Reserve Banks. This, of course, is a change which would have been effected under the law any way next November, hence the amendments only advance the time of the change, making it effective from the middle of July.

On time deposits all classes of banks are now required to hold a reserve of three per cent. only. On other deposits the reserve which the law demands is as follows: Country banks, seven per cent., instead of twelve as formerly; reserve city banks, ten per cent., instead of fifteen, and central reserve city banks, thirteen per cent. instead of eighteen. These are reductions from the requirements contained in the Federal Reserve Law as originally enacted. At first, under the law, the reserve against time deposits was five per cent., while the total of reserve required was twelve per cent. for country banks, fifteen per cent. for reserve city banks and eighteen per cent. for central reserve city banks. Prior to the enactment of

the Federal Reserve Law, the requirements had been fifteen per cent. for country banks and twenty-five per cent. for other banks. The country banks, however, were required to keep two-fifths of their reserves in their own vaults, but might deposit the other three-fifths with a bank in a reserve or central reserve city. Banks in reserve cities had to hold one-half of their twenty-five per cent. reserve in their own vaults, but could deposit the other half with banks in the central reserve cities. The banks in the central reserve cities, under the old law, must keep all their legal reserves in their own vaults.

It will thus be seen that no classes of the national banks are any longer custodians of any part of the legal reserves of other banks or even of their own legal reserves. It is necessary to bear in mind this word "legal," for many banks habitually hold reserves far in excess of what the law requires, and they will, of course, continue to do so, keeping these extra reserves either in their own vaults or with other banking correspondents as convenience may dictate.

The ease with which banks may now temporarily augment their reserves by rediscounting with the Federal Reserve Banks tends to render unnecessary the keeping on hand of reserves as large as were formerly required. Furthermore, as the Federal Reserve Banks were created chiefly as reserve institutions, it was but natural that in the course of time they should become the sole custodians of the legal reserves of national banks. Under the pressure of circumstances this development has come about earlier than might otherwise have been the case.

NATIONAL BANK GIVES UP CIRCULATION

RECENTLY announcement was made by the National Bank of Commerce in New York that the small amount of notes it had heretofore kept outstanding had been retired. Until lately the National Banking Act required all national banks to invest a certain proportion of their capital stock in United States bonds, without regard to whether they issued circulating notes or not. Some of the banks cared little for the circulation privilege, but inasmuch as they were compelled to buy the bonds anyway, they actually put out the notes which their holdings of bonds permitted. There were, on the other hand, a few national banks which issued no circulating notes whatever.

Now that the provision of law referred to regarding the invest-

ment by national banks of a portion of their capital in United States bonds has been repealed, it may be expected that other banks will follow the example of the National Bank of Commerce and give up their circulating notes. In so doing they will be relinquishing a privilege which is at present of little profit or use.

But it is by no means certain that the complete relinquishment by the national banks of the right to issue notes, which may take place in time, is to be viewed with unconcern. As this privilege gradually lapses, the national banks, one by one, disposing of the bonds available for use as a basis of circulation, the power to emit notes will pass from these institutions to the Federal Reserve Banks. In a sense, this will not be an entire surrender of the circulation privilege, but a transfer of it to specially organized institutions owned by the national banks themselves. Nevertheless this transfer of the note-issuing function from the national banks to the Federal Reserve Banks takes away from the former a privilege which, under a proper method of note issue, might be of great service to the community and of considerable profit to the banks.

At present the public view seems to hold that the intervention of the Government is essential in the issue of all notes to circulate as money. This would be unobjectionable if the activity of the Government went no farther than to see that the notes were promptly redeemed, thus insuring their safety. But it goes quite beyond that and much farther than many consider necessary or desirable. It remains to be seen whether the present view will gain permanency in the banking policy of the country, or whether it may in the light of experience give way to a more scientific method. Of course, the gradual disappearance of a bond-secured currency clears the way for notes based upon coin and commercial paper—a monetary reform of great importance.

TAXATION AS A MEANS OF REDRESSING INEQUALITIES IN THE DISTRIBUTION OF WEALTH

Distribution should undo excess, and each man have enough.—Shakespeare.

THE present taxation policy of the United States is made the subject of an interesting paper in this number from the pen of Professor E. L. Bogart of the Department of Economics of the University of Illinois. Professor Bogart deals primarily with the general policy of taxation adopted some time ago rather than with the special expedients which the war has made necessary.

Of these latter it may be said, in a general way, that they are unobjectionable so long as they produce the needed revenues without unjust and unnecessary interference with the legitimate business interests of the country.

But Professor Bogart's studies lead him to the conclusion that our taxation policy no longer has for its object the procuring of the revenues required to carry on the public business, but that it seeks to redress inequalities in the distribution of wealth by taking away from those who have large stores of this world's goods and giving to others less fortunately circumstanced. Naturally, this is done through a somewhat indirect process. The authorities do not directly take a million dollars from Mr. Rockefeller and apportion it out at so much per capita among needy citizens. But if they tax Mr. Rockefeller's wealth with a heavy hand, causing him to yield up a large proportion of his annual income, while other citizens are treated more leniently, they reach the same end in an indirect way.

If all forms of wealth were taxed alike, people would probably still complain of their taxes, but at least all would be in the same boat. But when corporate wealth is more heavily taxed than that in other forms, a feeling of inequality naturally arises. That this is being done appears from the fact that the wealth in states like Iowa and Kansas—agricultural wealth chiefly—is much less heavily taxed than an equal amount of wealth in Massachusetts where corporate wealth is large. Now, it must be admitted that a policy of this kind is less unfair than appears on the surface, and may indeed be at least partially justified. If it appears, as many believe, that wealth is going too largely into corporate forms, and that the cities and manufacturing centres are being built up more rapidly than the agricultural sections, a taxation policy that would tend to alter this condition could be defended on grounds of public welfare.

The tendency to impose very heavy income and inheritance taxes, progressing to a point approaching the complete taking of all above a certain figure, would seem to constitute an attempt upon the part of the State and Federal governments to break up large fortunes and to distribute them among the people in the shape of the various improvements and benefits to which the public revenues are applied.

This tendency is not a new one in Europe, though its development here is somewhat recent. It will be interesting to observe its effects upon our great business enterprises. The honors of fortune-building which have heretofore acted as the spur to exertion by our captains of industry may have to be exchanged for some less mercenary form of reward. With the present world chaos, opportunity for honorable exertions and corresponding rewards will not be lacking.

PROPOSED BORROWING BY MEXICO

REPORTS originating in Mexico state that American bankers are to be asked to lend to that country 300,000,000 pesos. Presumably the term "peso" means the "pesos fuertes" of Mexico in the time of Porfirio Diaz, worth about fifty cents in our currency, and not the paper "peso" of the Carranza régime, worth a few cents.

It might be well for the shrewd bankers of America to scrutinize with extreme care the security Mexico proposes to offer for this loan, and to take note of some of the problems of the near future certain to vex that unhappy country.

For several years Mexico has been a prey to numerous hordes of bandits whose depredations have resulted in a large loss of property and of life. In many cases these depredations have been committed against the citizens of other countries, the United States, as the largest investor in Mexico, and having many citizens resident there, being the greatest sufferer of all. The immense claims growing out of these bandit raids are yet to be adjudicated. It is certain that to settle them will require very large sums of money. Meanwhile Mexican finances are in a most deplorable condition. The interest on the debt is long in arrears, the great railway systems are in bad shape physically and almost or quite bankrupt financially. The condition of the masses of the people is pitiable.

But were the economic situation of Mexico less gloomy than it is, a grave question arises as to the propriety of American bankers making a loan to the Carranza government until its status with reference to our own Government is more clearly established. We should not wish to lend money to Mexico if there were any possibility of that country's going over to the side of Germany. Such a possibility has been hinted at, but of late reports from Mexico hint at Allied sympathies. This sudden change of sentiment rather suspiciously coincides with the announcement that Carranza will seek a loan of 300,000,000 pesos in the United States.

Carranza's military history is of such recent date and the details of it have been rehearsed with such frequency in the American press that a repetition here is unnecessary. But it may be both instructive and interesting to the bankers who will be called on to lend money to the "First Chief" to see just what kind of statesman he is as revealed by Mexico's new Constitution, of which he was undoubtedly the real author. A study of this most remarkable document is earnestly commended to them, and particularly Article 33, which says:

“The Executive shall have the exclusive right to expel from the Republic forthwith, and without judicial process, any foreigner whose presence he may deem inexpedient.”

Should the American bankers lend money to Mexico and find difficulty in collecting it they might be constrained to visit the country and seek to attend to the matter personally. What may happen to them is rather unpleasantly foreshadowed by Article 33, above quoted.

It is to be hoped that should the American bankers who venture their funds in Mexico be compelled to go to that country personally to get back their money they may not have the sad experience of the Jews who made loans to a certain English King and becoming troublesomely insistent that their money should be returned, proving, in fact, so annoying to the king that he ordered them expelled from his kingdom and had them crowded aboard ship so unceremoniously that many of them fell into the sea and were drowned.

For American bankers who contemplate making a loan to Venustiano Carranza there are mighty interesting and perhaps dangerous possibilities in Article 33 of the Mexican Constitution.

ORGANIZATION OF A NEW FOREIGN BANK

AS will be seen from information given on another page, the American Foreign Banking Corporation has been organized to conduct banking operations in foreign countries.

The organization of a bank of this character whose stock should be owned by other banks has been repeatedly urged by **THE BANKERS MAGAZINE**. It was suggested in an address by the editor at Washington in 1911 and has formed the theme of several articles published in these pages since that time. It is gratifying to note that these suggestions have been acted on by a group of well-known banks located in various parts of the United States. This distribution of ownership of the capital of the new bank will make it representative of all sections of the country and should render the institution generally serviceable to our manufacturing and trading interests.

It will be remembered that the Federal Reserve Act authorized national banks with a capital of \$1,000,000 and over to establish foreign branches. An amendment of the act also permitted national banks to subscribe for stock in a bank organized specifically for the purpose of establishing foreign branches.

The chief activity under the first of these provisions has been manifested by the National City Bank of New York, which now has, with its affiliated institution, the International Banking Corporation, some thirty foreign branches.

The Mercantile Bank of the Americas, with strong banking connections here, is also pushing its operations into various quarters of the world.

These two movements represent the practical steps taken to extend our banking into foreign countries. In addition a few of the New York trust companies have branches at London and Paris, and one or two national banks besides the one referred to have branches in Latin America.

At the outset of this new development of American banking we are to have a triangular competition, represented by the three institutions mentioned. This seems better than a monopoly and on the other hand it is perhaps best, at least until more experience shall have been gained, that numerous banks should not seek to extend their operations into foreign lands. By uniting to form a bank especially for this purpose greater strength ought to be rendered possible.

The capital of the American Foreign Banking Corporation—\$2,000,000—is modest, but it can be increased as needed. It may be expected also that in the near future other banks than those already interested will become stockholders in the new institution. Most of our banks, even the larger ones, have been slow in taking advantage of the opportunity to establish branches conferred on them by the Federal Reserve Act; perhaps they were waiting for a chance to go in with others. This they now have. It will be interesting to watch this development, which is somewhat novel in American banking.

TRUST COMPANY PROVISION OF FEDERAL RESERVE ACT UPHELD

THE Supreme Court of the United States has rendered a decision sustaining the constitutionality of the provision of the Federal Reserve Act conferring trust company powers on national banks. This particular feature of the law had been held unconstitutional by the courts of Illinois and Michigan, and the recent decision sustaining the law was made in a case that came up on appeal from the Supreme Court of Michigan.

In conferring trust company powers on national banks, Con-

gress merely acted in a way to keep those institutions on a par with the trust companies, which in many states were doing a regular banking business. The trust companies in Michigan were a notable exception, confining their functions solely to the trust company field.

If national banks found themselves in competition with a class of institutions doing a regular banking business and the special business of a trust company besides, the national banks naturally felt themselves at a disadvantage, and to offset this sought for an extension of their powers in a manner that would place them on a substantial equality with the trust companies. It can hardly be considered surprising that their requests were granted by Congress and that this further grant of power to the national banks has been upheld by the Supreme Court of the United States.

It is not without interest to speculate on the future development of banking in this country as the result of recent legislation. National banks have either lost or are in the way to lose some of their former privileges—such as the note-issuing power, acting as public depositaries and as Government fiscal agents and as reserve agents. It would be more accurate to say that these powers have not been lost, but that they have been transferred to the twelve Federal Reserve Banks, owned by the national banks of the respective districts. Or, substantially, that the national banks have found it advantageous to hand over to centralized institutions, owned by themselves, certain functions which they have heretofore performed in their individual capacities. This statement is not quite accurate, however, for the existing national banks did not act quite freely in creating the Federal Reserve Banks, and they not only handed over to them certain functions formerly exercised by the separate banks, but at the same time they likewise yielded up to the Government a goodly share of the profit they had derived from the surrendered duties.

With the loss of some of these functions and the gain of others previously exercised by trust companies and savings banks, the national banks, except from a purely psychological standpoint, approximate very closely in form and substance to a trust company where the latter supplements its fiduciary privileges with ordinary banking functions. Will this fact come to be realized and finally lead the national banks to reorganize under state laws as trust companies, or will the latter convert their present form of organization into that of national banks? To raise this question is by no means to answer it, but one would suppose that in time one or the other of these developments will occur, for what real object is there in preserving a form of banking organization when the special distinction it once embodied has passed away?

FEDERAL LAND BANK ACTIVITY

IF the policy inaugurated by the Springfield (Mass.) Federal Land Bank may be taken as indicative of the general course of those institutions, they are likely to stir up some of the dry bones in banking.

In an appeal issued to the bankers in New England, New York and New Jersey, the Federal Land Bank of Springfield struck the keynote of a campaign it has inaugurated for enlisting the forces within the district in the service to which the land bank is dedicated. That the bank is in the field to stay can no longer be denied. Associations have been formed in every state in the district, six hundred applications for loans, aggregating nearly two million dollars, are on file, and money is being paid out already.

President Robinson puts these questions to the bankers: "Are you quite sure that the farmers in your vicinity have all the money they reasonably need to place their farms upon a paying basis? Are you sure that they get their money on terms which make it possible for them to build and plan ahead? And are you quite sure that the present favorable financial conditions are likely to remain so indefinitely, and that these farmers will not sooner or later be crowded by their mortgagees?"

Calling upon the country banker to encourage the farmers of his community to avail themselves of the facilities offered by the land bank, to help organize a local national farm loan association, to see that the men who will be officers and directors are men of high caliber and responsibility, and even to take a personal interest in the association and act as its secretary-treasurer, President Robinson points out that such service will not be wholly altruistic, and that the flowing in of thousands of dollars of outside money will add to the prosperity of the district. He closes with this personal appeal: "Your prosperity is dependent on the prosperity of the community which you serve. If you aid in this movement you will share in that prosperity. You will reap the additional advantage of having in your bank the deposits of such associations as you encourage. You will gain the good will of the farmers in your district. You will gain new depositors and increased deposits. You have, therefore, a rare opportunity before you. In lending a hand to this movement you cannot well escape deriving a benefit to your bank, while at the same time you can render a signal service to the public. In the present grave crisis in our national life much will depend upon the American farmer's ability to 'do his bit.' Will you help him?"

From this strong appeal—which is furnished THE BANKERS MAGAZINE by the Springfield Federal Land Bank—it will be seen that these institutions (or this particular one at least) will compete with a considerable degree of vigor for the class of business they are created to transact. The banks are invited to take part in this campaign for farm loan business, and the bait is held out to them that by doing so they will add to their own deposits. It may work out this way, for the more prosperity there is on the farms the more of it will overflow into the banks. On the other hand, the banks may not relish the thought of assisting in the creation of institutions that, in some of their functions at least, will come into direct competition with their own operations. To the extent that they transact business outside the domain of the ordinary banks or supply additional funds where needed, they will be welcomed by bankers. Possibly it is too much to expect at the outset that the existing banks will help very much in setting up institutions which many regard as competitors and rivals. But it is not likely that the farm land banks will be antagonized by banks already in the field. It may turn out that the new banks will gradually blaze a way for themselves and that it will be found in the long run that there is room enough for all, as has been the experience of the banks and trust companies.



The Taxation of Wealth

By Professor ERNEST L. BOGART of the University of Illinois

[In the June number of THE BANKERS MAGAZINE, Professor Thomas Sewall Adams of the Sheffield Scientific School of Yale University, discussed the "Concentration of Taxes Upon Wealth and Business." This discussion is continued in the following paper, contributed by Professor Ernest L. Bogart of the Department of Economics of the University of Illinois. It will be seen that Professor Bogart is dealing chiefly with the general State and Federal policies regarding taxation rather than with the special taxes made necessary by our entrance into the war.—Editor BANKERS MAGAZINE.]

THE recent proposal that the Federal Government conscript all incomes over \$100,000 a year in the event of war¹ for the period of such war is the logical culmination of the movement observable during the last half decade to shift an ever larger measure of taxation upon the possessors of large wealth. Whether rightly or wrongly the conviction has been very general that wealth was not bearing its just share of taxation, and the determined effort to correct this situation has resulted in a series of measures which have increased the burdens until they have reached a point which has begun to evoke opposition. It will be profitable to review briefly these various steps.

INCOME TAX OF 1913

The passage of the income tax of October 3, 1913, was necessary in order to make good the losses in revenue involved in the reform and reduction of the tariff, just as the income tax was an integral part of Peel's tax reforms in England in 1842. But another very definite purpose in the passage of this act was that of imposing heavier burdens of taxation upon the possessors of large wealth. Thus Mr. Underwood, the chairman of the House Committee on Ways and Means, in reply to Republican taunts that the income tax

clause was added because otherwise sufficient revenue could not be raised by his tariff measure, answered that the Republicans were blind to the trend of the times; that the Democrats did not propose to pass the bill because they were compelled to, but because "the time has come in this country when the great untaxed wealth of America must and shall bear its fair share of running the Government of the United States. We remove the taxes at the custom house on necessaries purposely to levy a tax on wealth. I wish my friends on the other side to clearly understand this."² "The Republican party, on the other hand," he continued, "has maintained the indefensible system of taxing the poor for five decades . . . and means to continue to tax consumption in this country and let the great wealth of the United States go untaxed."³

Mr. Hull, of Tennessee, who was the real author of the income tax sections of the act, was even more explicit, and asserted that the income tax was intended to shift the burden to those who are best able to pay.⁴ Similarly, Senator Simmons, of North Carolina, chairman of the Senate Finance Committee, stated that "the income section is not framed to supply a deficit in revenue, but, on the contrary, is based on the theory that property should bear its

¹Washington press dispatches under date of March 21, 1917.

²*Congressional Record*, Vol. 50, Pt. III, p. 332.

³*Ibid.*, p. 331.

⁴*Ibid.*, p. 505.

just share of the Federal as well as state taxation, and that therefore the rate of this tax should be fixed with a view to requiring the wealth of the country as reflected in the incomes of the well-to-do to contribute equitably to these expenses."⁵

From Mr. Williams of Mississippi came perhaps the frankest statement of purpose: This bill, he said, marked the inauguration of a new philosophy of taxation and "as it is perfected the taxes upon consumption will dwindle more and more and the income tax will more and more take their place."

We may now turn from a statement of purpose to the record of achievement, and note just what the income tax of 1913 called for. Without attempting to set forth all the details of the law, it is possible to make clear the tendency of the act so far as concerned the taxation of great wealth. The incomes of all single persons in excess of \$3,000 (married persons, \$4,000) were taxed at the rate of one per cent. on the excess over \$3,000 (or \$4,000). This was the normal tax, but there was also an additional tax upon persons whose incomes exceeded \$20,000, which progressed as follows:

Income.	Rate of Tax Per Cent.
\$20,000 and not exceeding \$50,000..	1
50,000 and not exceeding 75,000..	2
75,000 and not exceeding 100,000..	3
100,000 and not exceeding 250,000..	4
250,000 and not exceeding 500,000..	5
500,000 and over.....	6

The highest rate under this tax was therefore seven per cent. (normal and additional) upon the largest incomes.

The yield from the income tax was considerably less in the first year than had been anticipated by the Secretary of the Treasury, but with more experience and a better trained corps of officials more has since been secured from this source. For the three fiscal years since the adoption of this measure the yield has been as shown herewith:⁶

Year	Income Tax Yield		
	Personal	Corporation	Total
1914...	\$28,253,535	\$43,127,740	\$71,381,273
1915...	41,046,162	39,144,532	80,190,694
1916...	67,957,489	56,909,942	128,867,430

The individual income tax for the first year, 1914, was for a period of only ten months, so that it is not quite comparable with the other years, but even after that allowance is made a great increase is observable. The corporation income tax fell off in 1915 owing to the depression in business as a result of the outbreak of the European War, while the increased yield the following year reflects the prosperity of the country during that period. Of even greater interest than the amounts paid into the Treasury are the numbers of persons who were shown by the returns to be in possession of the different incomes. This is shown in the accompanying table:

NUMBER OF PERSONS WITH SPECIFIED INCOMES

Income	Number of returns for year ending		
	Dec. 31, 1914	Dec. 31, 1915	
\$3,000..	\$4,000	79,427	82,754
4,000..	5,000	114,484	66,525
5,000..	10,000	101,718	127,448
10,000..	15,000	26,818	34,141
15,000..	20,000	11,977	15,790
20,000..	25,000	6,817	8,672
25,000..	30,000	4,164	5,483
30,000..	40,000	4,553	6,008
40,000..	50,000	2,427	3,185
50,000..	75,000	2,618	3,660
75,000..	100,000	998	1,501
100,000..	150,000	785	1,189
150,000..	200,000	311	406
200,000..	250,000	145	233
250,000..	300,000	94	130
300,000..	400,000	84	147
400,000..	500,000	44	69
500,000..	1,000,000	91	114
1,000,000 or more..		44	60
Total		357,598	357,515

During the year 1914, the normal tax of one per cent. on all taxable incomes of individuals produced \$12,728,038, while the surtaxes on incomes over \$20,000 a year yielded \$15,525,497. Of this group those with incomes over \$100,000 a year paid \$9,628,381, or

⁵*Ibid.*, p. 2553.

⁶Treasury Report, 1914, p. 30; 1915, p. 16; 1916, p. 17.

about one-third of the total amount paid by individuals.

NEW TAXES REQUIRED ON ACCOUNT OF EUROPEAN WAR

The European War, which broke out in midsummer of the year 1914, immediately affected the revenues of the Federal Government and necessitated the imposition of additional taxes to make good the decline of customs duties. Accordingly the emergency revenue law of October 22, 1914, was enacted, which it was estimated would bring in \$54,000,000 for the fiscal year ending June 30, 1915, and \$44,000,000 in the following year.⁷ This was to run until December 31, 1915, but as it was obvious before that date arrived that the European war would continue much longer, it was extended by joint resolution of December 17, 1915, for another year. On the whole, this act taxed business rather than wealth, for it imposed special taxes on bankers, brokers, theatres, bowling alleys, commission merchants, tobacco dealers and manufacturers, as well as various stamp taxes.

Congress, however, preferred to tax wealth rather than industry and when President Wilson proposed in his message of December 7, 1916, that additional revenue be secured by extending the list of articles in the war revenue emergency act and by expanding the internal revenue system, they objected and refused to carry out his programme. The President recommended an increase in the surtaxes of the income tax law, a lowering of the exemptions, and new taxes on gasoline, naphtha, automobiles, internal explosion engines, fabricated iron and steel products, pig iron, and bank checks. But Congress rejected the whole plan except the increase in the surtaxes on the larger incomes.

It had, however, become evident to all that the European war would continue longer than had been anticipated and that a more permanent tax system

must be provided. It was moreover clear that reliance could not be placed upon customs duties, for imports would doubtless continue to be restricted for a considerable period, even after peace was declared. The necessary revenues must therefore be raised by a further development of some form of internal taxes. The answer to the fiscal problem thus presented was given by Congress in the revenue act of September 8, 1916.

In this act there is a definite return to the principle of taxing wealth, which had been temporarily laid aside in the emergency act of 1914. It contained six titles, covering income tax, inheritance tax, munitions manufacturers' tax, miscellaneous taxes, dyestuffs and printing paper, of which only the first four need concern us. The rate of the normal income tax, both upon individuals and upon corporations, was doubled, being increased from one per cent. to two per cent. At the same time the additional tax rates on personal incomes over \$20,000 were raised and a somewhat finer classification of income groups was introduced. The annexed table shows the rates under the new law.⁸

Income	Rate Per Cent.
\$20,000 and not exceeding \$40,000..	2
40,000 and not exceeding 60,000..	3
60,000 and not exceeding 80,000..	4
80,000 and not exceeding 100,000..	5
100,000 and not exceeding 150,000..	6
150,000 and not exceeding 200,000..	7
200,000 and not exceeding 250,000..	8
250,000 and not exceeding 500,000..	9
500,000 and over.....	10

The tax under this new act begins therefore with two per cent. on the smaller incomes of individuals, jumps to four per cent. on incomes from \$20,000 to \$40,000, and then progresses steadily until it reaches a maximum of twelve per cent. (normal and additional) on incomes in excess of \$500,000 a year. If we add to these charges the corporation income tax of two per cent., which would affect for

⁷Treasury Report, 1914, p. 54.

⁸Bulletin of the National Tax Association, II., 3 (Oct., 1916).

the most part the larger individual incomes, there was a total possible exaction of from four to fourteen per cent.

ESTATE OR INHERITANCE TAX

The principle of taxing accumulated wealth appears even more clearly in the provisions establishing an estate or inheritance tax. This was to be levied on the entire value of the net estate, not upon the distributive shares, a method which made the rates heavier than they appear at first glance, for there were none of the various deductions allowed under the state inheritance tax laws. On the other hand, such a provision greatly simplified the administration. An exemption of \$50,000 might be deducted in estimating the value of the net estate, and various other deductions were allowed for funeral expenses, support of dependents during the settlement of the estate, and similar charges. The tax was progressive according to amount, but not according to kinship, as is usual under the state inheritance tax laws. The accompanying table shows the rates of the Federal estate tax:

Net Estate	Rate Per Cent.
Not exceeding \$50,000.....	1
\$50,000, but not exceeding \$150,000	2
150,000, but not exceeding 250,000	3
250,000, but not exceeding 450,000	4
450,000, but not exceeding 1,000,000	5
1,000,000, but not exceeding 2,000,000	6
2,000,000, but not exceeding 3,000,000	7
3,000,000, but not exceeding 4,000,000	8
4,000,000, but not exceeding 5,000,000	9
In excess of \$5,000,000.....	10

The state inheritance taxes, now levied in forty-two states, range from one per cent. on smaller estates to near relatives to fifteen per cent. on the largest amounts going to distant collateral heirs.⁹ It is therefore conceivable that in the most extreme case an estate might have to bear Federal and state inheritance taxes that would absorb twenty-five per cent. of the entire estate.

A new feature in American finance was the imposition of the munitions manufacturers' tax in addition to the income tax. This was an excise tax of twelve and one-half per cent. of the entire net profits from the sale of such articles manufactured within the United States, to cease at the end of one year after the termination of the present European War. The fourth title of the act imposed miscellaneous taxes on beer, wine, etc., and a special excise tax on corporations, brokers, and places of amusement. The special corporation excise tax is equal to fifty cents for each \$1,000 of the "fair value" of the capital stock, but a deduction of \$99,000 is allowed. The so-called war revenue taxes, levied under the emergency act of October 22, 1914, were repealed.

The debate in Congress on this measure was complicated by the fact that it was a war measure, the larger revenue to be raised being necessitated by the preparedness programme. But in spite of that fact the determination to impose the added burdens upon the few wealthy rather than upon the masses is very evident. As typical of the different viewpoints, we may quote briefly from three or four speakers, both in opposition to and in defense of the bill.

Mr. Hill of Connecticut, who opposed the act, asserted that the Democrats proposed to meet the expenses of defense by "unloading the whole of this additional burden, by a doubled income tax, upon one-third of one per cent. of our population, and in another form upon the graves of the dead, and the surviving widows and orphans, doubling a tax already paid in forty-two States of the Union, and, in still another form, upon very carefully selected industries which you think can be safely plundered and with good results. Is it not robbing the few to pay the equitable obligations of the many?"¹⁰

Mr. Collier of Mississippi stated the Democratic position as follows:¹¹ "We

⁹As in Wisconsin and West Virginia.

¹⁰Congressional Record, Vol. 53, p. 12104.

¹¹Ibid., p. 12136.

have to raise a certain amount of money to provide national defense. Only one question presented itself: How can this be raised so that the burden will fall lightest upon the American people? We have done this by increasing the income tax, and adding the inheritance tax and the tax on munitions."

"This bill provides," said Mr. Keating of Colorado,¹² "for a total of \$225,000,000 of new revenue, and not one dollar of that vast sum will be raised by a tax on the necessaries of life. Every dollar will come from the purses of those who are most capable of making the contribution—the very rich men of the country. It was not until the advent of the Wilson administration that any serious attempt was made to equalize the burden by compelling wealth to bear something like its just share."

Mr. Crisp of Georgia argued for the act in a similar strain.¹³ "The Democratic Party, while having no fight to make on wealth honestly acquired, believes that a man should contribute to the support and maintenance of the Government according to his ability to pay; that great wealth should bear its just and equitable portion of the expense of the Government; and the bill we are now considering raises the entire amount necessary to pay the expenses of preparedness from the wealth of the country."

Perhaps the most radical, not to say vindictive, speech made during the progress of the debate on this measure, was one by Mr. Bailey of Pennsylvania.¹⁴ In spite of mixed metaphor and repetition of trite phrases, his view deserves attention as indicating the attitude of some at least of the supporters of the act. According to him the most important feature of the whole bill was the fact that the burden of the war expenditure was placed on those chiefly responsible for promoting it. This proceeded from Wall Street and from those whose interests centre there.

"They have done the dancing; they must pay the piper. . . . Those who have been financing the National Security League, the Navy League of the United States, the National Defense League, must now finance the great preparedness programme of Congress. . . . Wealth must foot the bills. . . . This is something new under the sun. . . . Always the great and powerful neither did the fighting nor paid the bills. Both fell to the poor and lowly. For once the programme has been changed. . . . We are saying to the men of great wealth, You must shell out. This is your party and you must settle all scores. . . . The country will rather enjoy sitting by and watching our multimillionaire defenders of the national honor do their plain duty. Always before the country has supplied the funds. . . . We shall watch this with a very curious interest and a spice of real satisfaction. Nor shall we weep should wealth set up a howl of anguish, as it is quite likely to do. Let it howl. To the ear of the common people its anguished and outraged cries will be as sweetest music. For wealth has never felt ruth or pity for the masses when the burden and pain were upon them. If we are to have something which approximates an evening-up process, there will be occasion for philosophic satisfaction."

FURTHER IMPOSTS UPON CORPORATE AND PRIVATE WEALTH

Within six months after the act of September 8, 1916, was passed, it was amended so as to increase the already heavy burdens upon corporate and private wealth. On February 1, 1917, diplomatic relations with Germany were severed, and it became probable that war would follow as no change was made by Germany in her submarine warfare. It, therefore, became necessary to provide adequate revenues for all eventualities. The act of March 3, 1917, was accordingly passed, which bore the significant title, "an act to provide increased revenue to defray the expenses of the increased appropria-

¹²*Ibid.*, p. 12485.

¹³*Ibid.*, p. 12109.

¹⁴*Ibid.*, p. 12151.

tions for the army and navy and the extensions of fortifications, and for other purposes."

A novel and important feature of this act was the segregation of the larger part of the revenues to be raised under its provisions for the purposes named in the title and for no other. Preparedness was thus to be financed by the taxes to be described. The first of these is the excess profits tax, which is levied in addition to existing taxes upon the net income of all corporations and partnerships having an income of more than \$5,000, such tax to be at the rate of eight per cent. per annum upon the profits in excess of eight per cent. As the rate of the existing corporation income tax was two per cent. on the net income, it is evident that a corporation whose profits exceed eight per cent. for the year would be subject to a combined tax of ten per cent.

By title III of this act the rates prescribed by the estates tax of September 8, 1916, are increased fifty per cent. Consequently the rates now stand as follows:

Net Estate	Rate Per Cent.
Not exceeding \$50,000.....	1½
\$50,000, but not exceeding \$150,000	3
150,000, but not exceeding 250,000	4½
250,000, but not exceeding 450,000	6
450,000, but not exceeding 1,000,000	7½
1,000,000, but not exceeding 2,000,000	9
2,000,000, but not exceeding 3,000,000	10½
3,000,000, but not exceeding 4,000,000	12
4,000,000, but not exceeding 5,000,000	13½
In excess of \$5,000,000.....	15

Title IV of the act provides for the issuance of \$100,000,000 three per cent. bonds, and \$300,000,000 certificates of indebtedness running not longer than one year, and bearing interest at not exceeding three per cent.

Events continued to move quickly and with war daily drawing nearer even the larger revenues promised by this act appeared insufficient. Further proposals began to be made for additional taxes, and almost without exception these took the form of still heavier impositions upon the rich or upon corporations. A press dispatch from

Washington under date of March 21¹⁵ stated that plans were being made for a new revenue act which should conscript all personal incomes in excess of \$100,000 a year during the period of war with Germany. It was estimated, continued this rather excited correspondent, that such a measure, combined with an increased supertax ranging from five to fifty per cent. on incomes between \$20,000 and \$100,000, would yield between \$2,000,000,000 and \$3,000,000,000 a year. A slight calculation, however, based upon the number of returns made under the income tax law in 1915,¹⁶ is sufficient to show that no more than \$400,000,000 to \$500,000,000 a year could be expected from even such a drastic measure as that proposed.

This same plan was set forth somewhat more coherently and elaborately a few days later by Amos Pinchot and the group associated with him, and petitions urging legislation along these lines were circulated widely.¹⁷ This scheme called for the imposition of a special war income tax, whose rates should range from two and one-half per cent. on incomes from \$5,000 to \$10,000 a year to ten per cent. on incomes from \$10,000 to \$20,000, finally reaching 100 per cent. on incomes in excess of \$100,000. The net profit on all war supplies should be limited to three and one-half per cent. and the profit on foodstuffs and other necessities to six per cent.

REDISTRIBUTING WEALTH BY TAXATION

It must, of course, be borne in mind that some of these proposals are based upon other than purely fiscal considerations, having as their aim the redistribution of wealth, and that in times of excitement and grave national crisis many plans gain a hearing that at other times would have no standing. It is moreover difficult at such times to reach a calm and scientific conclusion. But

¹⁵By a Staff Correspondent, *Chicago Tribune*, March 22, 1917.

¹⁶See page 178.

¹⁷*New York Times*, March 31, 1917.

it is evident from this brief survey of our Federal legislation for the last four years that there has been a very definite intention on the part of Congress to place much heavier burdens upon great wealth and especially upon corporate wealth than these had previously been called upon to bear. This is not a new philosophy, for it had already found expression, though by no means so vigorously, in state corporation and inheritance taxation. But it has been carried a long way forward by the recent Federal legislation.

There is little doubt that under the system of taxation as it developed in this country for fifty years after the Civil War an undue share of the burden of taxation rested upon the masses of the people. The present movement represents a swing of the pendulum in the other direction and an endeavor to readjust the tax system by imposing upon accumulated wealth a larger share. Like all reactions this seems likely to go further and faster than is desirable or warranted. This is especially true in the present crisis when the financial needs of the Government are real and urgent. Under such circumstances considerations that at other times would have weight are brushed aside by imperative necessity, and the most lucrative and easiest sources of revenue seized upon. A carefully balanced and scientific tax programme, which shall take into account the claims and needs of the states as well as the Federal Government, and of different

industrial and economic groups, will probably have to wait now for calmer times, but it is an ideal toward which all thoughtful men may well set their faces.

Before this article appears in print new measures will have been devised by Congress to raise the enormous sums now made necessary by the declaration of war with Germany. Immediate necessities will have to be met by bond issues; but proposals will doubtless be made to finance the larger part of the costs of the war by this method, and to defer their payment for another generation. While bond issues are necessary, it is earnestly to be hoped that they may be issued for as short a term as possible, and that at the same time a vigorous policy of war taxation may be introduced. The method of financing a war exclusively by bond issues was unhappily illustrated by Secretary Chase's policy at the time of our Civil War, and still more recently by the disastrous loan policy of Germany in the present war. If we are to avoid these evils, taxation must be our great reliance for securing the enormous revenues that will be needed—taxation to the very bone, if necessary. Taxes, as such, must be welcomed, not opposed. But one may at the same time voice the hope that the tax system devised under stress of war may meet the same canons of equity, economy, and ability, as well as lucrativeness, that serve as the marks of a desirable system of taxation in times of peace.





TALKS ON BUSINESS BUILDING

By W.R. MOREHOUSE

School Savings Bank

SCHOOL savings banks have received recognition by the press; economists have written on the subject at length; bankers have started them and estimated the results obtained; and in not a single instance is it claimed that school savings banks have produced a profit in dollars and cents to the promoters. Therefore, to the banker whose ambition is centred on the making of money, school savings banks offer no attraction.

WHY SCHOOL SAVINGS BANKS?

If it were not for the fact that a majority of our American parents are neglectful in teaching self-denial, industry and frugality to their children, the need for school savings banks would not be great. Where parents fail in this respect, their children are destined to go out into the world deficient, unless some individual or corporation gives them the requisite training. It is not consistent that we demand good citizenship and independence in our national life when we fail to train our boys and girls along proper channels.

This lack of training in the home has shifted a responsibility upon society which must be met. Individuals and corporations are, therefore, called upon to volunteer their services, that the child who is neglected by his parents may receive a training which will make him industrious and thrifty.

Bankers are doing a very commendable work in this connection, among school children, through school savings banks. Child life in America affords the most fertile field in which to propagate thrift ideals and the principles of good banking, while with the adults it is very different. Our adult population is not thrifty because its efforts are centred on providing ways and means of making money with only a passing thought as to saving a portion of their earnings.

With a school savings bank in every school it would only be a few decades before the American people would become thrifty. Thus there would be less need of almshouses, poor farms, asylums and jails.

EDUCATIONAL

An analysis of the general banking situation discloses the fact that banks are spending hundreds of thousands of dollars annually endeavoring to teach their adult customers the very simplest transactions in banking, and our bankers admit that they are meeting with rather indifferent success. If our banks would apply a similar effort in training school children, banking would soon be as well understood as housekeeping and farming. Where schools refuse to include in their curriculum a course in banking and bank methods, let another method be devised. Or, let the re-

sponsibility be assumed by our schools and banks jointly which would give the propaganda the support necessary in order to insure its success.

THE ORIGIN OF SCHOOL SAVINGS BANKS

In 1834 M. Dulac, a teacher in La Mau, France, proclaimed the "gospel of saving" among school children. However, it remained for Francois Laurent, of Ghent, Belgium, to popularize the idea later and make it a potent factor in school life. That the efforts of both were well directed and fruitful, is evinced by the creditable showing that the people of France and Belgium have since made in saving money.

To Mr. Sereno F. Merrill, of Beloit, Wisconsin, the American people are indebted, for the first school savings bank in the United States. Unfortunately it only survived five years, when it was discontinued because of lack of support on the part of the principal in charge. It was Mr. John Henry Thiry, a native of Belgium, who some years later revived school savings banks in America, finally establishing them on a firm basis in the schools of Brooklyn, New York.

For spreading the gospel of savings among school children in America, great credit is due Mrs. Sara L. Oberholtzer, to Mr. E. G. McWilliam, former secretary of the Savings Bank Section of the American Bankers Association, and to its present secretary, Mr. Milton W. Harrison. To other bankers who are giving of their time and money, and to the school superintendents and teachers who are cooperating in this work, an expression of sincere appreciation is also due.

SCHOOL SAVINGS BANKS IN THE UNITED STATES

According to reasonably accurate statistics, we have 1,925 school savings banks in operation, with a clientele of pupil-depositors of 928,784, and on deposit \$1,792,640.10. This sum appears quite small as compared with the total savings of the American people, but when you realize that it was gathered in pennies, nickels and dimes, it grows in significance.

RESULTS

Any bank promoting savings among school children may expect results from two sources, namely: From school children, who, having saved a stipulated amount in the school savings bank, qualify for an account with a chartered bank; and from the parents of pupil-depositors.

An analysis of the results obtained from both sources will show that while an immediate profit is made on the accounts of the parents, the pupil-depositors will be months in building up appreciable balances.

ADVERTISING FEATURES

Naturally any plan which attracts the attention of school children, and through them reaches the parents, has an advertising value. This value is entirely regulated by the character of the plan; for instance, in the Brooklyn plan there is very little advertising value, while with the stamp plan, owing to the presence of the bank's name on every stamp, the advertising value alone is a large consideration.

THE BROOKLYN PLAN

In briefly describing the Brooklyn plan, no claim is made that it is superior to any other plan, and no reflection on others is intended. There are five plans, with many variations, each adapted to the peculiarities of the locality in which it operates. While every plan is entitled to favorable mention, all but one are omitted for lack of space.

Any banker who is interested will find it well worth while to write to Mr. Milton W. Harrison, secretary, Savings Bank Section, American Bankers Association, 5 Nassau St., New York City, for complete information on School Savings Banks.

The details of this Brooklyn system are handled entirely by the scholars. Eight bright boys from the 7A grade up, that is, boys from twelve to fifteen years of age, are employed as clerks for the boys under the direction of one of the male teachers, known as treasurer of the school bank. Girls are used in the same capacity for the girls.

On Monday, Wednesday and Friday mornings, from 8:30 to 9 o'clock, the bank is open for business. Deposits of five cents or multiples thereof are received. When an account is opened the depositor fills out a signature card in duplicate, in order that same may be filed both numerically and alphabetically. The depositor is also required to make out a deposit slip, and is given a pass card, which is also made out in duplicate, one being retained by the "bank." The card is printed in multiples of five cents both for deposits and drafts. When a deposit or draft is made, one card is placed over the other and the amount punched out, by which an indisputable duplicate record is obtained. The deposit slip is then passed to a boy who records the transaction in a day book, and then another boy who posts it upon the ledger card.

The same procedure is followed in the case of withdrawals. A notice of withdrawal is required, and consent of parents required upon all withdrawals larger than twenty-five cents. The depositor makes out his own checks. When an account is closed, a receipt in

full is taken, and when an account becomes inactive, a notice is sent to the depositor. If pass card is lost a notice must be filed, and a fee of five cents is charged for a new card.

At the end of a day's business, balances on ledger cards and duplicate pass cards upon which transactions have occurred are compared, and must agree, and cash is balanced with day book.

The money of the school bank is deposited with a regular savings bank in the name of the school, subject to withdrawal by teacher in charge, and when the amount to the credit of any individual reaches five dollars it is taken out of the school bank and a pass book issued by the regular bank. No interest is paid by the school bank.

While in this school only multiples of five cents are received, cards might be printed consecutively from one cent to one dollar and the same general result obtained. This system, by its simplicity, seems to overcome many of the arguments that have been raised against the school savings system.



Are Americans Thrifty ?

By F. C. MORTIMER

AMERICANS are looked on by some of the older nations as a people of extravagant habits. It has been said that articles which properly should be classed as luxuries are demanded as necessities; that the cloud of debt lowers over homes that should be basking in the sunshine of financial independence.

Men of affairs who take note of what is going on about them are able to judge how far this is true, and to gauge the tendency to spend more than is earned, noting the encouragement which is held out to the man steadily employed to live beyond his income.

Whatever basis there may be for such criticism in the present, an appeal to the history of our country will show that no such reproach attached to our forebears. The success of the American people has been brought about by the exercise of energy, thrift, levelheaded management.

BANKING SERVICE for WOMEN



Experience With the Women's Department

ONE of the earliest successes in conducting a banking department for women was made by the Second National Bank of New York. Some forty-five years ago, Joseph S. Case, then a teller in that bank, persuaded the directors to fit up a room for the accommodation of women and give them a separate window for the transaction of their business. The bank named was favorably located for the purpose, being convenient to both the fashionable shopping and resident centres. The directors, while consenting to trying out the plan, were not enthusiastic over it. The department opened with five accounts, but Mr. Case lived to see the number increased to more than three thousand with over \$3,000,000 of deposits. At first a small room was provided, with few of the luxurious fittings now commonly found in these departments, but the women were grateful for a place that was exclusively their own, for the services of a maid, and for a teller who would explain to them the intricacies of bank processes, save them from making blunders, or rescue them after they had blundered, with tact and amiability.

The Fifth Avenue Bank in New York has made perhaps the most conspicuous success ever achieved in the field of banking for women. It is not by any means exclusively a women's bank, but has paid special attention to

acquiring and caring for women's accounts. Its location is as nearly ideal for this business as could well be imagined. Near the centre of New York's fashionable shopping and residence district. This is one of the very profitable banks of the country.

The First and Security National Bank, Minneapolis, Minn., has made an exceptional success of its woman's department, as told by Miss Heslup, in charge of the department:

"The prominent place which women have assumed in professional life accounts in part for the larger number of bank depositors and customers among women. The professional, and home woman alike, realize the safety connected with and benefits derived from a good banking connection. To this end we have aimed to interest the women of this city in our woman's department by giving them the best possible facilities by way of spacious banking rooms, complete in attractiveness, and exclusive, entirely separated from the bank proper *and managed wholly by women*. The transaction of all business, even to the opening of new accounts, the certification of checks and the handling of the monthly statements, is carried on entirely in this department, thus giving quick and intelligent service, which is so essential in the banking realm to-day.

"In 1911 we separated our women's accounts from the commercial. The

total deposits at that time approximated \$100,000, with about 1,500 accounts. To-day the figures disclose a total of \$1,564,832 and 5,500 accounts. This is a notable record and we feel qualified to state that the success of this department has depended largely upon two factors: first, the recommendation of those who have received and appreciated the working efficiency and facilities above mentioned; second, extensive advertising. We have realized the importance of this in the securing of new accounts. One method of advertising that we adopted is a separate mailing list of about 6,000 names of new residents and people whose accounts are desirable. When we have anything to offer in the way of advertising we include this list of names with those of our depositors. Many good accounts were obtained in this way, in fact, we began doing this before our department was organized with the result that the largest proportion of accounts we had to begin with was secured through this source.

"Combined with the regular form of advertising through the daily papers, magazines, etc., we have sent out attractive souvenirs from time to time. I might mention that these souvenirs are absolutely free from all advertising matter, but as they are mailed out a card is enclosed paying the compliments of our woman's department. One that proved to be very popular was a little bronze desk calendar in the form of a standard. It won favor because of the fact that it could be used from year to year by replacing the new year's calendar pad upon the old standard. This was followed some time later by a blotter holder (the new blotters being sent out each month), a book mark and letter opener, all of the same bronze design and finally completing a desk set. Another time we sent out a little leather memorandum case, equipped with a gilt-edged memorandum pad and pencil. An attractive feature about this was the name of the recipient upon the inside cover in gold letters. Fillers for these cases are sent out every month or two. On one occa-

sion we got out a household journal which we thought might interest the home woman and acquaint them with the knowledge of handling household accounts, paying bills, keeping books, etc., through a banking system. This with the other means described proved good advertising and brought in numbers of new accounts, as well as many notes of appreciation.

"It is very essential, and stress can be put upon the necessity that women tellers should possess a large degree of patience, courtesy and quick intuition. No amount of advertising would suffice were this lacking, for it is apparent that an ill-treated customer is not conducive to increase of business.

"Our department is still young and possibilities great."

The National Bank of Commerce in St. Louis has been active in gaining women's accounts, and the methods used, together with the results, are thus described by Mr. F. H. Staley, of that institution:

"In an endeavor to build up this class of business we fitted up a beautiful marble rest room on the east side of the bank and installed a telephone with free service for women depositors of the bank. This room was supplied with desks and writing materials and some easy chairs. We then announced to the employees in the bank, through the medium of our bulletin board, that we were particularly anxious to make a showing in this line of business, and they were requested to speak of our facilities and conveniences whenever opportunity offered. In the meantime we issued an advertisement in all of the daily papers, as well as the various magazines and society papers in the city, particularly those reaching the higher class of women. Then we took space in several of the programmes of the local plays appearing at the various theatres during the winter, and used the advertisement 'The Woman's Account.'

"The result has been that many women have come in and opened accounts on our general city books, or

have taken out certificates of deposit of three to six months' duration.

"It is the custom of the bank to issue a statement of all accounts each month to depositors, and in order to attract the women's club accounts, charity organizations, etc., we detailed a certain set of men who prepare the statements on the women's accounts in a very complete manner. At the request of the customer these men will post the books, or show the depositor how to do so themselves.

"One of the leading financiers of this country when standing in front of his large institution one day, called attention to the long line of electric coupes at the curb. He said: 'I would rather see a number of those electricians outside of my bank than many a manufacturer's limousine. They are owned by women who have accounts here, and transact their business with us because of the particular service we render. I believe if a banker can get the women to patronize his institution its success is assured.'

"The above remark was made by Mr. Richard Delafield of New York and opened a vein of thought in a western banker's mind that had not previously been touched. The wisdom of the theory is apparent, because we all know that highly-cultured women know the best and insist on getting it. The tone they lend an establishment through their patronage is often more valuable than is generally understood.

"I believe that this movement to attract the bank accounts of women is like many other worth-while projects, largely a matter of education and development. It cannot be done in a day, but it certainly is in accord with the spirit of thrift we are trying to foster in this country. It gives a woman a feeling of independence, yet at the same time shows her the relation of income to expenditures in such a plain manner that there can be no mistake about the moral effect resulting in much good in many instances."

Mr. Frank Merrill, of the Information and Publicity Department of the

Northwestern National Bank, Minneapolis, Minn., writes of that bank's department for women:

"The development of our ladies' department has been a matter of steady growth rather than the result of any special method of advertising.

"It has been established about thirteen years and was the first in the city, I believe, to be installed. The head of the department has been in charge of it nearly the whole length of time and her unusual efficiency is doubtless the cause of the success of the department to a considerable degree. We have advertised the department now and then in the newspapers, but have never carried on a campaign. The number of accounts is nearly 4,000.

"One good feature that may add to its success is that men depositing for the credit of women's accounts have an outside window and are not allowed to enter into the special ladies' waiting-room, which has tellers' windows exclusively for the use of women.

"One of the largest department stores in town coöperates with the ladies' departments of some of the banks by receiving deposits, entering them in the pass books and handing the deposits to the various banks for teachers' accounts on teachers' pay day. This is popular with the teachers and saves the bank considerable trouble as on a busy Saturday we receive from 70 to 100 deposits in this way."

The First National Bank of Syracuse, N. Y., installed a women's department on moving into its new building in May, 1915. The provisions made for the new department are thus stated by President Alfred W. Hudson:

"In planning our banking room, we located the women's department so as to have a retiring-room for the ladies in close proximity to the ladies' teller. This retiring-room, in addition to having a lavatory, is equipped with a telephone, the latest women's magazines, ladies' stationery and writing-tables with complete equipment, together with easy chairs, and a maid always in attendance. The ladies' teller is a young

married man, whom we picked particularly for his politeness and ability in dealing with our women customers. At this window the teller receives and pays. He makes it a point to always furnish new currency, and has specially printed envelopes containing mixed coin for the purpose of convenience in making change.

"When a new account is opened the customer first meets one of the officers, who opens the account, and that officer in turn introduces the lady to the teller. When an account is opened we furnish check-books in different styles, particularly a folded, pocket check-book, which the women find very convenient to carry in their shopping-bags. The day the account is opened a letter is addressed to the new customer, signed by the president, expressing his appreciation for the account, and offering the many facilities our bank affords for the convenience of our clients. On the first anniversary of the opening of the account the president sends out a letter to the customer recalling the fact that the account was opened a year ago, and again offering all of the facilities our bank affords for the customer's use. If by any chance the account is closed, a letter is sent out under the president's signature, regretting the fact, and making inquiry as to whether there has been any reason for the closing of the account which we can remedy, and hoping that when banking accommodations are desired we will be kept in mind.

"As a further inducement to bring people into our bank, we have addressed the women's clubs and organizations of our city, offering them the use of our directors' room for meetings, and find several who are not only pleased with the idea, but are making use of our offer."

Mr. W. H. Bucholz, vice-president of the Omaha National Bank, Omaha, Nebraska, gives the following account of the operation of the women's department of that bank:

"The women's department of our bank has been a very great success. It was started about five years ago. At

that time we had 243 women's accounts in the bank. We have nearly two thousand at this time, the exact number being 1992.

"The department is placed in an attractive portion of our banking-room, is kept supplied with neat stationery, and every comfort provided for the women who patronize the bank.

"The department is in charge of two ladies who wait on the patrons of the bank. Every courtesy is extended, new currency supplied, and judging from the growth of this department, it is very much appreciated by the women of this city."

Located in New York's great shopping centre, the New Netherland Bank of New York City is especially well situated for acquiring women's accounts. Mr. Curtis J. Beard, cashier of the bank, thus describes their experience:

"The women's department was opened here about two years ago, and at the time we opened it we did a little newspaper advertising and also got considerable free space as a matter of news. Besides that, we put a card in the Hudson Tube trains, thinking our proximity to the Thirty-third Street Station of the tube might bring us some New Jersey business.

"The department is growing gradually, but thus far we have not been able to connect the growth directly with any particular form of advertising.

"We handle a good many women's accounts and do not find them much more troublesome than the accounts of men in the same station in life. A good many women apparently prefer to do business in the general banking-room, but we find that some of these women prefer the separate women's department, under some circumstances, when they get acquainted with it. We have given them a whole floor to themselves, with their own paying and receiving teller, and we did this partly to relieve the congestion on the main banking floor.

"We are expecting to send out spe-

cial literature from time to time in the effort to enlarge the business of this particular department, but have an idea that much the best advertising is the recommendation by satisfied depositors.

"We have used circular letters to some extent, but have not found them especially effective in getting women's accounts."

These experiences, to which many others might be added, establish the fact that the woman's department, as conducted by a number of large and well managed banks in various parts of the country, offers a useful banking service to the community and provides a source of enlarged business and increased profit to the bank.

Banking and Commercial Law

CASE COMMENT AND REVIEW

"Attest—Three Directors"

THE readiness with which the directors of financial institutions sign their names to the periodic reports made to the supervising authorities indicates one of two things: Absolute confidence in the executive officials, or blindness to the risk involved.

It is required by law that all such reports be sworn to by the cashier and attested by a committee of directors, as evidence that the report as given, correctly sets forth the condition of the bank at the date stated. These reports are as a rule required to be published in the press for public information, and being so attested and sworn to, convey to those of the public who can interpret them, the standing of the bank, both as a going concern and as an investment possibility. And relying upon such published reports, those of an investing turn of mind may, if they choose, purchase its shares for profit and income.

The question arises: What obligation does the director assume who thus "attests" the report? It is obvious that he must either do so upon the in-

tegrity of the cashier or other officer making up the return, or of his own knowledge of its correctness. The latter is possible only in cases where the directors, either in person or by a hired accountant, make a detailed examination of its affairs. As a rule these attestations are not made with full personal knowledge of the bank's affairs, but casual only.

There is a liability, however, attending such acts that would, if known to the attesting director, make him extremely reticent about signing his name.

In the case of *Chesbrough vs. Woodworth* in this issue, this question is settled by the Supreme Court of the United States, it being held in this instance that a director so attesting a report is liable in his personal and individual capacity for all damages which the association, its shareholders, or any other person, may sustain by reason thereof. In other words, if stock is bought on the strength of such reports, and these reports are false, the directors so attesting are liable to the one so investing for losses sustained. A knowledge of this liability should make directors extremely cautious in making such subscriptions, or making the same,

do so only upon full knowledge of the facts.



“Reasonable Time”

The Negotiable Instruments Law requires that a demand instrument be presented for payment within a “reasonable time” after its issue. The logic of this is clear. If it be held without attempt to collect, the lapse of time may so change the relation of the parties that payment would be difficult to procure; and being payable on demand, it is presumed to be a short time instrument. If presentment would have been difficult or impossible—and there are many such circumstances, a reasonable time may be months and even years, but where the parties are so related to each other that payment could have been easily demanded, delay will be fatal.

In the case of Plymouth Trust Co. vs. Scanlon, in this issue, the instrument was payable on demand. It could have been presented with ease at any time, and a period of fourteen months was allowed to elapse before making demand, and this the Supreme Judicial Court of Massachusetts does not consider a “reasonable time” in the light of the facts.

by U. S. Rev. Stat., Sec. 5211, Comp. Stat. 1916, Sec. 9774, and as called for by him. are made personally liable to one who has sustained a loss by reason of his purchase of stock in the bank in reliance on such false reports, by Sec. 5239 (Comp. Stat., 1916, Sec. 9831), which provides that in case the directors knowingly violate or knowingly permit the violation of any of the provisions of the National Bank Act, “every director who participated in or assented to the same shall be held liable in his personal and individual capacity for all damages which the association, its shareholders, or any other person, shall have sustained in consequence of such violation.” (37 Sup. Ct. Rep.)

STATEMENT OF FACT AND OPINION OF THE COURT

Mr. Justice McKenna delivered the opinion of the court:

Action in ten counts charging plaintiff in error and one Joseph W. McGraw with violating the National Bank Act, and alleging damages resulting to defendant in error therefrom.

In description of the parties we shall designate them respectively as plaintiff and defendants.

In all the counts defendant Chesbrough and McGraw are alleged to have been at certain dates directors of the Old Second National Bank, a national banking corporation organized and doing business under the National Bank Act of 1864, and the amendments thereto, and having its office in the city of Bay City, Mich.

The following violations of the act are charged: (1) Signing, attesting, and permitting and assenting to the publication of, a report of the conditions of the bank required to be made by U. S. Rev. Stat., Sec. 5211, Comp. Stat. 1916, Sec. 9774, of such act, which report was false. (2, 3, 4, 5.) The Comptroller of the Currency having made a requisition upon the bank for a report of the resources and liabilities of the bank upon a day specified, as required by the act, the defendants permitted and assented to a violation of the act by signing, attesting, and permitting and assenting to the publication of, a false report of the resources and liabilities of the bank and its condition at the close of business of

Leading Cases

Liability of Directors

U. S. COURT

*False Reports—Purchase of Stock—
Negligence—Damages*

U. S. Supreme Court, May 21, 1917.

CHESBROUGH VS. WOODWORTH.

Directors in a national bank, who, with knowledge of their falsity, attested reports of the bank's financial condition, made to the Comptroller of the Currency, as required

such day. (6, 7, 8.) Violation of the act in that defendants and each of them permitted and assented to the declaration of the semi-annual dividend, being payable December 1, 1902, knowing that it would necessarily be paid out of the capital stock of the bank, and not out of net profits, and knowing that losses had theretofore been sustained equal to or exceeding the undivided profits then on hand, and that the sums so declared as dividends exceeded the profits then on hand, after deducting therefrom losses and bad debts. (9) Defendants knowingly violated and permitted and assented to the violation of the act (U. S. Rev. Stat., Sec. 5200, Comp. Stat. 1916, Sec. 9761) in that they knowingly participated in, permitted, and assented to the creation of, certain liabilities to the bank, and knowingly permitted and assented to the continuance of the liabilities and the carrying of the same among the loans and discounts of the bank after defendants and each of them had knowledge of the nature and character of the liabilities, and that they had been created and were being carried in violation of the act. The liabilities are set out.

(10) Violations of the act (U. S. Rev. Stat. Sec. 5199, 5200, 5204, 5211, 5239, Comp. Stat. 1916, Secs. 9760, 9761, 9766, 9774, 9831), being portions of a general design and conspiracy on the part of the defendants to deceive the public, including plaintiff, for the purpose of giving the stock of the bank a fictitious market value and enabling each of the defendants and his relatives and friends to dispose of certain shares of the stock then and there held by them at a price exceeding the value of the stock.

In each count damage is alleged to have been caused to plaintiff, he having purchased stock upon the faith of the action of defendants. The total amount of damage is alleged to be \$35,000.

Plaintiff in error Chesbrough (the case is here on his writ of error, McGraw not having joined) filed a demurrer to the declaration, which was

overruled. He then filed several pleas, one of which alleged that he was not guilty of the wrongs and injuries complained of, and gave notice that under the latter he would "insist [upon] and give in evidence" certain matters of defense.

The case was tried to a jury. The 3d, 6th, 7th, 8th, 9th, and part of the 10th counts were withdrawn from their consideration. A verdict was returned for plaintiff in the sum of \$22,662.98, upon which judgment was entered. It was affirmed by the court of appeals. 137 C. C. A. 482, 221, Fed. 912.

This case had once before been to the circuit court of appeals, where its facts were reviewed, and we may refer to the report of the case for them. 116 C. C. A. 465, 195 Fed. 875.

It there appears that in October, 1902, the bank reported a capital of \$200,000, a surplus of \$75,000, and undivided profits of \$27,000. Its total loans and discounts were about \$100,000.

On October 3, 1902, the bank held as loans (so considered by the court and the Comptroller of the Currency) the paper of the Maltby Lumber Company to the amount of \$102,000, which had accumulated under the personal direction of the then president and practical manager of the bank. The Comptroller required that the loan be reduced to the permitted ten per cent. The Comptroller's letter was presented to the board. Inquiry during the next few weeks developed the general character of the Maltby paper and that most of it was not drawn against any real debt, and in fact represented no liability, except Mrs. Maltby's.

Its net worth, shown by a statement of Maltby, who was called before the board, was about \$188,000, but there were many suspicious circumstances about the inventory, and it did not appear how much of this primary liability to the bank was included among the debts. There was subsequently liquidation of the Maltby Company's affairs, and as it proceeded the bank charged off successive amounts of the Maltby paper. In this way the total

loss charged off prior to the trial of the cause (first trial) was \$223,000. A comparatively small amount remained uncollected and not charged off. A generally similar situation existed as to another line of paper, of one Brotherton, upon which \$47,000 had been written off as worthless before April, 1909. The shares of stock were \$100 par value, and the writing off of these two items caused a loss in book value of \$135 per share.

The defendants had been two of the directors for many years, during which time reports to the Comptroller were frequently made and published, as required by the statute, and as called for by him, and continuously until 1904 the entire Maltby line was carried at its face in the "loans and discounts," and was reported as part of the bank's assets. Plaintiff, at various dates from March to December, 1903, bought the bank stock at its supposed market value, averaging about \$151 per share, and aggregating \$15,000 par and \$23,400 purchase price.

The case went to trial to a jury. Certain counts were withdrawn, and upon those submitted a verdict was returned and judgment entered upon it for the amounts plaintiff had paid for his stock, less its then book value, after deducting its pro rata share of the actual loss written off on account of the Maltby and Brotherton paper, with interest,—an average total of \$167 per share.

The following were the rulings of the court:

(1) The general demurrer was rightly overruled. The making and publishing of the reports are not merely for the information of the Comptroller, but are to guide the public, and he who buys stock in a bank in reliance upon the reports has a right of action under Sec. 5239, Rev. Stat. (Comp. Stat. 1916, Sec. 9831), against any officer or director who, knowing its falsity, authorizes such report. "The one suffering such damages is within the statutory description 'any other person.'" The conclusion was deduced from *Yates*

vs. *Jones National Bank*, 206 U. S. 158, 51 L. ed. 1002, 27 Sup. Ct. Rep. 638, and *Yates vs. Utica Bank*, 206 U. S. 181, 51 L. ed. 1015, 27 Sup. Ct. Rep. 646, and other cases in the state and Federal courts.

(2) The damages in such a case are personal to the plaintiff. He sues in his own right, not for the association.

(3) Such action involves no direct showing of negligence; the sole primary issue is whether defendants caused or permitted to be made a statement of the bank's condition upon which statement plaintiff relied to his injury, and which statement defendants knew was materially false. And in the trial of this issue the detailed history of the entire transaction is admissible as tending to show whether the loans were in fact bad, and whether defendants knew that fact. This scienter is the material condition, and plaintiff can select one of the directors as sole defendant, or join others with him.

(4) Considering the evidence, the court concluded that it justified a finding of liability against the defendants, but not to the extent of the judgment. The court was of opinion that the basis of loss to the bank, that is, the amount which should have been charged off, was taken in the verdict and judgment at the sum of \$223,000, and should not have been greater than \$135,000, excluding entirely, as not sustained by the evidence, the Brotherton debts. The court, therefore, reversed the judgment and remanded the case for a new trial.

Plaintiff moved to modify the opinion and judgment in such manner as to permit him to remit such part of it as the court thought was not supported by the evidence, and that, as modified, the judgment be affirmed. The motion was denied.

The second trial resulted again, as we have said, in a verdict and judgment for plaintiff. In reaching them a basis beyond \$135,000 was taken, and the circuit court of appeals held this was error, but gave to plaintiff permission to file within thirty days from the filing of the opinion in the trial court, a written election to reduce the judg-

ment by the sum in which it exceeded the \$135,000 basis.

This was done, and judgment entered accordingly.

The case on the facts involves two simple propositions,—the scienter of defendant when he attested the report to the Comptroller and the circumstances under which two dividends were declared. Upon these propositions twice have juries held against defendant and twice has the circuit court of appeals held that there was sufficient evidence to sustain their verdicts, modifying only as to certain items of damages. In consideration of our reviewing power, and without reciting the testimony, it is enough to say that the findings on these propositions have substantial evidence to support them.

But it is urged that the plaintiff brought this action under Sec. 5239, Rev. Stat. (Comp. Stat. 1916, Sec. 9831), in the circuit court of the United States for the eastern district of Michigan, in which all of the parties resided, and that not that court, but the state court, had jurisdiction.

The cited section provides for a forfeiture of the franchise of a national bank if its directors knowingly violate or knowingly permit the violation of any of the provisions of the National Bank Act, and further provides that in case of such violation "every director who participated in or assented to the same shall be held liable in his personal and individual capacity for all damages which the association, its shareholders, or any other person, shall have sustained in consequence of such violation."

This section was considered in *Yates vs. Jones National Bank*, 206 U. S. 158, 179, and it was held that the rule expressed by it is exclusive and precludes a common-law liability for fraud and deceit. To the same effect are *Thomas vs. Taylor*, 224 U. S. 73, 56 L. ed. 673, and *Jones National Bank vs. Yates*, 240 U. S. 541. Necessarily a Federal question is involved and there was jurisdiction in the courts below. Sec. 5198, Rev. Stat. (Comp. Stat. 1916, Sec. 9759); Sec. 4 of the Act of August 13,

1888, 25 Stat. at L. 436, chap. 866. *Herrmann vs. Edwards*, 238 U. S. 107, 59 L. ed. 1224, 35 Sup. Ct. Rep. 839, is not opposed to this view. It was there held only that the Federal cause of action should be, in the absence of diverse citizenship, stated in the bill to give the Federal court jurisdiction,—a condition that is complied with by the declaration in the present case.

Defendant attempts to distinguish the present case from the cases cited above, and, in 77 assignments of error, concentrated into 18 points, urges the contentions we have noted, and contentions based on the rulings of the trial court in the admission and rejection of evidence and charges to the jury and the rulings of the circuit court of appeals, and attempts to support them by an elaborate and minute argument. Indeed, the whole case is reviewed and all of the deductions made by the lower tribunals from the evidence combated and the contentions reviewed which were disposed of by the circuit court of appeals, in whose decision we concur. To answer it in detail would extend this opinion to repellent length. It is enough to say of them that they show no reversible error.

Judgment affirmed.

37 Sup. Ct. Rep. 579.



Reasonable Time

MASSACHUSETTS

Demand Note—Presentation

Supreme Judicial Court of Massachusetts,
May 25, 1917.

PLYMOUTH COUNTY TRUST CO. VS. SCANLON.

Presentation of a demand note fourteen months after date of issue held not to have been made within a "reasonable time," as required by Rev. Laws, c. 73, Sec. 88, in order to charge indorser, in view of the circumstances of the case.

A "reasonable time" within which a demand note must be presented in order to charge indorser as required by Rev. Laws, c. 73, Sec. 88, is sixty days, in absence of contrary trade usage or peculiar facts to

bring it within section 209, providing that in determining what is a reasonable time the nature of the instrument, usage of trade, and facts of the particular case must be regarded, such time being the period allowed prior to enactment of the Negotiable Instrument Law.

Action by the Plymouth County Trust Company against Ellen J. Scanlon. Judgment for plaintiff. On report at request of parties. Judgment for defendant ordered to be entered in accordance with Rev. Laws, c. 173, Sec. 120, as amended by St. 1915, c. 185, Sec. 1.

STATEMENT OF FACT AND OPINION

De Courcy, J. The main question raised by the exceptions is whether the demand note in suit was presented for payment "within a reasonable time after its issue," as required by the Negotiable Instruments Law. R. L. c. 73, Sec. 88. The note was made by Maurice A. Scanlon, dated November 29, 1910, payable to the order of the plaintiff, and endorsed by the defendant, Ellen J. Scanlon, the wife of the maker. On January 29, 1912, it was presented at the Trust Company for payment, and notice of dishonor was duly sent to the endorser.

The statute expressly provides (section 209):

"In determining what is a 'reasonable time,' or an 'unreasonable time,' regard is to be had to the nature of the instrument, the usage of trade or business, if any, with respect to such instruments, and the facts of the particular case."

It was decided in *Merritt vs. Jackson*, 181 Mass. 69, under this statute, that in the absence of any evidence to show a usage of trade or business to the contrary, or of facts in the particular case to bring it within section 209, a demand note must be presented within sixty days in order to hold the endorser. That case is decisive of the present one. The plaintiff has failed to show that any usage with respect to demand notes has grown up different from that which had the force

of law in this commonwealth for nearly sixty years before the enactment of the Negotiable Instruments Law. Nor were any facts in evidence which render this customary standard inapplicable. The defendant, who endorsed the note for the accommodation of her husband, had no knowledge of his business dealings, or of the fact that he had paid interest on this note. She never was in the plaintiff's place of business, where the note was payable. The earlier notes endorsed by her were time notes, and were paid or renewed at maturity. And while the maker of the note made an assignment for the benefit of creditors July 13, 1911, the demand for payment of this note was not made on him until January 29, 1912; although his place of business was on Main street in Brockton, within two or three hundred feet of the Trust Company.

In some circumstances it may be a difficult question to determine what shall be deemed a reasonable time within which to demand payment of the maker, in order to charge the endorser. *Seaver vs. Lincoln*, 21 Pick. 267. We are of opinion, however, that on the undisputed facts in the present case a demand made fourteen months after the issue of the note was not made "within a reasonable time"; and that the judge should have ruled as requested by the defendant. *Merritt vs. Jackson*, *ubi supra*; *Commercial National Bank vs. Zimmerman*, 185 N. Y. 210; *Anderson vs. First National Bank of Chariton*, 144 Iowa, 251; *Frazee vs. Phoenix National Bank*, 161 Ky. 175. See *Toole vs. Crafts*, 196 Mass. 397, 401, 82 N. E. 22.

The conclusion reached on the main question makes it unnecessary to consider the defendant's exception to the admission of the letter from the attorneys of the maker of the note.

In accordance with the report, a verdict for the defendant shall be entered in accordance with R. L. c. 173, Sec. 120, as amended by St. 1915, c. 185, Sec. 1.

Ordered accordingly.
116 N. E. Rep. 468.

Checks Drawn Against Un- collected Deposits

U. S. COURT

Liquidation — Payment of Checks — Holder for Value

Circuit Court of Appeals, Fourth Circuit,
March 8, 1917.

STANDARD TRUST CO. OF NEW YORK ET AL. VS.
COMMERCIAL NATIONAL BANK ET AL.

A bank credited to the account of its depositor a check drawn on another bank and permitted the depositor to draw out the full amount thereof. The check was dishonored by the drawee bank for want of funds and returned to the first bank, which charged the amount against its depositor's account. At that time the account according to the books of the bank was sufficient to meet the check, but it in fact consisted only of credits given for the deposit of other checks which thereafter proved not to be good. *Held*, that the bank was not merely a holder for collection, but a holder for value, so that it could sue thereon under Revisal N. C. 1905, Sec. 2206, free from defenses available to prior parties.

In an action against a bank for damages caused by its breach of duty as agent to collect a check drawn upon it which there were sufficient funds to meet, *prima facie* proof that the check reached the town in which the bank was located on Friday evening justifies an inference that it came into the hands of the bank next morning so as to be entitled to payment in preference to other checks presented and paid on Monday and which the bank claimed were presented before the check in controversy, and it was error to direct a verdict for defendant at the close of plaintiff's evidence.

Where a bank to which a check drawn against it had been sent, dishonored the check and had it protested, there was sufficient evidence that it had accepted the check for collection, and the bank cannot deny that it had thereby made itself the holder's agent. (240 Fed. Rep.)

Action by the Standard Trust Company of New York and another against the Commercial National Bank and another. Judgment for the defendants, and plaintiffs bring error. Reversed and remanded, with instructions to grant a new trial.

STATEMENT OF FACT AND OPINION

Knapp, Circuit Judge. In the court below a verdict was directed for the

defendants, and plaintiffs bring the case here on writ of error. The transactions which gave rise to the suit are, briefly, these: On October 4, 1910, Sol N. Cone, of Greensboro, N. C., drew his check for \$5,000 on the Commercial National Bank of that place, in which he was a depositor, in favor of Latham, Alexander & Co. of the city of New York, and mailed the same that day to the payees. They received the check the next day and at once deposited it in the Standard Trust Company, with which they did business. It was received and placed to their credit as a cash item, and almost immediately they drew checks against the deposit to its full amount, as they were authorized to do. Though regarded by the bank as in good standing at the time, for all such deposits by them were treated as cash and allowed to be checked out, it appears that they were actually insolvent and soon afterwards went into bankruptcy. On the day this check was deposited, the Standard Trust Company sent it by mail to the Gerard Trust Company of Philadelphia, which received the same the following morning and sent it that day to the Central National Bank of Philadelphia, and this bank the same afternoon mailed the check for collection and remittance to the Commercial National Bank of Greensboro, on which it was drawn, with the indorsement:

"Pay to the order of any bank, banker, or trust company, prior indorsements guaranteed, October 6, 1910, Central National Bank, Philadelphia, William Post, cashier."

The evidence tended to show that in due course of mail the check arrived in Greensboro on the evening of the 7th of October and was received by the bank to which it was sent on the morning of the 8th, which was Saturday. Throughout that day, Cone, the drawer of the check, had a balance to his credit of \$19,432.52, and this amount was still to his credit when the bank opened the following Monday. He was owing the bank at this time the sum of \$10,000, represented by a note not yet due.

Early in the morning of Saturday, Cone attempted to commit suicide, and this led to an investigation which disclosed his insolvency. The bank thereupon charged its note to Cone's account, and on Monday, the 10th, protested the check in question for insufficient funds and returned it to the Philadelphia bank from which it had been received.

In October, 1911, a suit was begun, in a state court of North Carolina, by the Standard Trust Company and the Central National Bank of Philadelphia—the Guaranty Trust Company later coming in as a party plaintiff—against the Commercial National Bank of Greensboro, for the same cause of action as is set up in this suit. In August, 1915, the plaintiffs in that action took a voluntary nonsuit, and early in the following month, nearly five years after the protest Cone's check, this suit was commenced.

In the meantime, the Standard Trust Company had been taken over by and merged into the Guaranty Trust Company, and the Commercial National Bank had likewise been taken over by and merged into the American Exchange National Bank. The nature of the latter merger, and its effect upon the legal rights of the parties, will be presently considered.

As already stated, the trial resulted in a directed verdict for the defendants. The reasons assigned for this ruling do not appear, and we must therefore examine the several grounds relied upon to defeat the plaintiffs' action. It is insisted, in the first place, that the suit cannot be maintained against the Commercial National Bank because it had ceased, prior to December 11, 1911, to have any corporate existence, and was therefore incapable of being sued or made a party defendant. Upon this assumption it is also argued that the action is barred by section 1200 of the Revisal of North Carolina, which in effect limits the right to sue a corporation to three years after its dissolution. For the purpose of this case it may be conceded that, if the Commercial National Bank was actu-

ally "dissolved" in 1911, the lapse of more than three years would serve as a complete defense to the action. But it seems clear to us that this bank has not been dissolved. Indeed, the defendants alleged in their answer:

"That on the 15th day of September, 1911, the Commercial National Bank went into voluntary liquidation in consequence of having sold its assets to the American Exchange Bank, a corporation doing a banking business under and by virtue of the laws of the state of North Carolina; that some time thereafter, to wit, on December 11, 1911, the American Exchange National Bank was organized under the national banking laws, and as such took over the assets of the American Exchange Bank and such of the assets of the Commercial National Bank as had been taken over by the American Exchange Bank."

And in another paragraph is the averment "that it went into voluntary liquidation as of that date," November 15, 1911, and "that it complied with the United States statutes regulating the liquidation of banks," which plainly means, and the defendants do not deny, that proceedings were taken under sections 5220 and 5221 of the Revised Statutes of the United States (Comp. St. 1913, Secs. 9806, 9808). The status of this bank, therefore, is not that of a dissolved corporation under the laws of North Carolina, but that of a national bank which has gone into voluntary liquidation under the provisions of the national banking act. But a bank so liquidated has not terminated its existence or ceased to be a corporate entity. True, it may not longer engage in the banking business or otherwise exercise its customary functions, but it remains nevertheless a corporation capable of suing and being sued. So the Supreme Court distinctly held in *National Bank vs. Insurance Company*, 104 U. S. 54, from which we quote the following:

"It is to be observed that the sections (5220 and 5221) under which the proceedings took place which, it is claimed, put an end to the corporate existence

of the bank, do not refer, in terms, to a dissolution of the corporation, and there is nothing in the language which suggests it, in the technical sense in which it is used here as a defense. The association goes into liquidation and is closed. It is required to give notice that it is closing up its affairs, and in order to do so completely and effectually, to notify its creditors to present their claims for payment. * * *

"If there are claims made which the directors of the association are not willing to acknowledge as just debts, there is nothing in the statute which is inconsistent with the right of the claimant to obtain a judicial determination of the controversy by process against the association, nor with that of the association to collect by suit debts due to it. It is clearly, we think, the intention of the law that it should continue to exist, as a person in law, capable of suing and being sued, until its affairs and business are completely settled. The proceeding prescribed by the law seems to resemble, not the technical dissolution of a corporation, without any saving as to the common-law consequences, but rather that of the dissolution of a copartnership which, nevertheless, continues to subsist for the purpose of liquidation and winding up its business."

In the light of this authority, it must be held that the three years' statute of North Carolina here referred to has no application to this case, because it is not the case of a dissolved corporation, and that the Commercial National Bank was still "a person in law," which could sue and be sued, when this action was commenced. Nor are we able to perceive that the plaintiffs' cause of action, if otherwise made out, was taken away or adversely affected by the fact that a suit was previously brought for the same cause of action in the state court, but discontinued less than a year before the present suit was begun. We find no bar to the maintenance of the action against the Commercial National Bank.

It is next argued that the suit must

fail because plaintiffs are not the owners of the check in question, and therefore not such real parties in interest as are necessary to maintain the action. When the payees deposited this check, it was accepted as the equivalent of cash. They were allowed to draw upon it the same as though they had made a deposit of so much money, and in point of fact they did check it all out on the same day. Shortly afterwards, they went into bankruptcy, and the testimony shows that no dividend will be paid to their creditors. Had this been the only transaction, we think it could not be doubted that the bank became the bona fide owner of the check for full value. The legal effect in that case would be the purchase or discount of a negotiable instrument. But because the bank charged the check to the payees' account, when it came back dishonored on the 13th of October, as the bank had the right to do, and as was the usual course of dealing, and because on that day or about that time the payees had an apparent balance to their credit exceeding the amount of the check, it is contended that as matter of law the check must be regarded as received merely for collection.

The basis of this contention disappears when the facts are examined. That the books of the bank, when the check was returned, showed a balance greater than its amount, is unquestioned; but that balance, for the most part if not altogether, was made up by credits of other checks or similar deposits which were accepted and treated as cash, but which afterwards turned out not to be good. In short, the proof seems convincing that at no time after the payees had drawn out the amount of this check did they have any substantial sum of actual money in the bank, and when their account was closed at a later date they were overdrawn several hundred dollars in addition to the check in question. The practical result therefore was, whatever the form of bookkeeping, that the bank gave \$5,000 for this check and never has or could get back any part of it from the payees. This being so.

we deem it not doubtful that the effect of the transactions under review was to make the bank the owner of this check for value, and to clothe it as such owner with all the rights of a holder in due course of a negotiable instrument. *Armstrong vs. Bank*, 133 U. S. 433; *Burton vs. United States*, 196 U. S. 283; *Manufacturing Co. vs. Tierney*, 133 N. C. 630. And this is the opinion of the Supreme Court of North Carolina, which has passed upon the identical facts here of record and said (*Standard Trust Co. vs. Commercial National Bank*, 166 N. C. 112):

"Plaintiff asserts ownership of the check by reason of its dealings with Latham, Alexander & Co., and, without discussing this phase of the case, we merely state that the facts, as now presented, sustain the contention."

The rights of "a holder in due course" are defined in section 2206 of the Revisal of North Carolina as follows:

"A holder in due course holds the instrument free from any defect of title of prior parties, and free from defenses available to prior parties among themselves, and may enforce payment of the instrument for the full amount thereof against all parties liable thereon."

We are therefore of opinion, as the case is now presented, that the Standard Trust Company became the beneficial owner of the check for value and without notice, and that it or its successor in title, the Guaranty Trust Company, can maintain this action "free from defenses available to prior parties."

We come then to the defense on the merits, which is, in a word, that nothing was shown at the trial which would warrant a jury in charging the defendants with liability. With reference to this contention, it is to be observed that the present suit is not brought upon the check as such, but for damages, measured by its amount, for breach of duty on the part of the Commercial National Bank in failing to collect the check when it was received, and when

the drawer, as is alleged, had an ample balance for its payment. As above stated, the proofs make a prima facie case that the check got to Greensboro on the evening of the 7th, and this would justify the inference that it came to the hands of the officers of the bank not later than the following morning. True, the answer avers, though not in the most positive and unqualified terms, that the check was not received until Monday.

Such an averment, however, would not of itself overcome the contrary presumption; it would still remain a question for the jury. *Davidson S. S. Co. vs. U. S.*, 142 Fed. 315. But whatever the truth in that regard, it is conceded that during the whole of Saturday, the 8th, and at the opening of the bank on Monday, Cone had upwards of \$19,000 to his credit. Even if it be assumed—and it is not now necessary to decide the point—that the bank had the right as against plaintiffs to pay itself the \$10,000 debt that Cone owed it, as it did, there was still a balance in his favor of \$9,432.52, which was apparently available for the payment of this check. And we say this because careful scrutiny of the pleadings and evidence fails to disclose any proof that other checks were paid before the check in question was protested. The allegations of the complaint are to the effect that \$10,000 of Cone's balance was applied to the payment of the bank's debt against him, and \$6,000 to the payment of two of his checks that came in on Monday, two days after the plaintiffs' check was received. The answer alleges that these other checks were paid before plaintiffs' check was presented, but the defendants offered no evidence, and the fact they assert in this regard is not supported by proof. On the face of it, therefore, as the record now stands, a jury could hardly fail to find that the Commercial Bank might have collected this check if it had acted in good faith and with reasonable promptness. For the fact that the check was protested at the instance of the bank is sufficient evidence that it had been accepted for collection, and the bank can

not be heard to deny that it had thereby made itself the holder's agent. *Burton vs. United States*, 202 U. S. 378. Even if the defendants had introduced evidence to sustain their claim there would still be the presumption, arising from the facts above stated, that the check was actually received on Saturday, and this would leave an issue for the jury to determine. Indeed, we go further and hold that if all the checks were received together, or if the others, which concededly did not get to the bank till some time on Monday, were first presented, nevertheless there might be circumstances which would raise a question for the jury as to whether the bank had properly discharged its duty to the plaintiffs. So, from whatever angle the situation is examined, we are led to the conclusion that a case was made for submission to the jury, and it was therefore error to direct a verdict for the defendants.

Upon precisely the same facts, the Supreme Court of North Carolina reached the same conclusion (*Standard Trust Co. vs. Commercial National Bank*, supra), and we quote with approval the following excerpt from its opinion:

"Was the defendant, therefore, as agent and drawee, acting in good faith with the plaintiff in handling its check? As the evidence is now to be considered by us, the jury might well have found, if the case had been submitted to them, that it was not, and, if the facts are not as a jury could find them to be upon this evidence, it is defendant's misfortune that the case stopped short of full proof on both sides."

As against the American Exchange National Bank, it is sufficient to say, without discussion, that the action is barred by section 395 of the Revisal of North Carolina, and for that reason the verdict in its favor was properly directed.

The judgment will be reversed, and the cause remanded, with instructions to grant a new trial.

Reversed.

240 Fed. Rep. 303.

Presentment For Payment

MASSACHUSETTS

Diligence—Agency—Evidence

Supreme Judicial Court of Massachusetts,
May 25, 1917.

IN RE. POOLE.

The holders of a note which, under Rev. Laws, c. 73, Sec. 90, subd. 3, might properly be presented at the usual place of business or residence of the maker, went to the maker's residence, and, finding the doors locked, went around a corner of the house, where they saw a man standing in a stable door about 400 feet away; an open field lying between. They and the man walked towards each other and met in the field, where demand for payment was made on him. There was nothing to show that the stable or the field belonged to the maker, or was used in connection with her residence. Her place of business across the street was not visited for the purpose of making demand. *Held*, that the facts did not show due diligence in making a demand.

Evidence held not to show demand upon any authorized agent of the maker, or any person found at a place where presentment ought to have been made.

Evidence that, six months before an attempted demand for payment of a note, the person upon whom demand was made had visited plaintiff's store a great many times to buy provisions for the maker's family, did not tend to show an agency for receiving demand of payment at a place other than the residence or place of business of the maker.

Evidence that a man, who came towards the residence of the maker of a note, upon seeing the holders and upon whom they made demand for payment, told them that the maker and her husband had gone away and that he was in charge, was not admissible to show that the maker of the note was absent or inaccessible, so as to authorize demand upon any person found at the place where presentment was made, under Rev. Laws, c. 73, Sec. 89, subd. 4, as his assertion out of court and in the maker's absence that he was acting as agent for the maker was hearsay.

Action against Alva P. Poole. There was a finding for plaintiff, and defendant brings exceptions and files a petition to establish the exceptions. Petition for establishment of exceptions allowed, and exceptions sustained.

STATEMENT OF FACTS AND OPINION

* * * The making of a decision in favor of the plaintiff, without passing

upon the defendant's requests for rulings, was a denial of all such requests as were relevant and inconsistent with the decision. *Hetherington & Sons vs. William Firth Co.*, 210 Mass. 8, 18, 19.

The action is by the holder against the indorser to recover the face of a promissory note given on time. One of the requests of the defendant thus denied was that "there was no presentment for payment on the proper day either at the residence or place of business of the maker of the note." In order to recover of the indorser it was necessary for the plaintiff to prove that demand of payment was made upon the maker on the day of maturity of the note. It is not contended that the case is within the exceptions mentioned in R. L., c. 73, Sec. 132. Neither the place of payment nor address of maker were stated in the note. Therefore, by R. L. c. 73, Sec. 90, subd. 3, it would have been enough if the instrument had been "presented at the usual place of business or residence" of the maker. The substance of the evidence on this point was that, on the day of the maturity of the note, the plaintiffs went after dinner to the front door and then to another door of the residence of the maker, knocked and received no answer, and tried both doors, but could not open them; they did not go to the back door of the house, nor to the maker's place of business, which was nearby on the other side of the street, nor to any other building; that they did not see the maker; that, after trying the two doors, they came round the corner of the house and they saw a man standing in a stable door; that the distance between the house and stable was about four hundred feet, an open field lying between. The man and the plaintiffs walked toward each other and they met "in the midst of an open field." Demand was made on this man.

This was no demand upon the maker of the note. There is nothing to show that the stable belonged to the maker or was used in connection with her residence. For aught that appears, it might have belonged to another person and been used in connection with an-

other estate. The same is true of the open field where the conversation took place. The demand was not made either at the residence or place of business of the maker. The circumstance that confessedly the place of business of the maker, which was across the street, was not visited for the purpose of making demand, is significant. The maker lived about three and a half miles from the holders, in a place called Westdale in the town of East Bridgewater. This evidence does not show due diligence in making a demand. *Porter vs. Judson*, 1 Gray, 175; *Demond vs. Burnham*, 133 Mass. 339. It fails also to show demand upon the maker in person or upon his authorized agent, or upon any person found at a place where presentment ought to have been made. See *Granite Bank vs. Ayers*, 16 Pick. 392, 28 Am. Dec. 253, *Bank of United States vs. Corcoran*, 2 Pet. 121, 7 L. Ed. 368, and *Adams vs. Wright*, 14 Wis. 408.

The case is not aided on this point by the further evidence that, before the date of the note, which was six months before the attempted demand, "this man had been a great many times" to the store of the plaintiffs "to buy provisions for the Davidsons," but the plaintiffs did not know his name and made no effort to procure his attendance as a witness at the trial. An agency to buy provisions more than six months earlier had no tendency to show agency for receiving demand of payment on a promissory note at the time in question at a place not shown to be either the residence or place of business of the maker.

Evidence was admitted against the exception of the defendant to the effect that the plaintiffs asked the man who came from the stable about the Davidsons and he answered that Mr. and Mrs. Davidson had gone to Boston and would be back, he thought, about 6 o'clock, and that he "was in charge." This evidence doubtless was admitted to show that the maker of the note was "absent or inaccessible" within R. L. c. 73, Sec. 89, subd. 4. But it was not competent for this purpose. The man's bald assertion made out of court and in the

maker's absence that he was acting as agent for the maker, ought not to have been received. *Haney vs. Donnelly*, 12 Gray, 361. That being out of the case, there was nothing to show that he had any relation to the maker. While his own testimony, if called as a witness, might have been competent to show where the maker was, the repetition in court of what he said was the merest hearsay.

It cannot be said that these errors of law did the defendant no harm. For aught that appears, the judge may have found that there was a sufficient demand, since he denied a request for the second ruling, which was a correct statement of the law.

It is not necessary to determine whether the evidence of a promise to pay made by the defendant after the due day of the note (*Glidden vs. Chamberlain*, 167 Mass. 486) showed that the promise was made under such circumstances of knowledge of the material facts as to justify a finding of waiver of demand (*Parks vs. Smith*, 155 Mass. 26). No finding was made upon this point and the evidence may not be the same at another trial.

The other questions argued need not be considered.

Petition for establishment of exceptions allowed.

Exceptions sustained.
116 N. E. Rep. 114.



“War Convention” Planned For Atlantic City

THE July “Journal of the American Bankers Association” says:

“Immediately after the spring meeting of the executive council, the chief business of the American Bankers Association became participation in the flotation of the Liberty Loan. With that patriotic duty performed, the Association has now turned its attention to arrangements for the annual convention to be held at Atlantic City the week of September 24.

“It will be a ‘War Convention.’ It is not possible at this time to give the names of the speakers who will be heard at the general sessions, as these will be finally passed upon at a meeting of the administrative committee, but it can be stated definitely that if present plans mature the bankers who attend the convention will have an opportunity to make a first-hand acquaintance with men of national and international reputation—the men who are doing the world’s work in the fight of democracy against autocracy. Questions of technical banking interest undoubtedly will have an important

place on the programme, particularly so far as the sections are concerned; but in the general convention, at a time when the main business of the country is war, it is believed that the bankers who rendered such splendid assistance in the first financial drive should have a chance to see in the flesh men whose names are to-day household words and to hear in detail the story of the association’s work on the Liberty Loan.

“Of one thing members of the American Bankers Association can feel certain: there never has been any intention of abandoning the convention because of the war, as has been rumored recently, nor was the matter ever discussed, formally or informally. It is quite possible, and even probable, that the entertainment programme will be curtailed, in view of the fact that American soldiers will be in the trenches by September and convention entertainment on a large scale will hardly be in keeping with the spirit of the times; but as a matter of fact, Atlantic City itself offers such unlimited possibilities for enjoyment that a set programme is almost unnecessary.”

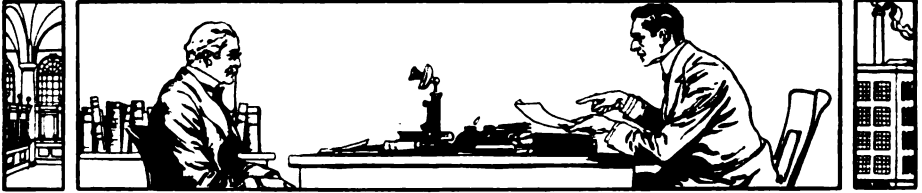

The Business Counselor—The New Factor in Banking

Keeping a Business Up To Date—How the Business Counselor Can Help the Banker

By GEORGE KINGDON PARSONS

[A true story of a business failure which could have been averted. This is the third of a series of articles by Mr. Parsons dealing with the subject of scientific business management and its relation to banking.—THE EDITOR.]

A FEW years ago, while serving in the capacity of business counselor to certain industrial plants in a small Eastern city, I underwent an experience, the recollection of which has become indelibly stamped on my mind. The incident is particularly pertinent to the present series of articles, inasmuch as it serves to illustrate the need, on the part of the banker, for an intimate knowledge of the inner workings of every business to which he stands financial sponsor.

There are many concerns in business to-day which, through years of flourishing existence, have established a prestige which begets confidence. But while preserving outwardly the form of prosperity they are, in the vernacular, on the toboggan. Decay has long since set in. Although the leaves are still green, the root is dead. They are living on reputation—running along on momentum.

It was just such a business that I inadvertently stumbled across through the acquaintance of a banker. The ac-

quaintance itself was quite accidental. In the city referred to above, the happy results of my efforts had been noised abroad to such an extent that I had received considerable friendly attention from leading business men, and, as is the case in small communities, had become known, largely by sight, to a wide circle, among whom was the president of the leading local bank. Having occasion one day to transact business with the bank, I was surprised while standing by the teller's window, at being accosted by a middle-aged man who introduced himself as the bank's president. He shook hands with me warmly, explaining that he had seen me through the glass door of his private room and would like to have a talk with me.

Accepting his invitation, I followed him back to his office, where he first, much to my amusement, subjected me to a course of searching questions, which were, in a way, a challenge both to my profession and personal ability. The situation was very much as if a patient were to put a doctor through a gruelling

examination with a view to ascertaining his ability to cure, but the queries were put with such naiveté that resentment was unthought of. Having satisfied himself that the profession of business counselor was a legitimate one, he proceeded to unburden his mind and place before me the details of a certain proposition which had been giving him considerable anxiety of late.

POURING WATER INTO A SIEVE

Very briefly, his bank, together with one of the bank's largest customers, had for a long time helped to finance and re-finance an old-established foundry and machine shop in the same town. In spite of this constant boosting it appeared that the X Manufacturing Co. had been slowly dropping back year by year to a point where business failure seemed inevitable. The banker was, of course, greatly concerned and asked whether I would be willing to meet Mr. Henderson, the other party to the loan. Having signified assent, an appointment was made, and several days later Mr. Henderson called at my office.

Mr. Henderson was a man of almost eighty—a patriarch with flowing beard and quavering voice—a superannuated business gentleman of the old school—a heroic but sad figure of ante-bellum days, feebly and ineffectually struggling with the fierce on-rushing current of twentieth century business methods.

He had amassed a comfortable fortune and had made numerous safe and profitable investments. Then followed the loans to the X Manufacturing Co. These had not proven so profitable. For several years the company had been borrowing and ever again borrowing—a few thousands here, a few thousands there—to stop up the chinks. But the chinks refused to be stopped. The company could not repay its loans. It didn't seem able to get on its feet.

Mr. Henderson wanted to know where the trouble lay. The business had been established over fifty years, away back in Civil War times. It had always borne a good reputation. Its business integrity was unquestioned.

Never in a single instance had anything happened in its entire history to smirch its name. It enjoyed the good will of its customers. Its products had always been honestly made and were in use by various factories throughout the country. The manager was a man who understood his profession. He had grown up with the business and was widely respected in the community.

What was the trouble? Why didn't the business prosper?

I was unable to answer these questions offhand, but it appeared to me to be a case of dry-rot.

DIGGING INTO PAST HISTORY

A visit to the plant a few days later confirmed this opinion. I was introduced to Mr. Matthews, the manager, a man well past middle life, from whose mind every vestige of initiative and originality had long since vanished, if indeed he had ever possessed those qualities even in the smallest degree. Mr. Matthews was stooped and worried—old before his time. He had spent the greater part of his business years in a futile battle against inevitable conditions. If half the energy and worry expended in this way had been put into intelligent effort to readjust the business to modern conditions, Mr. Matthews' brow would not have been furrowed by premature lines of care.

At the first sight of Mr. Matthews I began to have serious misgivings as to the status of the machine shop. In a flash I visualized the entire organization of that concern, instinctively assuming that the manager reflected the characteristics of the organization. Subsequent developments proved the correctness of my assumption.

During the course of a walk through the plant, evidences of decay were apparent on every hand. The aged capitalist, the manager, the buildings and the machinery were alike, relics of a dusty past. This business, half a century ago, had been a most profitable one, but it had gradually declined. As I stood contemplating the obsolete equipment my mind, through one of

those quick turns which often reveal striking parallels, went back to the prehistoric dinosaur. Yes, here was the dinosaur of the industrial world, slowly trailing its huge, unwieldy bulk along to the inevitable point, extinction, just as its animal prototype had done ages before. Altered conditions were scrapping this business just as they had scrapped the dinosaur—neither had been able to evolve fast enough, but with the dinosaur, the end was fore-ordained. The business could have been saved if nimble wits had applied themselves to the problem.

CLINGING TO OLD TRADITIONS AND PRACTICES

A walk through the plant disclosed an unbelievable condition. Gear wheels and various other parts of machines were piled high on all sides. These, Mr. Matthews explained in a way that seemed apologetic, were made to meet the demand for extra parts where repairs were needed in machines formerly built. Further questioning brought out the fact that some of the machines for which these parts were intended had been manufactured more than twenty-five years ago, and that only a very few of such machines were running, for the obvious reason that they had been supplanted by newer types which would turn out the work quicker and better. Here, then, were thousands of dollars in material and labor tied up in useless junk which could never bring more than the price of scrap metal. While the foundry and machine shop had been working hard to pile up these extra repair parts for its customers, the customers had been throwing away the original machines in favor of newer types. The company had cast to the winds a splendid opportunity to keep abreast of the times by inventing new machinery.

In another part of the plant my attention was attracted by a veritable behemoth of a machine sloughed down with grease. This mammoth piece of mechanism, another relic of antiquity, had formerly been used to perform spe-

cial operations on very large parts of other machines, in the days when machine builders did not carry a full mechanical equipment, but preferred to have some of the heavier operations performed elsewhere. After awhile such concerns began to do this work themselves, many of them building special machinery for the purpose. But in spite of this obvious trend, the management of the X Manufacturing Co. had not been farsighted nor clever enough to push the sale of the big machine under discussion, but simply sat back and allowed others to take undisputed possession of the field.

NEGLECT EVERYWHERE

Everywhere I found similar instances of neglect. In the yard there were pyramids of old castings rusting in the elements—good dollars given over to corrosion. I recognized in these castings parts of a machine which had long since become obsolete, and to my query as to why they were lying there, received the reply that "they were just left over from the early days when the type of machine to which they belonged was discontinued." For a score of years these castings had been "eating their heads off," as the saying goes. In all that time it had never occurred to the management that it would be economy to throw this metal back into the melting pot.

In the store room of the pattern shop I ran my eye over a vast area of shelves which must have contained thousands of patterns. The greater part of these were obsolete.

"Why," I questioned, "haven't you, in addition to simply filling orders, made a specialty of some particular type of machine as a backbone for your business?"

This seemed to puzzle Mr. Matthews. His only reply was, "I really can't say." Those four words epitomized the story of an organization which lacked a real controlling head. Mr. Matthews "couldn't say" because he had never trained himself to think along the lines of business expansion. He was no

doubt a good mechanical man and, from the standards of a decade or two ago, a good business man, but he had failed to keep up to date and to respond to the crying demand for advanced business methods. Everyone about him was of the same type—slow, patient plodders, committed for life to the school of ultra-conservatism.

LACK OF ORGANIZATION

This company did not boast even the nucleus of an organized sales force. A well rounded out selling plan, based on the modern science of merchandising, was unknown to it. As for advertising, such a proposition would no doubt have been looked upon as a sinful waste of money. Business had flowed into the company voluntarily in the first years of its existence, and they had complacently taken it as a matter of course that it would continue to do so. They had not reckoned on competition.

TOO MUCH PRESTIGE

Obsessed with the idea of its own stability and prestige, the X Manufacturing Co. shop had continued along in the even tenor of its way until things began to go wrong. Then came the call for funds. The bank and Mr. Henderson both responded unhesitatingly—what excuse could there be for skepticism in the case of an old-established concern like this! The assets and liabilities had been carefully considered. An audit had shown the true balance of the books. Most assuredly they would advance the necessary money to tide over a temporary bad place. Having done so, the bank and the financier were, a little later, forced to the conclusion that the business was not quite so healthy nor so stable as it might have been. There then remained two things to do, to advance more capital, in order to save the ship, or to pocket their losses and let it go at that. They chose the former course. Just how the bank and Mr. Henderson came out in the long run is a matter on which I am not informed, although I happen to know that

the X Manufacturing Co. is out of business. The point at issue is that there was no excuse whatever for the collapse of this enterprise nor for the loss of a single dollar to anyone concerned.

I made certain recommendations to Mr. Matthews which, with the proper financial support, would have rehabilitated the old business even at that advanced stage of atrophy, but I had no hopes that they would adopt my suggestions or, even if they did, that they would have the ability to carry them through successfully.

FAILURE UNNECESSARY

There is a wonderful lesson in the foregoing incident, for, taken in hand by a live business counselor and reorganized with the intelligent coöperation of a reconstructed force, that old foundry and machine shop could have been made to fairly hum with life and prosperity. And here is the crux of the situation—the failure of the company was not, as might appear at first glance, due so much to the shortcomings of the business itself as to the lack of perspicacity on the part of its financiers. This is a bold assertion, but stop a moment and consider the facts. As intelligent as the man of finance may be, he is not usually conversant with the details of specialized business. That specific and intimate knowledge is lacking which must serve to translate trade idioms into everyday parlance. The tons upon tons of old castings and extra parts lying around the machine shop had no doubt at one time been of great value and, embodied in the report of an auditor, would still appear to be of considerable worth. But stripped of all fictitious value by the analytical methods of the business counselor they would have represented but a poor asset. The same is true of equipment and of many other items which assume rainbow tints in the ordinary financial statement. It is only fair to the banker that every element in the business he is financing, whether it be an immediate asset or a potential market, be represented at its true worth, and it is precisely this de-

sideratum which is assured through the medium of business counsel. Had the banker and Mr. Henderson consulted an expert at an early stage they would not have been so ready to advance funds to a business which, although superficially healthy, was already in the stages of decline. Instead of having nothing for their money but a scrap value for the materials and equipment, together with a pittance for the plant itself, they would at least have been forewarned.

But business counsel goes a broad step beyond mere admonition of danger. It not only points out the pitfalls,

but successfully bridges them. Capital? Yes, the old plant needed it badly, but it also needed the modern inspiration. Under the guidance of a man who understood scientific business management in all its phases, a reorganized force could have made the old machine shop vibrate with industry day and night within a year. All it needed was a rooting up of moth-eaten traditions, a good mental dusting, the infusion of new blood and new ideas, the rejuvenation of dead nerve centres. In a word, this antiquated business needed to be brought up to date—and to be kept there!

How to Handle Liberty Loan Subscriptions

By H. J. HAAS Vice-President First National Bank, Philadelphia

THE bankers of the United States have successfully completed a tremendous task in handling a large part of the subscriptions to the Liberty Loan. The placing of \$2,000,000,000 in denominations as low as \$50 was without precedent in this country, and no detail plan had been advocated for banks to receive subscriptions and take care of future payments, so that they have had to work out their own individual system.

The writer is the originator of a certificate plan which has been found entirely satisfactory, and as we shall no doubt have several more occasions such as we have just passed through it might prove interesting to those who have not found their system adequate for their needs.

The idea of this plan is based on past experience in handling instalments or full-paid subscriptions to stock, making the record complete, minimizing

the labor and dividing it so that any number may cooperate.

Take the following subscription blank (Form A) as an illustration: John Doe desires to subscribe for \$500 in six \$50 coupon bonds and two \$100 registered bonds. He is given Certificate No. 1, as illustrated in Form B, with the first payment of two per cent. recorded on the stub. On the back of the certificate in the centre, from top to bottom, and running the full width it is ruled and spaced exactly as under "Payments" on the stub. The certificate and stubs can be most conveniently handled by binding them in books of 100 each, thus making it possible for any number of people to write certificates, as it is not necessary that they be issued in regular numerical succession. I would suggest that they be numbered by machine and have printed at the bottom "Please present this certificate when making future payments."

A safety paper makes an attractive certificate and in handling future bond issues it might be well to change the color for each issue in order to easily distinguish them. This certificate can

both payment of principal and interest. If for any reason the subscriber should prefer to make payments of different percentages simply cross out those given and insert the new rate.

If for any reason the subscriber should desire to transfer the certificate it can easily be arranged by writing a transfer on the back and having the signature guaranteed.

By marking the subscription blank with the date, number of certificate issued and the initials of party issuing it the possibility of giving two certificates for one application is avoided, and in case of difficulty by arranging the applications in alphabetical order it can easily be located.

By folding the certificate from the bottom up and the top down the payment space can be left in the centre of the back of the certificate and avoid creases, making it easy to record future payments.

Form A

LIBERTY LOAN
APPLICATION FOR BONDS

The application should be transmitted through the subscriber's bank, trust company, or other agency acting on his behalf, or it may be filed direct with the Federal Reserve Bank of the district or the Treasury Department in Washington.

Date: 6/15/17

As an Applicant of the Form:

According to the terms of Treasury Department Circular No. 78, dated May 16, 1917, the subscriber hereby agrees to pay \$500.00 per year of the 15-30 Year U. S. Post Office Gold Bonds of the United States, and agree to pay out and accept interest for any bonds obtained on this application. The rate of 4 1/2% is assumed, being 1/2 per cent. on the amount of money applied for (or payments in full for the sum \$20 on the new \$200 bond applied for).

Signature of applicant or holder: John Doe
Address: 315 Chestnut St
City or town: Phila.
County: Phila.

NOTE—It is desirable that the following information be furnished by the applicant:

- If full payment is to be made before final maturity date indicated on the stubs, enter will be the date of such full payment.
- If it is expected that future payments will be made by check, bank or bank or trust company will such checks probably be drawn?

Name of bank or trust company: _____

Address: _____

3. What, if any, particular qualifications of various certificates are desired? 500
4. Through what, if any, bank or other agency is the application transmitted? 500

6/15/17
J.D.

Form A

be so changed as to handle either instalment payments or full paid subscriptions.

If the regular payments are made no changes are necessary on the stub or back of the certificate and no interest is recorded except when final settlement is made, and perhaps no interest calculation will be necessary on these payments if the government will issue interim certificates with the first coupon bearing interest according to the regular payments.

If the subscriber pays in full when making his application one need only to mark out the percentage and place the payment on the 100 per cent. line, under the column "Amount Due." If after making the first payment he decides to pay the balance the remaining percentages can be bracketed together and the amount paid recorded opposite the last thirty per cent.; the accrued interest collected being inserted in the interest column—one date being sufficient for

Form B

No. 1 Date 6/15/17 \$500 (500) (500) (500)

Issued to John Doe Address 315 Chestnut St

PAYMENTS

DATE	AMOUNT PAID	PERCENT	INTEREST	AMOUNT DUE
June 15	700	100	100	100
June 15				
July 15				
Aug 15				
Sept 15				
Oct 15				
Total	1000			

6/15/17
J.D.

No. 1 \$500 (500) (500) (500)

THE FIRST NATIONAL BANK
PHILADELPHIA, PA.

This is to certify that John Doe has obtained on Five hundred and 00/100 DOLLARS (Five Hundred) UNITED STATES OF AMERICA 15-30 year U.S. gold bonds dated June 15, 1917, and known as THE LIBERTY LOAN. Payments being recorded on the back of this certificate.

The bonds hereby produced as interim certificates are deliverable when and as they are by the United States Government and upon surrender of this certificate with all interest due recorded and amount advanced.

The First National Bank of Philadelphia
6/15/17

Form B

I appreciate that it takes time to make out such a certificate and subscriptions might come in so rapidly that it would be a physical impossibility to deliver them immediately, but having

go into detail regarding the reported subscriptions to the Federal Reserve Bank or the handling of delayed subscriptions. I was prompted to write this article by the number of inquiries received from out-of-town banks, and

if anyone is benefited thereby I shall feel repaid for my efforts.

Forms B and C were not copied after any other bank nor sold by any stationer, neither are they copyrighted, and anyone is privileged to use them.



Reserve Requirements Under the Amendment of June 21, 1917

CIRCULAR No. 74 issued by the Federal Reserve Bank of New York reads as follows:

The amended provisions of the Federal Reserve Act now in effect governing the reserve to be maintained by banks which are members of the Federal Reserve System, are as follows:

"Section 19. Demand deposits within the meaning of this Act shall comprise all deposits payable within thirty days, and time deposits shall comprise all deposits payable after thirty days, all savings accounts and certificates of deposit which are subject to not less than thirty days' notice before payment, and all postal savings deposits.

"Every bank, banking association, or trust company, which is or which becomes a member of any Federal reserve bank, shall establish and maintain reserve balances with its Federal reserve bank as follows:

"(a) If not in a reserve or central reserve city, as now or hereafter defined, it shall hold and maintain with the Federal reserve bank of its district an actual net balance equal to not less than seven per centum of the aggregate amount of its demand deposits and three per centum of its time deposits.

"(b) If in a reserve city, as now or hereafter defined, it shall hold and maintain with the Federal reserve bank of its district an actual net balance equal to not less than ten per centum of the aggregate amount of its demand deposits and three per centum of its time deposits.

"(c) If in a central reserve city, as now or hereafter defined, it shall hold and maintain with the Federal reserve bank of its district an actual net balance equal to

not less than thirteen per centum of the aggregate amount of its demand deposits and three per centum of its time deposits."

You will note that the entire legal reserve of a member bank is now to be maintained on deposit with the Federal reserve bank, and there is no requirement of law as to the amount or kind of currency to be held by a member bank in its own vault. Consequently, the amount to be so held is left to the discretion of each member bank and may consist of Federal reserve notes or other currency.

Member banks in New York City are requested to increase their reserve deposits with the Federal Reserve Bank of New York to an amount equal to thirteen per centum of their net demand deposits and three per centum of time deposits not later than June 27.

Member banks outside New York City are requested to increase their reserve deposits with the Federal Reserve Bank of New York to seven per centum of net demand deposits and three per centum of time deposits for country banks and ten per centum of net demand deposits and three per centum of time deposits for reserve city banks, not later than July 15th.

It is suggested that the necessary increase in deposits may be made gradually between now and the above date by the shipment of any form of gold coin or currency other than national bank notes. For this purpose shipments of gold coin by express, and of gold certificates or properly sorted lawful money and Federal reserve notes can be made in accordance with the terms of our Circular No. 54, all at our expense.

Failure to maintain the additional reserve required by the amended Act to be on deposit with this bank, will not be penalized until after July 15.

Banking and Business Training for Women

THE call for men in large numbers to engage in military and naval service leaves vacant many places in nearly all lines of employment, some of which must be filled by women. Already the depletion in the ranks of bank employees is being made good to some extent from this source, thus following a course which was adopted by a number of the great banks of London, and with good results, under similar circumstances.

The employment of women in banking is not of course new, for they have long been engaged in filling various positions in banks, occasionally becoming officers. In the opinion of not a few bankers, women are exceptionally fitted for work of this character—their neatness, deft handling of money and

papers, tact and a certain intuitive judgment all being qualifications that count in their favor.

It is certain that should the war last long enough to call a large American force into action, there will be a considerable demand for women to take up the tasks the men have surrendered, and one of the phases of employment likely to witness an important substitution of female employees will undoubtedly be in banking.

Having this probability in view, there has been opened in New York The Financial Center for Women, offering practical training for women who wish to take up work of this character. A number of earnest young women are already engaged in the studies considered helpful in fitting them for their new oc-



Photo by Paul Thompson

To fill the places of bankers called to the colors many young women are training themselves in the mysteries of finance

cupation—including an intensive study of the work of each department in a bank, such as receiving and paying tellers, loan and credit, accounting, etc., and such details of money and banking as are included in the following, among other topics: money, the different kinds, how issued and various functions; checks and other negotiable instruments, the marks of genuineness and the law relating to signatures and endorsements. stop-payments, stale, post-dated and

bankers in New York and other cities. In more normal times the bankers might be less disposed than they are now to welcome women into the ranks of their employees, although in some of the larger banks and trust companies women already constitute a large percentage of the total number employed. Just now the employment of women, not only in the large city institutions with their hundreds of assistants, but even in the smaller country banks, will prove a

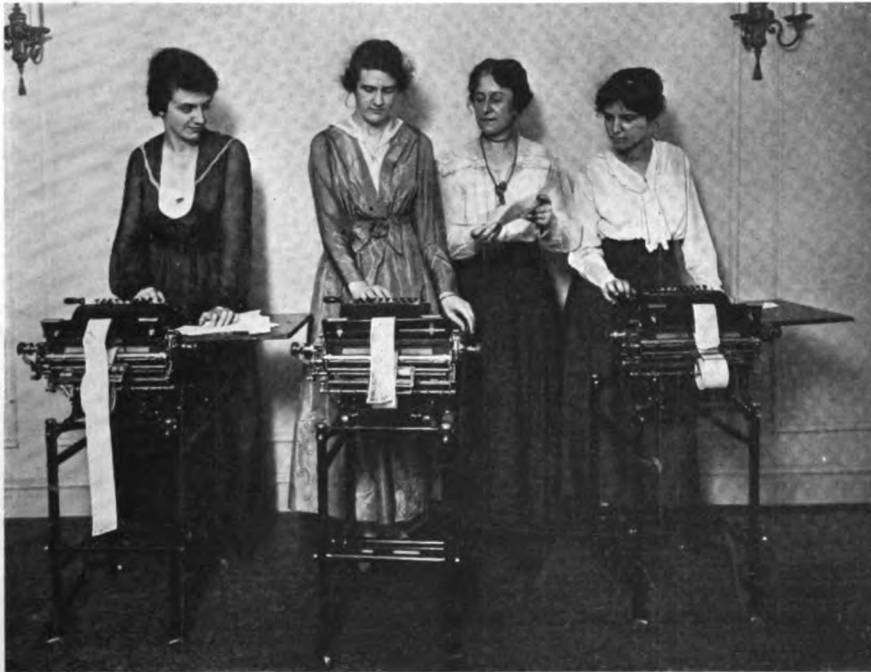

Photo by Paul Thompson

Group of young women receiving a demonstration in practical finance

certified checks; drafts, domestic and foreign; bank and commercial drafts, bills of exchange and acceptances; foreign money and exchange; cables; gold imports and exports; rediscounts; Federal Reserve Banks; clearing-houses.

While due care is taken to convey a general understanding of the underlying principles of banking, it is the especial aim to employ the practical methods of banking offices rather than to dwell on mere theories.

The useful nature of this training has already attracted the interest of leading

necessity, and preceding such a change it is desirable that the women who are to take the men's places should be carefully trained for their new duties. This training is being provided by the institution referred to, and it promises to be of important service in recruiting the ranks of those who are to carry on the future banking duties of the country.

BUSINESS TRAINING FOR WOMEN

As an adjunct to the banking course, women are being instructed in such

practical subjects as accounting, investing, the intricacies of the commercial markets, the management of various kinds of business undertakings, and domestic economy. How comprehensive the accountancy course is may be seen from the fact that it not only includes the various forms and books used, but comprises such subjects as bank and investment accounting, real estate, household, brokers and personal accounts, income tax, and general.

The investment course begins with a differentiation of investment and speculation, explains the methods of issuing stocks and bonds, and points out the relative standing of each from an investment standpoint and how their values may be judged. Methods of incorporating companies are explained and the meaning of the terms "common" and "preferred" shares, "cumulative" and "non-cumulative," etc., etc., made clear. The intricacies of the New York Stock Exchange and of the "curb" market are also revealed.

Managerial courses in the various branches of business help in qualifying women for service in practically every line of trade.

As a part of the regular course of instruction lectures are given on each subject by men prominent in banking, investments, real estate, business and commercial lines.

A group of successful business women have offered to give informal talks on "opportunities for women," the viewpoint to be given from their desk in the office.

PRACTICAL VALUE OF THE COURSE

Besides fitting women for better service as employees in banks and offices, this training is essentially valuable in making it easier for women to manage their own affairs—to know the ins and outs and the whys and wherefores of business dealings just as men do. Women who are employed all have incomes; and whether these be large or small, the prudent management of them is imperative. Moreover, at some time or other nearly every woman comes in

contact with business transactions on her own account, and it is the purpose of this course of instruction to give practical assistance to women in gaining an understanding of their rights and duties, so that they may act in such matters in the light of their own information. Here are only a few of the many situations in which women find themselves where training of the character outlined is bound to be beneficial—the handling of personal or household bank accounts; ownership of real estate or other property; money left to one's own use or in trust; home economics; investments in real estate, stocks or bonds; managing a business or engaging in business on one's own account; the woman who wishes to keep abreast of her husband in his business affairs, and to the woman who wishes to be equipped intelligently to discuss business and economic affairs.

In this somewhat ambitious programme, from which, however, one's own favorite specialty may be selected, the most important business for which women can fit themselves—household management—is not neglected. There is, on the contrary, full realization of the fact that it is just here that our economic life is weakest, and the course of instruction aims to correct this glaring deficiency by giving to women that practical insight into business affairs without which their attempts to regulate household economics are destined to failure.

As illustrating the estimation in which the work is held by large New York financial institutions it may be stated that graduates have been placed in responsible positions with the Bankers Trust, National City Bank, J. P. Morgan & Company, Federal Reserve Bank, National Bank of Commerce, and Chase National Bank.

Women as a rule have lacked both the scholastic training and the experience which would fit them for carrying on the practical affairs of business, and whatever tends to make good this deficiency constitutes a distinct gain to the economic welfare of the nation.

Export Engineering and Contracting

EVEN with the unsettled present day conditions and undiscernible future, the imperativeness and wisdom of planning now to have the United States permanently take its proper place among the exporting nations of the world is obvious. It necessarily interests every manufacturer who will want to keep up, in so far as is possible, the present high rate of production and sales after a return to normal business conditions. After the war it will be necessary to replace the present abnormal market with business obtained as the result of ability to compete with the nations who have developed and established their export business after years of painstaking study.

Experience with the overseas inquiries has generally been that while they are comprehensive, often indicating a desire to purchase the equipment for a complete plant, they are so vague that it is impossible to make up a satisfactory proposal, or owing to the difference in standards of operation, it is not possible to tell what equipment to supply, and there are usually not sufficient details to enable a manufacturer to propose suitable equipment. To make up quotations involves a great deal of work; there has been an enormous consumption of catalogues and descriptive literature and the business which has developed therefrom, in many cases, has not warranted the expense.

An organization which will be the necessary connecting link between manufacturers and the overseas buyer and consumer is primarily a specialized organization of experts and engineers prepared on one hand to study the requirements of the overseas buyer wherever he may be located, and by bridging up the gap caused by different languages, draw forth from prospective purchasers the details of their requirements from an engineering standpoint, and, on the other hand, such an organ-

ization which by training and experience and knowledge of American manufactures and methods can place these inquiries where they can be handled to the best advantage and with the elimination of unprofitable development work.

This organization must also be able to offer the same service in delivering American manufactures to overseas buyers as American manufacturers are able to offer in delivering their products to buyers in the United States, and this involves constantly being in touch with the methods of handling and packing for ocean shipment. The average American manufacturer is able to weed out from among the inquiries received from American buyers those which are probably unlikely producers of business, but when it comes to appraising the value of the average foreign inquiry, it requires an organization which is specialized and able to collect the necessary information from hundreds of different sources.

To provide information as to how to use these additional facilities for American exporters, so far as they apply to steel products, machinery and mechanical equipments, the American Steel Export Co. of New York has published an interesting and attractive booklet under the title of "Export Engineering and Contracting." This booklet will be published in numerous languages and is designed primarily to acquaint the foreign purchaser of mechanical equipment with the company's methods and facilities. To assist in weeding out from the mass of foreign inquiries those in which it appears that the chances of business materializing is remote or in which the units which they propose to install or the capacities which they have in mind are so small as to be either uninteresting or unprofitable to commercially operate, an Information Sheet in various languages has also been provided.

How Bankers Are Doing Their Bit

If any one of the officers of your bank have joined the colors, if you are making special provision for your employees who enlist, if you have started a Garden Club or a Liberty Loan Club or are engaging in any unusual activity incidental to the war, we hope that you will write us about it.

Our idea is simply to record in the *MAGAZINE* what banks and bankers are doing in the war so that our readers may know about their contemporaries in every part of the country and incidentally receive suggestions and inspiration of how they themselves may help in the big task that confronts us.

BANKERS in every part of the country are doing their bit, and more,—not only in giving their time and energy in floating the Liberty Loan, but in many other ways. Many officers have gone into the active service of the country in some branch of the army or navy. Many banks have started Garden Clubs, Pig Clubs, Calf Clubs, etc., and are using their influence in conserving and increasing the agricultural resources of the nation. Everywhere the bank has shown itself to be a great influence for good, even vying with the church in its power for community betterment. The war is teaching the nation many things, and not the least of these is that the banks, far from being soulless, cold blooded machines, are in reality doing more than their part in the unselfish and patriotic service of their countrymen.

Following is an account of what some banks have done and are doing in connection with the war:

THE GUARDIAN SAVINGS AND TRUST CO., CLEVELAND, OHIO

As soon as the Liberty Loan was announced, this bank inaugurated a Liberty Loan Club, which made it possible for subscribers to pay for their bonds in fifty weekly installments.

For the convenience of the subscribers, the bank furnished them with special coupon books, containing fifty coupons in duplicate. These coupons serve as receipts when payments are made and at the same time act as reminders for future payments. (\$1 a week for fifty weeks bought a \$50

bond; \$2 a week for fifty weeks bought a \$100 bond).

The Guardian was the first bank in Cleveland to establish the 50-weekly payment plan and it is also stated that it was the first in the country as well.

The Liberty Loan Club instantly became popular. It was generally ad-



Standing in line to join the Liberty Loan Club of the Guardian Trust and Savings Bank of Cleveland, Ohio

vertised in the papers, street cars, circulars, display windows and by speakers, who went from shop to shop, hall to hall, and explained this simple and easy method for purchasing Liberty Bonds. The idea was accepted enthusiastically and crowds soon began to fill the banking room. An accompanying photograph shows the crowds at the Liberty Loan counter. Every available space in the banking room was utilized; two extra counters were built in front of the officers' quarters and as many as twenty-one tellers were employed to

take subscriptions. Even with all this extra help it was impossible to write up the books for the people as rapidly as they came in and many were obliged to call for their books at a later date.

Over 28,000 individual subscriptions were received over the counter, which is said to be the largest number of individual subscriptions received by any bank in the United States.

The Government officials particularly emphasized the fact that they desired to reach the masses and to arouse the people to their tremendous responsibility, and the Federal Board has complimented the Guardian very highly upon its splendid work, coöperation and results achieved in the Liberty Loan campaign.

UNION BANK OF CANADA

When the history is written of the war period activities of Canadian banking institutions, a notable chapter will be contributed by the Union Bank of Canada, whose New York Agency is

at 49 Wall Street. Every monetary function of the chartered banks of Canada has been employed in financing the war burden. The Union Bank of Canada, like all Dominion institutions, has done its quota in the granting of im-



LIEUT.-COLONEL SIR WILLIAM PRICE
Honorary President Union Bank of Canada



MAJOR-GENERAL SIR JOHN W. CARSON, C.B.,
A director of the Union Bank of Canada

pressive Imperial credits in the active coöperation with the Finance Minister, toward the fullest prosecution of the war, and in proportionate participation in domestic war loans, toward whose success the banks helped so materially.

Remarkable as have been the war time energies of Canadian banks from the viewpoint of finance, there is an equal—one may reasonably say greater—interest in the contribution of manhood to the cause. The Union Bank of Canada has an Honor Roll made up of 715 names. That is to say, since the outbreak of war, 715 officers have vol-

unteered for active service. Of these, up to the present, 55 have been killed in action, 38 are wounded or missing.

With such a drastic depletion of the male staff as has resulted from the enlistment of bank officers for overseas military service, a somewhat amazing change has been wrought in the personnel of the staff. At the outbreak of war, apart from the women acting in the capacity of stenographers, there was not a woman employed. The Union Bank of Canada's present staff consists of 1,575 members in 310 branches, of whom 427 are women.

Signal distinction has come to the Union Bank of Canada through two members of the Board of Directors assuming higher-up military commands. Lieut.-Col. Sir William Price, Honorary President, and Maj.-Gen. Sir John Carson, C.B., of Montreal, a director, have both achieved military prominence. Major Hume Blake, Toronto, is also a director. Sir William Price and Sir John Carson were among a distinguished party of Canadian bankers who officially visited the New York Agency of the Union Bank during July.

King George conferred a knighthood upon Maj.-Gen. Sir John W. Carson, C.B., in recognition of special services. Sir John went to England from Canada

almost immediately following the outbreak of war. He was the special representative of the Minister of Militia in London until a short time ago, when he returned to Montreal after being honored by his Sovereign. Sir John's military record dates back to 1891, when he joined the Fifth Royal Highlanders in Montreal, as a Second Lieutenant. His interest in the Canadian militia never waned. When he went overseas in 1914 he held rank as Lieutenant-Colonel. He was promoted temporary Brigadier-General in May, 1915, temporary Major-General in September, 1915, and Major-General in December, 1916.

Lieut.-Col. Sir William Price was chosen at the opening of the war by the Minister of Militia to open and organize Valcartier Camp, the training ground of the First Canadian Contingent, whose fame in this war is far-flung. Sir William's military interests began in 1886, when as Second Lieutenant he joined the Eighth Royal Rifles, retiring after five years. But with the outbreak of the Boer war he rejoined his old regiment, and raised two new companies. Following his success in aiding the quick dispatch of the First Canadians to England in the autumn of 1914, Sir William devoted

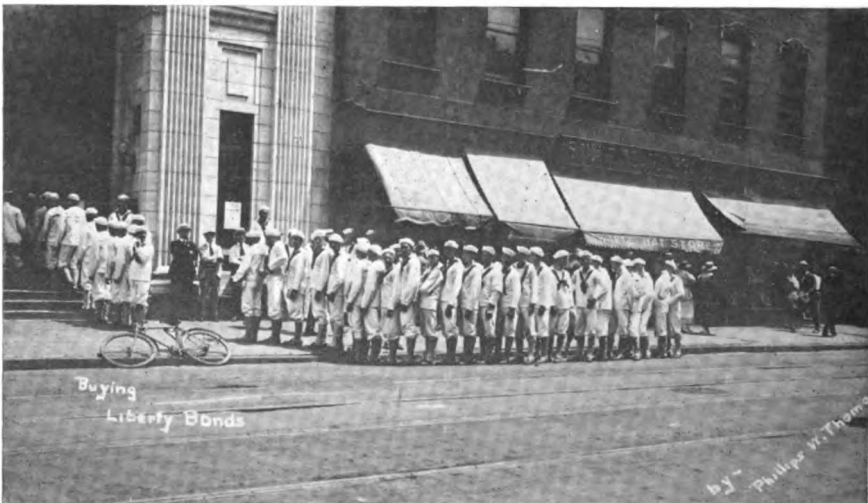

Sailors in line waiting to subscribe to the Liberty Loan at the Norfolk National Bank, Norfolk, Va.

his energies to recruiting. In December, 1915, he undertook a recruiting tour to the lower part of the Province of Quebec, later offering to raise a regiment. This offer being accepted by the military authorities, the battalion was duly raised, and Sir William in command left with his men in November, 1916, for overseas. On his arrival in England this regiment, the 171st, was broken up. Sir William stepped down from his command and went to the front with a railway battalion, having rank as Captain. At the front he earned his promotion, once more becoming Lieutenant-Colonel, and attached to the Fourth Canadian Division. Sir William later returned to Canada, and, since, has been giving his attention to his very extensive lumbering business in North-east Quebec.

CLEVELAND TRUST COMPANY, CLEVELAND, OHIO

"You," the monthly publication of the Cleveland Trust Company, takes patriotism as its keynote these days. In its May issue it announces nine employees as being in active military or naval service.

One of the company's directors, Fayette Brown, is captain in Troop K, Ohio Cavalry.

MERCHANTS' BANK OF CANADA, MONTREAL

American bankers must go far to equal the splendid record of their Canadian contemporaries whose heroic sacrifices and unselfish service will never be forgotten. Here is what one bank has done:

When the war started, says the General Manager, we had 874 men on our staff of military age (though not necessarily physically fit). Up to date 516 have enlisted for Overseas Service, half of whom have been replaced temporarily by female clerks and the balance by young juniors and middle grade clerks, many of whom are unfit for military service. Those of our officers who first enlisted were continued on our salary

NO one WANTS to be a Slacker

DO YOU know what a "curtain of fire" is? It is when the enemy brings up thousands of pieces of artillery, great cannon firing shells as large as a man's body, one of which exploding among five hundred men could kill them all—other smaller guns firing shrapnel, with millions of bullets scarcely less destructive—hundreds of thousands of shells, all exploding along a certain line, until there is a real wall of explosion, a wall of death to be passed.

And our boys are going in—in where they use curtains of fire as you use matches—going in with high hearts and a laugh—and OUR boys will go THROUGH—some of them.

Brother, you can't go with them. You are too old, or you have too many dependent on you, or you can't pass the examination, or you are needed in your present work to keep the wheels of business moving at home.

IRVING NATIONAL BANK WOLWORTH BUILDING NEW YORK

The Irving National Bank of New York was among the most effective advertisers of the Liberty Loan

list on the basis of half pay for periods varying according to the length of their service, which arrangement was in force for about a year and a half, following the declaration of war.

CITIZENS COMMERCIAL TRUST CO., BUFFALO, N. Y.

This bank is operating a Liberty War Loan Club, and in one week enrolled close to 5,000 members.

Every effort was made to bring this plan of purchasing Government Bonds before the public. The same was advertised in the street cars, newspapers, motion picture houses, and by means of the distribution of descriptive cir-

What Our Job, Don't We? You don't want to be a slacker... You don't want to be a slacker... You don't want to be a slacker...

How to Do It. If you have a bank account go to your bank and subscribe... If you have no bank account go to your bank and subscribe...

What We'll Do. In a day or two days or three days you'll be well begun to subscribe... And you need American with the staff in bank that is...

What We'll Do. In a day or two days or three days you'll be well begun to subscribe... And you need American with the staff in bank that is...

What We'll Do. In a day or two days or three days you'll be well begun to subscribe... And you need American with the staff in bank that is...

What We'll Do. In a day or two days or three days you'll be well begun to subscribe... And you need American with the staff in bank that is...

What We'll Do. In a day or two days or three days you'll be well begun to subscribe... And you need American with the staff in bank that is...

What We'll Do. In a day or two days or three days you'll be well begun to subscribe... And you need American with the staff in bank that is...

What We'll Do. In a day or two days or three days you'll be well begun to subscribe... And you need American with the staff in bank that is...

What We'll Do. In a day or two days or three days you'll be well begun to subscribe... And you need American with the staff in bank that is...

culars from house to house and throughout the office buildings.

Under this plan a person can purchase a Liberty Bond by making fifty weekly payments. No charge is made by the bank for purchasing and carrying the bonds.

FIRST NATIONAL BANK, BERWICK, PENN.

The following laconic message received from this bank speaks for itself and is typical of what banks are doing in every part of the country:

Two of our employees are registered for the draft.

Our assistant cashier is deeply interested in Red Cross subscriptions.

Our Liberty Loan Club is a success.

Our officers have given use of vacant lots for gardening.

We are on the map and busy.

BANKERS TRUST COMPANY, NEW YORK

"No slackers here" is the slogan of the Bankers Trust Company from the president to the youngest page. Even before the declaration of war, the company had representation at the front among the ambulance drivers, and losses in the various departments through enlistments have been the daily routine during recent weeks. Up to the present, members of the Bankers Trust Company force are serving in France in the ambulance work and in the Flying Corps, and at home in the Naval Reserve, the Navy Paymaster's Department, the Reserve Officers Corps, and the regular army, upwards of twenty-five men having enlisted in these various divisions. To fill the places thus made vacant, young women have been engaged very largely, who in turn are doing double service by joining in the work of the Red Cross. A unit has been organized among the employees of the trust company, which meets one evening a week for making surgical dressings, relief outfits, etc.

In the strenuous work connected with the Liberty Loan, the Bankers Trust Company took a prominent part. Sew-

ard Prosser, the president of the trust company, was called upon to assist in the organization work, and during the campaign gave up practically his entire time to this important undertaking. Men and women were drafted from the various departments of the company to help in the work of the committee, and the facilities of the company were placed freely at the disposal of the public in receiving subscriptions to the bonds. While amusing incidents have been reported in connection with Liberty Bond subscriptions, an occur-



Battery C Field Artillery, First Regiment, N. G. N.
J. P. H. Dolson of the trust department of the
Bankers Trust Company, New York, is
shown in this picture

rence in the Bankers Trust Company gave the special officers some brief moments of anxiety and later furnished the window man with considerable amusement. Boxes and closely-wrapped packages in the hands of visitors are viewed with distrust these days in Wall Street, and when a woman walked up the steps of the Bankers Trust Company one morning and entered the rotunda with a suspicious-looking package, the special officers followed closely, ready for prompt action. However, she marched quietly up to a window, which bore the inscription "Liberty Bond Subscriptions Received Here," and called for an application blank. After filling this out, she passed it through the window, at the same time shoving her package over to the astonished clerk. Undoing the wrappings



Patriotic femininity of the First National and First Trust and Savings Banks of Chicago at the Liberty Bond Window of the latter

gingerly, he uttered an exclamation of surprise to find before him a shoe box filled to the top with Buffalo nickles—1,400 of them—which this painstaking woman had collected and saved for a rainy day.

When the Red Cross campaign to raise \$100,000,000 was announced, it was no surprise to New Yorkers to hear that the President of the Bankers Trust Company, Seward Prosser, had been chosen as chairman of the executive committee. The "punch" and enthusiasm characterizing the Red Cross membership campaign in 1916, which was directed by Mr. Prosser, proved his fitness for the new task, and assured its success at the outset. Notwithstanding the fact that Mr. Prosser had been absent from his office almost continuously for two weeks in the Liberty Loan campaign, he once more dismissed his regular business and responded to the new call from his country with vigor, and for two weeks more labored continuously from early morning far into the night directing the work, which has brought such magnificent results. Naturally Mr. Prosser used as aids in many instances the organization with which he is associated in business, and therefore the directors, officers and employees of the Bankers Trust Company were called upon to shoulder a great part of the tremendous detail attached to this project. It was no unusual ex-

perience during this drive for members of the Bankers Trust Company force to hurry to the Red Cross office after their routine duties for the day were completed and there labor frequently until the morning hours, but glad of the opportunity of participating in this worthy cause. Their further practical interest was shown by the subscription of \$1,000 turned in exclusively from employees of the Trust Company.

AMERICAN STEEL EXPORT COMPANY,
NEW YORK

Among those in the service of the American Steel Export Company, New York, who have been called to the colors is K. G. Martin, manager of the service and publicity departments. Mr.



K. C. MARTIN

Manager of the Service and Publicity Departments of the American Export Steel Company, who has received a Commission as Captain in the Officers' Reserve Corps, Motor Transport Service

Martin was granted an honorable discharge from the Twenty-second Regiment, Corps of Engineers, N. G. N. Y., in order to be able to accept a commission as captain, Officers' Reserve Corps, Motor Transport Service. His mem-

bership in the American Society of Mechanical Engineers, American Institute of Electrical Engineering, National Electric Light Association, Society of Automobile Engineers, New York Electrical Society and American Museum of Safety, indicates his wide acquaintanceship with engineering practice and the knowledge he will be able to bring to bear on military problems.

LAKE COUNTY NATIONAL BANK,
MADISON, S. D.

Thomas A. Wadden, Harvard Law, 1916, and vice-president of this institution, has joined the First Minnesota Infantry.

Mr. Guernsey conducted an active publicity campaign, explaining the inducements Uncle Sam offers to applicants, and as a consequence, interested quite a number of Stocktonians, who are in training at the Presidio, San Francisco.

THE MICHIGAN TRUST CO., GRAND
RAPIDS, MICH.

Secretary John H. Schouten is a major in the Thirty-second Regiment of Michigan National Guards.

DOLLAR SAVINGS & TRUST CO., WHEELING,
W. VA.

Among other things this bank purchased 10,000 copies of national songs for distribution in the community.

On July 4 a special dividend of \$20,000 in Liberty Bonds was paid to stockholders of record June 20. In cases where the dividend was not large enough to at least buy a \$50 bond, the stockholder was urged to make up the difference so as to buy at least one bond.

The bank also offered to take care without charge of the financial affairs of all enlisted men in the army or navy. This included the services of its safe deposit department.

To all its employees who enlist the bank offers to hold their position open until the war is over and to pay their full salary, less what the Government gives them.

STATE BANKING DEPARTMENT OF
WISCONSIN

One of the examiners of this department, J. H. Coe, is now at the officers' training camp at Fort Sheridan, Ill. Mr. Coe is an "old soldier," having enlisted last July for the Mexican war. He was at the border from July until the latter part of December of last year, and returned to his work in the State Banking Department the forepart of January, 1917, his position having been kept open for him. Of course, as soon as the trouble arose with Ger-



**To Our Friends and
Their Friends**

We have offered our Facilities and Services to the Local Chapter of the American Red Cross. Many of us think of the Red Cross as only a war organization. Still, you know what the Red Cross has done right here in Lake County. You know what it did in the Ohio floods and the San Francisco fire. You know what it has done and done wherever men, women and children suffer.

Whenever there is human need the Red Cross has gone to the front and kept there. Each one of us knows that the demands on the Red Cross are going to grow greater every day from now on until the end of the war. Not only must the Red Cross continue to work at the front and in the hospital, but it must be kept organized to meet the emergencies which these times of conflict.

Remember the work of the American Red Cross is particularly for American soldiers. The President of the United States has ordered that its services be extended by the War Department. Its flag is recognized on every battlefield.

The big thought for us all is that by joining the Red Cross we can do something and do it now and do it for the benefit of our own countrymen.

You can get a membership in the Red Cross in amounts from one dollar to one hundred dollars. The best membership, if you don't feel able to subscribe for a larger amount, is the \$2.00 one, for with that you get the Red Cross Magazine and by it are kept advised of the work your organization is doing. You'll be glad to see what a wonderful good year \$2 is helping to provide.

We are glad to make this opportunity to all every man, woman, boy and girl who sees this advertisement to become a Red Cross member and to secure at least one other member.

Lake County National Bank

Banks everywhere have generously devoted their advertising space to arousing the patriotic spirit of the public

FARMERS AND MERCHANTS BANK,
STOCKTON, CAL.

Frank A. Guernsey, president of the Farmers and Merchants Bank, is doing important work for the government, having been appointed chairman of the local committee named to pass upon applications for the officers' reserve.

many, he was one of the first to be called to Fort Sheridan.

THE ATLANTIC NATIONAL BANK OF JACKSONVILLE, FLA.

Many of the employees of this bank have already enlisted. In fact, so many that the officers have not yet become acquainted with the new men who have filled their places.

The directors recently passed a resolution, authorizing the officers to pay to certain employees who enlisted the difference between the net salary that they earned at the bank and the net income they would receive from the United States Government.

This bank sent in subscriptions aggregating \$825,000 to the Liberty Loan bonds, which was the largest subscription sent in by any bank in the State by \$225,000.

CENTRAL MANUFACTURING DISTRICT BANK, CHICAGO

There was subscribed for by and through this bank to the Liberty Loan bonds a total of \$355,000. The bank numbers among its subscribers approximately 3,200 people, ninety-five per cent. of whom purchased \$50 and \$100 bonds on the partial payment plan, who never before have owned bonds or stocks.

THE NEGAUNEE NATIONAL BANK, NEGAUNEE, MICH.

This bank sent out the following circular letter urging greater food production:

The need of more food production throughout our nation was never greater than in this year.

This country is now at war. Imagine what conditions will be next winter, and the effect upon all industry, if food products are scarcer and higher in price than they are now.

Neither regulation of prices nor increased wages can add a single bushel of wheat, potatoes or other life necessities, to our supplies.

There are many idle acres in this community and many nonproductive lots in our city. There is yet time to put them under the plow and spading and make them add to the production and wealth of our people.

Every loyal American citizen in good health can serve his country.

And to those who till the soil will come the benefits. Prices will not be lower; the producer must profit.



Corn Exchange National Bank, Philadelphia, Pa., decorated for the Liberty Loan campaign

THIS BANK WILL LEND EVERY POSSIBLE ASSISTANCE to help this community to increase the food production.

THE NATIONAL STOCK YARDS NATIONAL BANK, NATIONAL STOCK YARDS, ILL.

Four of the employees of this bank are in service and ten of the remaining force are registered.

The bank applied for \$300,000 in Liberty Bonds, mostly for its customers, the proposition being to loan them the money at three and one-half per cent. for a term of six months.

THE LUMBERMAN'S NATIONAL BANK, MENOMINEE, MICH.

Every officer and director of this bank, and every employee, is a member of the Red Cross, and has bought a Liberty Bond.

One of the directors, Wm. S. Carpenter, is at the officers' training camp at Fort Sheridan, Ill. Another director, A. C. Wells, has offered himself, together with his yacht, "Isabella," and if accepted is holding himself ready to enter the service at once.

Cashier William Webb Harmon is chairman of the Liberty Loan Committee, which conducted a very vigorous campaign of the sale of bonds, as a result of which the city over-subscribed its allotment to the extent of \$50,000.

Mr. Harmon was also a member of

the committee having the Red Cross campaign in charge.

HENDERSON NATIONAL BANK, HENDERSON, KY.

Robert B. Posey of this bank has joined the Machine Gun Company, Third Kentucky Infantry, now stationed at Lexington.

W. E. Gregory, who came to the bank about eighteen months ago, has returned to his mother's farm, expecting to make the farm produce its maximum food products.

Messrs. L. L. McAvoy, Richard J. Crawford and Henry P. Vogel, have registered under the conscription law.

This bank has sold to 249 customers \$98,700 of Liberty Loan bonds.

THE FIRST NATIONAL BANK OF RACINE, WIS.

G. N. Fratt, vice-president of this bank, says:

"Banks here are doing their share in regard to the Liberty Loan and other matters in that connection. We had a big campaign here and our quota was oversubscribed about half a million dollars. We worked up a large fund for the Red Cross, meeting with great success. Four of the employees of this bank are members of our battery and left on July 2 for camp and expect to be gone at least eight months, and no

telling when they will come back. We have two batteries here in Racine. The garden clubs are working to their fullest capacity."

WOODLAWN TRUST AND SAVINGS BANK, CHICAGO, ILL.

This bank reports as follows:

"We made the Liberty Loan the chief feature of the May-June issue of our 'Woodlawn Bank Notes.' Subscriptions to the loan through and by us were ten per cent. of our deposits.

"We have started a Liberty Loan Club.

"We have subscribed to the Red Cross.

"We had three men subject to draft registration; one, our president's son, Walter S. Poague, is in camp at Winthrop, Maryland, as second lieutenant U. S. Marine Corps; a second is with Chicago University Ambulance Unit No. 3; the third will leave soon for training. A younger boy left us earlier and joined the navy; he has already paid his debt to his country by dying in the service."

ILLINOIS TRUST AND SAVINGS BANK OF CHAMPAIGN, CHAMPAIGN, ILL.

Up to the present date two of the staff of this bank have joined the colors, F. Way Woody, the cashier, having entered the Officers' Reserve Corps at Fort Sheridan, and S. R. Sill enlisted in the Ambulance Corps of the regular army.

The bank put forth every effort towards disposing of the Liberty Bonds. Aside from purchasing a large block itself, the bank adopted such an easy payment plan as to enable a large number of our small depositors and townspeople to buy bonds. V. W. Johnston, the president, was an active member of the committee appointed to bring Champaign County's subscription up to the \$1,000,000 mark set by the Federal Reserve Bank. The success of the committee may be judged by the total amount subscribed exceeding the amount set by \$100,000.



West Newton Savings Bank, West Newton, Mass., during the Liberty Loan campaign

New Superintendent New York State Banking Department

AFTER three years' service the term of Hon. Eugene Lamb Richards as Superintendent of the Banking Department expired on July 1, and Hon. George I. Skinner, First Deputy Superintendent, was appointed as his successor.

Mr. Skinner has had twenty years' continuous service in the State Banking Department, during fourteen of which he was First Deputy Superintendent of Banks, and his promotion was made by Governor Whitman at the practically unanimous request of the state institutions.

Mr. Skinner has made a success of life by his own ability and character, his father having died during his infancy. He was born in Sherburne, Chenango county, New York, February 20, 1858, being the son of Dan Barnes and Jennet (Horton) Skinner. He graduated with honors from Colgate Academy in 1876 and from Madison University (now Colgate) in 1880. On November 19, 1890, he married at Smithville, N. Y., Mary Elizabeth McCrea. They have four children, George McCrea, Elizabeth M., Laura Ione and Margaret Irene.

After leaving college Mr. Skinner was assistant superintendent of schools at Norwich, N. Y., from 1880 to 1882, and from 1882 to 1885 he was the principal of the Smithville Union School. In 1887 he was admitted to the bar at Syracuse and practiced his profession at Bainbridge for ten years, during which time he also served as postmaster of that village. His first connection with the Banking Department was in January, 1897, when he was appointed Bank Examiner. The same year he was made chief of the foreign mortgage and building and loan association bureau in the department. He was appointed Second Deputy Superintendent

of Banks in 1902 and in January, 1903, he was appointed First Deputy Superintendent, which office he has since filled continuously. Although a Republican, he held this office under two Democratic officials, former Superintendent George C. Van Tuyl, Jr., and



HON. GEORGE I. SKINNER
Superintendent New York State Banking Department

the outgoing Superintendent, Eugene Lamb Richards. He acted as Superintendent for three and one-half months after Superintendent Charles H. Keep resigned to become a public service commissioner in 1907.

Mr. Skinner has given special attention to the work of savings and loan associations, and is a recognized authority on all subjects relating to them.

Governor Glynn appointed Mr. Skinner a delegate to represent the state at the second national conference on currency reform under the auspices of the New York Academy of Political Associations, held in New York, October 12, 1913.

In 1907, when the panic came upon the country, Mr. Skinner as acting superintendent took charge of the financial situation in the state, in so far as state institutions were affected, and his efforts were influential in averting a more serious crisis.

When the New York State Legislature passed a law creating a commission to revise the banking laws, Mr. Skinner, on account of his long connection with the department, and his recognized experience in handling intricate banking problems which developed during the years of his deputyship, was the natural selection as a

leading counsel to the commission named to have charge of this work. Under leave of absence as First Deputy Superintendent of Banks, Mr. Skinner gave several months of his time to this work.

Headquarters for the commission were established in the rooms of the New York Chamber of Commerce and there Mr. Skinner gave numerous hearings on suggestions made by interested parties and worked indefatigably to adapt the law to business conditions and to the needs of the banking community. The language of the law, up to that time, had been full of ambiguities, but the new law has served as a model of banking law revision for several important states in the Union. Mr. Skinner's distinguished services to the state in the revision of the banking law will always stand as a monument to his fine legal and banking qualities.

Patriotic Views of an American of German Birth

By OTTO H. KAHN

A CENTURY and a half ago Americans of English birth rose to free this country from the oppression of the rulers of England. To-day Americans of German birth are called upon to rise, together with their fellow-citizens of all races, to free not only this country but the whole world from the oppression of the rulers of Germany, an oppression far less capable of being endured and of far graver portent.

Speaking as one born of German parents, I do not hesitate to state it as my deep conviction that the greatest service which men of German birth or antecedents can render to the country of

their origin is to proclaim, and to stand up for those great and fine ideals and national qualities and traditions which they inherited from their ancestors, and to set their faces like flint against the monstrous doctrines and acts of a rulership which have robbed them of the Germany which they loved and in which they took just pride, the Germany which had the good will, respect and admiration of the entire world.

I do not hesitate to state it as my solemn conviction that the more unmistakably and wholeheartedly Americans of German origin throw themselves into the struggle which this country

has entered in order to rescue Germany, no less than America and the rest of the world from those sinister forces that are, in President Wilson's language, the enemy of all mankind, the better they protect and serve the repute of the old German name and the true advantage of the German people.

Gentlemen, I measure my words. They are borne out all too emphatically by the hideous eloquence of deeds which have appalled the conscience of the civilized world. They are borne out by numberless expressions, written and spoken, of German professors employed by the State to teach its youth.

The burden of that teaching is that might makes right, and that the German nation has been chosen to exercise morally, mentally and actually, the over-lordship of the world and must and will accomplish that task and that destiny whatever the cost in bloodshed, misery and ruin.

The spirit of that teaching, in its intolerance, its mixture of sanctimoniousness and covetousness and its self-righteous assumption of a world-improving mission, is closely akin to the spirit from which were bred the religious wars of the past through the long and dark years when Protestants and Catholics killed one another and devastated Europe.

I speak in sorrow, for I am speaking of the country of my origin and I have not forgotten what I owe to it.

I speak in bitter disappointment, for I am thinking of the Germany of former days, the Germany which has contributed its full share to the store of the world's imperishable assets and which, in not a few fields of human endeavor and achievement, held the leading place among the nations of the earth.

And I speak in the firm faith that, after its people shall have shaken off and made atonement for the dreadful spell which an evil fate has cast upon them, that former Germany is bound to arise again and, in due course of time, will again deserve and attain the goodwill and the high respect of the world

and the affectionate loyalty of all those of German blood in foreign lands.

But I know that neither Germany nor this country nor the rest of the world can return to happiness and peace and fruitful labor until it shall have been made manifest, bitterly and unmistakably manifest, to the rulers who



OTTO H. KAHN

bear the blood-guilt for this wanton war and to their misinformed and misguided peoples, that the spirit which unchained it cannot prevail, that the hateful doctrines and methods in pursuance of which and in compliance with which it is conducted are rejected with abhorrence by the civilized world, and that the over-weening ambitions which

it was meant to serve can never be achieved.

The fight for civilization which we all fondly believed had been won many

years ago must be fought over again. In this sacred struggle it is now our privilege to take no mean part, and our glory to bring sacrifices.



Commercial Borrowers Can Create Liquid Banking Position

IF commercial borrowers would arrange to have their notes mature not more than three months from the date of issue," says James S. Alexander, president of the National Bank of Commerce in New York, "not only would the banking condition become more liquid, but a broader and more stable open market for the commercial paper itself would be assured.

"Current rates for money have advanced materially from the levels prevailing earlier in this month and considerable attention is being given to the new rates from day to day. The question has been raised as to whether there will be enough money available during the next few months to conduct both the gigantic war enterprises being made necessary by the requirements of our government and those of our allies, and also our current commercial needs. This question is particularly pertinent because it is believed that the government will find it necessary within a short time to make another offering of bonds.

"The movement of crops in the season now approaching will impose additional burdens on the money market. Then, too, an unusually large use of credit facilities is required while commodities continue to maintain their present high price level.

"This nation now looks to its Federal Reserve Banks to provide additional credits and circulating notes when the occasion requires. In this way, interest rates are kept within bounds and the money market is kept in funds. Under the Federal Reserve Act, these re-

sources of the Federal Reserve Banks may be made available on a large scale only in the following ways:

- "1. Purchase of acceptances by the Federal Reserve Banks.
- "2. Loans to member banks for not more than ninety days secured by obligations of the United States Government.
- "3. Rediscounts of commercial paper having not more than ninety days to run.
- "4. Loans for not more than fifteen days secured by United States Government bonds or certificates of indebtedness or by commercial paper maturing within ninety days.

"We may safely assume that the resources of the Federal Reserve Banks are ample to meet any conditions that may arise. The paramount question is whether the amount of available, eligible commercial paper and government bonds held by the member banks is sufficient to establish such additional credits as may be required with the Federal Reserve Banks through the process of loans and rediscounts. It is a well established practice for the makers of commercial paper to issue notes payable six months after date. These six months' notes are negotiated either in the open market through commercial paper brokers, or directly with the maker's bank of deposit. These six months' notes are not available for rediscount until three months after the date of issue.

"If these notes were payable ninety days from date, they would at once be available for rediscount with any Federal Reserve Bank. If the suggestion were made by banks and brokers and adopted by their customers that commercial borrowers make their notes for ninety days instead of six months, a more liquid banking position would soon result."

Banking Publicity

AUGUST 1917

Building a Bank Advertisement*

By EDWIN BIRD WILSON

BANK advertisements worthy of the name are built rather than written; they are constructed after a definite plan first conceived in the mind of some architect of advertising.

Architects are limited in their creations by the amount of money available, the size of the plot, the requirements of the building, etc. Happy is the architect who receives this kind of a commission: "Build me a house on as much ground as you need, at any cost within reason, to accommodate my family and provide entertainment for my friends." Once to the architect, in a lifetime, perhaps, comes such a commission. The rule is: "Build me a house on a lot such a size, with so many rooms, to cost not more than so much."

In handling the accounts of various clients, I am strongly impressed with the importance of learning the facts, obtaining good material out of which to build advertisements. Some financial institutions are full of interesting facts about what they do and how they do it. It is easy to discover the strong points of their personality and the arguments

for doing business with them. Others at first glance seem lacking in strong advertisable characteristics, but by digging deeply enough, by questioning the officers and clerks, by talking with customers, we find that there are good, interesting reasons for doing business with them. Placer mining will not do in such cases; you've got to dig and sometimes even sink a shaft in order to discover the right kind of material.

What a pleasure it is to find officers of financial institutions who will coöperate fully in the development of material; one, for example, who will give you such definite facts as these: "In the first place, our officers are all accessible and open to the public. They are all easily approached, and clients do not have to wait hat in hand, behind closed doors.

"We have the finest banking location in the city, because it is in the midst of the shopping district, in the midst of the legal fraternity, one square from the courthouse, three squares from the city hall, two squares from the postoffice, in the centre of the financial district and at the intersection of the four principal car lines.

"Our income tax department last year served over

1,000 clients. This service is absolutely free. We answer intricate questions, keep abreast of all the rulings, compile proper certificates, and have actually compiled reports for hundreds of individuals and corporations.

"We have a women's department with a woman attendant, telephone service, writing desks, etc. This is the most popular rendezvous for women in the city, and serves the finest clientele. Women particularly appreciate our sunshiny, pleasant rooms, and the promptness and cordiality with which our clerks handle their business.

"Our publicity department has lately issued twelve booklets on the subject of the new tax laws, trust laws, etc. We try to put this information into the hands of our customers and anyone else who wants it, just as soon as possible. Our whole endeavor has been to get people to come into our banking rooms, knowing if they once transact business with us, they would want to remain as our clients."

Having developed the raw material, knowing what we have to build our advertisements out of, we should plan as definitely as the architect plans a house. Given the same material, the uncultured workman will build an ugly hut, the master architect will build an edifice

(Continued on page 2)

*An address before the financial advertisers departmental at the St. Louis Convention of Associated Advertising Clubs of the World

Banking Publicity

Monthly Publicity Section

THE BANKERS MAGAZINE

253 Broadway, New York

AUGUST 1917

BANK advertisers will be interested in the announcement of the publication of a new book on bank advertising, "The New Business Department," by T. D. MacGregor, another volume in the Bank Department Series published by the Bankers Publishing Company of New York.

This book describes the organization and operation of a bank department created for the avowed purpose of getting new business for the bank and systematically cultivating old business and making it more profitable.

In the old days of little competition, banks did not pay much heed to this phase of banking. They had plenty of profitable accounts and there was no enterprising neighbor whose progressive methods were likely to draw them away. Business just naturally came to the banks and there was no need for the banks going out for business.

But conditions have changed. The prospective customer with a bank account to place funds, in every enterprising city, that he has considerable choice as to where to place this account. There are several banks and all are eager for his business. The bank to get the account is the one which has the most to offer in the way of service and "reasons why."

This is where the New Business Department comes in. Its function is to get accounts and to keep them and make them profitable. Its members are the intensive farmers of banking. They cultivate a rich but restricted area and the fullness of the crops is the criterion of their skill.

The operation of this department has been worked out by many banks in a most scientific manner. Its carefully kept records give important and detailed information about every account, present or prospective. Its influence is felt in many and varied ways.

Nor are these departments confined to the larger banks in the larger cities.

Many country banks have organized their new business efforts in a most effective manner.

One country bank, for example, keeps a card record of all of the farmers in its community, giving such information as size of farm, kind of crops, wife's maiden name, names of children, favorite topic of conversation. By an intelligent use of these records a bank officer can ingratiate himself with the farmer and gain his friendly confidence and incidentally his business.

A reading of "The New Business Department" will offer to bankers many suggestions as to how to organize and co-ordinate their publicity efforts.

Building a Bank Advertisement

(Continued from page 1)

of beauty. Don't botch our advertisements, spoiling good material. Let's build them into worthy structures. Mix skill and good taste and knowledge of the human mind with our facts.

Financial advertising, it seems to me, should set a high standard in this respect. We are dealing in high-class goods—credits, investments, exchanges—the very foundation and framework on which all other business is built. I am not going to cite concrete examples of how good material has been spoiled by bungling workmanship and bad planning. You all know how often the kitchen is placed where the drawing-room should be, how often a tumbledown shack of an "ad" is built out of materials which would, un-

der proper treatment, form a beautiful, interesting advertisement. An advertisement that doesn't look right isn't right. As the French chef said: "If the cake looks not well it tastes not well."

Keep always in mind what our advertisement is—our representative—and treat it with respect. Don't allow it to be called an "ad." We would not have a personal representative before the public who is careless in manners, personal appearance or speech. Our salesman must be a clean-cut, forceful fellow of winning personality. Our advertisements should be of like character. They meet and influence thousands of persons where our individual representative can reach only a few. Let us

put pure English words of truth into our advertisements and dress them in conformity with good taste. Let us give them a winning personality before sending them out to represent us.

Bring to bear upon our advertising problems all of the experience and ability we can summon to our assistance. Let us remember that one-man copy is likely to be narrow, one-sided copy. Coöperative effort of persons who understand the particular problems and who know what constitutes good advertising are necessary to produce the best advertisements. There is such a thing as working so close to our task that we cannot see its true proportions and an outsider's slant on the problem is usually helpful. Even our wives, who are supposed to know nothing about advertising, frequently can offer a criticism which will make our carefully planned advertisement seem inconsequential. You know the best of architects often have to bow to the ideas suggested by the lady of the new house.

An unusual example of coöperation in the preparation of advertisements was seen recently in New York. The Liberty Loan Committees of the American Bankers Association decided that they could render a service by sending to bankers throughout the country definite suggestions as to how they might advertise Liberty Bonds locally. So they called a few of us together one afternoon and said "We want at least a dozen good advertisements by to-morrow morning at 11

o'clock." Each advertising man present agreed to bring at least two advertisements by that hour. The "Copy Loan" was over-subscribed, and instead of a dozen there were available two dozen good advertisements. A sub-committee then selected and edited a dozen advertisements and within forty-eight hours broadsides showing proofs were in the mails on their way to 29,000 banks.

It seems hardly necessary in a departmental meeting of the Associated Advertising Clubs of the World to suggest that we advertising architects and craftsmen, particularly we of the financial advertising fraternity, should approach our work with a sense of our responsibility to the public. Remember that the people are going to believe at least a part of what we say and we don't want to have on our conscience the knowledge of having misled them. We men here present wield a tremendous power through our published messages to the public. We can create real confidence in reliable institutions and investments, or we can foster false confidence by betrayal of our trust and reap the following whirlwind of distrust and disaster.

At the present time we have great opportunities for public service. Some will consider it their duty to enlist, others will be drafted under our splendid, democratic plan for raising a great and efficient army. Others will serve in the home defense, but all of us will consider it a great privilege to serve in our

own profession and help to provide the sinews of war and foster a feeling of devoted patriotism. It is conceivable that each of us may, by means of our skill as advertising architects and craftsmen, multiply many fold our individual fighting strength, may exert an influence for democracy which will far outweigh anything we could do as individual soldiers on the firing line. The advertising fraternity of Great Britain and France have proven their worth, have recruited vast armies of soldiers and funds. The advertising men of America now have the glorious privilege of serving their country in like manner, and we shall count it an honor to be permitted to spend and be spent in the great righteous cause. Not alone in the actual Liberty Loan advertising and in the advertising of loans which will follow, but in our regular advertising we can suggest and encourage a patriotic line of action which in the aggregate may be of great importance.

I might carry out the analogy of the architect and the house in detail and mention concrete, practical things to be done in building good advertisements. But you know how to select a good site—what mediums and what position; you know how to build a firm foundation—the facts of your business; you know how to rear a noble superstructure—a clear statement of your message, and you know how to adorn it with comely decorations—illustrations, borders, and good type.



Reasons Why.—This folder, published by the Safe Deposit and Trust Company of Pittsburgh, gives ten reasons for appointing this trust company as the executor of a will. It makes a handy envelope stuffer and offers some convincing arguments.

Banking by Mail.—This attractive booklet issued by the Guardian Savings and Trust Company of Cleveland, presents in a simple and readable manner full directions and instructions for opening and maintaining a savings account by mail.

Ready.—This booklet, issued by the Cleveland Trust Company, shows how to provide for insurance premiums by regular deposits in the bank's savings department. This bank has a very comprehensive scheme for cooperating with the insurance companies.

When You Leave the World Behind.—This booklet, issued by the trust department of the Security Trust and Savings Bank of Los Angeles, presents in a dignified manner the advantages of appointing that company as trustee.

Enough if Something, etc.—This booklet, issued by the Columbia Trust Company of Salt Lake City, explains the various capacities in which this company is authorized to act and points out how these capacities may be advantageously utilized by its customers. It is an attractive booklet, and written in a clear, readable manner.

Base Ball Schedule.—Cleveland "fans" are doubtless grateful to the Guardian Savings and Trust Co. for this conveniently arranged schedule and score record for all

games played this season by the Cleveland Base Ball Club.

Bank Forms.—This is volume three in the Cleveland Trust Company Library of Banking. The present volume explains the various forms and documents used in banking which concern the public, such as checks, deposit slips, drafts, notes, etc.

Cold Fur Storage.—This little booklet with post card order form attached explains the cold fur storage facilities of the Guardian Savings and Trust Company of Cleveland.

Finding the Mutual Idea in Your Bank Account.—The booklet, issued by the New Hampshire National Bank, Portsmouth, N. H., is designed to create a spirit of mutual understanding and good will between bank and customer.

How Banks Are Advertising

In these columns each month current publicity matter will be reviewed and criticized

¶The problem of advertising two affiliated institutions of different names is successfully solved in "Under One Roof," a pamphlet issued by the Old National Bank and the Union Trust Company of Spokane. These two institutions are now housed in remodeled and enlarged banking rooms "under one roof."

The building, one of the finest in Spokane, is prominently featured and the fact that the two institutions offer under one roof every kind of banking facility is strongly emphasized.

The booklet with an accompanying letter was sent to every home in Spokane. We reproduce elsewhere the full page newspaper advertisement which announced the completion of the new quarters.

¶The Irving National Bank of New York features its trade-mark — a lozenge-shaped design with the name of the bank around the edge and "B/L" in the center — in magazine copy now appearing. The advertisement reads:

"HOW THIS TRADE-MARK WAS SELECTED.

"With a business entirely of a commercial character, the Irving National Bank naturally was called upon to collect a large volume of Bill of Lading drafts. To expedite collections a special organization was created to handle these items.

"The selection of the B/L symbol as a trade-mark sim-

ply indicates that the Bill of Lading Department is one example of specialization; every department is organized to render special service. . . ."

¶The Northumberland National Bank of Northumberland, Pa., presented its May 1 statement in a little folder entitled "Regarding Your Bank," which gave a brief and interesting history of the bank.

This is not much more expensive than just getting out a simple statement, and yet it is infinitely more effective as an advertisement.

¶In a series of seven advertisements the Federal Title & Trust Company of Beaver Falls, Pa., recently pointed out the service that it was prepared to give in helping its customers to own a home of their own. The first advertisement, which was in the form of an announcement, follows:

It is our purpose to publish in this paper a series of seven advertisements which will point out the service this institution is in position to give you if you want to own a home of your own.

In these few advertisements we shall set forth some things of importance to those considering the purchasing of a home.

Please do not misunderstand our motive. We do not care to run anybody's business but our own. If we can help any citizen of Beaver Falls in acquiring a home we shall feel we have contributed to the campaign to make Beaver Falls a better town to live in.

Watch for these advertisements and talk to us if they interest you.

The captions of the six following advertisements were: "How You Can Pay It Off," "Will You Call and See Us?" "We Will Loan

You This Money," "Have You \$250?" "Do You Want Your Own Home?" "What Money You Need."

¶Flag Day, June 14, offered an opportunity for some effective bank publicity which was taken advantage of by at least one bank in the country, the Guaranty Trust & Savings Bank of Los Angeles.

Plans were laid for the advertising coup about two months previously when 10,000 small silk lapel flags were purchased by the bank, this being practically all of the available supply in the city. Just one week before Flag Day two window displays were put in showing the little flags and calling attention to the fact that one would be given away free to each person calling at the Bank on June 14.

On the day preceding Flag Day an advertisement was placed in all the local papers telling of the flag souvenirs to be given away.

"The effect of this publicity and the appropriateness of the flag souvenirs in the light of current conditions almost swamped the working force of the Bank on Flag Day," said F. A. Stearns of the Publicity Department. "Practically all of the flags were given away before noon so great was the demand, and wherever one went on the streets that day he could see people wearing the little flags from the Guaranty Bank."

Mr. Stearns gives the cost of this publicity effort as less than \$250 for flags and advertising space, and states that it was worth considerably more than this in the

The Spirit of The Liberty

VISITORS from Western cities frequently remark that the spirit of cordiality at THE LIBERTY exceeds that of the West. We regard this as a high commendation and an evidence that we are succeeding in what we try to accomplish — to make all visitors, new customers and old customers feel at home in this bank.

The phrase "our family of depositors" has a general meaning, embracing an extensive number of all customers of THE LIBERTY fully understood and appreciated.

Our officers will be glad to have you call and talk with them regarding your banking business; they will be still more glad if they can offer a suggestion which will be of any value to you.

LIBERTY NATIONAL BANK
in the Equitable Building
120 Broadway, at Cedar St.

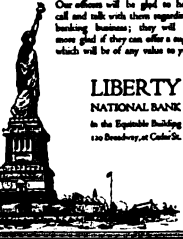

Loyalty at the Liberty

The loyalty of our clients is one of our biggest assets. It is not quite as tangible, perhaps, as our \$10,000,000 resources, but it is just as significant.

Our depositors are loyal now because in the past we have served them well. Their firm loyalty is the foundation of our present strength; it is one reason why we are so well able to serve you, now and in the future.

To corporations, business firms and individuals, we offer all the conveniences of modern banking, together with the increased, personal service of our officers, which should prove of much value to you.

LIBERTY NATIONAL BANK
in the Equitable Building
120 Broadway, at Cedar St.

A Large Bank with the Small Bank's Intimate Personal Service

While THE LIBERTY has grown to be a large bank in point of resources (\$10,000,000), it has remained comparatively small in the number of its depositors. Its officers have kept and intend to keep in just as close personal touch with its customers as the officers of any small neighborhood or country bank could do.

With our enlarged facilities we still have room, without lowering our standard of personal service, for many more members in our "Family of Depositors." You are urged to investigate THE LIBERTY'S services.

LIBERTY NATIONAL BANK
in the Equitable Building
120 Broadway, at Cedar St.

THIS YEAR 1916

our 25th Anniversary has been celebrated by establishing ourselves in convenient, commodious, and well equipped quarters in the new Equitable Building.

It seems fitting that we publish from week to week during this year, announcements which will tell the story of THE LIBERTY'S remarkable growth from a small to a large bank.

During these conservative yet aggressive years of business building, we have advertised very little. Now, having attained a place among the larger banks of New York City, we believe this 25th Anniversary an opportune time for letting the general public know who, what, and where we are; hence our decision to advertise.

LIBERTY NATIONAL BANK
in the Equitable Building
120 Broadway, at Cedar St.

Success to Our Depositors

It has been and always will be the policy of THE LIBERTY for its officers to manifest a friendly personal interest in the welfare of depositors. We do more than merely wish for the success of our depositors; we work for their success, because we realize that the success of the bank are closely bound up with the welfare of its customers.

To this policy we attach in our the remarkable growth of THE LIBERTY, which now ranks as one of the larger banking theories. You are urged to investigate our ability to meet your banking requirements.

LIBERTY NATIONAL BANK
in the Equitable Building
120 Broadway, at Cedar St.

The Liberty Has Only About 2,000 Depositors

You will deposit of \$10,000,000, it makes us one of New York's large banking institutions.

The standing of our depositors and their loyalty through years of steadily profitable growth-up together to the foundation of our present strength.

These comparatively small number enables our officers to devote to each client the personal thought and interest to which he is entitled.

Both our staff and our facilities have recently been enlarged so that we are now prepared to handle the same quality of personal, individual service as is afforded by larger banks of clients.

You are invited to make a personal loan-give us of our facilities.

LIBERTY NATIONAL BANK
in the Equitable Building
120 Broadway, at Cedar St.

The advertising of the Liberty National Bank has a distinctive atmosphere of cordiality, strength, and personality which perhaps accounts for the remarkable increase in deposits of this bank during the past few years

good-will and favorable impression engendered in Los Angeles people toward the bank.

¶The services rendered by a trust company are many and offer the advertising man a wide range of copy appeal. "Twenty-five Links in a Chain of Banking Service" is the appropriate caption of a circular issued by the Cleveland Trust Company, which summarizes the following services which it is equipped to perform for its depositors:

The Cleveland Trust Company can:

1. Accept savings deposits of one dollar or more, and pay interest at the rate of four per cent. per annum, compounded semi-annually.
2. Issue interest-bearing certificates of deposit in amounts of not less than \$100 and not more than \$25,000.
3. Accept deposits and honor withdrawals by mail, from patrons residing anywhere in the postal union.
4. Accept the checking accounts of individuals, partnerships, or corporations, and pay two per cent. interest on daily balances in excess of \$500.
5. Loan money on approved Cleveland real estate at six per cent. interest.
6. Loan money on approved collateral, such as stocks and bonds listed on the various exchanges of the country.
7. Sell bonds netting from four per cent. to six per cent. income, offering only such as meet the requirements for our own investments.
8. Send money to, or collect money in foreign countries for you at lowest current rates.
9. Issue letters of credit and travelers' checks for use under normal conditions in any part of the world.
10. Sell or buy for you a house, a lot, an apartment, a business block, a farm or a lease.
11. Act as agent for the care and management of property, real and personal, and take entire charge of investment and collection of income, renting, repairing, insuring and general control.
12. Rent you a safe deposit box in one of the strongest armor plate vaults in the world, where you can keep valuable papers and jewelry at a cost of only \$5 upwards a year.
13. Store your silverware, paintings, bric-a-brac, rugs or

other bulky parcels in its storage vaults at a moderate cost, sending private delivery auto under guard to call for or deliver packages.

14. Store your furs in the dry freezing atmosphere of special vaults that are moth-proof, fire-proof and theft-proof.

15. Advise with you and act for you in the matter of investments, whether real estate or securities.

16. Act as executor or trustee under your will, thereby bringing to your estate the benefits of the wide experience of a board of directors composed of twenty-eight representative business men of Cleveland.

17. As trustee under a living trust agreement; manage your real estate in whole or in part; take care of the collection, disbursement and remittance of income and make investments for you.

18. As beneficiary under a trust agreement; collect life insurance; invest the proceeds and disburse the income, and ultimately the principal, as you direct.

19. Act as trustee for bond issues or as assignee and receiver, handling all such business with impartiality and skill.

20. Act as custodian of securities of absentee owners, collecting principal and income, and deposit the proceeds as directed.

21. Act as fiscal agent under corporate trusteeships, handling the disbursements of dividends and other funds and taking care of the payment of bonds and coupons.

22. Act as fiscal agent for fraternal, educational, charitable, social, civic and religious organizations or for individuals representing them.

23. Act as transfer agent and registrar of stocks of corporations.

24. Render expert public accounting service; audit books; open and close books, install systems, etc., with maximum efficiency and economy.

25. Give you the convenience of sixteen banking offices, and a broad banking service, characterized by safety, efficiency and courtesy.

INVITATION



INFORMAL OPENING **JUNE 9th 1917**

THE OLD NATIONAL BANK
and
UNION TRUST COMPANY
OF SPOKANE

The officers and directors of The Old National Bank and its affiliated Union Trust Company take pleasure in extending to the people of the Inland Empire a most cordial invitation to attend the informal reception to be held in the newly remodeled and enlarged banking rooms, Saturday evening, June ninth. In these spacious new quarters, patrons of these two institutions will now be afforded

A COMPLETE FINANCIAL SERVICE UNDER ONE ROOF

The equipment embraces many new features which will greatly facilitate the work of each department, and the artistic beauty of the room as a whole should prove a source of pride to the people of Spokane and the Inland Empire.

The directors take this opportunity of thanking all who have made possible the splendid success of these two institutions, and express the hope that by the same broad and safe methods, their continued confidence and good will may be merited.

THE OLD NATIONAL BANK OFFICERS

B. W. THORNTON, President
 T. J. WHEELER, Vice President
 W. B. VINCENT, Vice President
 J. A. TROSTMAN, Cashier
 W. J. SMITHSON, S. H. GREENWOOD
 J. W. BLANP, S. L. JENKINS
 Assistant Cashiers

THE capital stock of the Union Trust Company is owned by the shareholders of The Old National Bank and the directors of the two institutions are the same.

UNION TRUST COMPANY OFFICERS

B. W. THORNTON, President
 W. J. WHEELER, Vice President
 J. A. C. CHRISTIANSEN, Vice President
 J. W. HENDERSON, Vice President
 FRANK C. PAINE, Secretary
 STEVE E. BLAKE, Treasurer
 HAROLD E. FRANK, Asst. Secretary

JOINT DIRECTORS

JAY R. GRAY, Vice-Chairman
 W. W. GARDNER, Assistant Secretary
 R. F. PATTERSON, Assistant Secretary
 H. C. COBBIN, Assistant Secretary
 J. C. LINDSEY, Assistant Secretary
 J. W. HENDERSON, Assistant Secretary
 J. A. C. CHRISTIANSEN, Assistant Secretary
 W. B. VINCENT, Assistant Secretary
 W. J. SMITHSON, Assistant Secretary
 S. H. GREENWOOD, Assistant Secretary
 J. W. BLANP, Assistant Secretary
 S. L. JENKINS, Assistant Secretary

Combined Resources

\$25,000,000

The typographical arrangement of this full page announcement leaves nothing to be desired. It shows that there's all the difference in the world between a carefully planned advertisement and one that is simply thrown together regardless

Some interesting facts concerning the direct result producing powers of bank window displays are given by F. A. Stearns of the Publicity Department of the Guaranty Trust & Savings Bank of Los Angeles.

"The Guaranty Bank instituted its regular window display service in the latter part of November, 1916. The results in new accounts and the favorable public interest aroused were really amazing right from the start, and the business of the bank continued to increase at a rapid rate on through the winter and spring months. Of course the bank uses many other advertising mediums in its business-building—newspapers, booklets, direct-mail advertising, etc., and, as all bankers know, it is rather difficult to trace definitely the proportion or amount of new business brought in by any one medium.

"However, in the middle of May there were some changes made in the bank's building which necessitated the temporary withdrawal of window displays for three weeks. Now, right up to the time of the withdrawal of the displays the bank had been opening regularly about fifteen Home Bank accounts a day, that is, accounts with which were loaned Home Banks. But immediately upon stopping our displays this class of accounts dropped off to two or three a day, which in view of the fact that our Home Safes are advertised only through the windows was very significant.

"The number of Home

Bank accounts opened per day continued at about this figure during all the time the windows were out. However, on June 6 the displays were again installed, two of which were devoted to advertising Home Banks. On June 7 we opened thirteen Home Bank accounts and the average has continued at the same rate ever since.

"Such evidence as this should certainly prove a convincing argument for the efficacy of bank window displays, and when it is realized that Home Bank accounts represent but one of the fields of banking covered by the displays, the real business-building qualities of bank windows offer wonderful possibilities."

Mr. Stearns considers the window displays as easily the most effective direct-result producing medium at the command of banks today.

The main talking points that should be brought in in advertising trust company service are well summarized in the last chapter of "Concerning Wills and Trusts," a booklet issued by the Old Colony Trust Company of Boston. These were grouped under five headings as follows:

PERMANENCY

This company is a permanent institution. It is never sick. It never dies. It grows in strength. Its ability is cumulative. It is unaffected by influence of any sort. Its sole purpose is to carry out faithfully every instruction in your will or agreement.

SECURITY

Your property is protected from fraudulent management by the bond of the company which assures the faithful performance of all its trust duties. It is protected from loss by a capital, surplus and stockholders' liability of \$18,000,000.

ACCESSIBILITY

The trust department is available every business day of the year. At all times, one or more trust officers may be found to give personal attention to your affairs.

QUALIFICATION

The company has had years of experience in trust work. Each action affecting trusts is directed by the judgment of trained and conservative business men, and every investment is supervised by a special committee of directors who are expressly chosen because of their knowledge of the financial and business world.

COMPENSATION

The charges for trust service are no more than those made by individuals acting in like capacities, and the reasonableness of such charges are determined by the Probate Court.

Why impose the burden of settling or caring for your estate upon a member of your family or some friend when, with greater advantage, you can appoint the Old Colony Trust Company to the task? Caring for estates and trusts is one of the primary objects of the Trust Company, and it has every facility for managing them safely and advantageously.



JOINS NEW BUSINESS DEPARTMENT

H. G. Stenerson has been appointed to the new business department of the National Bank of Commerce in New York. He has had nine years of experience in different cities throughout the United States as cashier of branch offices of the Travelers Insurance Co. of Hartford, Conn.



CLAUDE M. DAVENPORT A "FREE LANCE"

Claude M. Davenport, formerly publicity manager of the Bank of Italy, Los Angeles, has opened an office at 332 Mason Building, Los Angeles, Cal., and will specialize in financial advertising, especially in booklets and pamphlets for banks and trust companies.

Bank Advertising Exchange

Those listed herewith are willing to exchange booklets, folders and other advertising matter issued by them. Subscribers can get on this list free of charge

Watch for New Names and Other Changes

A

Adams, F. R., Will County National Bank, Joliet, Ill.
American National Bank, Richmond, Va.
Anasley, D., c/o Central Trust Co., San Antonio, Tex.
Art, Carl W., manager publicity department, Union Trust Co., Spokane, Wash.

B

Bader, A. F., publicity manager, Old State National Bank, Evansville, Ind.
Bailey, C. W., cashier, Southern Trust Co., Clarksville, Tenn.
Bank of San Rafael, San Rafael, Cal.
Bankers Magazine, The, New York.
Baugher, E. M., president, The Home Building Association Co., Newark, O.
Beerbower, C. W., National Exchange Bank, Roanoke, Va.
Bollman, H. C., assistant cashier, First National Bank, Collinsville, Okla.
Branham, D. R., 6252 Leland Way, Los Angeles, Cal.
Brannen, Jesse E., cashier, First National Bank, Westwood, N. J.
Brooks, T. J., cashier, The Guaranty Trust and Savings Bank, Jacksonville, Fla.
Brown, R. A., assistant cashier, Citizens National Bank, Raleigh, N. C.
Bunch, F. B., cashier, Merchants and Farmers Bank, Statesville, N. C.
Burton, E. C., vice-president, Penn. National Bank, Chester, Pa.
Burwell, Stephen L., vice-president, First National Bank, Jackson, Miss.
Bush, A., Jr., Ladd & Bush, bankers, Salem, Ore.

C

Citizens Bank and Trust Co., Tampa, Fla.
Citizens National Bank, Oconto, Wis.
Commercial Bank, Midway, Ken.
Copp, H. Reed, assistant advertising manager, National City Bank, New York City.
Cory, Arthur S., Chehalls National Bank, Chehalls, Wash.
Craig, David, Tradesmen's National Bank, Philadelphia, Pa.
Critchell, L. S., publicity manager, Guaranty Trust Co., New York City.
Crowson, M. Clarence, cashier, Home Banking Co., High Point, N. C.
Cubreth, Eugene E., Commercial National Bank, Raleigh, N. C.
Currey, Bradley, c/o Fourth and First National Bank, Nashville, Tenn.

D

Dalby, H. A., Naugatuck Savings Bank, Naugatuck, Conn.
Davenport, C. M., manager new business department, Bank of Italy, Los Angeles, Cal.
Dexter Horton National Bank, Seattle, Wash.
Durham, T. R., assistant cashier, Chattanooga Savings Bank, Chattanooga, Tenn.
Dysart, W. R., assistant cashier, First National Bank, Ripon, Wis.

E

Eherspracher, J. C., assistant cashier, First National Bank, Shelbyville, Ill.

Ekirch, A. A., secretary, North Side Savings Bank, New York City.
Ellsworth, F. W., secretary, Guaranty Trust Co., New York City.

F

Finch, E. W., assistant cashier, Birmingham Trust and Savings Co., Birmingham, Ala.
First National Bank, Lead, S. D.
Franklin Society, 38 Park Row, New York City.
Frieden, Ben W., 334 Davidson Building, Sioux City, Iowa.

G

German-American Bank, Springfield, Mo.
Gooden, B. P., Mercantile Bank of the Americas, New York City.
Groves, J. W., advertising manager, Northwestern National Bank, Minneapolis, Minn.

H

Hamsher, C. F., First National Bank, Los Gatos, Cal.
Hann, Victor F., manager publicity department, The Fifth Avenue Bank, New York City.
Hardee, D. L., publicity manager, Wachovia Bank and Trust Co., Winston-Salem, N. C.
Harper, W. A., Lumberman's National Bank, Houston, Tex.
Hatton, E. A., cashier, First National Bank, Del Rio, Tex.
Hill, John R., Barnett National Bank, Jacksonville, Fla.
Hoagland, Jessamine G., publicity manager, National City Bank, Chicago, Ill.
Hokanson, N. M., State Bank of Chicago, Chicago, Ill.

J

Jarvis, Charles D., c/o Savings Bank of Utica, Utica, N. Y.
Jenkins, W. L., Farmers and Mechanics Trust Co., West Chester, Pa.
Jessup, Theodore, Woodlawn Trust and Savings Bank, 1204 E. 63rd Street, Chicago, Ill.
Jones, W. P., assistant cashier, First National Bank of Commerce, Hattiesburg, Miss.

K

Kahn, A. T., vice-president, Commercial National Bank, Shreveport, La.
Kankakee County Trust and Savings Bank, Kankakee, Ill.
Kay, W. R., Jr., advertising manager, Sacramento Bank, Sacramento, Cal.
Keller, C. B., Jr., assistant cashier, Stroudsburg National Bank, Stroudsburg, Pa.
Keyton, Grover, New Farley National Bank, Montgomery, Ala.

L

Lanier, B. W., First National Bank, Lakeland, Fla.
Lindhjem, A. E., assistant cashier, Scandinavian-American National Bank, Minneapolis, Minn.
Logan, John, cashier, Columbus State Bank, Columbus, Mont.

M

McDowell, J. H., c/o American Trust and Banking Co., Chattanooga, Tenn.
Mann, Ralph H., Park Trust Co., Worcester, Mass.

Marvel, Charles S., The First-Second Savings and Trust Co., Akron, O.
 Matthews, Dave S., assistant cashier, Farmers and Merchants Bank, Stockton, Cal.
 Matthews, H. B., S. W. Straus & Co., Straus Building, Chicago, Ill.
 Merrill, Frank, advertising manager, The Northwestern National Bank, Minneapolis, Minn.
 Meyer, A. J., Union Trust Co., Rochester, N. Y.
 Mills, W. C., New Business Department, Metropolitan Trust Co., 60 Wall Street, New York City.
 Multhead, G. C., vice-president, The Stock Growers State Bank, Worland, Wyo

N

Northwestern Trust Co., R. P. Sherer, vice-president, St. Paul, Minn.
 Norton, W. W., treasurer, Robbins Burrall Trust Co., Lakeville, Conn.

O

Old State National Bank, Evansville, Ind.
 Overton, J. A., cashier, The National Bank of Smithtown Branch, Smithtown Branch, N. Y.

P

Parish, R. B., cashier, Bluefield Bank, Bluefield, W. Va.
 Poole, John, president, Federal National Bank, Washington, D. C.
 Potter, A. E., president, Broadway National Bank, Nashville, Tenn.
 Potts, W. W., treasurer, The Federal Title and Trust Co., Beaver Falls, Pa.
 Publicity Department, St. Louis Union Bank, St. Louis, Mo.

R

Ruff, William J., cashier, Luzerne County National Bank, Wilkes-Barre, Pa.
 Russell, W. W., cashier, First National Bank, White River Junction, Vt.

S

Schlenker, Almot, assistant cashier, First National Bank, Brenham, Tex.
 Schulze, Paul T., assistant cashier, State Bank of La Crosse, La Crosse, Wis.
 Scott, Walker, vice-president, Virginia Trust Co., Richmond, Va.

Shepherd, George W., c/o International Trust Co., Boston, Mass.
 Smith, A. C., vice-president, City National Bank, Clinton, Iowa.
 Smith, T. K., Jr., manager, Gimbel Brothers, bankers, New York City.
 Stephenson, J. E., Atlantic National Bank of Jacksonville, Jacksonville, Fla.
 Stewart, F. E., Chesborough Dwellings, Jefferson Avenue, Toledo, O.
 Stoner, T. H., cashier, The Peoples National Bank, Waynesboro, Pa.
 Stover, J. C., secretary-treasurer, Indiana Savings and Loan Association, South Bend, Ind.

T

Taylor, C. E., Jr., president, Wilmington Savings and Trust Co., Wilmington, N. C.

U

Union Trust Co. of D. C., Washington, D. C.

V

Van Blarcom, Wessels, assistant cashier, Second National Bank, Paterson, N. J.
 Van Name, Miss M. I., 515 Stephen Girard Building, Philadelphia, Pa.

W

Wadden, John W., Lake County Bank, Madison, S. D.
 Williams, F. H., assistant treasurer, Albany City Savings Institution, Albany, N. Y.
 Williams, J. E., assistant cashier, Third National Bank, Scranton, Pa.
 Wilson, C. C., c/o Continental and Commercial Trust and Savings Bank, Chicago, Ill.
 Withers, K. K., publicity manager, County Savings Bank, Scranton, Pa.

Z

Zimmerman, Frank A., Chambersburg Trust Co., Chambersburg, Pa.
 Zimmerman, Paul E., cashier, Oak Park Trust and Savings Bank, Oak Park, Ill.

NEW NAMES

Bauder, Ray E., cashier, First National Bank, Taylorville, Ill.



A War of Wills

By ADOLPH C. MILLER Member Federal Reserve Board

WAR against the Imperial German Government "to make the world safe for democracy" means to me, primarily, war to break the stubborn will of the most stiffnecked, iron-blooded oligarchy that, since the breakdown of feudalism in Europe, has ever taken possession of the life and destiny of a powerful and docile people, and sought to impose its will upon them and through them upon the world. Drunk with power, and with a will that is

mad with lust for dominion, the will of the Junker oligarchy of Prussia must be broken. But it will not be, unless we match its will with a will of our own as strong for the things we know to be right as theirs is for the things we know to be wrong. It is a big and difficult, but heroic and noble, enterprise on which we have entered. It calls for men, it calls for munitions, it calls for money. But more than these, it calls for will power, for this is a war of wills.

International Banking and Finance

Emancipated Russia

By RODNEY DEAN

III.—RUSSIA'S FUTURE DEVELOPMENT AND AMERICA'S OPPORTUNITY

IN my last article I briefly discussed Russia's financial problems arising from the war, and pointed out that their successful solution and the restoration of rouble exchange lay in the development of her natural resources and domestic manufactures, with a view to the immediate creation of a favorable trade balance and the eventual growth of Russia as a manufacturing nation. Let us now take up this process in detail.

First, as to the situation of Russia's foreign trade. For the decade preceding the outbreak of war her balance of trade was always favorable, but this favorable trade balance had not shown a healthy increase year by year. Russia's chief problem is therefore to create a large favorable trade balance, thereby improving rouble exchange. This must be done by increasing her exports of raw materials and decreasing her imports of those raw materials and manufactured articles which can be found or produced within her own borders.

At the head of the list of Russia's exports, and forming over one-half of the total, stand agricultural products. It is generally conceded by Russians that agricultural development should precede any industrial development of the country. Russia is preëminently an agricultural country, with 140,000,000 peasants, out of her total population of 180,000,000, occupied in tilling her vast areas of fertile farm land. What is needed is therefore not land or workers. A more rapid change from communal to individualistic methods, for

one thing, would be desirable. For some time all land worked by peasants was held by communes and reapportioned every few years among the members. This system naturally did not make for efficiency or initiative, and during the last decade several million peasant farmers have taken advantage of changed laws to take over perma-



Mosque, Vladicaucase

nently their own little farms. Again, there is need of a more scientific and intensive cultivation, producing a satisfactory yield per acre. Hitherto, in spite of the successful introduction of American agricultural machinery, methods of farming have been in most cases exceedingly primitive. In many parts of Russia, for instance, one still finds wooden plows. There is also a lack of such collateral aids to agriculture as an up-to-date system of grain elevators. Russia, the granary of the world, has hitherto had inadequate facilities for

transporting and storing grain, although it is true that the Government has embarked to some extent on a programme of elevator construction in the provinces of the southeast. If such measures are energetically pushed, Russia should be in a position to derive much benefit from the inevitable



A Street in Vladicaucase

universal demand for foodstuffs following the war.

Upon the declaration of peace another pressing need of devastated Europe will be timber for rebuilding purposes, and here again Russia will have a golden opportunity. Russian forests form the timber reserve of Europe, and, in fact, the world, being equal in area to those of the United States and Canada put together. The most thickly wooded districts lie in the extreme north of Russia, and around the Ural Mountains.

Russia's mineral deposits are acknowledged to be almost limitless. Precious metals are found in the Urals and Siberia, coal in the Donetz basin, and oil in many localities, notably the fields of Baku on the Caspian Sea. In spite of the richness of these deposits, large quantities of coal and other mining products have hitherto been imported yearly. After the war Russia will undoubtedly continue her policy, already begun, of full investigation and encouragement of the mining and petroleum industries, with the added incentive of the necessity for developing her favorable trade balance.

Much cotton is grown in the irrigated districts of Russian Central Asia, and

the Russians are desirous of having this industry developed so as to supply all their own requirements and check the import of cotton from abroad. A great variety of fruits, also, is produced in Central Asia, as well as in the southern portions of European Russia. These, however, cannot be generally marketed because of the lack of refrigeration. Cold storage facilities, too, would immensely advance the meat products industry, which is still in its infancy in Russia.

EXTENSION OF THE RAILWAY SYSTEM

Inseparable from the general question of industrial and economic development is that of railway extension. Excluding Finland, Russia has only 65,000 versts, or about 44,000 miles, of railway lines. Two-thirds of this total consist of state railways, of which there are 33,000 versts in European Russia, and 11,000 versts in Asia. The private railway systems, which are practically all in Europe, amount to 21,000 versts. Russia, therefore, has in all less than one-fifth the length of railway lines of the United States, although nearly three times as large as this country. It can be easily seen that the present facilities are grossly inadequate and capable of enormous development. It is hoped that after the war from 4,000 to



A Petrograd Canal

5,000 miles of new railways will be constructed annually. These new lines would not lack for business. It is a saying in Russia that a railway can be built between any two points, and it will pay immediately. A feature of



IN developing commercial relations between the United States and Russia, correspondents and customers of the Irving National Bank are invited to make liberal use of its unusual foreign trade facilities.

IRVING NATIONAL BANK

WOOLWORTH BUILDING



NEW YORK

Strictly A Commercial Bank

Resources over \$100,000,000

the Russian railways which is unique in Europe is that their passenger traffic is profitable. The Russian people are confirmed travellers. Even the peasants are in many cases also artisans, and travel back and forth from the towns to the country, forming a seasonal traffic. The third-class carriages are always crowded. There is no doubt that the future of the big private railway systems (of which there are seven) is assured. Most of the state railways also operate at a profit. They include the Nikolai Railway, connecting Petrograd and Moscow, and the Trans-Siberian Railway. This line, the best-known of Russian railways, is really a "route" and not a "railway," running as it does over several different systems between Petrograd and Vladivostok.

It was said above that Russia would have not only to produce more raw materials, but also to develop her manufactures. She has perceived the error of her former dependence upon Ger-

many for manufactured articles, and intends not to repeat this mistake, but to produce her own. There will, of course, probably be for some years a temporary market for American equip-



In the Caucasian Mountains

ment machinery and other manufactures. But in the long run America's opportunity in Russia will be along the lines of investment of surplus capital in the various Russian industries mentioned in this article, as well as many

other minor ones. Granted an increase in technical knowledge, investment capital is, as we have seen, the only thing lacking to Russia's industrial development. Moreover, America is the logical source of this capital. The nations formerly lending to Russia will after the war be financially exhausted; they will have no funds, as before, to place abroad in foreign enterprises; while we, on the other hand, will probably have accumulated a large surplus. Besides, not the least powerful motive for Russia to prefer American capital is that there are no political "strings" attached to it. She can accept the proffered assistance, confident that unqualified benefits will accrue.

Still another field for American capital in Russia will be that of municipal

improvement, of which there is great need. Of Russia's 1,231 cities, only fifty-four have street cars, and only sixty-five sewer systems. There is a corresponding lack of electric lights, telephones, etc. All these things Russia is going to have after the war, and will look to us to supply.

Previous to the war and the resulting revolution, even the old régime in Russia had recognized the importance of developing the country's resources. Now, however, in the present state of Russian finances, this development is a pressing, vital necessity; and it will not, as formerly, be hindered by political obstacles, but will, on the contrary, be eagerly urged and assisted by the liberal-minded leaders of emancipated Russia.

The Monetary Situation in Chile

By JOHN S. DURLAND

Manager New York Branch Banca Commerciale Italiana

ALTHOUGH Chile has an outstanding issue of 150 millions of depreciated paper money, the use of gold is not entirely obsolete and the gold standard of 1895 is still in existence. However, the stock of gold in the country is so small that it is seldom seen outside the banks. The consoli-

dated cash statement of these institutions showed approximately five million pesos in gold on December 31, 1916. Checking accounts in gold are carried by most of the big houses engaged in foreign trade and checks drawn in gold of eighteen pence (the common way of designating legal-tender gold coins) are

COX & CO. (France) Ltd.

place their branches in France at the disposal of the Military and Naval forces of the United States, in Europe, for the remittance of funds and general banking business.

This bank was formed as a subsidiary of Cox & Co., founded in 1758, 16 Charing Cross, London, the official British Army Agents, for the convenience of the British Army in France.

Branches have been established with a British Staff at all the chief military bases.

Paris, Rouen, Havre, Boulogne, Amiens, Marseilles,

and agencies at

COX & CO., 16 Charing Cross, London,

and

LONDON & SOUTH-WESTERN BANK, LTD.,

170 Fenchurch Street, London.

who are the joint proprietors.

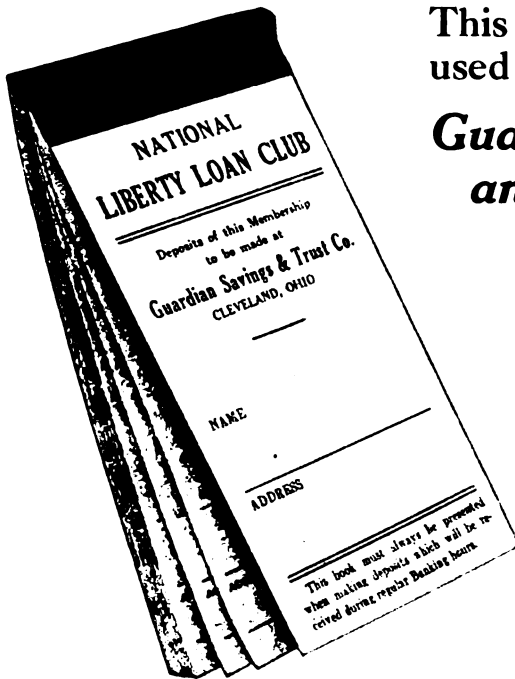

Coupon Book

This Coupon Book was used by the

Guardian Savings and Trust Co.,

Cleveland, Ohio

and referred to on the opposite page.

The "last word" in accounting systems for any weekly payment or Club plan—

Thrift, Liberty Loan, Christmas, Etc.

Description

The Coupon Book illustrated above contains fifty pages, each page a stub and detachable coupon. The Receiving Teller with one motion places the depositor's receipt on the stub and the date of deposit on the coupon. Both stub and coupon bear the amount of deposit and the account number. The coupon is then torn out and becomes the Bank's record of deposit and the stub is the depositor's record.

The Bank's record must therefore always agree with the Depositor's.

This Plan is not only the fastest but *by far* the safest yet devised for the handling of regular weekly payments.

The Bankers Service Corporation Plan is **fully covered by patent.**

Every detail of this plan has been carefully worked out to avoid delays and unnecessary labor.

Now is the time to prepare for the second issue of the Liberty Loan. For full information without obligation write Club Department

The Bankers Service Corporation
258 Broadway, New York

The Bankers Service Corporation of New York

Offers to client Banks a Service based on experience and measured by results—for the increasing of deposits.

We would welcome the opportunity of pointing out to you some truly remarkable records of growth resulting from plans devised and executed by us.

Service in its true sense is our utmost endeavor. May we not have a word from you on your advertising problems?

**Bankers Service Corporation
258 Broadway, New York**

not uncommon, although they are not to be compared in number with those

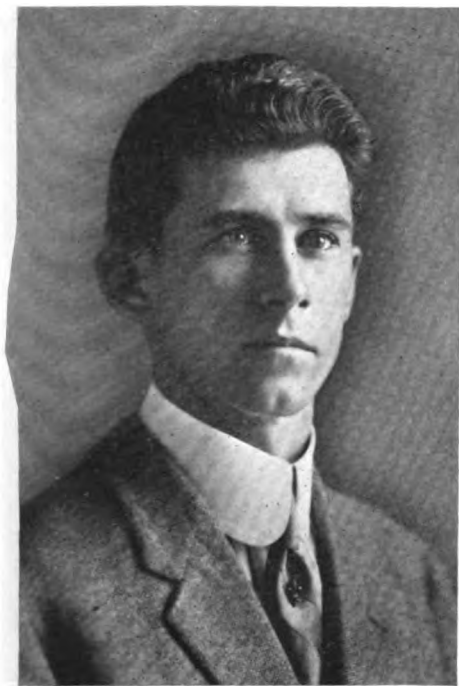

JOHN S. DURLAND

Manager New York Branch Banca Commerciale Italiana

Mr. Durland was born in Kansas in 1876, and was educated in banking and commerce in Europe. For some time he was the head of the endowment division, policy claims department, of the New York Life Insurance Company. He became a member of the staff of the North American Trust Company when it was appointed fiscal agent of the United States War Department in Cuba, and took part in the organization of the Company's Havana branch. Mr. Durland later became secretary of the Company for Cuba and organized and managed several of its branches, as well as of the National Bank of Cuba, which took over its business in 1901. He afterwards became cashier of the bank, continuing to serve in this capacity until 1905. Interests connected with the National City Bank of New York and other prominent banking institutions having organized the Bank of Havana, in 1906, Mr. Durland became manager of the foreign exchange department, being successively promoted as assistant manager, manager, and vice-president, and remaining with this institution as manager after it was converted into the West Indian Branch of the National City Bank of New York, with headquarters at Havana and a branch at Santiago. In 1916 Mr. Durland gave up the management of this bank in order to go to Chile for the purpose of organizing at Valparaiso a branch of the National City Bank of New York. When this branch was in good running order, he returned to the National City Bank, remaining one of its officers until his resignation on August 1 to become manager of the New York branch of the Banca Commerciale Italiana.

It will be seen that Mr. Durland's wide experience in international banking with important institutions admirably qualifies him for the duties of his new position.



Advice to Investors

Purchase your securities through responsible dealers who have proper facilities for investigations and a reputation to maintain for reliable advice.

K. N. & K. are always posted on general market conditions, and their views are at the disposal of investors through their monthly review of

"The Investment Situation"

Write for pamphlet I-I

Knauth · Nachod & Kuhne

Members of New York Stock Exchange,

Equitable Building,

NEW YORK CITY.

issued in *moneda corriente*. However, a gold check is almost never presented for payment in cash, as the character of the payments so made is such that the checks are cleared through the banks. The only exceptions are of late date and due to the fact that the English banks refuse to receive checks on the German banks. There are also about three million pesos gold deposited with the Government at Santiago as security for part of the paper money circulation taken out by the banks. We have therefore a visible gold supply of say eight million pesos in the country to be compared with a paper circulation of say 150 millions.

Custom duties are calculated in gold but are really paid in paper money at the corresponding rate of exchange. This is also true of many wholesale prices on articles from abroad.

Although ninety-day sight bills on London are regularly quoted in gold pesos, as well as in paper money, on

Remittances to U. S. Forces Abroad

Through the medium of our offices in London, Liverpool, Manchester and our agents in Paris, we will be pleased to undertake remittances to the American forces in Europe, both Naval and Military.

NEW YORK AGENCY
**BANK OF BRITISH
WEST AFRICA, LTD.**

6 WALL STREET

R. R. APPLEBY, AGENT

HEAD OFFICE . . . LONDON

the stock exchange, the actual transactions in them for gold pesos are very few. Around the middle of last year 18 11/16 pence in ninety-day sight bills on London were obtainable, for each gold peso; at the end of the year the rate was 19 5/16 and to-day it is approximately 20. These rates, of course, are abnormal, and due to the war conditions which govern the freight and insurance rates on specie, as well as the value of ninety-day sight bills on London.

FOREIGN BILLS OF EXCHANGE AS CIRCULATING MEDIUM

The Government having failed to maintain a sufficient supply of stable circulating medium, business interests have found themselves obliged to create one by usage. Instead of a stable medium properly regulated in volume and

backed by the credit and good faith of the Government, one finds a fairly stable circulating medium backed by the signatures of banks or mercantile houses and limited in volume only by the will of its creators.

Due to the fact no doubt that for years the commerce of Chile was almost entirely in British hands and that she has been financed to so great an extent by England, the people are, one might almost say, more accustomed to thinking in terms of sterling than in their own money. Then again, nitrate, the dominating factor of the country, coal, copper and some other commodities, are bought and sold in sterling. Even the export tax on nitrate may be paid in part with "good" ninety-day sight bills on London, i. e., bills drawn by banks and mercantile houses which have given security to and have arranged with the Government that their bills be taken for this purpose up to a given amount.

The circulating medium which takes the place of gold consists of agreements, usually in writing and through a broker, to buy or sell first-class ninety-day sight bills on London, to be delivered on the next mail day or some future one. When maturity is reached delivery is often postponed to some future date by payment of a charge which varies with the condition of the market at the time. The postponements on a mail day often reach enormous figures, and of course have considerable influence on the value of paper money. In fact, it is said that some institutions operating heavily in *moneda corriente* are willing to pay the price and keep their risks covered in this way. No doubt many of the violent fluctuations are due to causes of this kind.

In order to avoid confusion as far as possible the Chamber of Commerce has defined what bills shall be considered first class. While in practice its classification is not strictly adhered to, in a general way it is followed, and in case of dispute, rules.

Among first-class bills one finds banks drawing on banks or bankers and

**Eligible to Secure
Government Deposits**

\$170,000

City of Yonkers, N. Y.

Registered 5% Bonds due 1922-26

Legal Investment for Savings Banks in New York

Exempt from personal taxes in New York
State and from the Federal Income Tax.

Eligible to secure postal savings deposits
at 90% of their par value.

Price, to yield 4.25%

Send for Circular 5048-F

Redmond & Co.

33 Pine Street,

New York

in some cases on their own branches, mercantile houses drawing on banks or bankers, and even on themselves under another firm name in London. It goes without saying that large quantities of these agreements are bought and sold without there being any intention on the part of the contracting parties to ever issue and receive the corresponding bills of exchange. To such an extent are bills on London a circulating medium that the banks open accounts in and pay high rates of interest on this kind of "money." The amounts of the bills are credited to the depositor and check books issued, it being printed on the checks that they are payable in the bank's ninety-day sight bills on London. Telegraphic transfers, sight drafts, letters of credit, etc., on New York and even London, for large amounts, are usually paid for with ninety-day bills on London. It is really surprising how large a volume of business of the country is just as effectually done outside of it as if the

contracting parties had really gone abroad for the purpose. This point furnishes a wide field for reflection on the effect of such a system.

At the beginning of the latter half of 1916 the number of pence in the form of ninety-day sight bills on London which could be obtained for one peso gold began to increase rapidly and long before the end of the year it became cheaper to import sovereigns, which are legal tender in Chile, than to sell bills of exchange. Unfortunately, however, sovereigns were not obtainable until about the end of December and then only in small quantities. At this time the rate was approximately $19 \frac{5}{16}$ pence and since that has climbed steadily until it has reached 20, the gold point having advanced steadily through the increase in the cost of freight and insurance, especially since the United States broke off relations with Germany. It will no doubt occur to the reader that if sovereigns were not obtainable why was it not

NOYES & COMPANY

Established 1879

Foreign Bills

Government and Municipal Bonds

8, Place Edouard VII.

PARIS - FRANCE

feasible to import other gold and coin it. The reason lies in the fact that the freight rate on shipments of gold over the state railways between any two points in Chile, irrespective of the distance, is greater than it would be from any financial centre abroad to any port in the country; for instance, from Valparaiso to Santiago, where the mint is located, a distance of only 117 miles. That is to say that a lack of attention to the welfare of the country on the part of one of the branches of the government has kept the country from procuring a good stock of gold so necessary at all times and peculiarly so in war time.

Since sovereigns became obtainable the National City Bank, through its Chile branch, established in October, 1916, has imported gold steadily in as large a volume as circumstances would permit, it being so far the only bank in Chile to do so. As the stock of gold in the country was very small, these importations are having a noticeable effect. The volume and number of transactions in gold money are increasing, and there is a distinct tendency by many to get on a stable basis, this being accentuated by the fact that the level of purchasing power of *moneda corriente* is much higher than it has been for some time and the present is consequently considered by some as the right moment to convert. It would seem that conversion in Chile, like charity, should begin at home. The Govern-

ment has lately decreed that a portion of the export tax be payable in gold coin and the intention is to increase this proportion gradually. All steps taken whose effect will be to increase the use of gold as a circulating medium will be steps in the right direction and in accordance with the tendency of the times.

The inauguration after many years of a gold movement into a country which had so limited a stock of it as Chile had should necessarily have marked effects. The fact in itself curtailed the possibilities of getting a corner in it at once. More important, however, will be the stabilizing effect it will have on the purchasing power of paper money by making it possible to cover, and better still, avoid risks by operating in gold instead of in bills of exchange, thereby eliminating one of the principal causes of the fluctuations. It is to be hoped that conditions will continue to be favorable for importations of gold to the extent of forming an abundant stock of it in the country. In this way those who wish to eliminate speculation from their business may do so even if Congress fails to make the conversion law effective and gradually with the increase in the volume of business done in gold and consequent decrease in *moneda corriente*, the units of the two systems should circulate together at their real value, even eventually perhaps on a parity.

Liberty Trust Company

8, Place Edouard VII.

Total Resources Over

\$10,000,000

PARIS - FRANCE

The Union Bank of Manchester, Limited

Head Office
17 York St., Manchester, Eng.

Liverpool Office
45 Castle St., Liverpool, Eng.

and branches covering the whole of the district tributary to these two cities, and also WEST YORKSHIRE; including SHEFFIELD, BRADFORD, SALFORD, BIRKEN-HEAD, OLDHAM, BOLTON, BURY, ROCHDALE, STOCKPORT, HALIFAX (ENG.), HUDDERSFIELD, etc., etc.

	(\$5=£)
Nominal Capital	\$12,500,000
Paid-up Capital	2,750,000
Reserve Capital	3,500,000
Subscribed Capital	6,250,000
Reserves	1,903,470
Surplus over Liabilities	8,153,470

Bankers in the United States and Canada are invited to make use of the Bank's services for all kinds of banking business in the district where the Bank operates, and in Great Britain generally. Collections promptly dealt with, and proceeds remitted by draft or cable transfer on New York, or as desired. Favourable terms.

American Banks in Foreign Trade

By E. A. GRAFF

Manager Foreign Trade Department National City Bank, New York

ONE of the prime essentials in the expansion of a country's commerce abroad is adequate banking facilities. The experience of the older commercial nations has demonstrated that foreign branches of a parent institution located in the home country are the best instrumentalities to provide these facilities. It is perfectly obvious why this should be so. National self-interest, a natural concern for the development of home commerce and industry over that of any other country, is a motive that can be relied on by merchants of a nationality identical with that of their banking affiliate. A firm, native of the United States, would expect perfectly honorable and fair treatment from a foreign bank in a foreign market where that firm is engaged in

commerce, but if it were engaged in close competition with other firms who are citizens of the country, there would always be taken for granted the natural inclination these foreign banks would have to favor business houses of their own nationality. Foreign branch banks are the outposts of their commerce. The staffs of such banks are pioneers of the vital commercial interests of merchants at home. They will gather credit and trade information to be sent to the parent institution for distribution among its clients, and they will be active agents in discovering and developing commercial opportunities for the goods of their own country.

Another consideration that illustrates the desirability of using American branch banks abroad wherever possible

is the necessity of paying to foreign banks, when they are used, a commission that is an additional and unnecessary charge on the cost of financing shipments of goods. In the years before the great war, foreign bankers' commissions were very considerable items, estimated by some authorities at a cost of twenty or thirty million dollars to our international commerce. Besides the commissions that must be paid directly, there was the inconvenience of settling accounts through the medium of a foreign currency, sometimes involv-

ing two conversions. Settlements were usually made through London in pounds sterling. This meant a conversion from the currency of the foreign market to pounds sterling, and from pounds sterling to dollars. Of course the exchange bankers must make a profit, and all this must be carried as an added charge to doing business abroad. The lack of American banking facilities in the foreign field was a handicap that was keenly felt by American business in its competition for the world's markets.



Bank of British West Africa, Ltd.

ROBERT R. APPLEBY, New York Agent of the Bank of British West Africa, Ltd., has announced the statement of the accounts of the bank for the year ended March 31, 1917.

After providing for current charges, rebate, bad and doubtful debts, there remains a net profit of £64,750 15s. 6d., to which must be added £15,417 0s. 11d. brought forward from last year, making a total of £80,176 16s. 5d. Of this sum £14,000, being 3½ per cent. for the six months to end of September, has already been distributed in interim dividend, and the directors recommend the payment of a final dividend at the rate of 4½ per cent. for the second half-year, absorbing a further sum of £18,000, making the distribution for the year eight per cent., less income tax.

The directors have further applied £10,000 to writing down premises and furniture account, £5,000 to the staff fund, £5,000 to the bank's insurance fund, and they have added £10,000 to reserve. The balance of £18,176 16s. 5d. is carried forward.

An issue of 50,000 new shares, £4 called up, at the price of £5 10s. per share, was offered to shareholders in December, 1916, and of these, 40,000 shares were allotted during the financial year. These shares rank for dividend as from April 1, 1917. In accordance with the terms of the circular of-

fering the shares, the directors will dispose of the remaining 10,000 shares in such manner as they consider most beneficial to the bank. The premium received on the new shares issued has been added to the reserve fund. The investments held stand in the books of the bank at less than the market value as on March 31, 1917.

Notwithstanding the difficulties and interruptions caused by the war, the result of the year's operations is again satisfactory. Branches at Manchester and at Nsawam (Gold Coast), and the bank's own agency at New York, were opened during the financial year, and, since the close of that period, branches at Jos (Nigeria), at Fernando Po, and at Mazagan (Morocco) have been established.

Owing to his acceptance of high State office, Viscount Milner, G.C.B., G.C.M.G., retired from the board in December, 1916. The vacancy thus caused has been filled by the election of the Earl of Selborne, K.G., G.C.M.G., as a director and chairman of the board. Under the Articles of Association, Lord Selborne retires, but offers himself for re-election.

The directors retiring by rotation are: Mr. D. Q. Henriques, Mr. G. W. Neville and Sir Owen Philipps, K.C. M.G., M.P., who, being eligible, offer

THE BANK OF CHOSEN

Incorporated by Special Charter of Imperial Japanese Government

(¥0.50 — 1 Yen)

Subscribed Capital, Yen 20,000,000

Paid-Up Capital, Yen 12,500,000

Head Office, Seoul, Korea

Principal Branches:

KOREA: Chemulpo, Pyongyang, Wonsan, Fusan

MANCHURIA: Mukden, Dairen, Changchun, Newchwang, Harbin, Antung

JAPAN: Tokyo, Osaka, Kobe

Affiliated Bank:

EASTERN SIBERIA: Vladivostok-Matsuda Bank

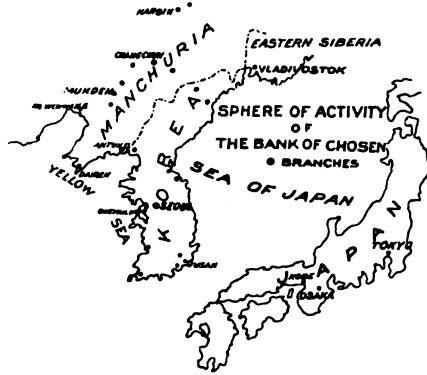

Principal American Correspondents:

Guaranty Trust Company of New York
Irving National Bank, New York
National City Bank of New York
National Bank of Commerce in New York

Yokohama Specie Bank, New York and San Francisco
Canadian Bank of Commerce, San Francisco and Seattle

themselves for re-election. The auditors of the bank, Messrs. Harmood Banner & Son, offer themselves for re-election.

The warrants for the final dividend for the year will be posted to the shareholders on July 11.



Commercial Bank of Italy Opens New York Branch

THE Commercial Bank of Italy (Banca Commerciale Italiana), whose head office is at Milan, will open a branch in New York under the management of G. Pedrazzini and John S. Durland. The bank has a capital of £6,240,000 and £2,388,000 reserve funds.

It is to be noted that this branch of the bank mentioned is not for war business, but that it is opened in recognition of the growing importance of New York as a world centre of finance, and with the special aim of still further

developing the already large trade between Italy and the United States.

The Banca Commerciale Italiana is one of the great European banks with a vast network of branches in Italy and has maintained an important branch in London for many years. Through its affiliated institution, the Banque Francaise et Italienne de l'Amerique du Sud, whose home office is in Paris, but which has long maintained a chain of branches in Brazil and the Argentine, this newest branch of the Banca Commerciale Italiana will be able to bring

an intimate knowledge of conditions in South America and a highly organized piece of international banking machinery into the service of American firms taking an interest in the commercial development of the Southern Continent.

This bank's well-known organization in Italy will permit the new branch to become a powerful aid in increasing the trade and strengthening commercial relations between the United States and Italy as well as furnishing another channel for business to flow into the hands of American financial institutions. This new and intimate relation between the two countries will no doubt at once give direct dollar exchange an opportunity to firmly establish itself in Italy and lire exchange an opportunity to do the same in the United States.

The managers of the new institu-

tion, G. Pedrazzini and John S. Durland, are men of many years' experience in international banking. Mr. Pedrazzini, after long service in various European institutions, is now manager of the Banca Italiana, which maintains a strong chain of branches in Peru, and will take up his new duties about the first of the year. Mr. Durland is now on the ground to begin the organization of the new branch.

Ludovico Toeplitz, representing the Banca Commerciale Italiana, has been in New York for some time in connection with this and other business. Mr. Toeplitz has been connected with the Banca Commerciale all his life and is now on his way back to Italy, after acting for some years as general manager for Brazil of the Banque Francaise et Italienne de l'Amerique du Sud.

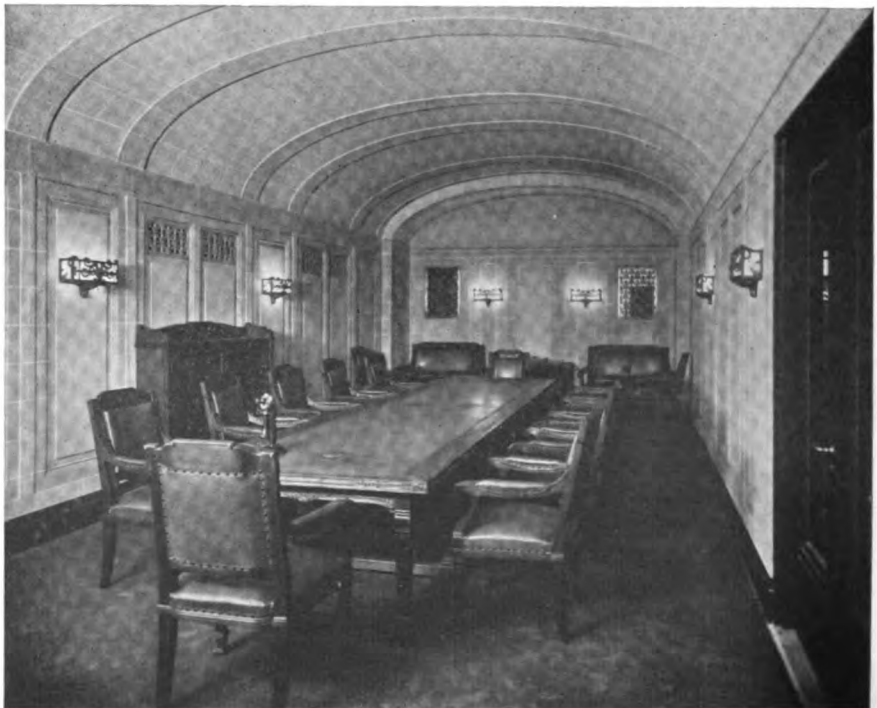

Board Room, Scandinavian Trust Company, 56 Broadway, New York

BANKAKTIEBOLAGET SÖDRA SVERIGE

Head Office: HELSINGBORG, Sweden

Branches: STOCKHOLM, GOTHENBURG, MALMÖ, BORÅS and in 48 other
Places in Sweden

(\$0.26 = 1 Kr.)
Capital Paid Up Kr. 30,000,000
Surplus About Kr. 15,000,000
Resources About Kr. 260,000,000

The organization and excellent relations of this Bank secure to its clients the most efficient handling of their business on moderate terms
Inquiries and applications for terms are cordially invited and will find prompt attention

Principal New York Correspondents { **The Mechanics & Metals National Bank**
The National City Bank of New York

To Investigate Industrial Conditions in South America

THE general agent of the American Steel Export Company, P. H. Tackaberry, sailed from New York last month for South America.

Mr. Tackaberry will cover a large portion of the Latin American countries,

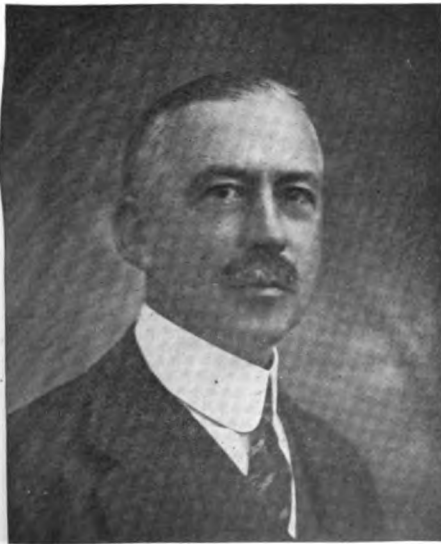

P. H. TACKABERRY

General Agent American Steel Export Company,
New York

visiting the following important cities: Rio de Janeiro, Sao Paulo, Buenos Aires, Montevideo, La Plata, Rosario, Valparaiso, Santiago, etc.

Primarily, the reason of Mr. Tacka-

berry's trip will be to collaborate with the company's various agents throughout South America, lending every possible aid and acquainting them more thoroughly with the facilities available at the home office, also the market conditions in this country for iron and steel and engineering and contracting.

Mr. Tackaberry will also call on some of the leading business men of these various cities, including the customers of the American Steel Export Company, for the purpose of obtaining any information that may ultimately result in mutual benefit in their export relations.



Half of Japan's New Loan to go for Railroad Work

FOR some time past the Japanese financial authorities have been in communication with the leading banks of the country with reference to the flotation of a new domestic loan for the current fiscal year, the Japan "Chronicle" says. On April 26 representatives of the Industrial Bank, Bank of Formosa, Bank of Korea, and the Mitsui, Mitsubishi, Daiichi, 115th, Daisan and Yasuda banks in Tokyo, and of the 34th, Omi, Yamaguchi, Naniwa, Kashima, Konoike and Sumitomo banks in Osaka met in conference with the financial authorities in the Bank of Japan rooms. An agreement was reached on the terms of the proposed loan.

The total amount of the loan is

40,000,000 yen (\$19,940,000), bearing interest at five per cent. per annum, the issue price being fixed at 95 yen (\$17.36). Redemption is to be made within fifteen years. Bonds will be issued in denominations of 50, 100, 1,000, 5,000 and 10,000 yen (\$24.92, \$49.85, \$498.50, \$2,492.50 and \$4,985). The subscription lists are open from May 2 to May 5, 1917. Subscriptions are accepted according to the amount of the issue price offered, acceptance or rejection to be decided on May 10. As reasons for the flotation of the loan, the Finance Department announcement gives the following data:

The financial conditions of the country continue favorable. From the beginning of the year to the middle of April exports from this country exceeded imports to the extent of \$68,793,000, while the excess of the inflow over the outflow of gold and silver bullion amounted to \$19,940,000. Judging by the present conditions, there will be enormous foreign accounts due to the country. If things were left to take their own course, exchange would become unfavorable, paper currency inflated, and the prices of commodities advanced, which would give rise to an increased speculative fever. It is therefore necessary to take some steps for the regulation of the money market.

The proposed issue of new Russian Treasury bills in this country has been postponed for the time being, and there are as yet no particular demands for money for silk and tea interests. Last year the Government, both to meet its own requirements and for the purpose of regulating the money market, provided in the budget for the flotation of a loan of \$9,970,000 for railway construction and of \$19,940,000 for reimbursement of the Treasury, this sum having been appropriated for railway undertakings. Though the budget was not passed on account of the dissolution of the Diet, the Government is in a position to carry out a part of the estimates, and has decided to raise a loan of 40,000,000 yen (\$19,940,000), of which half is to be used for railway improvement and half for the Treasury reimbursement.



London Bank of Australia Limited

THIS bank with an authorized capital of £2,886,067 has total resources of £7,601,955. Profits for the year ended December 31 last were as follows:

STATEMENT OF PROFITS FOR THE YEAR ENDED DECEMBER 31, 1916.

	£	s.	d.
Profit in London and in Australia after providing for interest due and accrued on current deposits, deducting rebate on bills, and making provision for bad and doubtful debts.....	220,389	18	2
Less—Salaries and general expenses in Australia, including remuneration to local directors, rent, rates, repairs, stationery, traveling, etc.....	101,402	15	1
Salaries and general expenses in London, including directors' and auditors' fees, rent, repairs, stationery, telegrams, etc.....	16,688	14	6
Land tax, income tax and tax on note issue....	33,010	2	8
	151,101	12	3
		69,288	5 11
Less—Interim dividends paid November 3, 1916.....	23,199	8	0
Grant to officers' provident fund.....	2,000	0	0
Dividends now proposed to be paid.....	23,199	11	6
		48,398	19 6
		20,889	6 5
Balance of undivided profit as per last report..	47,987	19	0
Less—Dividends for half-year ended December 31, 1915	23,196	13	9
		24,791	5 3
		45,680	11 8
Transfer to reserve fund.....		25,000	0 0
Balance carried forward.....		20,680	11 8

MERCANTILE BANKING COMPANY, Ltd.

Avenida Francisco I. Madero No. 12

CITY OF MEXICO, D. F.

Capital and Surplus, \$600,000.00

GEO. J. McCARTY, President K. M. VAN ZANDT, Jr., Vice-President and Manager H. C. HEAD, Cashier FCO. COUDURIER, Asst. Cashier

Members: American Bankers' Association, Texas Bankers' Association, Mexico City Clearing House

GENERAL BANKING TRANSACTED TELEGRAPHIC TRANSFERS

Foreign Exchange Unsurpassed Collection Facilities Throughout the Republic

SEND US YOUR MEXICO BUSINESS

WRITE US UPON ANY SUBJECT WHICH MAY BE OF INTEREST TO YOU IN THE REPUBLIC OF MEXICO. P. O. Address: Apartado 1344.

Exhibition of Bolivian Products

THE Consul General of Bolivia, in the United States, has announced that he has now on exhibition at the consulate, forty-first floor of the Woolworth building, a part of the minerals, rubber, precious woods and other native products of the Republic of Bolivia, that were shown at the late Panama-Pacific Exposition in San Francisco.

This exhibit will be maintained at the consulate as a permanent feature to aid in the dissemination of information regarding opportunities in Bolivia.

Bolivia is the third largest of the South American republics, has an area of 708,195 square miles, is the most thoroughly mineralized country on earth, has some of the finest rubber, cattle and agricultural lands that can be found anywhere; its climate is good and healthful and its laws are liberal and just to native and alien alike.



China's New Banking Law

CHINA has a new banking law. Among other things it provides that if the bank is a limited liability company it must have a capital of at least \$100,000, and if it is not, a capital of \$50,000; that no banknotes shall be issued without special legal permission; that a half-yearly return shall be published in connection with its busi-

ness transactions, and the ministry of finance shall have the right to inspect such reports; that with the exception of holidays banks shall never close on business days without special permission from the local authorities; that the ministry of finance from time to time shall appoint officials to audit the accounts and books of the bank; and that in case of bankruptcy and liquidation a detailed report of the circumstances shall be submitted to the ministry of finance.



Italian Banks to Have Branches in New York

IT is reported from Rome that several of Italy's largest banks have decided to open branch houses in New York, instead of relying upon American banks to represent them, as in the past.

The purpose of these banks is to compete for the handling of the large war business resulting from the purchases now being made by Italy in the United States, for the handling of the funds sent home by Italians and for the general tourist and trading business expected to come after the war.



Banca Italiana di Sconto

FOR the year ending December 31, 1916, the Banca Italiana di Sconto, whose head office is in Rome, Italy,

showed a net profit of L. 6,913,841.68 which has been appropriated as follows: Five per cent. to the legal reserve fund, L. 345,692.08; a four per cent. dividend on the capital stock, L. 2,800,000; for the remuneration of the administrative council, L. 301,451.96; a further two per cent. dividend on the capital stock, L. 1,400,000; added to the ordinary reserve, L. 2,154,307; carried over, L. 81,229.28.

Dividends were purposely limited in order to make a liberal appropriation to the reserve account—an action which the board considered wise at this time. The death of twenty-six employees, fallen on the field of battle, was reported.



The Bank of Adelaide

THE statement of the Bank of Adelaide as of March 26, 1917, shows total resources of £5,128,131 and total deposits of £3,759,455. The bank has a paid up capital of £500,000. The net profits for the year were £58,459, out of which dividends of £40,000 were paid during the year. The reserve fund on March 26 was £510,000.

The head office of this bank is in Adelaide, Australia. It has branches and agencies in all parts of South Australia.



Foreign Exchange Facilities in Venezuela

THE opening of a branch office by the Royal Bank of Canada in Maracaibo, Venezuela, will mean increased trade facilities with Maracaibo and the surrounding country for the United States.

Consul Emil Sauer reports that the branch will carry on a general banking business, but will be especially concerned with the business of foreign exchange.

The Mitsui Bank, Ltd., Tokyo

THIS bank, with a capital of Yen 20,000,000 and a reserve of Yen 8,400,000, has total assets of Yen 197,404,126. During the year ending December 31, 1916, net profits were Yen 2,238,350, out of which Yen 1,100,000 were appropriated to the reserve fund and Yen 500,000 was paid in dividends to shareholders.

The Mitsui Bank was founded in 1680 and is the oldest banking institution in Japan.



Appointed to Engineering Staff

ALL & COMPANY of Tokyo, the Japanese agents for the American Steel Export Company, have added B. Orum Andresen to their engineering staff. Mr. Andresen, prior to leaving for Japan, spent several days acquainting himself with the organization and the facilities the American Steel Export Company have for export engineering and contracting.



The Commercial Banking Company of Sydney, Ltd.

ACCORDING to the last statement of the Commercial Banking Company of Sydney, Limited, the total resources are £28,463,791, and deposits amount to £22,960,081. The bank has a capital of £2,000,000 and a reserve fund of £1,875,000 and a reserve capital of £2,000,000. The last dividend was at the rate of ten per cent.



New South American Branch for Boston Bank

ANEWS dispatch from Uruguay reports that a branch of the First National Bank of Boston was opened in Montevideo on July 16.

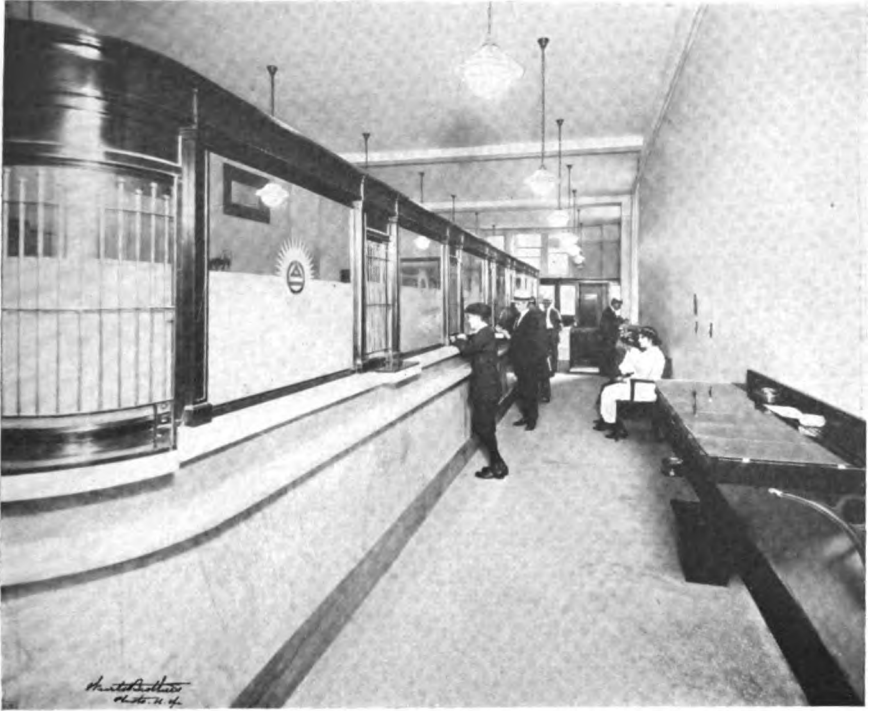

Main Banking Lobby, New York Agency, Bank of Taiwan, Ltd.

New York Agency of the Bank of Taiwan, Ltd.

THE changes brought about by the European War have greatly increased the importance of the commercial relations between Japan and the United States, resulting also in much closer banking and financial connections between the two countries. To provide for the adequate handling of the present large Japanese-American trade the leading banks in Japan are either enlarging their lists of American banking correspondents or establishing agencies in the United States. Of the latter class of activities may be mentioned the recent opening in New York of an agency of the Bank of Taiwan,

Ltd., under the management of Mr. K. I. Imanishi.

The head office of the Bank of Taiwan is at Taipeh, Taiwan (better known as Formosa). This institution was incorporated in Japan in 1899. Its subscribed capital is \$10,000,000, and the amount paid up \$8,750,000, besides which there is a reserve fund of \$3,000,000. In addition to the main office there are twelve branches in Taiwan as well as other branches at Kobe, Osaka, Tokyo and Yokohama, Japan; Amoy, Canton, Foochow, Hankow, Kiu-kiang, Shanghai, Hong Kong and Swatow, China; Singapore, Straits Settle-



Office of K. I. Imanishi, Manager New York Agency, Bank of Taiwan, Ltd.



Officers' Quarters, New York Agency, Bank of Taiwan, Ltd.

ment; Soerabaja, Java; Semarang, and London, England. In the last-named city its bankers are Parr's Bank, Ltd., the Capital and Counties Bank, Ltd., and the London and South-Western Bank, Ltd. The correspondents in New York are the National City Bank, Hanover National Bank, Irving National Bank, Guaranty Trust Company, Equitable Trust Company and National Bank of Commerce in New York.

The New York Agency of the Bank of Taiwan is in well-appointed offices in the City Investing Building, 165 Broadway, centrally located for banking and foreign trade. Mr. Imanishi, who is thoroughly conversant with the operations of finance and commerce between Japan and the United States, is assisted in the management of the New York Agency of the Bank of Taiwan by Mr. S. Mutoh and Mr. S. Kudoh.

The Bank of Taiwan is in all respects excellently equipped to supply to importers and exporters, in both countries, the facilities they may require in their business. Its size and strength, knowledge of conditions and extensive foreign and American connections, constitute a guaranty that this institution will render efficient service in this important field.



K. I. IMANISHI

Manager New York Agency, Bank of Taiwan, Ltd.

It is expected that the foreign trade of Japan during the current year will reach a total of \$1,000,000,000, and

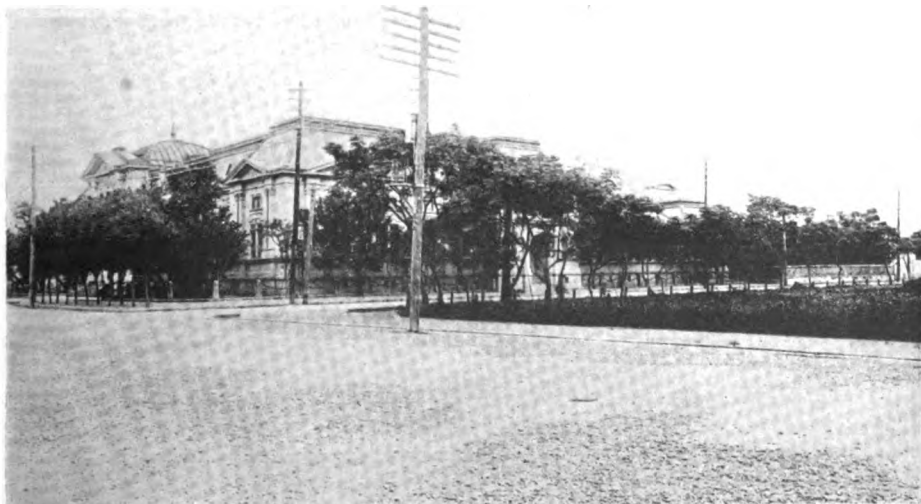

Head Office, Bank of Taiwan, Taipei, Japan



Bank of Taiwan, Tokyo Branch

that nearly or quite one-half of this will be with the United States. At present, owing to being practically cut off with communication with some parts of the world, Japan is importing more heavily than usual from the United States, while similar influences have operated to swell our imports from Japan. That country is now almost the sole source of our raw silk supplies, and that this trade is proving profitable to Japan may be inferred from the fact

that the price of raw silk is now practically the highest known for forty years, and 100 per cent. above the price recorded so recently as the year 1914.

As Japan and some other of the Far Eastern lands are at present less actively engaged in war than many of the Western nations, and since navigation is less dangerous on the Pacific than the Atlantic, trade between Japan and the United States may be expected to continue in extraordinary volume.





Organizers Philippine National Bank—From left to right: Leon Rosenthal, V. Singson Encarnacion, General Venacio Concepcion, Dr. H. Parker Willis, Samuel Ferguson, William H. Anderson, Charles C Robinson

Philippine National Bank

By H. PARKER WILLIS

[The "Journal of Political Economy" for May, 1917, contains an article by H. Parker Willis on The Philippine National Bank—an institution organized in 1916, by Mr. Willis, who made a visit to the Philippine Islands for that purpose. Below is given a condensation of the article in question.—Editor.]

THE Philippine National Bank is for the United States a new form of government activity in the business field, an attempt to dispose of certain pressing economic problems through organized effort, and a development of large interest in its influence upon the relations between the United States and the Philippine Islands. As an element in the colonial problem of the United States, as an instance of government enterprise, and as a special outgrowth of the peculiar conditions of trade brought about by the present European war, the bank is worthy of careful study and analysis.

Banking conditions in the Philippine Islands have long been of a somewhat peculiar character. American banking capital has never taken any deep root

there. Branches of the great English-oriental institutions—the Hongkong & Shanghai, and the Chartered Bank of India, Australia and China—have long exerted a dominating influence in the local banking field. The International Banking Corporation, organized under a Connecticut charter, established a branch in the Philippines some years ago and has enjoyed a share of insular business ever since. The Bank of the Philippine Islands, primarily owned and controlled by local interests, had been established for many years under Spanish domination, but upon assumption of American control was obliged to surrender many of its monopolistic features and to accept a new charter, which, however, gave it a valuable privilege of note issue. One or two Ameri-



DR. H. PARKER WILLIS
Organizer Philippine National Bank

can banks of small capitalization and unsuccessful management came into existence and speedily collapsed, after the taking over of the Islands by the United States.

In order to relieve this situation in some measure and to improve the general economic position of the Islands, the government has for several years past followed the plan of making loans from public funds for the purpose of facilitating the production of certain staple crops. This has gradually developed into a system whereby the bulk of the funds has gone to the sugar industry. There are several reasons for this development. First of all, the cultivation of sugar calls for large-scale enterprise and heavy investment. Payments to labor must be made in advance in many cases, and the outlay for machinery and transportation is larger perhaps than in any other field. The consequence has been that the negotiating of large loans by sugar-planters has

become an annual necessity for which the government has endeavored to provide. In order, moreover, to furnish permanent assistance in the development of agriculture, the Philippine government some years ago established an Agricultural Bank. This bank was provided with an initial capital of 1,000,000 pesos and it also had the use of funds which it received on deposit from provincial treasurers throughout the Islands. It made long loans to cultivators, but these all tended more and more toward the sugar industry. Thus government aid in mortgage banking, as in current assistance to agricultural interests, drifted toward the form of a special subsidy.

The question how to deal with the conditions growing out of the government's various financial undertakings and out of the failure on the part of existing banks to provide adequately for the necessities of the community was taken under advisement during the year 1915, and it was agreed that the best means of relieving the situation would probably be the adoption of an act providing for the creation of a strong banking institution under government control. A bill providing for such an institution was accordingly presented at the autumn meeting of the legislature in 1915 and was adopted, as already seen, on February 4, 1916.* In general, the new law provided for the creation of a bank with a capital of 20,000,000 pesos, or \$10,000,000 in gold, of which a little more than half, or 10,100,000 pesos, was to be owned by the government. The government's subscription to the stock of the institution was to be made in two forms: first, by the transfer of the assets of the older Agricultural Bank; secondly, by subscription of actual cash to the capital stock. The initial subscription was to be 1,000,000 pesos, and it was estimated that with the net assets of the Agricultural Bank this would result in providing a total paid capitalization at the outset of about 3,000,000 pesos. Sub-

*No. 2612, third Philippine Legislature, fourth session.

sequent subscriptions were to be paid by the government in July, 1916; January, 1917, and thereafter at annual intervals until the 10,100,000 pesos had been liquidated. The funds for this purpose were appropriated accordingly. It was further provided that the balance of the stock should be placed on the same basis and might be taken up by individuals, firms, or corporations as they might see fit, always provided that the government should at all times retain a majority control. The management of the bank was placed in the hands of seven directors, one of whom was to be a president, who should also act as chairman, and one vice-president. The first directors, of course, were necessarily to be appointed by the governor of the Islands, while subsequently a majority would be annually elected by the government, owing to its majority stock control.

The bank itself was authorized to do a very varied business. In order to meet the agricultural necessities of the Islands, it was allowed to loan upon long-term mortgage securities to an amount equal to one-half of its capital and surplus. It might then hypothecate the mortgages representing these loans and sell bonds against them, the proceeds of such bonds to be thereupon loaned to the public upon new real estate mortgages. On the commercial side the bank was authorized to do a general banking business, receiving deposits, opening foreign credits, and advancing money upon the usual kinds of security. Special provisions were introduced for the purpose of restricting the amount of loans that could be directly made upon single-name paper, while the limitation upon the margin of safety to be retained by the bank in lending upon stored or harvested products was severe. The bank was given power to erect and operate warehouses for the purpose of facilitating the storage of insular products, and either directly or by implication it was given authority to establish branches, rediscount bills, accept paper, and generally undertake every banking function. A



SAMUEL FERGUSON
President Philippine National Bank

limited note-issue power also was conceded to it.

It had been intended to open the Philippine National Bank upon a comparatively limited scale, gradually obtaining its personnel, and laying plans for the expansion of the institution upon a slow, systematic basis. Conditions, however, plainly indicated that such a course would not relieve the difficulties of the case. The bank had been technically incorporated on May 2,* and almost immediately upon its coming into existence it began to feel the urgent demands of persons who saw their resources in process of destruction or of transfer to others by reason of the policy which was being enforced against them by Great Britain. A review of the facts in the case furnished convincing evidence in support of the opinion that the bank must be organized at once

*The bank was organized on May 2 was controlled by a board of seven directors as follows: H. Parker Willis, chairman and president; Vicente Singson Encarnación, W. H. Anderson, Leon Rosenthal, V. Concepción, Teodoro R. Yangco, directors; and Samuel Ferguson, vice-president. Charles C. Robinson was appointed secretary of the bank with the rank of vice-president.



Staff of Employees Philippine National Bank, Manila, P. I.

upon as complete a basis as possible and must devote itself particularly to facilitating the movement of insular products to foreign countries in order, not only to meet the necessities of business men, but also to prevent the local farmer from suffering the loss to which he would be subjected through the narrowing of his market and the cutting down of his prices as the result of the limitation of the competition of buyers. The first step, however, was necessarily that of installing a definite accounting system and of taking over the cash and assets which had been provided for the new institution.

During the months of May, June, and the first half of July, the task of obtaining and drilling a small corps of bank employees was therefore taken in hand, and enough business was allowed to come into the bank even before it had obtained any permanent quarters, to put the staff through the exercises necessary to familiarize them with the work they were to undertake. Eventually about fifty employees were given

this preliminary training and appointed on a semi-permanent basis. As a more or less complete set of the essential books of account, forms, letters of credit, and other material had been brought from the United States, it was possible to begin the actual training of the staff without unnecessary delay, and thus to shorten an inevitably tedious process. The accounting system introduced had been devised with a view to the utmost simplicity and at the same time with the idea of permitting the use of the "block system" of proof in order that errors, if committed, might be detected before their influence had gone far. While the theory upon which this accounting system was based was by no means understood by the rank and file of the employees, it was possible to train them in the actual use of it on a rule-of-thumb basis, and to feel at the end of about two months a degree of certainty that they would be able to operate it successfully. Another problem was that of obtaining efficient tellers. None could be secured

who had had more than a very limited experience in the rapid counting and payment of money, so that an actual drill was necessary. Several men who had had good basic experience as cashiers, treasurers, etc., and who possessed the temperamental coolness necessary in this particular branch of bank duty, were selected and given an intensive schooling for a few weeks. The situation was somewhat more difficult because of the fact that, whereas in the Philippines all banking institutions differentiated between paying and receiving tellers, it was determined in the new bank that the tellers should both pay and receive because of the greater speed and convenience of this system.

A feature of the new bank which deserves special mention, although under ordinary circumstances no reference need be made to it, was that of the

physical equipment of the institution. It was, of course, impossible to purchase bank fixtures, grills, vaults, etc., in the Philippine Islands, while the unusual congestion on American railways, lack of tonnage facilities, and other obstacles would have prevented purchase in the United States even had the great length of time necessary for shipment not stood in the way. Immediately after the technical organization of the bank, therefore, it was decided to have everything manufactured in the Philippines. This involved the making of grillwork, banking screens, etc., by primitive hand methods, while all the furniture, fixtures, and equipment were prepared in the same way.

The statement of condition of the Philippine National Bank at the close of business, February 28, 1917, was as follows:

ASSETS.	PESOS.
Loans and discounts	14,990,573.38
Unmatured foreign bills	3,629,808.13
U. S. Government Bonds	500,000.00
Philippine Government Bonds	286,000.00
Furniture and fixtures	71,655.32
Interest Accrued receivable	410,960.49
Exchange for future delivery	2,804,060.40
Cash, viz..	
Due from branches	1,367,526.58
Due from banks and bankers	5,487,969.03
Due from foreign banks and bankers	14,786,982.99
In vault and with Treasurer of P. I.	15,756,278.78
Customers liability I./C.	37,398,757.38
	3,793,247.56
	63,885,062.66
LIABILITIES.	
Capital	6,229,870.00
Reserved fund	207,335.67
Profit and loss	108,005.42
Unearned discount	57,659.38
Reserved for taxes	20,000.00
Reserved for fidelity bonds	1,753.94
Circulation	520,000.00
Deposits:	
Insular government	34,143,529.06
Individual accounts	4,789,331.98
Due to banks	309,231.48
Due to branches	531,069.30
Secretary's checks	79,663.84
Dividend checks	2,034.55
Fixed deposits	10,761,777.15
Acceptances	50,616,637.36
Interest accrued payable	4,272.28
Exchange contracts	220,879.59
Letters of credit	2,804,060.40
	3,094,588.62
	63,885,062.66



Main Banking Room, Philippine National Bank, New York Agency

Out of the profits of the bank there was declared as of December 31, 1916, a dividend of eighteen per cent., one-half of which was paid to stockholders, while one-half was carried to reserve account.

The following table shows the growth in resources of the bank since its inauguration, May 2, 1916:

	PESOS.
On May 2, 1916.....	10,947,930.89
On July 22, 1916.....	31,414,861.79
On December 31, 1916.....	50,786,476.53
On February 28, 1917.....	63,885,062.66

A glance at the total resources on the different dates above mentioned will show that the growth has been very rapid. Such growth, however, has been of the most healthful kind and the officers have never at any time engaged in or permitted any speculation on the part of the bank, in foreign exchange or otherwise.

Almost at the outset of the bank's

entry into business transactions it was found that the banking situation as a whole presented certain serious obstacles. Perhaps the most important of these lay in the fact that the other banks of the city had established a combination agreement whereby they regulated or controlled rates of interest and foreign exchange. The rate at which the government stood ready to furnish exchange on New York, namely, three-fourths of one per cent. for mail transfers and $1\frac{1}{4}$ per cent. for cable, was normally regarded as constituting a minimum, and rates ranged distinctly above these figures practically constantly.

From the start sales of foreign exchange were made by the new bank at commercial rates varying daily in accordance with cable quotations obtained from abroad. The result was to effect a great saving to the community in exchange, but the situation proved more and more unacceptable to the other



Manager's Office, Philippine National Bank, New York Agency

banks because of the reduction in their earnings necessarily resulting from the fact that a competitive exchange market governed by prevailing rates had been established.

Very early in the process of organizing the Philippine National Bank the announcement was officially and positively made that the bank was a strictly neutral enterprise; that its managers were not interested in, and not affected by, the orders of any foreign government or the "Black List" prepared by any; that the loans of the bank would be made after due examination of the solvency and reliability of the borrower and without any reference to his political or religious status. The policy was a new one in the Philippine Islands, but the result was helpful to many individuals.

It was believed that the existence of the unusual conditions in the market and the very great necessity of the community for banking accommodation held out an unexpected opportunity to reform some existing banking practices. In the Orient to-day credit is largely

extended on the basis either of personal responsibility or of actual pledge of property. Either the banker trusts his customer or he does not. If he does trust him, because he is a good fellow or has valuable connections "at home," he hesitates to ask for a statement of the borrower's condition. He relies upon the gentlemanly instincts of the borrower in not asking more than he is entitled to, and, having formed his own opinion on the latter subject, opens his facilities to the borrower accordingly. If the banker does not trust the borrower, he insists upon an actual pledge of property. The Philippine National Bank from the beginning felt the duty of improving so far as possible existing practices in borrowing, and it therefore endeavored to obtain from each borrower a complete "statement of condition" upon a modern form. It was necessary to encounter very strong prejudices against the furnishing of any such information, and not infrequently desirable business was rejected because of the point-blank refusal of the borrower to comply with the re-

quest for a statement. In other cases, where the borrower was sufficiently ready to answer the questions carried on the statement, his books were of so elementary or crude a nature that he could not make a satisfactory reply. It was necessary to secure the aid of auditing concerns in reviewing and improving books, and in this way at least a useful beginning was made toward the introduction of better business methods on the accounting side. The bank also endeavored to obtain the introduction of better methods of warehousing and pledging staple products under a uniform warehouse receipt, and while thus far no distinct progress in that particular has been accomplished, a foundation of effort has been laid upon which valuable results may be developed at a later date.

From what has been said it will be seen that the work of the Philippine National Bank has already been of material service to insular interests and to the average man throughout the Philippine Islands at a time of great emergency when some heroic remedy had to be quickly applied if the economic interests of the country were to be saved from disaster. The rendering of such special service is not a title to the permanent continuance of any institution. It will, however, be evident to those who have carefully considered the circumstances which led to the organization of the bank that there is an economic reason for its existence and that it may become, not merely a money-making institution, but an agency equipped for the performance of important governmental functions and for advancing the interests of the community generally. It has, of course, and will probably continue to have, the duty of keeping the currency of the Philippine Islands interchangeable, at a reasonable rate, with that of the United States. It has the function of safekeeping and transmitting funds from all parts of the Islands to other parts on behalf of the government and of individuals. It has through its provincial agencies an important duty as the recipient and conservator of the funds of the people. Important as

these functions are, however, they are not the largest or most significant responsibilities which rest upon the bank. Fundamentally the institution is called upon to provide a direct and economical channel of communication between the insular investment and financial market and that of the United States. As will have been inferred from what has been said, the interest rates of the Philippines are excessively high, the supply of capital is scanty, and the means for promoting and developing industry are limited in the extreme. The methods of lending, the types of commercial paper already prevailing, the accounting and business methods employed by many firms, are unsatisfactory and need improvement if the community is to succeed in getting the advantage of more abundant and cheaper accommodation. To tone up in this way the business practice of the community and thereby to encourage the investment of capital in the Islands as well as to give the insular merchant immediate access at reasonable rates to the funds needed to carry his products and deliver them in their ultimate market is the most direct duty of the bank when viewed from the larger standpoint.

There is another problem connected with the Philippine National Bank whose gradual evolution will be watched with profound interest by those who are desirous to see steady and successful progress in the Philippines. This is the question whether the bank can maintain itself absolutely free of political interference or control. It is this rock of "politics" upon which many financial institutions in the Latin-American countries have split. They have found themselves under pressure to make loans and to engage in operations that were manifestly unwise from a banking standpoint, or they have been compelled by legislation to release their funds for uneconomical purposes, with resultant disaster. Americans will watch with interest the progress of the Philippine National Bank to see whether the Islands, with their new democratic form of government, can successfully resist this temptation.

Banking and Financial Industry

SPECIAL

The BANKERS
MAGAZINE

SECTION

IT is the aim of this department to make better known to each other the progressive banking and industrial institutions of the country.

This Magazine believes that by industry and economy, and by co-operation between all interests and sections of the country, the prosperity and happiness of the people of the United States may be advanced more rapidly, and to a greater extent, in the years lying immediately before us, than at any other time in the country's history.

How often the banker feels the desire and necessity for "getting out on the road" and making a grand tour of the banks of the country so as to get in touch with his contemporaries and broaden his outlook. Unfortunately, such an undertaking is generally impossible.

This Department seeks to take the place of such a trip by presenting to its readers instructive articles about banks and industrial institutions.

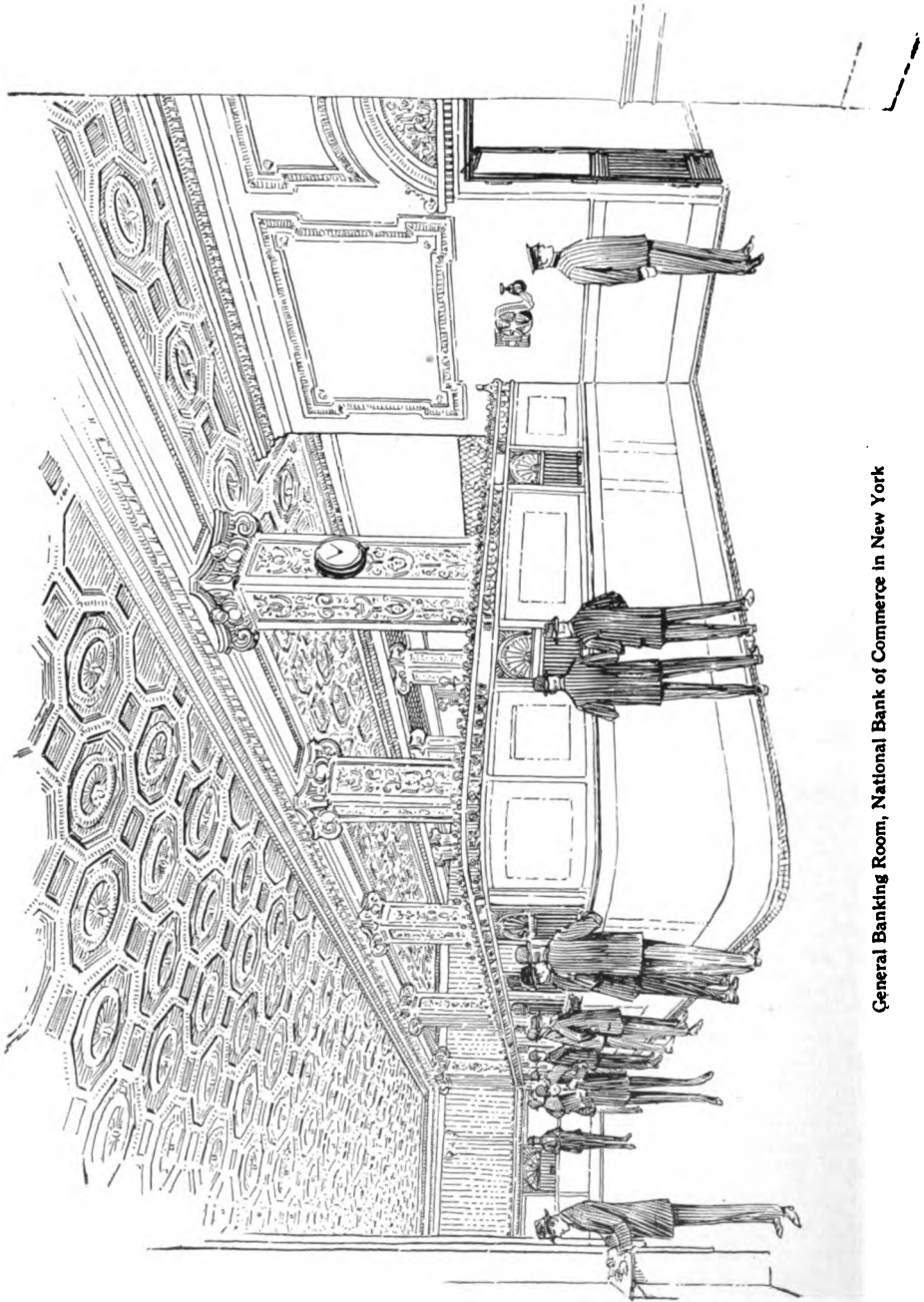

General Banking Room, National Bank of Commerce in New York



A Great American Commercial Bank

WITH the declared object of making people better acquainted with its history, facilities and its personnel, the National Bank of Commerce in New York has published an attractive illustrated account of the institution in pamphlet form. In the "foreword" of this interesting history, it is said:

"When you meet a man, his personal-ity interests you first of all. You depend upon further acquaintance to give you a knowledge of his technical ability and equipment. The same principle applies to a bank. We want you to realize that the National Bank of Commerce in New York has a definite personality. The bank does not and



Bank of Commerce in 1855

This Picture, reproduced from a contemporary photograph, shows the corner of Cedar and Nassau Streets as it looked in 1855. The four-story marble building was one of the finest then standing in the city. This was the home of the Bank during the trying days of the Civil War.

will not offer mechanically efficient service alone. It offers to its customers the prestige of vast financial strength, national and international in scope, combined with the warmth and

imagination of personal banking service."

Here is the modern banking idea, and the highly successful way in which it is being worked out by one of

the very large banks of the United States will be of such general interest that THE BANKERS MAGAZINE takes great pleasure in reproducing the main points of this experience.

HISTORY OF THE BANK

A bank must always be closely linked with the development of the community in which it does business. It is inconceivable that the right sort of bank should be prosperous when the community which it serves is unprosperous.

The whole history of the development of the Bank of Commerce in New York is a remarkable illustration of this principle. The growth of the city and the nation has helped the bank, but the bank has been able to do its part in increasing the prosperity not only of the city and state, but also, in many notable instances, of the nation itself.

The bank was founded in 1839 during that period of severe business depression which followed the panic of 1837. The federal charter of the Bank of the United States had expired a year before the panic and many prominent citizens of New York believed that an institution of large capital was demanded.

Consequently, the Bank of Commerce was founded with a capital stock of \$5,000,000. The articles of association were drawn up by the famous lawyer, Chancellor James Kent, who became a member of the original board. The eighteen original associates included twelve prominent merchants, two lawyers, two men of affairs and two bankers.

The names of these merchants are closely linked with the inspiring period of American commerce which was then at its height, names such as Gracie, Minturn, Carow, Donaldson, Sturges, Whitney, Stevens and Russell. Their industry had helped to send our merchant marine to all quarters of the globe, initiated American trade enterprise in China, and carried our commerce to the Pacific Coast and to the ports of the Orient.

The first president of the bank was

Samuel Ward of Rhode Island of the famous old firm of merchant bankers, Prime, Ward and King. He was the father of Julia Ward Howe, who wrote "The Battle Hymn of the Republic."

CO-OPERATION WITH THE GOVERNMENT

In its early years the bank worked very closely with the Federal Government, in May, 1840, \$500,000 in Treasury notes was purchased and placed to the credit of disbursing officers of the War Department. In August of the same year, the bank subscribed to \$1,000,000 of United States bonds at par and was made the agent for public moneys collected in New York. This relationship lasted until the Independent Treasury system was adopted.

When the Clearing House Association was organized in 1853 the Bank of Commerce was one of the original members.

Four years later came the panic of 1857. The Bank of Commerce took the lead in endeavoring to prevent the suspension of specie payments. When resumption seemed possible the Bank of Commerce called a meeting of the leading banks of New York and was able to arrange with three other banks to resume payments. This courageous step was shortly followed by the other banks.

CIVIL WAR FINANCING

During the Civil War the Bank of Commerce was able to perform a unique service. In December 1860, the Secretary of the Treasury had asked for subscriptions for \$5,000,000 in Treasury notes, but less than half that sum had been bid for, and some bids were as high as thirty-six per cent. A default seemed probable when the Bank of Commerce came forward and took the entire issue of \$5,000,000 at twelve per cent. During the early part of 1861 the condition of the Federal Treasury was desperate. The expenses of the war amounted to approximately \$1,000,000 a day. John A. Stevens was then president of the bank and under

his leadership a committee of bankers was formed and a bond issue floated which met the immediate needs of the situation.

In 1864 the National Bank Act was passed. The Government was desirous of having the Bank of Commerce take

loans to a successful conclusion and in rendering services alike to the nation and to the State of New York.

GROWING UP WITH THE CITY AND NATION

After this period the bank grew rapidly. The wealth and the population



Main Staircase, National Bank of Commerce in New York

out a charter because of the strength of the institution and the value of the example thus set.

Throughout the entire course of the Civil War period the Bank of Commerce took a leading part in bringing

of the city increased by leaps and bounds and the strength of the National Bank of Commerce kept pace with its opportunities and obligations. With the great expansion of the West the business of the bank began to reach

out into all corners of the country, laying the foundations for the national position which it is now occupying and will increasingly occupy in the coming years.

In 1893 the late J. Pierpont Morgan was elected a vice-president and held that position until 1904. In 1900 the bank merged with the National Union Bank and in 1903 with the Western National Bank of the City of New York which had been founded in 1887 by Daniel Manning, Secretary of the Treasury under President Cleveland.

The bank's statement of May 1, 1917, showed a capital, surplus and undivided profits of over \$44,000,000 and deposits amounting to \$338,000,000. During the past year deposits and withdrawals from the bank amounted to nearly \$38,500,000,000.

The officers of the bank are thinking along the national and international lines which the great future of this country demands. The hundreds of employees are unsurpassed in their efficiency and loyalty to the institution. There are employees in the bank who have rendered skilled and faithful service for more than thirty-five years. New men are being drawn from all parts of the country and from the schools and colleges of the nation.

The officers have come from all sections of the country and are in close contact with the commercial and industrial problems which the banker and the business man must work out together in order to place this nation in the commanding position it is destined to occupy in the world's commerce of the future.

NEW YORK ACCOUNTS

The bank makes a specialty of large accounts because it does not believe in taking away from other industrial centres business which properly belongs to them. At the same time it offers both to large concerns, and to smaller concerns which actually need a New York connection, strength and facilities which are unsurpassed.

A bank can only grow as the com-

munity in which it does business grows. The National Bank of Commerce has always been closely associated with the development of the city of New York, but at the present time it is in every sense a great national bank and its interest is in the development of the larger community, namely, the United States, over which its business now extends. The steadily increasing prosperity of every section of the country means the steadily increasing prosperity of this great bank located in the financial and export centre of the nation.

There are forty-three separate service divisions in the bank. They are all working for a single object, namely, to render a powerful and well balanced banking service.

SOUND CREDIT EQUIPMENT

The National Bank of Commerce was among the first commercial banks to start a regularly organized, well equipped and highly specialized credit department.

To-day there are in the credit department between 30,000 and 35,000 files containing up-to-date information with regard to manufacturers and merchants. Thousands of credit inquiries a year are received from correspondents all over the United States and Europe.

The department is called upon every day for advice not only by purchasers of negotiable paper, but also by actual sellers of merchandise.

The officers of the bank having been drawn from various lines of industry and different sections of the country, are in a position to administer this service in a broad and foresighted manner.

FOREIGN DEPARTMENT

The foreign department is also extremely efficient in the quality of its service.

The officers of the bank are particularly interested in the development of foreign commerce because they realize the vital importance of foreign trade

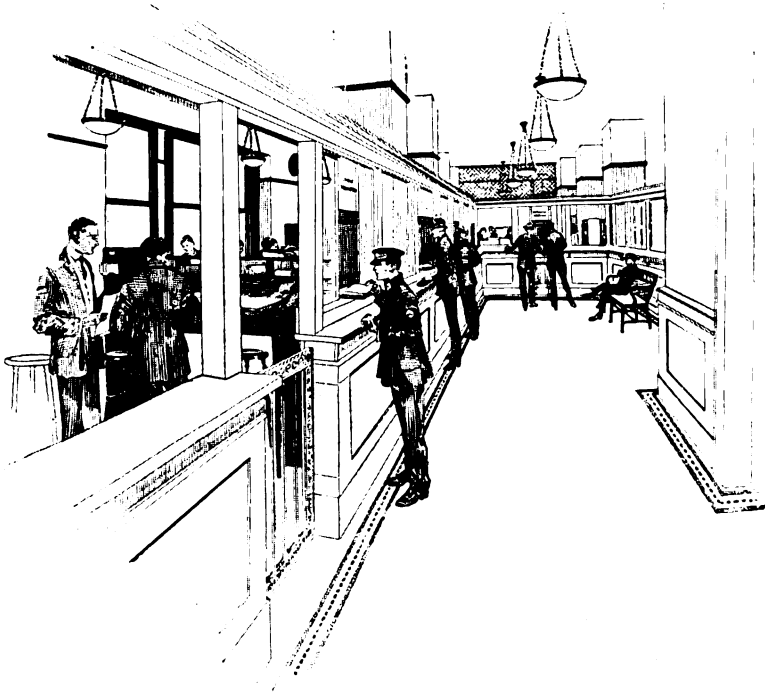

Foreign Department, National Bank of Commerce in New York

in the future of the United States.

The foreign department facilitates import and export financing by issuing commercial letters of credit, and negotiating acceptances and bills of exchange for American manufacturers and merchants doing business in all parts of the world.

The statement of the National Bank of Commerce in New York, issued on the call of May 1, 1917, showed outstanding \$26,912,426.24 for letters of credit and acceptances based on imports and exports. This total sufficiently indicates the extent to which the foreign service is being availed of.

The statement on the call of July 20, 1914, showed letters of credit of acceptances amounting to \$1,229,612.39. This was the first statement on which the item appeared after the Federal Reserve Act opened this field for national banks.

The foreign department is prepared to assist customers in a practical way in establishing agencies abroad, and

in making foreign connections that should develop into profitable accounts. This bank was one of the pioneers in South American fields and its connections in that country are particularly close.

A National Bank of Commerce commission, headed by a vice-president and including an assistant cashier, has left for an extended business trip through Russia and other countries where the bank has recently carried on extensive transactions.

SERVICE DEPARTMENT

In line with the traditional policy of the National Bank of Commerce a department is in operation under the direction of a vice-president, and including an assistant cashier and other expert assistants called the service department.

It is not an isolated part of the bank work, but a cross-section of it. It aims to supplement the business service

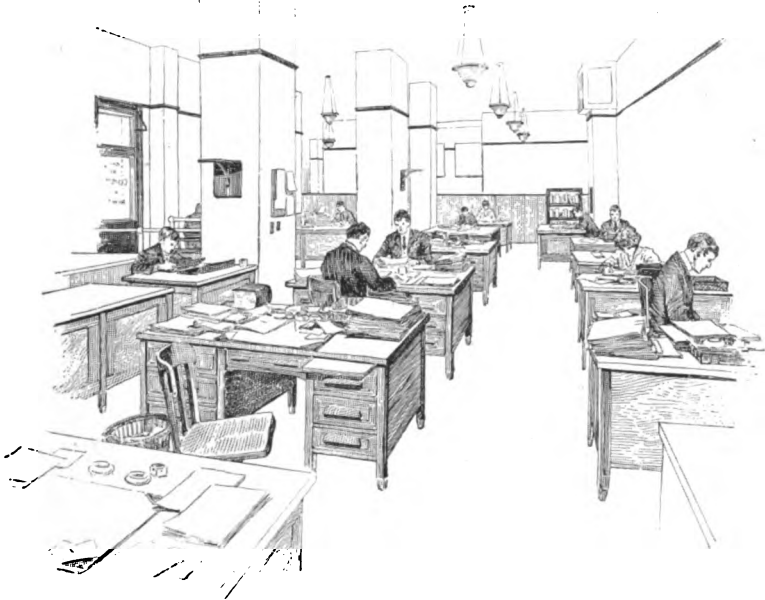

Credit Department, National Bank of Commerce in New York

which the bank renders through its various departments. Studies are made of various lines of business in their broader aspects both here and abroad with a view to developing an attitude toward the accounts of customers in particular lines of business which is not possible in the ordinary routine.

THE BANK AND ITS EMPLOYEES

The National Bank of Commerce in New York has adopted a policy of thorough education of its employees along the most advanced lines. For a long time the bank has believed that such a policy is becoming necessary to keep pace with the steady and consistent growth of the institution and the consequent rapid increase in its demands for the highest grade of service.

The educational scheme outlined involves elementary courses in economics and banking which will give the beginners a broader view of what they are doing. More advanced courses will be formed for the men who show promise in the elementary courses and it is

planned to make the advanced courses the most thorough and practical of their kind.

It is a problem of human resources. It is becoming increasingly obvious to employers of large units of labor that the human resources are at least as important as the financial resources.

The National Bank of Commerce has adopted a policy which involves a systematic search of all sources of supply for the best available men. After the men have been employed they are carefully developed through their entire course in the bank. In this way alone is the bank able to meet the constantly increasing demands which are being made on it for the very highest class of service in all departments. And it should be emphasized that by service is meant not merely routine service. What is called for is the man with imagination, with original ideas and with the ability to carry those ideas into effect without constant supervision from above.

The economic position of the United States in the future is going to depend very largely upon the breadth of vision



Officers' Room, National Bank of Commerce In New York

of the men who are in charge of her financial and industrial affairs. And it will not be enough for a few leaders to be men of vision. The world spirit must permeate the whole structure. There must be coöperation and team work in every department of business.

The commerce club of the National Bank of Commerce is made up of nearly five hundred employees of the bank. It has as its object the broadest possible development of its members and the fullest coöperation among them for their own interests and for the interests of the bank. In preparation for this it has undertaken to demonstrate its immediate usefulness among its membership by the establishment of thrift and welfare committees, an entertainment committee and other features of service. The "Commerce Monthly" is published by the members of the Commerce Club. It is their official organ. It contains articles on banking and other subjects of an educational character.

A system of coöperative buying has been in operation for some time which enables the members of the club to obtain their food at a considerably re-

duced cost provided it is purchased at the same time with the general supplies of the bank. These supplies are procured in large quantities to meet the needs of the dining-room, where meals are served the employees of the bank at various times during the day and night. This custom has been in force since 1866. Upwards of six hundred meals are served during each twenty-four hours. The eating quarters command a view which of its kind is unsurpassed anywhere in the world.

The scheme of coöperation is still in its infancy, but has shown that groceries, clothes and other materials can be obtained at a reduction of from ten to forty per cent. through wholesale buying under the supervision of the bank. The success of the plan has led to consideration of a coöperative store in which the employees are to be stockholders.

The thrift committee receives deposits ranging from \$1 to \$1,000 a year. No depositor is permitted to carry a balance of more than \$3,000. The rate of interest is determined by the thrift committee and is based upon the amount earned during the period, after

setting aside for a contingent fund an amount equal to five per cent. of the earnings. This amount is set aside until the fund equals five per cent. of the deposits.

The bank has established a pension scheme as well as a system of disability and life insurance for all employees, the premiums on which are carried by the bank.

These activities are an outgrowth of the general policy of the bank to cooperate with its employees in all particulars.

SIZE AND SERVICE

Personal service may seem to imply limitations as to size. A single individual cannot be in close personal relationship with thousands of people. The small country banker will always know more about the personality of many of his depositors than can the officer of a great metropolitan bank. The story of

the service rendered by the small banker as counsellor and advisor in his community would form one of the most interesting chapters in the romantic history of banking. The small bank will always be needed.

The need for powerful financial service, however, has developed with the tremendous growth of the units of modern business. American skill and industry have built up in all parts of the country vast organizations doing a national and international business which demands credit facilities beyond the power of small banks to supply. This need has been met by the development of great institutions like the National Bank of Commerce in New York which supplies the vast lines of credit needed by large or growing industries while at the same time preserving with utmost care the personal touch which is absolutely necessary in connection with transactions large or small.

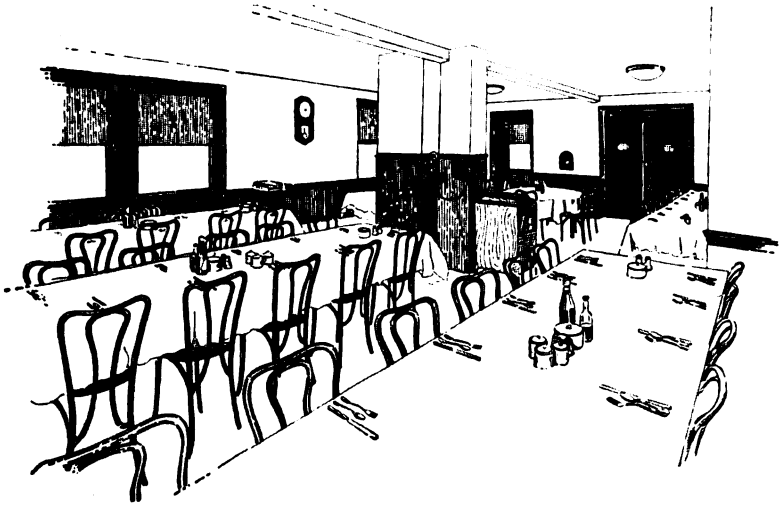

Section of Dining Room, National Bank of Commerce in New York



C. B. McELHANY
VICE-PRESIDENT



K. ORBANOWSKI
TREASURER

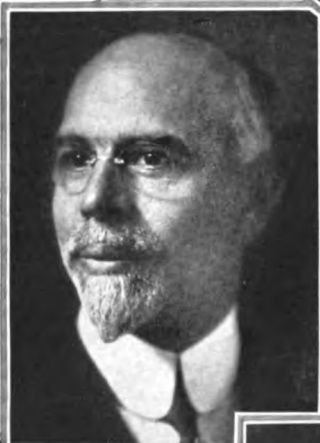

H. W. McATEER
PRESIDENT



J. P. BEAL
SECRETARY



S. A. BENNER
GENERAL MANAGER OF SALES

Officers American Steel Export Company, New York

Utility of Letters of Credit in the Export Trade—A Plea for Standard Forms

By J. P. BEAL

The American Steel Export Company typifies to a remarkable degree the extraordinary development in the export trade of this country that has come about within the last three years. While almost every branch of industry has been stimulated and extraordinarily expanded by the foreign demands coincident with the war, it has been the products of America's steel mills that have loomed up in so gigantic a manner in our export statistics. As even in normal times the financial needs and activities of the steel-producing plants have engaged the close and constant attention of American banking interests, the new overseas operations have brought daily to the fore problems demanding instant and safe solution.

This is the age of specialization and the American Steel Export Company has brought to bear all its resources and energies upon one particular phase of American export trade—the handling of steel and metal products and engineering equipment of every type. By ability and effort of a high degree it has become within a short space of time the second largest exporter of these manufactures in the United States. It has taken full advantage of the opportunities,—in foreign trade,—presented on account of the great "European Conflict" and stands to-day equipped to handle any question of Asian, European, South American or African use of metal products of a thousand different sorts.

The company is fortunate in having as its president a man of singularly acute vision in directing the financial policy of the organization, and he has been careful to surround himself with lieutenants having not only a full knowledge of modern American business methods but familiar as well with foreign banking, credit, and accountancy. This man is Mr. H. W. McAteer, formerly comptroller of the Cambria Steel Company. To his constructive genius is very largely due the extremely strong condition of the American Steel Export Company and its establishment upon foundations that will enable it to weather the storms that will inevitably assail us for a time when the war ends.

This article has been prepared by Mr. John P. Beal, secretary and assistant treasurer of the company, with Mr. McAteer's approval and collaboration. The author speaks with authority, for he has, since the inception of the company, handled millions of dollars' worth of business between the producers in this country and consumers all over the world, many of them thousands of miles away. Some of the difficulties of satisfactorily completing negotiations, involving as they do many intricate details, may be appreciated when it is realized that this work is carried on between men differing in race, language and customs.

The recommendations made by Mr. Beal in this article should be heeded by the American banker, for there is indicated a point of weakness which might be materially improved to the betterment and gain of our entire overseas financial fabric. He has chosen the one point which seems to him as worthy of immediate attention and has developed it fully and exhaustively, and has indelibly impressed upon our minds the modern theory of the letter of credit. *THE BANKERS MAGAZINE* considers itself fortunate in being the medium through which the various factors in American export trade may be brought together by means of such articles as this. It is in this way, through full coöperation and a complete understanding, that the American producer and foreign consumer may be linked together financially through such organizations as the American Steel Export Company.

DURING the past three years, since the outbreak of the European conflict, the demand for the products of the United States has grown to tremendous proportions.

Prices have pyramided in all classes of commodities and production has been stimulated to a point never before anticipated. The demand for our products

has not been from any one source or restricted territory, but from all parts of the world—and from people of whose financial standing we could not have any knowledge, nor could we have the time (so urgent is the need of the foreign buyer) to investigate their standing even had we the facility to do so.

It is not strange, therefore, that the



Office of the President, H. W. McAteer, American Steel Export Company, New York, N. Y.



Office of Vice-President, C. B. McElhany, American Steel Export Company, New York, N. Y.



Office of Treasurer, K. Orbanowski, American Steel Export Company, New York, N. Y.

use of the commercial bankers' letters of credit has developed at the same time in somewhat like proportions.

For those who may not be familiar with the principle of commercial bankers' letters of credit, it will probably be sufficient to give this explanation:

The foreign buyer, in whatever out-of-the-way place he may be, if he possesses the usual requisites for credit foundation can go to his bankers in his home town (the man who is logically the one to understand best the credit responsibility of the buyer) and arrange through him to open (through a single correspondent or series of correspondents—in the same manner as a check would be cashed) a banker's letter of credit in favor of the American merchant, which would enable the latter to obtain not only payment for his merchandise in this country, but also the assurance when the order is taken, that the money will be available when the merchandise is ready and in accordance with the order.

In this article, the writer does not

wish to dwell on the relationship of the letter of credit to export business nor the ethics of letter of credit transactions between banks. The principal thought is to present some of the experiences of a practical exporting house, dealing in letter of credit transactions daily, and to set forth some of the difficulties and suggestions in regard to such transactions as have presented themselves in the recent past.

There are two kinds of credits; first, the confirmed credit, or one which is irrevocable for a given length of time, and second, the unconfirmed credit, which is subject to cancellation by the maker at any time prior to the withdrawal of the funds by the payee. It is in regard to the former class of credits that this article is directed.

In these exceptional times, when prices are much above normal and no one is able to foresee just when the market may drop, the exporter, who is doing business with people with whose credit he is not very closely acquainted, must protect himself by securing from



Office of the Secretary, J. P. Beal, American Steel Export Company, New York, N. Y.

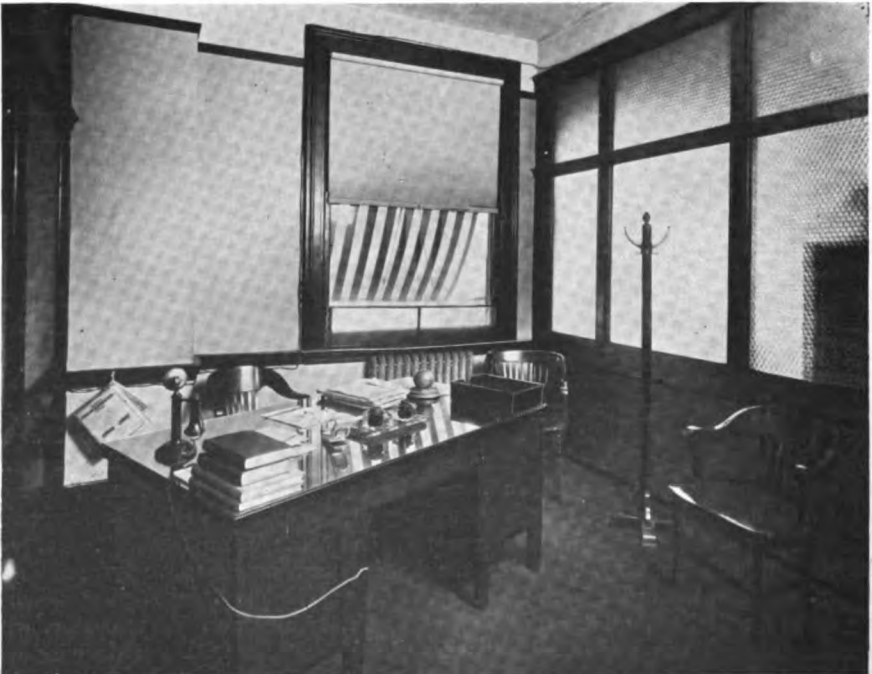

Office of General Manager of Sales, S. A. Benner, American Steel Export Company, New York, N. Y.



Office of Manager of Agencies, E. W. Ames, American Steel Export Company, New York, N. Y.

his foreign clients definite assurance that when the goods ordered are ready, the money will be forthcoming. He must make sure, not only that his customer has the money to pay, but probably the more important fact—that there will be no cancellation by the customer—providing the goods are delivered on time. For this assurance nothing is so adequate as an irrevocable letter of credit, established with a reputable bank.

VALUE OF STANDARDIZED FORMS

When the letter of credit has been established the exporter is then desirous of knowing that the terms of it are such as to give him adequate protection. In this regard it is interesting to note the many different forms used by the various banks; they all seem to be different in some respects. Some banks merely write an explanatory letter on their regular letterheads, while others have forms set up on which to record the various points in relation to the terms of the credit. When one considers the vast number of these daily transactions by all the banks having foreign departments or foreign correspondents of any

importance, it would only seem natural that some concerted action be taken by the banks to standardize, as much as possible, the forms for reporting letters of credit. Checks, drafts and notes have been standardized on uniform lines—why not letters of credit? The uniform bills of lading adopted by the railroads of the country have materially assisted both the shippers and the carriers in a more thorough understanding of the conditions and protection afforded to each.

There are always certain points in regard to a letter of credit about which the export merchant is vitally concerned, and if the letter from the bank does not clearly specify some of these it means correspondence between the two to clarify the point in question. This correspondence takes a considerable amount of time both of the merchant and the force of the bank. A great portion of it might be eliminated with an increase of efficiency and reduction of expense to both. Would these points not usually be more fully and clearly stated—and be more susceptible of proper interpretation, if standard forms were adopted?

There are seven points of primary



Engineering and Contracting Department, American Steel Export Company, New York, N. Y.



Stenographic Department, American Steel Export Company, New York, N. Y.



Showing the Cable and Traffic Department, American Steel Export Company, New York, N. Y.



Office of the Chief Engineer, G. A. Harris, American Steel Export Company, New York, N. Y.

importance in the letter of credit, as follows:

1. Drawn in favor of.
2. Whether irrevocable or unconfirmed.
3. For whose account issued.
4. Amount of credit.
5. Material to be furnished; kind; quantity; price per unit and delivery point.
6. Documents required.
7. Expiration date.

First—Drawn in Favor of: This point is usually without question, as the letter is always addressed to the payee and this is hardly susceptible of misinterpretation.

Second—Whether Irrevocable or Unconfirmed: This is usually of vital importance to the merchant and frequently not clearly stated by the letter whether the credit advised is subject to cancellation or not. Naturally, if the price at which the merchandise has been sold is higher than the normal market price, and the exporter has entered into con-

tracts for raw materials or with the manufacturers for the finished product, he wants to know that the credit on which he has based his sale is not subject to cancellation, prior to a given time.

A great many credits have been issued with this point not clearly defined, necessitating considerable correspondence to verify that the credits in question were not subject to cancellation. If standard forms were adopted, similar to those now in use by some of the prominent bankers, this point might be clarified by having the words "Irrevocable Letter of Credit" placed on the form at some conspicuous place, preferably at the head of the letter.

Third—For Whose Account Issued: It is quite essential that the name of the party opening the credit and to whom the goods are sold be shown in the letter accurately, as it is on the strength of this information that invoices, insurances, bills-of-lading and drafts, if necessary, are drawn.

Fourth—Amount of Credit: The



The Sales Department, American Steel Export Company, New York, N. Y.

amount of credit is, of course, one point usually clearly stated.

Fifth—Material to be Furnished: The kind of material and quantity are usually stated clearly, but frequently mention is made in credits for steel on the basis of tons, without specifying whether the tons are “gross tons”—of 2,240 pounds, or “net tons”—of 2,000 pounds. This is an important point and one that should receive careful attention. The price per unit, such as “\$5 per 100 pounds,” or “\$100.00 per gross ton,” etc., in the case of steel, or “\$30 per package” in the case of tin plate, etc., should be clearly stated for the protection both of the merchant and the

purchaser, as well as the banker—in assisting the proper checking of invoices when presented for payment. The delivery point is very essential as designating the point at which the seller turns over the possession of the merchandise to the buyer. It may be:

“F. O. B. Cars (Domestic Port) Within Free Lighterage Limits”: In this case the seller agrees to bring the goods to New York, but assumes no liability for the arrangement of steamer space to put the goods on board, nor does he assume any liability for storage if the material should lie at seaboard awaiting steamer space; but it does carry with it the agreement to bring the



Partial View of the Accounting Department, American Steel Export Company, New York, N. Y.



View of the Purchasing Department, American Steel Export Company, New York, N. Y.

material to New York on such railroad rates as will entitle the material to the privilege of free lighterage alongside steamer when the space has been secured. On these terms payment is due on presentation of railroad bills of lading with invoices.

"F. A. S. (Domestic Port)": In this case the seller agrees to put the goods alongside steamer, but is not required to take out ocean bills of lading or insurance. On these terms, payment is due on presentation of railroad bill of lading or steamer receipt, as may be agreed.

"C. I. F. (Port of Destination)": In this case the seller agrees to bring the material to port of embarkation, place it on the steamer, take out ocean bills of lading, consigned "to order" blank endorsed (unless otherwise stipulated) and secure marine insurance on the particular shipment. (War risk insurance is usually excepted by the seller as being an indeterminable charge at time of sale. When it is so excepted, the cost of war risk is added to C. I. F. price in submitting invoices for payment. Occasionally, buyers arrange to take out their own war risk insurance on cabled advice of clearance from our ports, but such arrangements are often unsatisfactory to all parties concerned.) Seller must also take out the necessary consular papers to clear the merchandise for the country to which consigned,

and present all these documents to the bank for payment.

"C. & F. (Port of Destination)": In this case the seller agrees to bring the material to port of embarkation, secure steamer space to destination, place the material aboard the steamer; get ocean bills of lading and take out the necessary consular papers, but is not required to take out either marine or war insurance except when specifically advised, in which case the insurance is billed as a separate cost.

These delivery terms are undoubtedly thoroughly understood by the majority of banking and commercial houses. However, this article will be considered quite worth while if it clarifies to any extent any of the terms of delivery before mentioned.

Sixth—*Documents Required*: This point of documents again is a very important one and frequently is not clearly or thoroughly stated. It is understood that the terms of delivery before mentioned will govern to a large extent the documents required, but very frequently letters of credit are issued calling for documents that do not correspond with the terms of delivery. For instance, merchants selling material "F. O. B. cars New York," payable against railroad bills of lading, could hardly accept a letter of credit specifying "Payment Against Railroad Bills of Lading, Marine and War Insurance

Policies," and yet such letters of credit are often issued by many of the banks.

Seventh—Expiration Date: It is generally conceded that an irrevocable credit must bear a time limit, thus an "expiration date" is usually shown. Whether or not a bank could legally be held to a credit advised as "irrevocable" without giving a date of expiration at which time the said credit would automatically be cancelled, we will not attempt to discuss, but will assume that it would be safer for all concerned if this particular were always clearly designated. Many credits are received by our domestic banks by cable and their details are sometimes not clearly enough shown to establish at once the date of expiration. In some cases such credits are advised to the merchants as "expiration date to follow by mail," "expiration date later," or "in the absence of instructions we are placing on this credit a time limit of six months,

subject to revision when definite advices are received." In the present market, these terms are not as a rule acceptable to the export merchant and considerable delays and cable expense could be avoided if the banks could, by communicating with their correspondents abroad, have the opening cables more explicitly worded.

In conclusion, may I again state that the efficiency of letter of credit transactions would be greatly increased if some concerted action were taken by the banks, first, to adopt among themselves some standard forms of reporting these letter of credit transactions, and second, to educate their foreign correspondents in the requirements of this market and the essential points of these letter of credit transactions, especially on those points which now seem to be susceptible of misinterpretation, or which are not clearly understood.



Supplies in Storage

TWENTY-FIVE PER CENT. of the coal mined each year in the United States is wasted (Bureau of Mines). There are this year in cold storage in this country thousands of pounds more than last year of beef, smoked beef, pork, lamb and poultry—in some instances 50 per cent. more. Prices on nearly all these things, however, have advanced very materially, notwithstanding the extra supply, due to the price of grain used in the manufacture by natural process of these various meats.

Because the harvest, on the whole, this year promises to be abundant and because stored supplies, especially of meats as above quoted, are larger than last year, an impression may be produced that there is no use of conservation of foods. As it is, the urgency of passing the Food bill is not yet generally recognized. But that a practical, efficient working control of food is one of the most important moves for war success, must be impressed upon the people widely.—*The Bache Review.*

Banking and Financial Notes

NEW PRESIDENT OF CHEMICAL

At a meeting of the board of directors of the Chemical National Bank, held on July 16, 1917, Herbert K. Twitchell, formerly vice-president of the bank, was unanimously elected president in the place of the late Joseph B. Martindale. Mr. Twitchell was born in Weybridge, Vermont, November 26, 1865, and received his education in the local schools and at Seeman Academy, New Haven, Vermont. In 1884 he entered the employ of the Travelers Insurance Company of Hartford, Conn., and spent about six years with that company and with the Charter Oak National Bank and the Hartford National Bank of that city, coming to New York in 1889 to accept a position as assistant paying teller of the Chase National Bank. In 1900 he was appointed assistant cashier of that bank, remaining in that position until he came to the Chemical National Bank as assistant cashier in 1907. He was elected vice-president in 1911 and a member of the board of directors the following year.

Mr. Twitchell is a director of the Bankers Trust Company, president and director of the Southern Round Bale Press Company, and a director of the Trion Manufacturing Company of Trion, Georgia. He is a trustee of Middlebury College, Middlebury, Vermont, and of Adelphi College, Brooklyn, and is a member of the Bankers Club and of the University Club of Brooklyn.

MECHANICS AND METALS ISSUES HISTORICAL BOOKLET

The career of the Mechanics and Metals National Bank of New York city, which had its beginning more than a century ago in a remodeled dwelling house on Wall street, and is to-day one of the largest of the banking institu-

tions in the United States, with total resources of more than \$200,000,000, is told in an interesting booklet which has just been issued by that bank. The General Society of Mechanics and Tradesmen, at the time one of the most powerful societies for political and moral influence in the state, was responsible for the formation of the bank. The motive of the society was to benefit mechanical interests and be "conducive to the successful conducting of the manufactures" in the city.

Chartered March 23, 1810, and known originally as the Mechanics' Bank, this institution took a place in a different world than that which we



The Branch
Our first President

Merchants National Bank

RICHMOND, VA.

Capital \$400,000
Surplus and Profits over 1,000,000

The Gateway to and Collection
Center for Southeastern States

Send Us Your Items

"ON TO RICHMOND"

Kings County Trust Company

City of New York, Borough of Brooklyn

Capital \$500,000 Surplus \$2,000,000 Undivided Profits \$800,000

OFFICERS

JULIAN P. FAIRCHILD,
WILLIAM HARKNESS,
D. W. McWILLIAMS,
WILLIAM J. WASON, JR.,

JULIAN D. FAIRCHILD, *President*

Vice-Presidents

THOMAS BLAKE, *Secretary*
HOWARD D. JOOST, *Assistant Secretary*
J. NOBMAN CARPENTER, *Trust Officer*
GEORGE V. BROWER, *Counsel*

ACCOUNTS INVITED.

INTEREST ALLOWED ON DEPOSITS.

know. As the booklet telling the story points out, "capital was scanty, banking was provincial and local, and the United States was in its infancy, struggling for a place in the family of na-

There was not a railway on the face of the earth. Steamship communication was unknown; the foreign mail was delivered sometimes seven weeks after being dispatched from London. No electric cable or telegraph linked the people together.

In the lifetime of this bank the booklet tells how there has been brought to the world an amazing development of human progress. Wealth has vastly increased. Capacity for production has grown with notable strides. Commercial intercourse has been so revolutionized that there has come about an entirely new interchange between this and other nations of men. As transformation has come in other lines it has come in the line of credit. In the course of a century men have abandoned their primitive instincts to think and act in big units. The transition from individual activity to the tremendous power of organization has shown its results more and more in finance. Thus, in a century there has come the evolution of the American banking system to the state of its highest efficiency, as epitomized in the Mechanics and Metals National Bank to-day.

From the earliest days of its career this bank did a healthy business and was prosperous. For a long time it was noted for receiving larger deposits and paying more checks than any bank in New York City. In 1834 loans and discounts of the Mechanics' Bank were \$4,199,218, an amount greater than any other bank reported. In that year the bank was selected by the Treasury De-

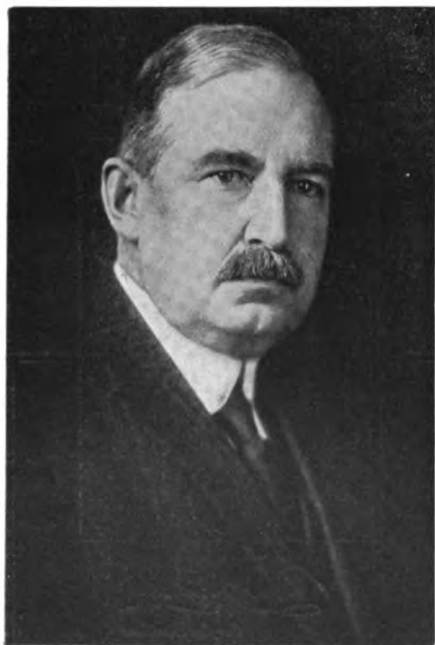

GATES W. MCGARRAH

President, Mechanics & Metals National Bank,
New York

tions." No one at that time knew, or could conceive, the progress that was to come. The American continent was unspanned, even by the emigrant wagon; there was no conception of the great west that lay beyond the Ohio River.



The Chemical National Bank of New York

(Established 1824)

Only Seven Presidents in Ninety-Three Years

THE announcement of the election of Herbert K. Twitchell as the successor of Joseph B. Martindale as President of The Chemical National Bank calls attention to the fact that in ninety-three years the bank has had only seven presidents.

It will be the policy of the present administration to continue the observance of those sound banking principles which, together with courteous treatment of its customers, have always formed a part of this institution's policies.

H. K. Twitchell, President

Francis Halpin, Cashier

James L. Parsons, Assistant Cashier

E. H. Smith, Assistant Cashier

I. B. Hopper, Assistant Cashier

J. G. Schmelzel, Assistant Cashier

DIRECTORS

Frederic W. Stevens

Robert Walton Goelet

Arthur Iselin

Ridley Watts

W. Emlen Roosevelt

Charles Cheney

Frederic A. Juilliard

H. K. Twitchell

partment, on the removal of Government deposits from the United States Bank, as one of the three institutions to be a depository of the Government.

Its services through the panics of 1837, 1857, 1873, 1893, 1907 and 1914 testify to the manner in which this bank has upheld the best traditions of the field in which it operates; the position attained in the financial community testifies to the reward that has come to it through adherence to high principle. It was this institution which took a leading part in the establishing of the New York Clearing House, five banks in 1852 forming an association and settling their daily balances with one another in certificates issued by the Mechanics' Bank. In the following year, in response to a call from the Mechanics' Bank, a meeting of bank officers was held to consider the matter of systematized check clearings, and on October 11, 1853, the New York Clearing House handled its first exchanges.

A copy of the booklet telling the

story of this bank's growth will be sent to anyone requesting it.

R. E. JONES, WITH MERCHANTS NATIONAL BANK OF NEW YORK

Raymond E. Jones, heretofore with the New York Agency, the Royal Bank of Canada, has been elected a director and vice-president of the Merchants National Bank and entered upon his new duties August 1. He will hereafter devote his entire time to the Merchants Bank. Mr. Jones has spent his banking career of seventeen years with the New York Agency of the Royal Bank, and during the time in which he has been at the head of the agency the American business of the bank has increased very rapidly. Mr. Jones is a native of New York and is well known to American bankers. He has kept in close touch with American banking methods, particularly in their relations to foreign business. On account of his experience and through its relations with the Royal

DJÖRUP, EDWARDS & McARDLE

Bank, Commercial, and Foreign
Exchange Audits and Systems

42 BROADWAY

NEW YORK

Bank, the Merchants will be well equipped for the transaction of any business of this nature, the entire facilities of the Royal Bank being placed at the disposal of the customers of the Merchants.

Other directors have been elected as follows:

J. E. Aldred of Aldred & Co., chairman of the Board of the Consolidated Gas, Electric Light and Power Company of Baltimore and of the Pennsylvania Water and Power Company; president of the Shawinigan Water and Power Company of Canada.

Nicholas F. Brady, president of the New York Edison Company; chairman of the Board of the Brooklyn Rapid Transit Company.

Arthur V. Davis, president of the Aluminum Company of America and director of the Mellon National Bank and the Union Trust Company of Pittsburgh, Pa.

These additions to the board are the result of the purchase by the above mentioned and others of the stock of the bank, formerly held by a syndicate. The control of this institution now rests in the hands of a strong, independent financial group, whose influence and support precludes domination

by any special interests and assures a continuation in the future of the conservative methods and the careful, painstaking service which has charac-



RAYMOND E. JONES
Vice-President Merchants National Bank, New York

WANTED—A BANKER

One who has had experience and is willing for the present to identify himself in a minor capacity with a rapidly growing institution located in a city in the neighborhood of Albany. References with a statement as to previous banking connections desired. ADDRESS: "PRACTICAL" care THE BANKERS MAGAZINE, 253 Broadway, New York.

terized the management of this bank for more than one hundred years.

The Board of Directors now consists of the following: J. E. Aldred, Aldred & Co., New York; Nicholas F. Brady, president New York Edison Co.; Theodore E. Burton, president; Arthur V. Davis, president Aluminum Co. of

“The Bank That Service Built”

THE

SEABOARD NATIONAL BANK

OF THE CITY OF NEW YORK

Capital	\$1,000,000
Surplus and Profits (Earned)	3,168,263
Deposits	57,000,000

<p>C. C. THOMPSON, Vice-President</p> <p>B. L. GILL, Vice-President</p> <p>W. K. CLEVERLEY, Vice-President</p> <p>L. N. DeVAUSNEY, Vice-President</p> <p>H. W. DONOVAN, Cashier</p>	<p style="text-align: center;">S. G. BAYNE, President</p> <p>O. M. JEFFERDS, Asst. Cashier</p> <p>C. C. FISHER, Asst. Cashier</p> <p>J. D. SMITH, Asst. Cashier</p> <p>B. I. DADSON, Asst. Cashier</p> <p>J. E. ORR, Asst. Cashier</p>
--	--

DIRECTORS

SAMUEL G. BAYNE	HENRY C. FOLGER	STUART G. NELSON
WILLIAM K. CLEVERLEY	BENNETT L. GILL	JOSEPH SEEP
EDWARD J. CORNISH	EDW. H. R. GREEN	CHARLES C. THOMPSON
MICHAEL J. DEGNON	PETER McDONNELL	WILLIAM H. WOODIN

The success of this bank is founded upon a policy of painstaking, efficient and courteous service to all

ACCOUNTS INVITED

America; Eberhard Faber, vice-president Eberhard Faber Pencil Co.; Raymond E. Jones, vice-president; Arthur G. Meyer, Dry Goods Commission, New York; William F. Neu, treasurer Steel Rail Supply Co., New York; Charles E. Potts, president J. B. Locke & Potts, commission merchants; Carl F. Sturhahn, U. S. general attorney, Fire Reassurance Co. of Paris; William F. Wall, president Wall Rope Works, New York; George Zabriskie, Zabriskie, Murray, Sage & Kerr, New York.

The Advisory Council consists of the following: Frank G. Crowell, Hall, Baker Grain Co., Kansas City, Mo.; Joseph W. Harriman, president Harriman National Bank, New York; Anthony R. Kuser, vice-president Public Service Corporation of New Jersey, Newark, N. J.; Waldo Newcomer, president National Exchange Bank, Baltimore, Md.; Dean Sage, New York; George C. Van Tuyl, Jr., chairman, president Metropolitan Trust Co., New York.

A RECORD CHECK

The largest check which has ever passed through the New York Clearing House so far as the records show was paid by the Liberty National Bank on August 10, amounting to \$96,111,111.11, drawn by Messrs. J. P. Morgan & Company, to the order of the Agents of the Bank of Montreal for the credit of the Minister of Finance and Receiver-General of Canada. The largest check which the records show as having been previously paid amounted to approximately \$70,000,000.

LAST STATEMENT OF GUARANTY TRUST

As of June 20, 1917, the Guaranty Trust Company of New York shows total resources of \$601,526,096.93 against \$520,744,575.24 on June 30, 1916. Deposits are \$498,161,281.92, which compares favorably with \$437,992,912.82 on June 30, 1916. The surplus fund is \$20,000,000 on both statements while the undivided profits are \$5,180,165.58 on June 30, 1916, and



100 YEARS OF COMMERCIAL BANKING

LOUIS G. KAUFMAN
President

FRANK J. HEANEY
Vice-President
WILLIAM H. STRAWN
Vice-President
NORBORNE P. GATLING
Vice-President
H. A. CLINKUNBROOMER
Vice-President
ROLFE E. BOLLING
Vice-President
HENRY L. CADMUS
Asst. Cashier
HENRY C. HOOLEY
Asst. Cashier

RICHARD H. HIGGINS
Vice-President
BERT L. HASKINS
Vice-Pres. and Cashier
C. STANLEY MITCHELL
Vice-President
MAX MARKELL
Vice-President
GEORGE R. BAKER
Vice-President
WALTER B. BOICE
Asst. Cashier
VINTON M. NORRIS
Asst. Cashier

JOSEPH BROWN
Asst. Cashier
GEORGE M. HARD
Chairman

ACCOUNTS INVITED

Resources Ninety-six Million Dollars

\$5,997,379.26 on June 20, 1917. The bank has a capital stock of \$20,000,000.

CHASE SECURITY CORPORATION FURTHERED BY SPECIAL DIVIDEND PAYMENT

The Chase National of New York has paid a dividend of twenty-five per cent. to stockholders, which dividend, as evidenced by a letter sent to stockholders is to be used for the organization of a new securities company. The letter reads as follows:

"The special dividend of twenty-five per cent. contemplated by the agreement between the stockholders of this bank providing for the organization of Chase Securities Corporation has been paid and, in accordance with the provisions of such agreement, your proportion of the dividend was paid directly to the committee of stockholders. This dividend was expressly declared and was paid out of surplus earnings or profits of the bank which accrued prior to March 1, 1913, and appropriate entries to that effect have been made on the books of the bank, for which reason, we understand, that the dividend is not taxable under the Federal Income Tax Law, and need not be included in your next return.

"We are sending you this notice be-

cause of a ruling of the Commissioner of Internal Revenue to the effect that a stockholder of a corporation, which now declares and pays a dividend from surplus earned prior to March 1, 1913, may only omit the amount thereof from his income tax return, if he receives from the corporation paying the dividend a statement that the same "was declared and paid out of surplus and undivided profits accumulated prior to March 1, 1913, and that the books of the corporation reflect such an amount."

DEPOSIT GROWTH OF THE LIBERTY NATIONAL BANK

The steady growth in deposits of the Liberty National Bank is shown in the following figures taken from recent statements of the bank:

Deposits, 1913-1917:

August,	1913.....	\$27,287,529.50
June,	1914.....	33,587,128.51
May,	1915.....	37,693,605.39
September,	1915.....	47,628,844.80
May,	1916.....	62,487,744.96
March,	1917.....	76,603,431.60
May,	1917.....	76,982,352.44

HARRIMAN NATIONAL DIVIDEND

On July 10 the Harriman National Bank of New York declared a semi-annual dividend of five per cent., payable

Service

The Citizens National Bank of New York for sixty-six years has specialized in accounts of merchants, and is located in the heart of the district where the largest part of New York's mercantile business is transacted.

We are thoroughly equipped to render the best of service to correspondent banks covering their requirements of every nature in New York.

THE CITIZENS NATIONAL BANK OF NEW YORK

Capital, Surplus and Undivided Profits \$5,000,000

EDWIN S. SCHENCK, President

FRANCIS M. BACON, JR., Vice-Pres.

GARRARD COMLY, Vice-Pres.

ALBION K. CHAPMAN, Cashier

JAMES MCALLISTER, Asst. Cashier

JESSE M. SMITH, Asst. Cashier

WILLIAM M. HAINES, Asst. Cashier

to stockholders of record at the close of business July 5, 1917, after having last January declared its first dividend of 100 per cent. The bank has deferred declaring the dividend from the earnings as usual in June until the half-year was actually closed. This bank with a capital and surplus of \$1,500,000 and deposits of about \$30,000,000 and undivided profits of \$490,000 shows earnings equivalent to the rate of thirty-five per cent. per annum.

BANK COMMENTS ON NEXT BOND OFFERING

Regarding elements necessary for the success of the next government liberty bond issue, the Mechanics and Metals National Bank of New York in its July 20 business and financial letter says:

"Much of the success of the next bond offering will depend on the manner in which the liberty loan has been absorbed by the country's investors.

Subscriptions to that loan represented for the most part operations in credit; thousands of men and women borrowed from their banks for the benefit of the nation, pledging their savings for months ahead in order that the war might be financed out of new capital rather than old. So, then, apart from the rate of interest that the next war loan of the United States will carry, an important matter contributing to the success of the loan will be the degree of absorption, on the part of the investing public, of the liberty loan.

"It is most desirable that, in the matter of government bonds already issued, the greater part be paid for and locked away before the next great fiscal operation of the government takes place; in other words, that both the public and the banks be free to contribute their unrestrained energies to the second loan. In every sense it is satisfactory to note that in the case of the liberty loan so important a volume of the new securities went into the

National Bank of Commerce in New York

PRESIDENT
JAMES S. ALEXANDER

VICE-PRESIDENTS
R. G. HUTCHINS, JR.
HERBERT P. HOWELL
J. HOWARD ARDREY
STEVENSON E. WARD
JOHN E. ROVENSKY
GUY EMERSON

CASHIER
FARIS R. RUSSELL



ASSISTANT CASHIERS

A. J. OXENHAM
WILLIAM M. ST. JOHN
LOUIS A. KEIDEL
A. F. MAXWELL
JOHN J. KEENAN
GASTON L. GHEGAN
A. F. BRODERICK
EVERETT E. RISLEY
H. P. BARRAND
R. W. SAUNDERS
H. W. SCHRADER
R. E. STACK

MANAGER FOREIGN DEPARTMENT
FRANZ MEYER

CAPITAL, SURPLUS AND UNDIVIDED PROFITS OVER \$45,000,000

hands of the ultimate investor. As the bonds are paid for, the banks and the money market will be relieved of a burden, and, also the danger will be lessened of the bonds surviving, in the money market, far beyond the period of the business created by their original issue. In matters of this kind, it is always desirable that first purchasers may be the last purchasers, so that the bonds may not be pledged indefinitely for loans, and that inflation may not come out of the spending of the same funds two or three times instead of once."

STATEMENT OF THE BANK OF NEW YORK

The last statement of condition of the Bank of New York as of June 20, 1917, shows total resources of \$66,898,019.11 of which \$35,655,811.11 is in loans and investments. The deposits are \$52,821,036.04 and surplus and undivided profits \$5,220,015.35. The bank has a capital of \$2,000,000, and was organized March 15, 1784, by Alexander Hamilton.

COMMENTS ON FREIGHT RATE DECISION

Knauth, Nachod and Kuhne, New York, in their excellent monthly publication on the investment situation have in the July number comment on the recent freight rate decision. The letter says:

"Much disappointment was expressed in investment circles because the Interstate Commerce Commission denied the fifteen per cent. freight rate increase asked for by the roads. The commission granted certain advances for eastern roads and altered class rates in such a way as to suggest that the relief provided might average eight per cent. for those roads.

"The roads may appeal to the commission next fall if conditions have changed in the meantime. The decision has aroused keen resentment in some railroad circles, where the findings have been criticised as short-sighted and not calculated to strengthen the roads with the investing public. The majority opinion states that the 'needs of certain weak lines cannot justify a course of action that is unwarranted by the condition of the large number of strong and successful lines.' Commissioner Harlan, who voted with the majority against his will, said he believed that the shippers would agree to a substantial increase in their rates provided it would result in an early betterment of the transportation service. Some of the railroad presidents contend that the failure of the commission to grant increased rates will have a serious effect upon the weak roads since the increase in the cost of labor and material has been twenty per cent., while the roads asked for only fifteen per cent. and did

not get that. On the other hand, the chairman of the National Shippers' Conference strongly endorsed the decision, saying that it would save the consumers and producers of the country \$750,000 a day. The decision as a whole is one of the most important ever rendered and it will be interesting to watch the developments in the railroad world during the next six months to see whether the commission was right in its judgment of a highly complicated situation."

APPOINT ALABAMA REPRESENTATIVE

The National Bank of Commerce in New York will be represented in Alabama by John T. Walker, Jr., who for the past two and a half years has been State Bank Examiner for Alabama. Mr. Walker was formerly with the Alabama Bank and Trust Company of Montgomery and is widely known throughout the Southern States.

AMERICAN FOREIGN BANKING CORPORATION

A new organization known as the American Foreign Banking Corporation with a capital of \$2,000,000 and organized by leading national banks throughout the country will begin business in New York about September 1. It is formed for the purpose of engaging in international banking and banking in the insular possessions of the United States. It is announced that Archibald Kains, who has just resigned as governor of the Federal Reserve Bank of San Francisco, will be president and Hayden B. Harris of New York and T. F. Aspden, now with the Canadian Bank of Commerce, will be vice-presidents.

The organizers include the Chase National Bank, of New York; Merchants' National Bank, Boston; First National Bank, Cleveland; Philadelphia National Bank, Philadelphia; Canal Bank and Trust Company, of New Orleans; National Bank of Commerce, St. Louis; Corn Exchange National Bank, of Chicago; First and Security



TRADE MARK

A bank which furnishes capital to promote a business should have absolute assurance that the business will be efficiently administered.

Such assurance is made possible through our Counselor Service. Write for particulars.

The G. K. Parsons Corp.

Engineers

Equitable Building New York

National Bank, of Minneapolis; Fifth-Third National Bank, of Cincinnati; Anglo and London-Paris National Bank of San Francisco, and First National Bank, of Milwaukee.

ELECTS NEW OFFICERS

At a meeting of the board of directors of the United States Mortgage and Trust Company of New York held June 29, 1917, John A. Hopper and George C. Hoffman were elected assistant treasurers.

HANDLES LARGE VOLUME OF SECURITIES

Few people not connected intimately with the work have any idea of the volume of securities handled in the daily routine in a financial institution. The Bankers Trust Company announces that during the six months ending June 30 there were deposited in and withdrawn from its vault securities and cash of the par value of \$49,635,376,000. As



At the Gateway to the Great Southwest

The National Bank

of Commerce

IN ST. LOUIS

offers its services for the prompt and dependable handling of your banking business in this section of the country

Capital, Surplus and Profits, over \$13,000,000.00

*“Large enough to serve any—
Strong enough to protect all”*

TOM RANDOLPH, Chairman of the Board

JOHN G. LONSDALE, President

W. L. McDONALD, Vice-President

W. B. COWEN, Vice-President

J. A. LEWIS, Vice-President and Cashier

safe deposit vaults are not rented to the public, this stupendous total represents only transactions connected with the company's business.

EDWARD DE LIMA PROMOTED

At a meeting of the executive committee of the Guaranty Trust Company of New York, July 12, Edward de Lima was appointed an assistant manager of the foreign department.

Mr. de Lima returned recently from an eight months' business trip to Spain, Portugal, Argentina, Uruguay, Chile, Peru and Panama. Prior to joining the Guaranty, last November, he was a member of the firm of D. A. de Lima and Sons, of New York city. He is a brother of E. A. de Lima, president of the Battery Park National Bank.

NEW APPOINTMENTS ANNOUNCED

The National Bank of Commerce of New York announces the following appointments which were effective July 1: R. E. Stack, R. W. Saunders, H. W. Schrader, assistant cashiers; A. F.

Johnson, auditor; G. S. Rodriguez and P. F. W. Ahrens, assistant managers foreign department.

JOINS NATIONAL BANK OF COMMERCE

The National Bank of Commerce in New York announces that H. G. Stenersen has joined its new business department. Mr. Stenersen has been connected with the Travelers' Insurance Company of Hartford, Conn., for the last nine years. He was cashier in the branch offices at Hartford, Conn.; Syracuse, N. Y., and San Francisco, Cal., before being transferred to New York five years ago. Recently he has been assistant manager in charge of agency organization work at the Metropolitan branch, 76 William street.

RETIRES CIRCULATING NOTES

It is disclosed by the last weekly statement of the New York Clearing House that the National Bank of Commerce reports no outstanding circulating notes.

On inquiry at the bank it was stated

that the retirement of the small amount of notes recently outstanding, amounting to only \$155,000, has no significance, but was solely to clear the books of a relatively unimportant item.

A recent amendment to the Federal Reserve Act repealed a former provision of law which required national banking associations to maintain a minimum deposit of United States registered bonds with the treasurer of the United States.

The Clearing House statement further shows that the Importers and Traders National Bank reports national bank circulation of \$51,000, the Seaboard National Bank \$70,000, the Hanover National Bank \$172,000, the Chase National Bank \$650,000 and the Chemical National Bank \$444,000.

WILLIAM AVERY PROMOTED

William George Avery was appointed, July 2, an assistant manager of the foreign department of the Guaranty Trust Company of New York. He has been associated with that company since April 1, 1916.



WM. GEORGE AVERY
Assistant Manager Foreign Department, Guaranty Trust Company of New York

Our officers give personal attention to customers

One of the distinguishing features of The FIDELITY'S superior service is the personal attention given by our officers to the individual banking and trust problems of customers. The officers are all easily approached, always glad to see you. You do not have to wait but to hand, outside closed doors, in order to see them. There is only a low railing, with several open gates, between them and the public.

You are invited to come in and talk over with our officers any matters connected with your business or your trusts in which The FIDELITY can possibly be of service.

FIDELITY TRUST COMPANY
Charles and Lexington Streets



An advertisement
prepared by
EDWIN BIRD WILSON, Inc.
Financial Advertising
Bankers Trust Building
NEW YORK

Mr. Avery was born in England in 1879 and was educated in English schools. His business experience prior to 1916 included ten years with the Capital and Counties Bank, Ltd., London, England, and ten years with Canadian banks.

ALTERATION TO TRUST COMPANY BRANCH

The work of remodeling the Seventy-fifth street branch of the United States Mortgage and Trust Company, New York, formerly the Fidelity Bank, recently absorbed by the trust company, has just been completed by Hoggson Brothers.

The entire first floor quarters have been enlarged and rearranged to provide increased officers' space and a retiring room for women patrons. The decorations throughout are in white and



A Service Suited to Your Needs

Now is the time when your New York business requires close personal attention. Our facilities permit this kind of service.

ATLANTIC NATIONAL BANK

257 BROADWAY, NEW YORK

CAPITAL, SURPLUS AND UNDIVIDED PROFITS \$1,800,000

RESOURCES OVER \$20,000,000

gray, giving a very pleasing effect. The basement has been remodeled to provide increased facilities for the United States Safe Deposit Company.

The United States Mortgage and Trust Company has just let contract to Hoggson Brothers for making alterations and improvements to its branch quarters at Broadway and Seventy-third street.

LIBERTY BANK'S NEW ISSUE

The capital stock of the Liberty National Bank has been increased from \$1,000,000 to \$3,000,000, the details of the transaction having been approved by the Controller of the Currency. Interim certificates have been issued to stockholders.

According to the arrangement voted by the directors, the old stockholders received the privilege of subscribing to two shares of the new stock at par for every share of old stock that they held. The surplus of the bank has been increased from \$2,000,000 to \$3,000,000.

CITIZENS NATIONAL TO REMODEL QUARTERS

The banking quarters of the Citizens National Bank of New York, until recently the Citizens Central Bank, are being extensively remodeled. Because of its rapidly increasing business, the bank has found it necessary to take over for its own use considerable space formerly occupied by other tenants. Hoggson Brothers are to conduct the work of alteration without interruption to the bank's business.

The alteration on the main floor will include the adjustment of the present counters and cages to enable the several departments to occupy the spaces vacated by the auditing and credit departments, which will be installed in the basement. The officers' space will be enlarged and a public reception room provided with openings into the directors' room as well as into the private offices of the president and vice-president.

The basement quarters will be en-

larged and equipped to provide for the auditing and credit and foreign exchange departments, with special retiring rooms for officers and employees.

A large dining-room, a retiring room for women employees equipped with metal lockers and ivory finish furniture and an additional room for the men employees will be provided. A timely improvement will be a pistol range affording target practice for the employees.

The space for the foreign exchange department will be increased four times its present size, this being one branch of the company's rapid expansion. The public space will be separated from the credit department by a low oak counter rail with double swinging gates. To insure excellent ventilation, fan exhausts and ventilating ducts are being installed.

THE FIRST NATIONAL ON RECENT EVENTS

In its July 16, 1917, business and financial letter, the First National Bank of Philadelphia comments favorably upon recent events and says:

"No six weeks' period in the financial history of this country has witnessed more striking developments than have been reported since the opening of June. These have included the heavy over-subscriptions for the largest initial war loan that any nation ever brought out, the raising of \$115,000,000 for the Red Cross war fund, the financing of the record \$325,000,000 July interest and dividend payments, the shifting of the balances called for by the recent amendments to the Federal Reserve Act, the advance in the price of cotton to the highest level touched in half a

The Banker's Allies

From a hundred-thousand sources comes the urge to save. Thrift is a national topic; America at last awakes.

With the Banker stand the Government, the press, the school, public and private organizations everywhere, staunchly allied.

Rightly the Banker leads; focuses upon his Institution an unprecedented public interest, and for comprehensive plans he consults

Collins Publicity Service
Philadelphia, Penna.

century, the further rise in the price of steel, coke and pig iron to unprecedented figures and the top-speed production in many industries, with the unusual legislative proposals in the effort to control the production, distribution and exportation of foodstuffs and raw material."

PRESIDENT CORN EXCHANGE COMMENTS ON JAPAN

"The Advance," which is the monthly publication of the Corn Exchange Bank of Philadelphia, dealing with the business and financial interests, in its June 27 number contains a significant statement by the bank's president, Charles S. Calwell, on Japan. This statement is as follows:

"Fear has been the dominating influence in our relations with Japan. While we have not acknowledged it,

BANKS ORGANIZED, FINANCED, BOUGHT AND SOLD, everywhere; ample funds always on hand for good new, or old dividend paying bank stocks, carrying official positions. Highest class, confidential selling and buying service rendered banks, bankers and investors. JOHN P. JONES, Monadnock Block, Chicago, Ill.

BUFFALO—now leading in the manufacture of aeroplanes.

For information pertaining to this city and its industries—write us.

Citizens Commercial Trust Company

Capital and Surplus, \$2,500,000

the whole country has feared Japan's military strength even more than her commercial efficiency. Now, when our own military position strengthens to a point where fear disappears let us look Japan in the eye and say 'Let us be friends.'

FUEL SITUATION IN PITTSBURGH

In its July business and financial letter the People's National Bank of Pittsburgh reports that commercial conditions in that district remain much the same as a month ago. Several things of note have, however, happened there during the past month. The bank says:

"The price movement for the chief products of the district was almost continuously upward, the largest advances being in raw and semi-finished materials. Pig iron and steel billets have reached the highest level ever quoted.

"The most serious concern, however, is over the fuel situation. The output of coal is larger than at any previous time this year, but it is barely equal to current consumption and does not permit of stocking up at the season when such operations are usually conducted. At one time during the month a number of iron furnaces were temporarily banked because of lack of supply of coke, which was due to shortage of labor and railroad cars. As a consequence, famine prices continue to prevail for both coal and coke. Government business continues to receive preference in the matter of supplies and delivery, and is running beyond estimates

made two or three months ago. One effect is to hamper delivery on contracts for private and quasi-public consumers, and to keep in abeyance long-projected plans for improvements and extensions.

"A local incident of the month was the warning given by some of the natural gas companies that domestic consumers provide themselves with enough coal to supply at least one coal-burning stove for an emergency next winter when a shortage of gas may occur. Such possible shortage, it was explained, would be due to inability of the companies to obtain pipeage and drilling machinery with which to carry on field work this summer to meet increased gas consumption. High prices of other kinds of fuel have tended to increase consumption of natural gas for domestic purposes, and scarcity of labor and supplies has handicapped the work of drilling new wells. Similar conditions have affected the oil situation."

TRUST DEPARTMENT OF OLD COLONY BANK

The July number of the Old Colony News Letter, which is a monthly publication designed to give information and helpful suggestions to all members of the organization of the Old Colony Trust Company of Boston, contains an article showing the duties and growth of the trust department. As reported by the Letter:

"The trust department, from its inception, has acted as agent for individuals and corporations in the care and

management of their property. Its duties include the custody of stocks and bonds, collection of dividends, registered and coupon interest accruing therefrom, the remittance of the proceeds, the purchase and sale of securities, and in general, everything that the principal desires and instructs the department to do.

"Statistics are not accessible for the period prior to March, 1912, but the following figures will show the amount of the agency property held by the trust company since then:

YEAR	AMOUNT OF PROPERTY
1912.....	\$82,360,147.94
1913.....	128,768,395.78
1914.....	121,475,284.13
1915.....	129,238,815.81
1916.....	138,747,708.86
June 25, 1917.....	157,027,477.46

"In this connection it may be interesting to note that the number of the active agency accounts increased 100 per cent since July, 1911, and now amount to over 600."

BOSTON SAFE AND DEPOSIT TRUST COMPANY INCREASES DIVIDEND

The Boston Safe and Deposit Company of Boston at a recent meeting of the directors declared an extra ten dollars on each share of stock in addition to the regular semi-annual dividend of eight per cent.

NEW DIRECTOR FOR FIRST NATIONAL BANK OF BOSTON

Sidney W. Winslow, Jr., was elected a director of the First National Bank of Boston, Mass., at a recent meeting of the board. Mr. Winslow succeeds his father, the late Sidney W. Winslow.

NEW BANK FOR BROOKLINE

Brookline, Massachusetts, is to have a new bank which will be known as the Coolidge Corner National Bank. The bank will have a capitalization of \$100,000. Those who are now active in its organization are G. P. Higgins,

Resources

\$15,000,000.00

If intelligent handling of items and low rates appeal to you send us your Buffalo business



Try our Service and you will be entirely satisfied

- A. D. BISSELL, President**
- C. R. HUNTLEY, Vice-Pres.**
- E. H. HUTCHINSON, Vice-Pres.**
- E. J. NEWELL, Vice-Pres.**
- HOWARD BISSELL, Cashier**
- C. G. FEIL, Asst. Cashier**
- A. J. ALLARD, Asst. Cashier**
- G. H. BANGERT, Asst. Cashier**

The National Shawmut Bank of Boston

President
WILLIAM A. GASTON

Vice-Presidents
HAROLD MURDOCK
ABRAM T. COLLIER
NORMAN I. ADAMS
ROBERT S. POTTER

Cashier
WILLIAM A. BURNHAM, JR.



Assistant Cashiers
HENRY F. SMITH
FRANK HOUGHTON
FRANK A. NEWELL
GEORGE H. S. SOULE
GEORGE E. FICKETT

Auditor
CLARENCE E. DUNAVEN

Credit Manager
JAMES E. RYDER

Capital \$10,000,000

Surplus \$5,000,000

Undiv. Profits \$3,600,000

I. P. Gammon, F. S. Douglass, N. L. Hobart and Melvin Dean.

NEW HOME FOR ROCKLAND TRUST COMPANY

Work has been started on a new bank building at Rockland, Massachusetts, for the Rockland Trust Company, a successful institution which has been in business since 1907. The accompanying cut shows the style of the

Richmond, Va., during the past year is shown in a statement just issued by Governor Seay of the local bank. The total rediscounts of the bank, including July 21, amounted to \$25,405,107, while for the corresponding period last year the amount was only \$3,607,990, an increase of \$21,797,117, or more than \$1,000,000 a day.

In the last report issued by Governor Seay, the total resources of the



Proposed Building for the Rockland Trust Co., Rockland, Mass. Thomas M. James, Architect

building, which will be for the individual use of the company and will be fitted up with every appointment of modern banking. Thomas M. James of Boston is the architect of the building.

CONDITIONS IN RICHMOND

The remarkable growth in the operations of the Federal Reserve Bank of

reserve bank is shown to be \$78,212,000 having increased from \$27,849,058 during the past year. The gold reserve against net liability is seventy-eight per cent.

Keeping pace with the growth of the operations of the Reserve bank is the general banking business of the city as reflected in the Richmond Clearing



EQUIPPED FOR SERVICE

Located in a modern building with every facility for the efficient handling of its business, this bank is in a position to offer you prompt and adequate service in your Philadelphia banking transactions.

**UNION
NATIONAL
BANK**

PHILADELPHIA
Resources over
\$13,000,000



House Association report of July 21. The clearings for the month to that date amounts to \$79,641,274, while for the corresponding period in 1916 the amount was \$45,906,058, showing an increase during the year of \$33,735,216.

For the week ending July 21 the clearings of the Richmond banks aggregated \$26,744,112, and for the corresponding week last year \$15,859,038, showing an increase of \$10,885,074.

A slight decrease is shown in the statement of the condition of the Richmond banks on June 20, as compared with the call of the Comptroller of May 1. The total deposits of the banks amounted to \$77,645,182, being \$2,404,665 less than the amount reported May 1. During this period loans and investments declined from \$85,739,520 to \$84,540,527. Surplus and profits increased from \$10,096,900 to \$10,253,781.

The semi-annual dividends declared by the banks of Richmond July 1 amounted to \$298,377.50. The dividends of the Federal Reserve Bank

of Richmond for the period from November 1, 1916, to June 30, 1917, amounted to \$150,000. Dividends of other institutions, including the street railway company and insurance companies brought the total up to more than \$500,000.

COMMENTS ON FEDERAL RESERVE ACT

Commenting on the new requirements of the amended Federal Reserve Act just provided by Congress, the National City Bank of Chicago in its July business and financial letter says:

"The country's bank position is exceptionally strong and with the aid of the rediscount facilities of the Federal Reserve Banks—to which recourse is being made to a greater extent than ever before—the semi-annual settlement will be adjusted with little, if any, difficulty. Taking \$1,000,000,000 as the probable sum of these unprecedented payments, one has only to recall the disordered June 30 money markets of other years to appreciate the changes that have taken place, since the intro-



FREE SAMPLE

sent to any Banker desiring one of our

GEM HOME SAFES

Absolutely New
Carries Large Advertising Space
COST is EXTREMELY LOW
Beautiful in Appearance—
being heavily nicked on copper

Holds from \$12.00 to \$15.00

For FREE SAMPLE and full particulars,
write to

STRONGHART COMPANY

1510-12-14-1516 S. WABASH AVK.
CHICAGO, ILL.

duction of our centralized banking system made possible the mobilization of the country's gold reserve. Were the banks forced to provide for these record July payments under the old system of unrelated reserves at a time when this nation was engaged in a terrific war, the resultant disturbance might have had farreaching consequences."

CROPS DEPENDED UPON TO EQUALIZE
GOLD DISTRIBUTION THROUGHOUT
THE UNITED STATES

Vice-president Arthur Reynolds of the Continental and Commercial National of Chicago, predicts that money will continue to flow from the west to the east until the sale of crops in the agricultural states. This will prevent a too great accumulation of deposits in one section of the country and a corre-

sponding decline in the other. He further states as follows:

"In the banking situation there is present every element of strength, and the farmer, manufacturer and merchant may safely make their plans for the last half of the year on the assumption that there are ample banking resources to meet every legitimate requirement."

SAYS FEDERAL RESERVE ACT AMENDMENTS MEAN INCREASED STRENGTH TO THE SYSTEM

James B. Forgan, chairman of the board of the First National of Chicago, Ill., comments favorably, as follows, on the recent amendments to the Federal Reserve Act:

"The Reserve system is decidedly stronger for the amendments just passed. Three phases are particularly favorable. By inducing participation of many, perhaps a majority of the

The $\frac{B}{L}$ Bank of Chicago



We make a specialty of the collection of bill of lading drafts. We guarantee prompt, accurate and intelligent handling. This is one feature of our varied service offered correspondent banks.

We solicit correspondence regarding par collection of Western items for Eastern banks, and of Eastern items for Western banks.

UNION TRUST COMPANY
Chicago

An old, conservative bank doing strictly a commercial business—Established 1869



DEVELOPING
MAN-POWER
IN
BANKING



Some men, like machines, are replacable at cost, or less. Others are indispensable as the power which propels the modern super-dreadnought.

Modern banking needs these *power* men, men who can solve intelligently the intricate banking problems of today, who can create and develop new business, and who are capable of forming sound banking judgments. And there is a way of developing executive bankers, for the complex problems of present-day banking.

The New La Salle Course in Banking and Finance

offers for the first time, practical and fundamental training in banking—not merely for clerical work, but for the real brain work of modern banking. It makes a concrete appeal to bank officers, directors, cashiers, and bank employees, who have a spirit for the better things in banking.

A Few of the Noted Authorities in Banking and Finance Who Have Made this Course Possible

Eimer H. Youngman, Editor, The Bankers Magazine, New York City
 H. Parker Willis, Ph.D., Secretary, Federal Reserve Board, Washington.
 George E. Roberts, National City Bank, New York City.
 Arthur B. Hall, A. B., Real Estate Expert, Chicago.
 Louis Guenther, Editor, Financial World, New York City.
 Frederick Vierling, Trust Officer, Mississippi Valley Trust Company, St. Louis.
 Edward M. Skinner, General Manager, Wilson Brothers, Chicago.
 William Bethke, M. A., Director, Department of Business Administration, La Salle Extension University.
 Samuel D. Hirschl, S. B., J. D., Member Illinois Bar, Chicago.
 Frederick Thulin, LL. B., Formerly of the Union Trust Company, Chicago.

O. Howard Wolfe, Cashier, Philadelphia National Bank, Philadelphia.
 Walter D. Moody, Managing Director, Chicago Plan Commission
 R. S. White, Collection Manager, American Steel and Wire Company.
 C. M. Cartwright, Managing Editor Western Underwriter, Chicago.
 Warren F. Hickernell, A. B., Former Editor Brookmire Economic Service.
 Irving R. Allen, Sales and Advertising Counselor, Chicago.

60-Page Book "Banking and Finance" FREE upon Request

This publication will be mailed free and post-paid to any bank officer or individual interested. It contains useful information on modern banking questions and shows clearly what this course can do for the individual or for a bank. You owe it to yourself and your business to know about this work. Write for your copy today.



Address

LaSALLE EXTENSION UNIVERSITY

"The World's Greatest Extension University"

Dept. 4312-D

Chicago, Illinois

The National Stock Yards National Bank

AND

The National Cattle Loan Company

ST. LOUIS NATIONAL STOCK YARDS, ILLS.

Are the largest cattle financing institution in the Eighth Federal Reserve District

WIRT WRIGHT
President

O. J. SULLIVAN
Vice-President

ROBERT D. GARVIN
Cashier

larger state banks, additional capital will be centered in Reserve banks. The change in reserve requirements and regulations of note issue enables mobilization of large amounts of gold in Reserve banks where it will protect the banking system. Making gold deposited as collateral for Federal Reserve notes count as reserve for banks, adds to the central store and makes it easy to stabilize reserves."

STATEMENT OF FIRST NATIONAL OF CHICAGO

At the close of business June 20, 1917, the First National Bank of Chicago, Ill., showed total resources of \$195,705,718.07 and deposits of \$165,247,589.52. The bank has a paid-in capital stock of \$10,000,000 and a surplus fund of like amount. Other un-

divided profits amount to \$3,037,843.16. The stock of the First Trust and Savings Bank is owned by the stockholders of the First National Bank of Chicago. At the commencement of business June 21, 1917, the First Trust and Savings Bank had total resources of \$94,333,394.71. Deposits were \$83,459,440.71, of which \$52,372,306.12 was in time deposits and the remainder in demand deposits. Combined both banks show total deposits of \$248,707,030.23.

LIBERTY LOAN PREDICTIONS OF A CHICAGO BANKER

E. D. Hulbert, president of the Merchants Loan and Trust Company of Chicago, makes some interesting predictions for future Government loans, and particularly commends New York

SEND YOUR BUSINESS

ON THE

Twin Cities AND THE Northwest

TO THE

CAPITAL AND SURPLUS
TEN MILLION DOLLARS

We are prepared to meet your most exacting requirements and cordially invite you to write to us



HYDRO-CRETE

TRADE MARK

A NEW CONCRETE FOR BANK VAULTS

PRACTICALLY

FIRE, WATER AND BURGLAR PROOF

VAULTS INSTALLED AND UNDER CONTRACT

Federal Reserve Bank	- - - -	New York City
Guaranty Trust Company	- - - -	"
Metropolitan Life Insurance Company	- - - -	"
Sixty Liberty Street Corporation	- - - -	"
Rhode Island Hospital Trust Company		Providence, R. I.

BY THE

HYDROLITHIC WATERPROOFING CO., Inc.

1328 Broadway

NEW YORK CITY

bankers for their earnest and efficient work in the recent flotation. His remarks are as follows:

"The general expectation is that the next big issue by the Government will be only one-half as large and will carry four per cent., with the tax exempt and convertible features, that announcement of it will be made about the middle of July and the offering follow six or seven weeks later. Besides affording impressive demonstration of the country's financial strength and banking ability, the Liberty Loan accomplished a great purpose in making us all realize the size and seriousness of our war work. Considering the short time for selling the bonds and the country's unfamiliarity with such financing, it all turned out very well—just right.

"I cannot speak too highly of the part New York took in this matter. I have never seen any work done more unselfishly than the New York bankers performed this duty. Of course, the bankers and bond men elsewhere did their part, with few exceptions, or they

stood ready to do whatever was required to the extent that they understood their respective duties, but New York set the pace with a magnificent patriotism, of the discerning and achieving sort.

"The next loan will be taken more eagerly and more generally. We have found our investment stride. The bond market otherwise is likely to remain dull while the Government financing is worked out. The effect is naturally depressing to mortgage issues, but I do not look for any further appreciable recession in values. It is natural to expect that the amount of the third Government issue, and its terms, will depend a good deal upon the reception of the second."

CHICAGO BANK REPORTS NEW ENTERPRISES

Regarding new enterprises the National Bank of the Republic in Chicago in its July review of business says:

We Are Now a Member of the Federal Reserve System

Through our membership in the Federal Reserve System and the St. Louis Clearing House Association, complete facilities are offered Banks and Trust Companies for handling their business in St. Louis and throughout the entire Mississippi Valley, upon most favorable terms.

Complete Financial, Trust, Bond, Real Estate, Safe Deposit, Savings and Farm Loan Departments.

Correspondence Invited

Mississippi Valley Trust Co.

Capital, Surplus and Profits over \$8,000,000

ST. LOUIS



"Corporate enterprise has shown a corresponding increase in activity, the months of April and May witnessing an especially heavy output of charters of concerns capitalized for one million dollars or over. Much of this intense activity can, of course, be traced to conditions created by the war, and particularly by the continued destruction of ships. During the first five months of the year the total capital authorized in the incorporation of concerns for the purpose of engaging in activities variously associated with shipping and shipbuilding amounted to above \$123,000,000, more than four times the showing for the same period last year, and over half the total new capital so engaged during the entire thirty-four months of the war."

\$1,000 SLOGAN WINNER NAMED IN NATIONAL BANK OF COMMERCE CONTEST

Harold Maxwell, vice-president and general manager of the Samuel Cupples

Woodenware Company, has been announced as the winner of the \$1,000 gold prize offered by the National Bank of Commerce of St. Louis, Mo., in its slogan contest.

The slogan which won for Maxwell reads: "Large Enough to Serve Any—Strong Enough to Protect All." The judges, Mayor Kiel, M. L. Wilkinson, J. O. Ballard and John G. Lonsdale, were unanimous in the selection of Maxwell as the winner. Maxwell, as winner, is paid \$100 a word for his slogan.

"The booklet distributed telling of the conditions of the contest was an educational one," President Lonsdale said in speaking of the success of the offer, which attracted such widespread attention.

"We gave out more than 40,000 of the booklets, and it may safely be assumed that fully twice this number of people read the instructions. The contest carried with it the golden thread of thrift, because one of the conditions named for contestants was that the con-

Established
1857



60 Years of Con-
servative Banking

The
**Mechanics-American
National Bank**
of St. Louis

Capital, \$2,000,000

Surplus, \$2,500,000

Resources, \$41,426,000

A STRONG BANK WITH THE EQUIPMENT, THE EXPERIENCE AND
THE STRENGTH TO GIVE THE BEST SERVICE

ACCOUNTS INVITED

WALKER HILL, President

FRANK O. HICKS . . . Vice-President
JACKSON JOHNSON . . . Vice-President
EPHRON CATLIN . . . Vice-President

JOSEPH S. CALFEE Cashier
CHARLES L. ALLEN . . . Asst. Cashier
JAMES R. LEAVELL . . . Asst. Cashier
WILLIAM H. HETTEL . . . Asst. Cashier

testant must be or intend becoming a depositor in some bank.

"Several thousand of the slogans offered were based on the assumption that, with our very large protection fund for depositors, we have or ought to have a savings department. The public demand thus manifested is causing our management to give the matter serious consideration and we are working out a readjustment of our floor space to provide room for one or more new departments, including one for savings."

ADVERTISING EXHIBIT TO BE DISPLAYED
AT THE ATLANTIC CITY CONVENTION

M. E. Holderness, assistant cashier and trust officer of the Third National Bank of St. Louis, Mo., and chairman of the Financial Advertisers' Association, has announced that the exhibit of advertising which was displayed during the Advertising Men's convention is to be carefully stored in St. Louis, remounted, and shipped to Atlantic City



JOHN G. LONSDALE
President National Bank of Commerce in St. Louis

Is It Not Sound Policy

to send your Baltimore business to the bank whose half century of experience gives assurance of efficiency and strength?

For the handling of collections and all other banking business, this institution is admirably equipped.

Large capital, surplus and resources enable this bank to offer you complete banking facilities and services which are real and not visionary.

The National Exchange Bank Baltimore, Md.

Capital & Surplus, \$2,480,000 Resources, \$12,048,000

WALDO NEWCOMER, President

SUMMERFIELD BALDWIN, Vice-Pres.
CLINTON G. MORGAN, Asst. Cash.

R. VINTON LANSDALE, Cashier
JOSEPH W. LEFFLER, Asst. Cash.

for the A. B. A. convention this fall.

Delegates to the advertising convention pronounced the display the best of its kind ever collected, and the most complete. A panel five feet wide and 105 yards long was posted with newspaper advertising, booklets, and lithographed specialties, in seven different languages.

WALTER HULL GOES WITH BANKERS TRUST

Walter Henry Hull, formerly manager of the bond department of John Sinclair & Co., was recently appointed manager of the bond department of the Bankers Trust and Savings Bank of Minneapolis, Minn.

REPORTS NORTHWESTERN CONDITIONS

The Northwestern National Bank of Minneapolis in its July financial and business review states that a bankers' report of conditions in almost any section of this territory could often be mistaken for a crop report since good crops mean money in the bank. "On

the whole," the bank reports, "everything in the Northwest is very encouraging. Weather has been holding the crops in check. Corn is late, but small grains are flourishing. The acreage is large. Potatoes and vegetables are greatly increased. No farm labor shortage is reported, but it is the lull before the storm. It is the western part of our district that will suffer most, if the problem is not well handled from the supply centres. Some of our crops in North Dakota, Montana and South Dakota have been put in on faith. To shatter this confidence in coming of outside aid at harvest time will be disastrous."

STOCKTON BANK CLEARINGS

The bank clearings for Stockton, Cal., have just reached the \$40,000,000 mark for the first half of 1917, totaling \$40,289,108 for the six months. This is an increase of \$9,346,171, or 30.2 per cent. over the corresponding period last year. The clearings for June were



ESTABLISHED 1865

PEIRCE SCHOOL

OF BUSINESS ADMINISTRATION

Pine Street, West of Broad

PHILADELPHIA

A Business Course, including banking, accounting, business management, commercial law and other practical subjects, which forms an admirable substitute for a college education and saves from two to three years of time.

Special Courses in banking and business administration for students who have had one or more years in college.

Secretarial Courses for those desiring to prepare themselves for secretarial work.

The school is known throughout the United States for the excellence and thoroughness of its business training. Its graduating classes have been addressed by ex-Presidents Taft, Roosevelt, Harrison and Cleveland.

One of the best school buildings in the country; large gymnasium.

Students may enter at any time during the school year.

Fifty-second Catalogue and Illustrated Booklet will be mailed upon application.

\$6,731,809 as against \$6,939,387 for January. In 1916 they were \$4,836,816 in June.

KANSAS BANKERS ASSOCIATION CONVENTION

On Thursday and Friday, May 23 and 24, in Hutchinson, Kan., was held the thirty-first annual convention of the Kansas Bankers Association.

SAN JOAQUIN COUNTY BANKS

The fact that country banks in San Joaquin County, California, have increased nearly \$1,200,000 during the last year is evidenced by the report of the Stockton Chamber of Commerce as of June 20, 1917. This report is exclusive of Stockton Banks and shows that upon that date the total resources amounted to \$4,626,659.46 as against \$3,437,737.07 on June 30, 1916. Deposits on June 20, 1917, were \$28,172,832.53 as against \$22,208,674.27 on June 30, 1916.

STATEMENT OF CROCKER NATIONAL

The Crocker National Bank of San Francisco in its last statement as of June 20, 1917, showed total resources of \$41,199,366.36 and deposits of \$31,183,817.70. The capital stock is \$2,000,000 and surplus and undivided profits amounted to \$3,889,519.50.

Accurate News of Pacific Northwest

Have You Business or Investment Interests in Washington, Oregon, Montana, Idaho, Alaska or British Columbia?

The authoritative commercial and financial publication of this section is BUSINESS CHRONICLE OF THE PACIFIC NORTHWEST issued every Saturday Morning. It tells what you need to know of banking, investments, lumber, fish, apples, agricultural products, mining, foreign trade, railway and marine transportation, commercial and business affairs generally, and analyzes current progress and development. You may rely upon what you see in its columns.

Send for free sample copy. There is no paper like it anywhere.

BUSINESS CHRONICLE

EDWIN SELVIN, Editor
Alaska Building SEATTLE, U. S. A.

Ask Your Stationer for
Bankers Linen and Bankers Linen Bond

Made in Flat Papers, Typewriter Papers and Envelopes

They are fully appreciated by the discriminating banker desiring high-grade serviceable paper for correspondence and typewriter purposes

SOLE AGENTS

F. W. ANDERSON & CO.

INCORPORATED

34 Beekman Street, New York

COMMENTS ON CAR SHORTAGE

That the car shortage throughout the country is not becoming less serious is the fact brought out by the American National Bank of San Francisco in its June 25 financial letter. Attention during the past month has turned away from this problem but the bank again

reminds us that it is a matter of growing importance.

"Provided that the harvest turns out as well as experts predict," the letter says, "there is still a grave problem confronting the country in the growing car shortage that, contrary to custom, has steadily increased from month to month since January 1. On that date the net shortage reported by the American Railway Association was 62,247, and on May 1, the total had grown to 145,449. Ordinarily, during the summer months there is a considerable amount of idle equipment on nearly all lines, but this year our tremendous industrial activity has entirely reversed previous conditions. Considering that the country will, during the next few months, require facilities for the movement of many thousands of troops, with their accompanying equipment and supplies, the situation is anything but reassuring, and may require drastic government handling."

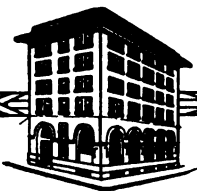

Berkeley, California

YOUR BERKELEY business is invited on the basis of prompt and efficient service. This bank is the oldest in the city and offers advantages worth the consideration of other bankers having business in this locality.

A. W. NAYLOR.....President
 F. L. NAYLOR.....Vice-President
 W. E. WOOLSEY..Vice-President
 W. F. MORRISH.....Cashier
 G. L. PAPE.....Asst. Cashier
 F. H. THATHER.....Asst. Cashier

**FIRST NATIONAL
 BANK of BERKELEY**



INCREASE IN SEATTLE BANK CLEARINGS

Figures now available of bank clearings for the first six months of 1917 in Seattle show an increase of \$211,126,218 over the corresponding period in 1916. June clearings were \$95,372,584, which is an increase of \$4,627,586 over May. Each month of this year has shown a successive increase over the preceding month.

SEATTLE NATIONAL ISSUES TRADE AND CROP BULLETIN

In its excellent twice-a-year publication, the "Trade and Crop Bulletin,"

New and Revised Edition

A Practical Work on Practical Banking **by a Practical Bank Man**

THE latest and best book
on Practical Banking
prepared by an active bank officer of wide
experience, and embodying the methods of
operation employed by the most progressive
banks. Explains in detail the actual work-
ing of each department, particular attention
being given the important subject of banking
credit.

THE PRACTICAL WORK OF A BANK

By **WILLIAM H. KNIFFIN, JR.**, Vice-President
First National Bank, Jamaica, New York City,
Author of "The Savings Bank and Its Practical
Work," "New York Savings Bank Cases," etc.

Contains seventeen chapters and over 600
pages, constituting a comprehensive and
authoritative treatment of all the phases of
bank work.

PRICE FIVE DOLLARS

Carriage Charges Prepaid

THE BANKERS PUBLISHING COMPANY

253 Broadway New York

ADRIAN H. MULLER & SON

55 WILLIAM STREET, Corner of Pine Street, NEW YORK

AUCTIONEERS

The Business of Banks, Bankers, Investors and Dealers in Securities generally, receives prompt and careful attention.

STOCKS AND BONDS AT AUCTION

REGULAR AUCTION SALES OF ALL CLASSES OF STOCKS AND BONDS EVERY WEDNESDAY

Real Estate at Public and Private Sale

Prompt Returns on all business entrusted to us

the Seattle National Bank of Seattle, Wash., deals exhaustively with conditions in Washington, Idaho, Montana and Oregon. The bank gives a very optimistic report throughout, dealing more especially with the shipbuilding, lumber, salmon and fruit industries. Regarding general conditions the bank says:

"At last there has come a generous measure of that business growing out of war and other reviving influences which started on the eastern seaboard in 1915 and has grown to such tremendous proportions elsewhere. So long as the war lasts, tremendous displacements of capital from elsewhere in the world to the United States will continue to take place, and the Pacific Northwest will command a goodly share of this displaced capital, and the great natural resources of our corner of the country are now in demand as never before. Our 1916 agricultural and other food output have sold at prices too well known to dwell upon, and as a consequence our bank deposits are breaking all records. Seattle clearings for the year ending May 31, 1916, were \$653,000,000, and to 1917, same period, \$917,000,000.

"While the grain crops of the Pacific Northwest have passed through some very doubtful periods, it is quite likely that the 1917 wheat crop in Washington, Oregon and Northern Idaho will exceed that of 1916, which totaled sixty-four million bushels. It also looks as if the sixteen million bushels of barley of 1916 will be exceeded and that the thirty-three million five hundred

thousand bushels of oats will be greatly exceeded."

NEW RESERVE BANK BRANCH

A new branch of the Federal Reserve Bank will, in the near future, be organized at Spokane, Wash. Five directors will have charge of the branch, three of whom were designated by the Reserve Bank of San Francisco and two by the Federal Reserve Board. Charles A. McLean, manager of the Spokane Clearing House, will be manager of the branch and chairman of the board.

OLD NATIONAL BANK AND UNION TRUST COMPANY HOLD RECEPTION

Between ten and fifteen thousand friends were entertained at the reception given by the Old National Bank and Union Trust Company of Spokane, Wash., when they opened their newly completed banking quarters.

Officers of the affiliated institutions received many floral offerings and hearty congratulations on the appearance and completeness of the new rooms, where they are now prepared to give a complete banking service "under one roof."

STATEMENT OF CONTINENTAL NATIONAL

The Continental National Bank of Indianapolis in its last statement as of June 20, 1917, shows total resources of \$4,726,636.93 and deposits of \$3,729,353.82. The bank has a capital stock of \$400,000 and surplus and profits

amount to \$69,383.11. Cash assets from cash on hand, bonds and due from banks amounts to \$2,001,612.65.

NEW MEXICO BANKERS ASSOCIATION
CONVENTION

On September 11 and 12 at Las Vegas, New Mexico, will be held the annual convention of the New Mexico Bankers Association. Preparations are being made which will make this convention one of the best in the history of the association.

CONSOLIDATED STATEMENT OF PHOENIX
BANKS

As of June 20, 1917, the Phoenix National Bank and the Phoenix Savings Bank and Trust Company, Phoenix, Arizona, in its consolidated statement showed total resources of \$4,980,309.20 and deposits of \$4,420,360.42. Total surplus amounted to \$150,000 and undivided profits \$213,548.78. Singly the National Bank had total resources of \$3,445,997.47 and deposits of \$2,898,588.94 with a surplus of \$100,000. The Savings Bank and Trust Company showed total resources of \$1,534,311.73 and deposits of \$1,321,771.48 and undivided profits of \$62,540.25, with a surplus of \$50,000. The National Bank has a capital stock of \$150,000 while the Savings Bank and Trust Company has \$100,000.

DEATH OF CHARLES DILLINGHAM

On June, 19, 1917, at Houston, Tex., occurred the death of Charles Dillingham, who for more than twenty-five years served the South Texas Commercial Bank and the South Texas National Bank in the capacity of director, president and chairman of the board.

ANNUAL REPORT OF HOME BANK OF
CANADA

The twelfth annual report as of May 31, 1917, of the Home Bank of Canada with head offices in Toronto shows total resources of \$20,745,829.36 with a paid-up capital of \$1,946,806.33. The bank has total deposits of \$18,332,-

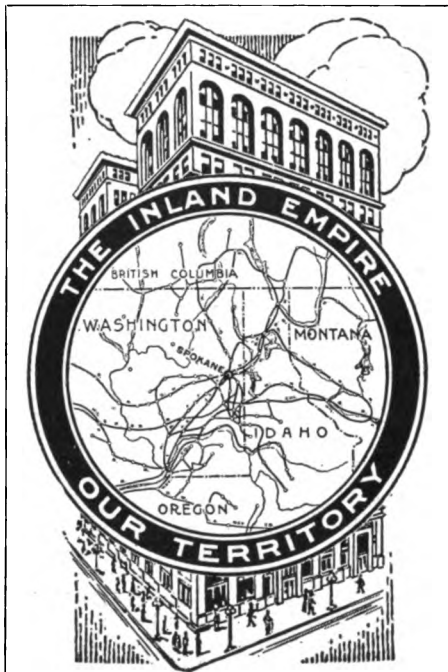

The
Old National
Bank
of Spokane

WITH direct connections in every banking point throughout the "Inland Empire"—a region three times the size of Alabama, of which Spokane is the financial and railroad center—The Old National has the facilities to collect your Pacific Northwest items with exceptional economy and dispatch.

OFFICERS

- D. W. TWOHY, President
- T. J. HUMBIED, Vice-President
- W. D. VINCENT, Vice-President
- J. A. YEOMANS, Cashier
- W. J. SMITHSON
- G. H. GREENWOOD J. W. BRADLEY
- Assistant Cashiers

RESOURCES : \$20,000,000



806.08, of which \$3,360,355.04 is due to Dominion Government. The profit and loss account balances at \$259,994.74. Net profits after deducting charges, interest, etc., amounted to \$217,059.57. The last quarterly dividend of this bank was at the rate of five per cent. per annum.

ANOTHER BANKER JOINS RED CROSS

H. D. Gibson, president of the Liberty National Bank of New York, has been appointed active field head of the 1,800 Red Cross chapters throughout the country. In announcing the appointment Henry P. Davison, chairman of the Red Cross War Council, said:

Mr. Gibson will direct the energies of the 1,800 Red Cross chapters so that the work of all of them can be brought to bear effectively in meeting the constantly increasing need confronting the Red Cross. It will be the purpose of Mr. Gibson to consolidate a great many departments and bureaus which up to this time have been functioning independently and are now to be brought

into co-ordination and directed toward a definite end.

It will be Mr. Gibson's duty to develop chapters and add to the nearly 2,000,000 members the Red Cross already has. It is clear that there is unlimited service and ability in this country which wants to help, and we believe that through Mr. Gibson's efforts a force of tremendous power will be brought into effective action.

There has with perfect reason been some impatience over the lack of direction afforded by the Red Cross for the vast quantity of volunteer effort available. We have been looking for just the man to supply this need, and we believe we have found him in Mr. Gibson. No more important step than this has been taken in organizing the Red Cross for real work in this war.

The new undertaking is a natural culmination of the almost continuous public service of Mr. Gibson since the war began. He went to Europe as head of the committee of bankers that distributed the relief fund sent over on the Tennessee to help the Americans caught in the sudden tide of war to get home. The new executive's headquarters will be at Washington.



How Bankers Are Doing Their Bit

The Citizens Trust Company of Savannah, Ga., has a Liberty Loan Club run on the fifty-week installment plan. One of the officers spoke before a gathering of colored citizens, explained the bonds to them and received a liberal subscription.



The First National Bank of Santa Paula, Cal., a bank with a capital and surplus of \$230,000, took \$10,000 Liberty Bonds on its own account; its officers, directors and employees took \$35,000, and the total subscription sent in through the bank was \$126,250.



The Boston Five Cents Savings Bank of Boston, Mass., received 4,000 applications for Liberty Bonds.

The National Bank of Cortland, N. Y., has a Liberty Loan Club and received 620 subscriptions for the loan, mostly for \$50 and \$100 bonds.



The Quincy Savings Bank of Quincy, Mass., received Liberty Loan subscriptions from 2,562 individuals, amounting to \$172,600, mostly on the weekly payment plan.



The Johnstown Trust Company of Johnstown, Pa., is operating a very successful Liberty Loan Club.



The Logan County Bank of Guthrie, Oklahoma, has turned over most of its officers to the local Red Cross.

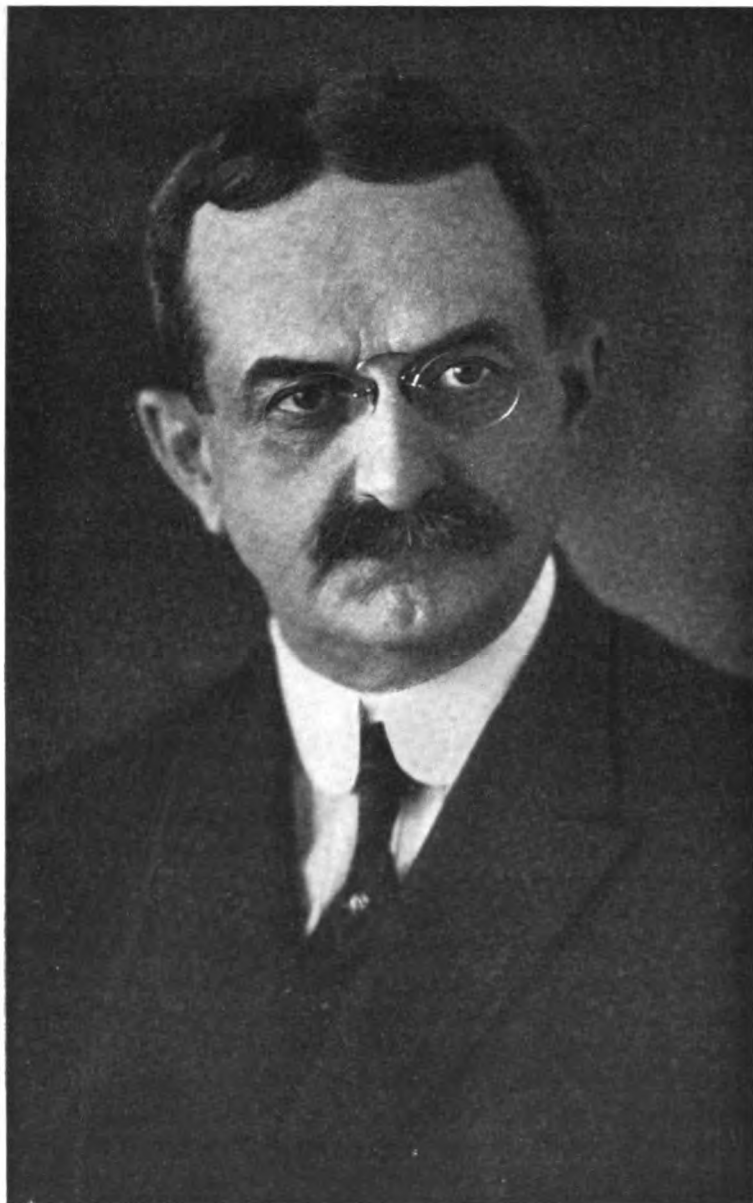

Photo by Oliver Lippincott, N. Y.

HERBERT K. TWITCHELL
President Chemical National Bank, New York

At the age of only fifty-one Mr. Twitchell becomes President of the Chemical National Bank of New York, an institution with nearly a century of existence to its credit and a reputation unique in the history of American banking. Mr. Twitchell's experience with this and other banks gives assurance that under his executive direction the Chemical National Bank will keep abreast of the demands of the times while adhering to the sound principles upon which the present high reputation of the bank has been established.

THE BANKERS MAGAZINE

ELMER H. YOUNGMAN, Editor

SEVENTY-FIRST YEAR

SEPTEMBER 1917

VOLUME XCV, NO. 3

Our Present Task

INABILITY clearly to comprehend the immediate duties of the hour causes many individuals to fail in the struggle of life. They see well enough what is past—where they might have done better yesterday—and think they have clairvoyant powers in charting out the reefs and quicksands of the future. But as to what lies right before them, the immediate duty of the hour or moment, they are incapable of comprehending anything.

To such impracticable class of mortals belong those who are now engaged in refashioning the world after the war.

They have ready at hand their arbitration courts, their peace leagues, and every detail of the international paraphernalia warranted to recast mankind in some nobler mould which will make all future wars impossible.

But what they utterly fail to see is that the war is not yet ended, and that until then all discussions of this character are as futile as would be the proposal to plant a colony in the moon in the absence of means of travelling to that planet or information as to its suitability for the enterprise.

Our present task is not to refashion the world, but to hold in check and finally to overcome those forces which have brought about this awful cataclysm. That is the duty which lies close at hand, and is the one to which each one should address himself with inflexible purpose, refusing absolutely to be diverted from this object by any alluring dream of the future.

When those who have made the world the awful theatre of human carnage which it is to-day are put in a position where they must make full expiation and reparation, so far as that is now possible, and when they are forever rendered incapable of inflicting a like calamity upon the human race, then and then only will it be time to begin to think of practicable means for international economic

coöperation and for a more rational way of settling international controversies than by a resort to war.

It is a fascinating employment to draw up a constitution for a federation of nations, to create a court whose wise and impartial decrees will universally be accepted, to disband armies and to dismantle navies. Some day, possibly, this may be the work of the practical statesman instead of a dreamer's idle speculations, but until that time comes, and until the first essential to its practicability—the utter defeat of our foes—shall be accomplished, to discuss these problems is a mere waste of time.

There is one immediate duty before us of overwhelming importance. That is to defeat Germany. Until that is done we have no warrant for discussing the world's future.

GIVING UNGRUDGING SUPPORT

IN this hour of national trial those charged with the burden of administering public affairs need the complete coöperation of every citizen. Upon the shoulders of the President falls the heaviest load. As the selected leader of the people, it becomes his duty to assume the major responsibilities of the hour, to carry into execution the popular will. His policies may not in every case be the wisest that could have been chosen—time will determine that—but they were deliberately entered upon, in the belief that they were the best, and whatever individual opinion each one of us may have, let us all hope and believe this will be so. Most of the differences are over details, anyway. We all recognized, for example, that an army must be raised, though many favored the volunteer system, while others thought the draft necessary. All of us know that immense sums of money must be found, whether the greater part by taxation or by bond issues, is again a detail. Some advocate wooden ships, some steel; but all want ships of some kind. One body of citizens demands that our efforts be concentrated on aëroplanes, another insists on torpedo boat destroyers, but both classes want something that will help defeat the enemy. Many thought the training-camps should have been located in the North, where it is cool; others, in the South, where it is warm. Nobody denies the necessity for training camps somewhere. And as to food control, every thoughtful person understood that it must be exercised in some form, but whether by a single administrator or by a commission, opinions differed.

Discussion of these details of administrative methods have their

value while the measures are pending, but once decided on, all discussion ought to end. The motto then should be, get busy and do the very best we can with the tools we have.

Let us all give to the Government, to its sorely-burdened officers, the most ungrudging support.

PATRIOTISM AT ATLANTIC CITY

WHEN the American Bankers Association assembles in the week of September 24 for its annual convention at Atlantic City, no doubt the dominant note will be "rally 'round the flag." It is a good slogan for the times, and the bankers show their keen discernment as well as their patriotism by putting it to the fore.

There are weak and flaccid souls, men of putty, who go about timorously asking, even yet, "What are we fighting for?"

If among these pigeon-livered persons there are any bankers, and they will go to Atlantic City this month and attend the convention, they will get a pretty clear idea there as to what we are fighting about, for the story will be told by strong and forceful men in language so plain that the wayfaring man though fool will be able to understand it.

There will be representatives present from all sections of our common country: from New England, with its magnificent historical traditions; from the Eastern States, mighty in commerce and finance; from the South, whose patriots were foremost in the work of creating and establishing the foundations of the republic; from the great Middle West, the most typically American region in all the land; from the golden Pacific shores, where there is spread out before the gaze of man a vision of wealth and beauty to dazzle the wildest imagination—and all these shall speak with one accent the language of patriotism.

Often the criticism has been heard that the proceedings of the bankers' conventions are dry and prosy; there are routine reports, long economic essays and other mental food unsuited to the one whose intellectual taste does not rise much above the average level of the "movies." But this year's convention will be alive with the earnest discussion of subjects vital to our country, and there should be few dull moments. Certainly there will be strong, earnest, patriotic speeches from men whose words fitly spoken are like apples of gold in pictures of silver or as the shadow of a great rock in a

weary land. To hear them will not resolve your own doubts about the war, for you as a full-blooded American have no such doubts; but they will reinforce and reaffirm your own already strong convictions of the righteousness of our position and the certainty of victory, so that you as a banker and as a citizen can go to your home from Atlantic City taking with you renewed courage and fresh devotion to work in your own community, among your own people who know and trust you, for the cause to whose triumph every one of us is solemnly pledged.

There should be a great popular outpouring of bankers at Atlantic City—a getting together of men from all sections—to speak now in a voice so strong and unanimous that they who hear will understand and long remember.

RECORD FIGURES FOR THE NATIONAL BANKS

COMPILATIONS of the latest returns from national banks, showing the condition of those institutions on June 20, place the national banks at the highest position ever reached in point of total resources. Under the present abnormal conditions these record figures are to be explained by other causes than the growth in the ordinary business of the banks. Temporary war orders, Government loans, high prices, and the expansion which diminished reserve requirements permit, are a few of the principal influences operating to swell bank totals.

The call of June 20 was the last which will be made under the old reserve requirements. The new law recently passed requires all national bank reserves to be carried with the twelve Federal Reserve Banks.

The total reserve held June 20, 1917, was 2,310 million dollars, a reduction as compared with May 1, 1917, of 163 million dollars, and an increase as compared with June 30, 1916, of 234 million dollars. The percentage of total reserve to deposits June 30, 1917, was 22.91 as compared with 24.05 per cent. May 1, 1917, and with 23.86 per cent. June 30, 1916.

The surplus reserve over and above the amount required on June 20, 1917, was 842 million dollars, a reduction as compared with May 1, 1917, of 132 million dollars, and an increase as compared with June 30, 1916, of 41 million dollars.

The total reserve carried in vaults and with Federal Reserve Banks June 20, 1917, was 1,482 million dollars, which was 14 million

dollars in excess of the total amount of reserve required, therefore the banks on the date mentioned held in their vaults and with Federal Reserve Banks 14 million dollars more than the amount required in addition to the 828 million dollars reserve carried with the reserve agents.

On June 20, 1917, the central reserve cities held 19.70 per cent. of reserve against a required reserve of 18 per cent. Other reserve cities held 22.45 per cent. against a requirement of 15 per cent., while the country banks, which were only required to carry 12 per cent., held on June 20, 1917, a reserve of 25.33 per cent. of their net deposits.

The fact that banks in "other reserve cities" and the "country banks" carry a much larger excess of reserves than the central reserve city banks is worth noticing. It will be seen that on the date named the banks in the central reserve cities were close to the limit of their reserves, while the banks in "other reserve cities" and the country banks had a considerable margin in both cases. Possibly these two classes of banks regard their reserve more or less in the light of till money, which they may need at any time and can not so quickly replenish as can the banks in the larger centres. Perhaps from this standpoint they are right. The use of checks is less highly developed in the country than in the larger cities, and therefore banks in these cities really need a smaller proportion of currency for till purposes than do the banks in the country and in the smaller cities. The law of reserves, however, proceeds upon the principle that the very magnitude of the operations of the large city banks, the important relations they sustain to banking and business in general, and especially to international finance, call for larger reserves.

Under a proper system of banking the necessity of holding the large amounts of reserves which the "other reserve cities" and "country banks" report purely with the thought of being adequately provided with till money, would be obviated. Currency supplies would not run out so long as there were cashiers' checks on hand, engraved in the likeness of current money. This does not mean that a bank should hold any less reserve against its notes than against its deposits, but it does mean that certain classes of banks should not be required to hold, for purely till money purposes, larger amounts of legal tender than other classes of banks are required to hold. Apparently, the intention of the law in regard to bank reserves is being reversed in practice, and although the "other reserve city" banks and the country banks may, under the law, hold much smaller reserves than the banks in the central reserve cities, they nevertheless feel it necessary for their own protection to hold much larger reserves.

This is the penalty which the numerous banks of the "other reserve cities" and the vastly more numerous "country banks" must pay for having failed to give that attentive study to the banking reserve problem which its importance deserves.

A SUGGESTED ECONOMY

WHILE the Government is very properly admonishing all citizens to practice a wise economy, may it not likewise be permissible for the citizens to suggest that the Government also do what it can to reduce unnecessary expense?

It was stated some years ago by the late Senator Aldrich, who was a most capable business man, that the Government was annually expending an enormous sum—\$300,000,000 if memory serves—unnecessarily, on account of lack of proper methods.

Without attempting to cite the numerous points at which Government saving might be effected without any lessening of efficiency, but with a possible gain, let us for the moment be content with a single instance.

Reference is made to the various kinds of paper "money" or currency now in use in this country. These are gold certificates, silver certificates, the old "greenbacks" Treasury notes, national bank notes, Federal Reserve notes, and Federal Reserve Bank notes.

Were there any essential difference between any forms of these notes, their perpetuation might be justified, but there is none; there are distinctions without differences, but in their fundamental qualities all these various kinds of paper instruments are the same, for the simple reason that each one entitles the holder to receive an equivalent in the standard coin of the country, which is gold.

Every banker understands quite well, of course, the particular kind of security behind the respective kinds of notes, and therefore no necessity exists for entering into that phase of the subject. What is important is this, that in law and in fact each kind of paper representative stands, in the final analysis, for so many dollars in gold. No argument is necessary to show that things that are equal to the same thing are equal to each other, and that is the case with all our forms of currency as respects their real value, whatever declarations may be printed on the notes, and irrespective of the special uses to which certain forms of these notes may be put.

Every dollar of outstanding currency in the United States today is worth exactly its face value in gold coin, no more and no less.

In making this statement, manifestly some of the old state bank notes still outstanding are excluded.

All of our money to-day is Government money, whatever its face may import; and the Government, by express statute, either directly or indirectly, is pledged to its redemption in gold.

If this statement be correct, what excuse exists for perpetuating the various kinds of currency with the expense necessarily involved, and to the benefit of nobody, except possibly those who are paid for engraving and printing the notes? This is a most expensive form of labor, for it requires much time and a high degree of skill. The various kinds of currency are issued in several denominations, thus multiplying the labor and cost.

All the kinds of paper above enumerated could be dispensed with, save two—gold certificates and Federal Reserve notes. Indeed, the gold certificate, although an excellent form of currency, is becoming nothing more than a banking convenience. In other words, the Treasury is providing warehouse facilities, at public expense, for the convenience of the banks. But there is another phase of this matter. So strong is the popular belief in the Government as the custodian of the "ultimate money of redemption," that it is very doubtful if it would be wise to disturb this confidence by taking the gold out of the Treasury vaults. Except for this sentiment, the gold might just as well as not be deposited with the clearing-houses at the principal money centres.

Federal Reserve notes will have to be preserved, under the existing banking system.

All the other forms of paper, which cost the people large sums annually for engraving and printing, could be gradually dispensed with, thus saving a substantial amount of money every year and at the same time simplifying the forms of currency in circulation, greatly to the public convenience.

CHANGE IN THE FORM OF BANK STATEMENTS

FUTURE calls for statements from the national banks will not include reports in detail of the kinds of money held by the banks according to the schedules heretofore used. In making the announcement of this change, the Comptroller said:

"Except when needed for statistical purposes, probably once a year, national banks will only be required to report in their periodical statements of condition to this office the money in their vaults

under the following heads: Gold coin, silver and minor coins, clearing-house certificates based on specie and currency (section 5192 U. S. R. S.), paper currency.

“Under the head ‘paper currency’ the national banks will include all gold certificates, silver certificates, national bank notes, Treasury notes, United States notes, Federal Reserve notes, and Federal Reserve Bank notes.

“When it is desired to secure from the banks a more detailed statement as to their cash holdings for statistical purposes, sufficient notice in advance will be given them to make preparation for supplying such data. It is believed that this ruling will materially reduce the labor of receiving tellers and other bank employees.”

Doubtless “receiving tellers and other bank employees,” considerably burdened of late in endeavoring to satisfy the apparently unappeasable hunger of the Comptroller’s Bureau for information, exclaimed on reading the Comptroller’s announcement, “For this relief, much thanks.”

To the student of economics the amount of gold held by the banks on any given date is a matter of at least academic interest, and to the banker whose business it is to watch with concern the rise and fall of the tides of money and credit flowing through the banks, the amount of gold which these institutions have is also a matter of practical interest. But it is very much doubted if the average citizen dealing with a bank pays much attention to the amount of gold in its vaults. A great many bankers are not much more concerned about their gold holdings.

It would be quite correct to say that this is beside the point, and that whatever the average person or the average banker may think on the subject, there is an important reason why the banks should, as a whole, keep on hand very substantial amounts of gold. No one doubts that many of the largest and strongest banks have long been guided by this principle, as they will continue to be in the future.

For statistical purposes purely, where it is desired only to make comparisons for periods of six months or a year apart, statements of the gold holdings of the banks at the intervals named by the Comptroller as indicating future requirements will be sufficient. The question arises, however, whether in these times of extreme and rapid fluctuations in banking totals it is not desirable to be able to make comparisons of the gold holdings of the banks at more frequent intervals than would be possible with only semi-annual or annual reports. That is a matter to which the Comptroller of the Currency has doubtless given due consideration and has acted in accordance with his judgment.

The actual gold in the vaults of the banks is decreasing, and for very obvious reasons. In the first place, the amount of reserves

of any kind which the banks are required to hold has been greatly reduced under the Federal Reserve Act, and the location of legal reserves has been changed altogether from the vaults of the banks (that part of it which was previously so held) to the Federal Reserve Banks. But not only has there been a reduction of gold holdings on account of changes in the location and amount of reserves held, but the character of cash which the banks keep on hand has been changing also, principally on account of the increase in the volume of Federal Reserve notes.

Has it ever occurred to the Comptroller of the Currency that the tellers and other employees of banks could be relieved of the extra work involved in reporting the various kinds of the currency they hold if the Government would quit issuing so many varieties?

THE OTHER HUNDRED MILLION

WHEN the results of the first Liberty Loan were summed up, everybody naturally felt gratified that so many people had participated in it. The people of the United States had practically been without the necessary experience that would qualify them to take part in subscribing for a great popular loan. Civil War days were far away, and the experience gained in the Spanish-American War was hardly extensive enough or so recent as to be of much value in the present emergency. All things considered, the people of the United States made a splendid response to the Government's appeal for funds, though the number subscribing here was much less than in England, although judged by the population and wealth our subscriptions should have been much larger. On the other hand, it must be remembered that England has been at war much longer than we have, and besides has a large body of citizens who from long habit are accustomed to the art of investing.

The fact remains, however, that with practically the best security on earth offered them at a fair rate of interest, and with strong patriotic incentives, there were some one hundred million of Americans out of a total population of one hundred and three million that did not subscribe for the first issue of Liberty Bonds. They were not prevented because of lack of funds, for the bonds were offered on such attractive terms that persons of very modest incomes could have bought at least a \$50 bond on installments.

It would seem that making allowances for children, the very

poor, imbeciles, etc., there ought to have been at least 50,000,000 subscribers to the Liberty Loan.

Why did not more people subscribe for the loan? They were asked to do so by a very strong publicity campaign, and by personal appeals made by the Secretary of the Treasury, prominent bankers, and others.

The apparent indifference of so many people in regard to the Liberty Loan was due to the fact that until the past few months we have never really understood the importance of creating among the great body of the people the desire to become investors on their own account. We have not needed to raise great public loans, and the railway, industrial and municipal loans were placed mostly among banks, trust companies and savings banks. The investment houses, while selling securities to the public in a modest way, depended largely upon the institutions named as buyers of the securities bought in the first instances by the bond houses.

We are now confronted with a vastly different problem, namely, to find a market that will quickly absorb bond issues in a volume heretofore undreamed of, and we must with as little delay as possible educate the public to understand both the desirability of Government bonds from an investment standpoint and the propriety of investing in them on patriotic grounds.

FURTHER EXTENSION OF GOVERNMENTAL BANKING

NOT many years ago among currency reformers there was a more or less popular slogan about "taking the Government out of the banking business." Amiable bankers there were in plenty, and perhaps some financial editors, who really thought that this was one of the things certain to happen. What actually did happen those who have recovered from the shock know well enough. The Government went into the banking business to an extent which hardly the most radical would have thought possible. The Federal Reserve Act, the Federal Farm Loan Act and the Postal Savings Bank Law—all committing the Government to an extensive participation in banking in some form—are the instrumentalities employed to bring the banking services of the Government to the people.

Now it is proposed to enlarge the activities of the Postal Savings Bank by removing the present limitation on deposits (\$1,000

at interest from any one individual and \$1,000 without interest) and also to extend the operations of these banks in other ways. These proposals are found in a bill introduced in the United States Senate by Senator Sheppard of Texas. In brief, the suggestion is to "unshackle the Postal Savings Bank." That this suggestion contains some exceedingly interesting possibilities for the ordinary banks of the country will appear from an examination of the details of Senator Sheppard's bill.

Not only is it proposed to remove the existing limitation on individual deposits in the Postal Savings Bank, but the activities of that institution are immensely widened. Rural mail carriers are to collect and bear deposits to them, and also to receive checks on them and to distribute the money among the farmers. Loans are to be made on real estate, on other approved collateral, and on personal security also. The profits derived from the banks are to be turned over to depositors after administrative expenses are deducted. There are many other details of the plan which would require considerable space to analyze.

Senator Sheppard stated in presenting his bill that in the State of Victoria, Australia, and in the State of Connecticut some fifty per cent. of the population were depositors in savings banks, and that with this ratio in the United States the "unshackled Postal Savings Bank" would have from forty-five to fifty-five millions of depositors; and with the same ratio of deposits to population as is maintained by the savings banks of New York city, "the United States Postal Savings Bank would have deposits of anywhere from twenty-seven to forty-seven billions of dollars."

We do not know what form of banking mathematics the Senator employs to arrive at this conclusion. He seems to think that merely by providing unlimited facilities for receiving deposits they will flow in to an extent also practically without limit. Bankers could tell him the fallacy of this belief.

He goes on to say that with all this vast sum at its disposal the Government might easily have financed the recent bond issues and others authorized but not yet issued.

Senator Sheppard evidently does not contemplate wiping out existing banks altogether, for he provides that they may receive a commission for acting as agents for the Postal Savings Bank, thus reducing them to a point where they are brokers rather than bankers.

The possibility that the scope of the Postal Savings System may be widely extended is not so remote as some may imagine. There exists a necessity for raising immense sums of money, and having seen the advance already made in the banking business by the Government, and the still more remarkable assumption of powers in other directions, it would not occasion great surprise should some

such "unshackling of the Postal Savings Bank" as that proposed by Senator Sheppard take place.

The existing banks are quite generally safe, but on that score they would not find it easy to compete with the Government, for the confidence of the people in the stability of the Government approaches the absolute. If, in addition to its unassailable record for safety, the Government should offer the incentive of interest rates substantially as high as those offered by the ordinary savings banks, the latter would have a hard struggle to retain their deposits in competition with the Government.

In looking back over the field of banking development in this country for the last twenty-five years, one cannot escape the reflection that remarkable as that development has been, it has lacked some of the advantages that might have flowed from a more intimate acquaintance with the broad aspects of banking on the part of the bankers of this country as a whole. This lack of trained economic knowledge and the failure to comprehend what seem elemental aspects of our banking problem have been responsible for the already great extension of Governmental activity into the field heretofore occupied by the banks and the threatened inroads of even greater extent.



The Refunding Mortgage

A Amortizing Method for Small Mortgage Loans

By ED. L. DAVIS

THE practice of savings banks and similar financial institutions that make small loans on the homes of the people is usually wanting in respect to a satisfactory and definite policy as regards the amortizing of the principal. Generally a clause in the mortgage agreement provides for the acceptance of partial repayments upon interest day anniversaries, but so long as the interest is promptly paid and the security unimpaired, the mortgagee ordinarily evinces no desire for having the principal reduced.

In the matter of partial repayments, they are commonly left optional with the borrower, who, in the majority of cases, and in the absence of any obligatory requirement, makes no effort to lessen his principal obligation. There may be a reason, although not a valid one, for neglecting to take advantage of this intermittent means for the liquidation of his indebtedness. The amounts stipulated as being acceptable or their implied dimensions, while small in comparison with the principal sum, are frequently beyond the financial capacity of the borrower at the specified times of their acceptance, because he has not seen fit to anticipate the events by conserving smaller sums, well within his means, during the anniversary intervals.

Usually the borrowers on this type of loan are wage earners with more or less regular incomes, and if some method be adopted that conforms to these circumstances and corresponds, in a measure, with the periodic flow of this revenue, a solution will have been consummated.

A process to commend itself must be

practicable, easily comprehensible, and with sufficient latitude to conform to the varying exigencies of the borrowing participant.

The installment plan employed by savings and loan associations furnishes an example for imitation, with such improvements over their existing methods as experience has found desirable. In these bodies the installment payment is a fixed one which continues for an indefinite time until the maturity of shares. With them, this payment is made up with the sum due as payment on the shares combined with the relative portion of the interest computed on the entire amount borrowed.

It is evident that this method of arriving at an installment payment is lacking in scientific and even equitable basis, for in all of these installment payments, subsequent to the first, the interest portion is in excess of the requirement.

LOAN ASSOCIATION PRACTICE

A brief review of loan association practice will aid in a better understanding of this proposed installment plan and, by comparison, reveals its operative superiority.

A loan association usually charges a fee for admission, exacts fines from delinquents, deducts losses, if any, from earnings, and nearly all of them will permit withdrawals only at a sacrifice of profit, which in some cases is considerable. A borrower from one ordinarily has no definite contract and the uncertainty as to the time it will take to repay his loan leaves him in ignorance as to its ultimate cost. There is no entirely satisfactory provision for

FIGURE 1.

Davis's Installment Mortgage Plan.—Monthly Payments on a \$1,000 Loan.—Monthly Installment Principal \$10. Interest, Six Per Cent.

No.	Payment	No.	Payment	No.	Payment	No.	Payment
1	15.00	26	13.75	51	12.50	76	11.25
2	14.05	27	13.70	52	12.45	77	11.20
3	14.00	28	13.65	53	12.40	78	11.15
4	14.85	29	13.60	54	12.35	79	11.10
5	14.80	30	13.55	55	12.30	80	11.05
6	14.75	31	13.50	56	12.25	81	11.00
7	14.70	32	13.45	57	12.20	82	10.95
8	14.65	33	13.40	58	12.15	83	10.90
9	14.60	34	13.35	59	12.10	84	10.85
10	14.55	35	13.30	60	12.05	85	10.80
11	14.50	36	13.25	61	12.00	86	10.75
12	14.45	37	13.20	62	11.95	87	10.70
13	14.40	38	13.15	63	11.90	88	10.65
14	14.35	39	13.10	64	11.85	89	10.60
15	14.30	40	13.05	65	11.80	90	10.55
16	14.25	41	13.00	66	11.75	91	10.50
17	14.20	42	12.95	67	11.70	92	10.45
18	14.15	43	12.90	68	11.65	93	10.40
19	14.10	44	12.85	69	11.60	94	10.35
20	14.05	45	12.80	70	11.55	95	10.30
21	14.00	46	12.75	71	11.50	96	10.25
22	13.95	47	12.70	72	11.45	97	10.20
23	13.90	48	12.65	73	11.40	98	10.15
24	13.85	49	12.60	74	11.35	99	10.10
25	13.80	50	12.55	75	11.30	100	10.05

making larger payments than the required ones and thus shorten the time of maturity. Any advance payments, when permitted, are sometimes allowed a small discount, but the time to maturity is not abridged thereby. This refers to small payments, multiples of the installment; where large ones are made, to be applied upon the principal, the involved procedure required is explained in the following paragraph:

In these organizations, after much computation each month, or perhaps only semi-annually, a borrower is informed of the holding value of his shares, which may be a gratification to him if he has no desire to make a partial or entire settlement of his loan. Should he elect to repay a portion of his mortgage principal and thus reduce the amount of his monthly payment, he will be obliged to withdraw the required number of shares, at their withdrawal value, usually less than their holding value and take out a new loan for the balance outstanding, an operation attended with additional expense aside from the loss of profits.

The average member is generally unable, for himself, to determine his exact financial position at all times. Furthermore, at the stated periods when he is

made acquainted with such, as a shareholder, it is frequently an idealization and not a realization of which he can take advantage.

In the matter of fines for delinquents some associations have a cumulative feature that compounds them at each recurring lapse of payment so that a delinquency of a few months may wipe out the profits of years; still others have a practice of charging the delinquent borrower double the amount of the fine that is exacted from the delinquent investor; in fact, in some instances the amounts so exacted are out of all proportion to the character of the default and border on the nature of a penalty.

A BETTER PLAN

With the proposed installment plan here presented, punitive methods are not required for its successful operation, as any lapse of payment carries with it its own compensative measure, which is covered by the interest charge only for the time elapsed during the default.

The plan, in brief, consists in repaying monthly $1/100$ of the mortgage principal with interest at six per cent. on the balance of the loan outstanding, the borrower being permitted to make

as many multiples of the monthly principal payment as he may elect, so that while the maximum time required for the repayment of the loan is 100 months, advantage being taken of this optional feature will shorten this time and reduce the consequent interest cost. A default in payment exceeding six months makes the whole balance of the loan due and payable. There are also other features brought out in the accompanying accounting which has been standardized and is facilitated by the employment of suitable tables and appropriate forms.

Figure 1 is a tabulation of the monthly payments required on a \$1,000 loan, serially numbered, the amounts being the sum of the installment principal and one month's interest on the balance of the loan outstanding. A copy of a similar tabulation, corresponding to the amount of the loan, is attached to each mortgagor's pass-book for reference as to the exact payment required at any given period.

FIGURE 2.

THE DIME SAVINGS BANK

No. 17		In Account with		Signature of Payee
		JOHN SMITH.		
		Loan of \$1,000.00		
1906		No.	Payment	
Date				
Jan.	2	1.....	\$15.00	F. L. T.
Feb.	1	2.....	14.95	
Mch.	2	3.....	14.90	
Apr.	1	4.....	14.85	
May	2	40.00	
May	2	5.....	14.80	
June	1	10.....	14.55	
July	2	11.....	14.50	
Aug.	1	12.....	14.45	
Sept.	2	13.....	14.40	
Oct.	1	14.....	14.35	
Nov.	1	15.....	14.30	
Dec.	2	90.00	
Dec.	2	16.....	14.25	
1907				
Jan.	2	26.....	13.75	
Feb.	1	27.....	13.70	
Mch.	1	28.....	13.65	
Apr.	2	29.....	13.60	
July	1	7.10	
July	1	30.....	13.55	
Aug.	2	31.....	13.50	
Sept.	1	32.....	13.45	
Sept.	29	33.....	13.40	
Oct.	2	34.....	13.35	

Figure 2 shows a page from a pass-book for a \$1,000 loan and it affords a typical illustration of the manner of its procedure and how it operates to

conform to the varying financial conditions of the borrower. It will be noted that the payments have been made in regular order until May. At this time the mortgagor, having extra funds at his disposal to apply upon his account, makes four principal monthly payments of \$40, duly credited as shown, in addition to his fifth regular payment of \$14.80. Having thus anticipated the next four payments, the interest thereon is saved and the next payment becomes No. 10. Continuing on from this in regular sequence until December, another improvement in his financial circumstances permits him to make a payment of \$90, the equivalent of nine principal payments, in addition to the regular installment, No. 16, then due, of \$14.25. This procedure makes the next payment No. 26, and thereafter payments regularly progress until April, when a lapse of two months occurs, such as might be occasioned by illness or other cause absorbing the surplus income during the interval. The only exaction for this default is the interest charge for two months on the balance of the loan outstanding, now \$710, amounting to \$7.10. The regular payment at this time, No. 30 of \$13.55, is also made, which brings the accounting to date.

From this on regular payments are indicated, but enough has been shown to demonstrate how fully the plan meets all requirements and how readily it accommodates itself to any financial condition that may be temporarily experienced by the borrower.

The maximum interest cost to a borrower, assuming that the full time, 100 months, is consumed in the repayment of the loan, is \$252.50. This makes a nominal interest rate of three per cent. for the eight and one-third years' duration of the loan.

Savings and loan associations that sell their \$100 par value shares for fifty cents per share monthly and loan their funds at six per cent., usually take 141 months for maturity. A borrower from them in this case would thus pay \$10 a month on a \$1,000 loan, making the total accumulated payment \$1,410,

exclusive of any fees, premiums, fines, etc., that may be exacted during the interval of repayment. The excess paid above the \$1,000 borrowed is \$410, and represents the interest cost for the period. This is equivalent to a nominal interest rate of three and one-half per cent. for the eleven and three-quarters years.

The comparative benefits to be derived from the operation of this plan by the respective parties thereto may be summarized accordingly.

ADVANTAGES TO THE BORROWER

(1) He has a positive and definite contract with the loaning institution, and he not only knows the exact amount of the ultimate interest cost, if he conforms to all the requirements, but also for any departures therefrom.

(2) By the payment of so small a sum monthly upon the mortgage principal, he gradually reduces the debt to its final extinguishment without apparent effort.

(3) The acceptance by the mortgagee of any multiple of the monthly installment principal gives him more frequent opportunities of taking advantage of any improvement in his financial condition to decrease the amount of his indebtedness and the consequent interest charge.

(4) The gradual reduction in the amount of each succeeding installment gives constant, visible and satisfactory evidence of the reduction of his obligation.

(5) The absence of any penalty in default of payment.

ADVANTAGES TO THE LOANING INSTITUTION

(1) The maximum rate of interest is received.

(2) The constant reduction of the mortgage principal makes the security continually better.

(3) The receipt of interest twelve times a year instead of twice, as ordinarily.

(4) Larger earnings from the augmented interest charge.

In the consideration of such a departure by a financial institution from its usual practice in mortgage loans, the benefit to be derived is apparent. Those that allow but three and one-half per cent. to their depositors and that receive five per cent. on mortgage loans, could, by the adoption of this plan, with its six per cent. interest rate, which increases the interest charge by twenty per cent. on this class of loans, be able to increase the dividend to depositors to four per cent. Those that now allow four per cent. would be assured of the maintenance of this rate. Loan associations lending money at six per cent. pay investors from four and one-half per cent. to five per cent.

The peculiar and practical features of this plan may be summed up as follows:

The lender receives the highest rate of interest.

The borrower can well afford to pay this rate in return for the privileges granted to him, for after all the rate of interest is incidental, the factor to be ultimately considered being the total interest cost for the actual time involved.



Report on Liberty Loan Publicity

GUY EMERSON, secretary of the publicity committee of the Second Federal Reserve District, has submitted to Frank A. Vanderlip, chairman of the committee, the following report on the publicity work accomplished during the recent Liberty Loan campaign:

On May 8 the committee was appointed and the first meeting held. Those present were the chairman, Martin Egan; W. S. Kies, and Guy Emerson. At that meeting a tentative discussion of the publicity plans was held. At a later meeting the same afternoon a typewritten outline was presented covering the various organizations to be reached. This outline was formally approved by you the following day after consultation with the general committee. It may be said briefly that all the plans proposed in this schedule were carried out.

On May 9 informal authorization was received from the Federal Reserve Bank to occupy a small portion of the space in the rooms 518-521 Equitable building, vacated the previous night by the Belgian Relief Commission. Our committee was the first on the ground and personally moved in furniture, consisting of deal tables and chairs, and commenced operations. We maintained this same location until the campaign formally ended on June 15. Owing to the nondelivery of buttons, ten of our force were held over until June 25 to distribute the balance required by subscribers.

STAFF

The office staff varied from sixty to one hundred persons. All but two of these were lent by various banks and bond houses. The office management was in charge of R. C. Mees, of J. P. Morgan & Co., whose skill and patience were largely responsible for the fact

that the great amount of work done by a constantly changing volunteer staff in very congested quarters did not result in chaos.

DISTRIBUTION

Through this office were distributed circulars and application blanks, application cards, partial payment booklets, reprint of speeches and editorials, posters, etc., sometimes in large quantities, sometimes in small, amounting to approximately 8,000,000 pieces. In addition to this we distributed 1,412,000 Liberty Loan buttons. The mail that went out of the publicity office to banks, newspapers, etc., amounting to several thousand pieces a day, consumed 75,000 two cent stamps. Nearly 200,000 postal cards were used. The news department issued to each of the morning and evening papers from five to thirty-five typewritten sheets daily.

As an indication of the activity of the office it has been ascertained from the New York Telephone Company that the outgoing calls from the Liberty Loan headquarters during the period when the publicity committee was in occupation amounted to approximately 15,500, or an average of over 400 a day.

EXPENSES

The committee was hampered at the outset by the inevitable uncertainty which surrounded the budget situation. Obviously, \$10,000 early in a campaign can be more effectively used, for posters for example, than can five times that amount of money towards the end of a campaign. We were not given even an approximate idea of the amount of money which would be available for publicity until the work was half over.

We were moved also by a desire to avoid the extravagance which is so easy

under such circumstances. The results are reasonable satisfactory in view of the necessity we were under of organizing many committees on a national basis at the request of the Treasury Department. Much of the literature we published was in heavy demand in other districts and inasmuch as this was a national campaign we were loath to refuse the many urgent requests we had from even as far west as San Francisco.

The final audit of our expenses has not yet been completed, but it is already clear that our total expenses, including our share of the rent both in the Equitable building and at 50 Wall street, and including also a great deal of printing which was done for other committees, will be under \$90,000. The total expenses in the district, for publicity alone, are estimated at \$750,000.

SCOPE OF WORK

As the members of the committee are reasonably familiar with the points of contact of the publicity committee, I will not cover this matter in too great detail. It may be said in general that our plan of action involved working almost entirely through existing organizations.

The publicity machinery of the United States is doubtless the best in the world. The official associations of actors, authors, advertising men, automobilists, bankers, brokers, traveling salesmen, insurance men, hotel men, fraternal organizations, social and other clubs, women's organizations, Boy Scouts, home defense leagues, the National Security League and other preparedness organizations, chambers of commerce, boards of trade and merchants' associations, labor organizations, churches, schools, colleges, daily and weekly papers, financial papers, magazines, farm and trade papers and many other effective groups offered their services in this patriotic cause without reservation.

It was not thought advisable to put representatives of these committees actually on the publicity committee and

the soundness of this early decision was borne out by our experience. It would have been very difficult to have selected one such representative without selecting all. There are a great many very powerful organizations, national in scope, which would be quite competent to handle a considerable part of the work of placing a large loan fully as well as the bankers and brokers handled it in this instance. But it has been suggested to representatives of all the organizations with which we have come in contact and which did such generous and effective work, that, having been appointed by the Federal Reserve Bank at the request of the Secretary of the Treasury, this committee must assume responsibility for results. The Liberty Loan Committee did not desire to expand itself into a complete and inclusive corporation to handle the Liberty Loan, but it is simply an executive committee the object of which is to mobilize ALL the existing agencies in the district and to bring their forces to bear upon the particular portions of the public with which each is most familiar.

CO-ORDINATION

To form the connecting link between the Liberty Loan publicity committee and each of the organizations which was helping, one man as far as possible was assigned to each branch. To show the character of work done four examples may be cited as representative:

1. NEWS

J. I. Clarke, formerly of the New York "Sun," and now with the National Bank of Commerce in New York, was placed in charge of supplying the papers with news. In his report to the secretary of the committee Mr. Clarke says: "The press room was organized under my direction along the general lines of the city room in a daily newspaper. My relation to it was that of a managing editor, reporting to you as publisher. Mr. Caldwell, of 'The Globe,' was city editor, and the reporters, loaned by different newspapers, worked under his general direction.

The newspaper stories were issued on the typewriter and the mimeograph.

"We had a perfectly appointed city desk, with reference books, telephone, dead hook, date book, assignment book, and daily schedule. The stories were ready for the newspapermen at 11 a. m. and 4 p. m. each day.

Personnel—"The reporters were given regular assignments, either by Mr. Caldwell or by me through Mr. Caldwell. The stories were covered in the usual newspaper fashion and turned out in newspaper style. The following newspaper people worked regularly in the press room: Gurden Edwards, Associated Press; Leonard Smith, 'The New York Times'; E. R. Caldwell, 'The Globe'; P. F. Hanley, 'The Sun'; Milton Bronner, Scripps-McRae News Service; Mrs. Lewis M. Isaacs, 'The Evening Post'; Joseph R. Lissen, 'New York American'; J. W. Workman, 'New York Tribune'; John Kirby, 'The World', and J. W. McConaughy, 'The Evening Mail.'

"I have estimated that we had fifteen thousand columns of newspaper publicity in the Second Federal Reserve District alone between May 10 and June 18. This estimate is conservative. During the last days of the loan, many papers, particularly in the Metropolitan District, ran each day from three columns to a full page on the Liberty Loan. Our press clipping bureau sent us more than 58,000 clippings, weighing over 170 pounds. I believe this count represents hardly one-quarter of the actual number of Liberty Loan stories.

"The press room sent out 377 newspaper stories of sufficient length to be numbered. We did not number stories of one paragraph. Several of the Liberty Loan stories were over twenty typewritten pages in length and on some of the heaviest days we prepared over fifty pages amounting to fifteen columns of material. Our work included two special stories each day for the United Press, one special story each day for the Associated Press, a special story for the American Press Association three times a week to be used in their

plate service, and a special rapid-fire service to the tickers.

"We had sixty-five photographs taken during the campaign. Every one of them, with the exception of a single photograph, was used in one or more newspapers. Some of them did not appear in New York newspapers. Few of them appeared in more than one New York newspaper but in almost every instance they were used widely throughout the entire United States. Many of them were sent out by services such as the Scripps-McRae News Service, the American Press Association or the Associated Newspapers."

News Features—The news force in cooperation with volunteers from the banking community, were able to develop a great many items of interest which the papers considered worth while putting on their front pages. These included, for example, a flight over New York of seventeen aeroplanes dropping Liberty Loan literature. There were notable subscriptions to the Liberty Loan by professional baseball teams, statesmen, prize fighters, soldiers, opera stars, sailors, babies, millionaires and citizens of foreign birth. When these subscriptions were signed they were made the subject of photographs which were largely used in New York, and still more widely throughout the United States. Our pictures of Chinamen subscribing to the loan, babies subscribing, sailors subscribing, and the farmer signing the subscription blank while standing in his furrow beside his plow and horses, were published in practically every section of the United States. Other front page stories included a meeting arranged in honor of the Secretary of the Treasury, a statement from President Wilson, a cable from Marshal Joffre, letters from Colonel Roosevelt, Mr. Taft, etc. It should be added that this bureau supplied to the papers each day at least twice as much material as they could use in fairness to those of their readers who retained an interest in the war news and other current events. One of the most effective pieces of work was

done by Parke F. Hanley, of "The Sun," who made an extensive tour of New York State, personally explaining to local editors and Liberty Loan committees the plans laid out by the general committee.

Every Form of Display—The newspapers became more and more friendly to our undertaking and gave us every form of display known to the newspaper world, including news, editorials, hundreds of cartoons, special announcements in boxes in various portions of the paper, line announcements at the bottom or top of various pages, treatment in the general news columns, on the sporting page, women's page, and financial page and in other columns. Some of the leading metropolitan papers ran more than sixty consecutive news stories more than one column in length. This is probably a record in newspaper history.

Particular mention should be made of the financial dailies, weeklies and monthlies which have devoted themselves to educating the public on this loan in a most consistent and intelligent way. Their pages have been filled with Liberty Loan material and many editorials have appeared which have naturally been of a very penetrating character, as their editors are trained writers familiar with financial implications. Many farm papers also gave excellent space to the loan.

Resolution Thanking Papers—The following resolution was adopted by the general committee at the close of the campaign:

"The Liberty Loan committee desires to go on record to the effect that no other factor has contributed in greater measure to the success of the Liberty Loan in the Second Federal Reserve District, than the intelligent and consistent coöperation of the newspapers of this district. Their splendid assistance was an indispensable contribution to the work of the committee."

2. THEATRICAL ORGANIZATIONS

Theatrical organizations were handled by Brooks Leavitt, of Bertron,

Griscom & Co., who enlisted the active help of Daniel Frohman. Mr. Frohman called the most prominent actors who were then in this section of the country to his studio and obtained their coöperation. As a result of this we were able to have speakers in the principal theatres of the district every night during the last two weeks of the campaign. Mr. Erlanger had a full page advertisement put in every theatre program in the United States, booths were placed in the lobbies of many theatres, and posters on many of the theatrical billboards. In addition to this, prominent managers and actors subscribed generously, allowing us to take their pictures while so doing, and many others gave out interviews which were interesting to a wide public, and acted as salesmen and saleswomen in department stores.

Mr. Leavitt in his report says: "The one thing that I would emphasize in framing recommendations for future work is that time be given for thorough organization along the lines which have proved most productive in the work just closed. With such organization I believe much greater results will be attained and much waste in effort and material saved."

3. MOVING PICTURES

Lee Olwell, of the National City Company, was able to arrange a meeting in our offices of the principal moving picture industries in the United States. A committee was formed under the leadership of Wm. A. Brady, president of the association, which turns out probably ninety-five per cent. of all the moving pictures in the country, and, in coöperation with the director of publicity of the Liberty Loan in Washington, a national coöperation was arranged which placed a loan appeal on practically all the films that were released in the United States during the last two weeks of the campaign, reaching many millions of people. A gift of 500,000 feet of film for this purpose was obtained by Mr. Olwell from the Eastman Kodak Company of Rochester.

4. SPEAKERS' BUREAU

Harold G. Aron, a lawyer practicing in New York who had charge of the speakers' bureau in the Hughes Alliance, gave practically his full time to organizing a speakers bureau under the publicity committee. This was under the general supervision of W. S. Kies and was finally brought to a very high state of efficiency. The detail involved in the speakers' bureau was very great, and it was subjected to considerable criticism in the early days of the campaign because when asked for prominent speakers on a few hours' notice it was often unable to supply them. Toward the end of the campaign these difficulties were eliminated and Mr. Aron and his assistants were able to supply speakers for approximately 1,000 meetings, large and small, in various parts of this Federal Reserve District.

CO-OPERATION WITH OTHER DISTRICTS

To coördinate the work of our own committee with that of Washington and the committees in other districts a special office was established under the direction of R. G. Page and P. A. Buttrick of the Bankers Trust Company, who sent out exhaustive reports at the close of business each day, accompanied by copies of our literature as published.

THE WHOLE DISTRICT VOLUNTEERED

In addition to these four sub-committees, mentioned somewhat fully by way of illustration, there were scores of others which played an important part in bringing the Liberty Loan to the attention of the millions of men, women and children of this district. It should be noted, of course, that all these organizations are mentioned in connection with their publicity work only. It will be understood that many individuals did a tremendous amount of work for the distribution committee, the bond issue committee, and others which is not noted in this summary.

BANKS AND BOND HOUSES

Of course it goes without saying that without the coöperation of the banks,

trust companies and investment houses the success of the loan would have been impossible. Distributors of the loan received no compensation for their services. In addition to this practically the entire working forces on the loan, in the Second District numbering thousands of men, were supplied without cost to the Government by the banks and bond houses. Some of the banks lent without charge senior and junior officers. An indefinite number of partners of bond houses gave practically full time. The clerical work necessary for taking subscriptions and distributing the loan on the part of the banks was very extensive and ran into a total cost amounting to hundreds of thousands of dollars. Most banks and bond houses sent out from three to ten different sets of circular letters to their customers all over the United States and practically all the officers and employees of the banks were constantly at the service not only of their customers but also of the public in general in giving information on the loan and in helping to place it.

Mayor Mitchel and the various municipal organizations coöperated in many ways, including almost unanimous subscriptions to Liberty Bonds. The mayor, with characteristic patriotism and energy, responded to all our many calls upon him.

The mayor's committee on national defense coöperated fully with the speakers' bureau and in distributing posters. The women's committee, under the direction of Miss V. Furman of the Columbia Trust Company, and Miss M. M. Bruere of the National City Bank, who worked tirelessly throughout the entire campaign, supplied many speakers, distributed posters, issued a great amount of literature and undoubtedly exerted a powerful effect on the final result.

The insurance committee distributed a large amount of literature, held a successful rally in the Century Theatre and put thousands of agents in the field. William T. Atkinson, president of the Life Underwriters' Association of New York, reports that subscriptions obtained through the agents of one company alone totaled \$9,549,650. The

Boy Scouts, under the direction of J. E. West, distributed all over the country 8,000,000 pieces of literature specially printed for them and report collections of subscriptions amounting to over \$18,000,000. The Chamber of Commerce of the State of New York, the Merchants Association, the women's committee, the Masonic order, Billy Sunday's tabernacle, and many other organizations distributed a total of 2,500,000 small "How? What? Why? When? Where?" folders to their membership to be inserted in outgoing mail during the last two weeks of the campaign.

The American Bankers Association sent out their own speakers and prepared large quantities of literature which they supplied to us in generous amounts. The Liberty Loan committee of the New York Stock Exchange advertised the loan in hundreds of newspapers throughout the United States. The Retail Merchants Association included Liberty Loan cards in their regular advertising. The A. B. A. undertook, however, to carry on its very effective work almost entirely outside of this Federal Reserve District.

The Vigilantes, a patriotic association of authors and artists, under the direction of Hermann Hagedorn, including such men as George Ade, Irvin S. Cobb, James Montgomery Flagg, Charles Dana Gibson, Rex Beach, Ellis Parker Butler, Julian Street, Hy. Mayer, Booth Tarkington and others, supplied special articles on the loan which were forwarded in plate form to thousands of papers. In another campaign even more people would be reached if all this material could be released in advance through the Liberty Loan committee.

SCHOOLS

Through the active coöperation of the school authorities in New York, literature on the Liberty Loan was distributed to 800,000 school children. A poem by Edward Everett Hale entitled "Take the Loan" was handed to each child and teachers were instructed to outline what the bonds involved. This

work can be very much extended in another loan if time for preparation is available.

The coöperation of societies such as the Elks and the Masons was extremely valuable. Many clubs such as the Friars and the Lambs helped in various ways to obtain publicity. The Society of Illustrators was ready on call to supply pictures, cartoons, poster designs, etc., in a really remarkable manner. They are already at work on designs for the next loan. Many colleges formed committees of their alumnae or alumni for speaking and other purposes. One Harvard class circularized its members individually and obtained hundreds of thousands of dollars worth of subscriptions to the loan through this source. The Hotel Association of New York City coöperated by putting posters and circulars in their lobbies and by furnishing rooms for meetings.

INDIVIDUALS

H. Martin De Long, of Frederic Hatch & Co., had a Liberty Loan poster stamp prepared which he sold at cost to local firms to the number of 800,000. He maintained a separate account and a surplus of \$500 was left over, which was donated to the Red Cross. B. E. Tousley, secretary of the New York branch of the League to Enforce Peace, arranged, through the War Department, to have seventeen aeroplanes released from the training school at Mineola to fly over Manhattan and drop Liberty Loan circulars. W. M. Sawyer, of the National City Bank, helped materially with the organization of several committees and special meetings. Very valuable work was done by Walter E. Sachs of Goldman, Sachs & Co., in obtaining the coöperation of the organizations on the East Side of New York. In this way many thrifty small investors were reached who could hardly have been reached in any other way. Charles T. Gwynne, secretary of the Chamber of Commerce of the State of New York, gave a great deal of his valuable time to advising us on vital matters.

Through circularizing his membership he was able to dispose of hundreds of thousands of our leaflets. For example, he reached the Pennsylvania Railroad in time for them to enclose 65,000 folders in the same envelope with their dividend checks. John Duffy of the Lehigh Valley Railroad prepared a campaign text book, amounting to 52 closely printed pages, in consultation with the Treasury Department in Washington, material being supplied by us. Mr. Manny Strauss gave practically full time during the campaign and was of great value to the committee in suggesting methods of systematizing the entire publicity work. H. F. Rawl, of the Christmas Club, supplied considerable literature and gave effective help in publicity work among small investors.

Dr. Walter Laidlaw, executive secretary of the New York Federation of Churches, worked indefatigably during the entire campaign. He prepared for this committee, and through a trip to Washington finally had adopted for national use, an outline for a sermon to be used in all churches of the United States on a special day. This was printed and distributed to every clergyman in the country. He also arranged to have the churches in this district toll their bells on evenings during the last days of the campaign. John Muir issued a very large amount of literature in connection with the partial payment plans, and was instrumental in getting a considerable amount of advertising on this subject. Fred B. Dalzell, Jr., arranged with tug boat owners to have boat whistles blow at stated times.

THOUSANDS OF WORKERS

It would be impossible without expanding this report beyond reasonable limits to give personal mention of all who helped. It should be understood, however, that literally thousands of people offered their services and were brought into action as fully as the limited time and resources would permit. It was a truly remarkable illustration of the American spirit of "team work" developed under trying circumstances. Our committee has estimated that the

total sum contributed to publicity in this district, including gifts of advertising space, activities of scores of organizations, circulars and literature distributed by banks and brokerage houses, etc., amounted, including publicity activities alone, to at least \$750,000.

ADVERTISING

In our advertising we had the generous coöperation of the Associated Advertising Clubs of the World, through a special committee made up of Collin Armstrong, Geo. W. Hopkins, O. C. Harn and Lee Olwell, and of a number of other firms and individuals expert in advertising. One representative of the Associated Advertising Clubs of the World was designated to work in our office. When he found it no longer possible to continue this assignment various substitutes were supplied, who did tireless and telling work in various ways.

In future, I believe that the proper arrangement would be for the Liberty Loan committee to have its own advertising specialist, just as we had one man to coöperate with newspapers, one to coöperate with actors, etc. If the Associated Advertising Clubs of the World could again designate a man to coöperate with our representative we could thus get the fullest value out of the services of that remarkably effective organization.

In New York and Brooklyn alone, more than 1,348 columns of advertising were obtained through our combined efforts, totaling approximately 167 pages, without any charge to the Liberty Loan committee. The total obtained by the next highest city is estimated at approximately forty pages. This result reflects a great deal of credit on the generosity of local advertisers, when consideration is given to the very high cost of advertising in New York, where the rates are considerably higher than in any other city in the United States.

Particular credit is due to the efforts in this connection of Collin Armstrong, president of Collin Armstrong, Inc. Barron G. Collier supplied many thousands of dollars' worth

of street car cards without charge and placed his extensive establishment at the disposal of the committee. B. F. Pope, as chairman of a committee formed for the purpose, was able to obtain the coöperation of financial advertisers in this city so that a full column advertisement on the loan appeared on the financial page of practically every paper during the last ten days of the campaign. In this work he had the coöperation of M. De W. Hanrahan, of A. H. Bickmore & Co.; E. T. Tomlinson, of Doremus & Morse; Ewan Justice, and about twenty other men.

ADVERTISING IS A COMMODITY

A very pertinent question has arisen with regard to paid advertising. We took the stand in the last campaign that we should not ask the newspapers to contribute free advertising space. The fundamental principle seems absolutely clear, that advertising is a commodity and that the Government should pay newspapers to carry Government advertising just as it pays railroads to carry Government freight. W. T. Mulally in his report says: "We firmly believe that all work should be paid for—advertising space, copy writing, designing, etc." Collin Armstrong in his report says: "The selling or distribution of United States bonds, even for so lofty and imperative a purpose as that of the present issue, is a matter of business as well as of patriotism, self-protection and reëstablishment of civilization. So far as we know, no one profited by the last flotation. All personal services were contributed by principals and whatever compensation subordinates received came from their regular employers who contributed most liberally to the selling and clerical forces.

"The question is pertinent, can a duplication of all this gratuitous service and material be relied upon in conducting the next campaign? Is it logical or just to ask bankers, advertising interests and all others who contributed to the success of the last loan to bear a larger share of the burden than their

fellow citizens who share or will share equally in the beneficent results of victory? In our judgment the 'Sinews of War' are as essential in a financial campaign as on the battle-field. The Government should provide the first as well as the last mentioned. Not necessarily at a profit, but at a fair compensation to those who render service or deliver the goods. Only in this way, it seems to us, can a comprehensive campaign be laid out and successfully conducted.

FARMERS SHOULD BE REACHED

"In the last campaign no one knew from day to day what space or publicity could be commanded or relied upon in furtherance of the work; and it is a matter of common knowledge that important and reasonably fertile fields were not cultivated because of inability to reach them. The farming population is a conspicuous instance. The experience of Great Britain in floating her war loans should serve as a conclusive argument in favor of a definite and adequate appropriation to effect the sale of the next issue. If the present appropriation, or what remains of it, is not adequate for the purpose as determined by qualified experts, Congress should be urged to provide the necessary funds."

This committee agrees entirely with the principle involved. We have not arrived at a point yet, however, where we can put forth a specific recommendation that we believe would be practical in actual operation.

This appears to be a matter to be decided by the Government. It is certainly most important. It is a question clear in principle but difficult in practice.

POSTERS

Obviously posters are one of the cheapest and most effective mediums for attracting wide attention to a popular Government loan. During the last campaign the standard poster with a design of Liberty aroused considerable comment. It should be said that the bureau in charge of this work in Washington was under enormous pressure

from all twelve districts at once and turned out a favorable average of material in a very short time. In another campaign, however, it is suggested that the local committees be given an opportunity to appoint advisory representatives to pass on the art productions for the actual placing of which before the public they are responsible.

Nearly 1,000,000 posters were distributed. A blue poster, designed by a member of the Society of Illustrators, was in particular demand, both in this district and outside. All posters received were distributed with the exception of approximately 80,000 which arrived from Washington two days before the close of the campaign, obviously too late to be distributed with any degree of effectiveness. We have a nucleus on hand, however, which will be of value at the outset of the next campaign.

A simple poster, entitled "All About Liberty Bonds," which explained the details in straightforward language, was distributed widely over the district. This poster was also translated, through the coöperation of the Association of Foreign Language Newspapers which rendered invaluable service throughout the campaign, into the following languages and printed at widely separated establishments wherever the proper type could be found:

French, Italian, German, Polish, Chinese, Norwegian, Bohemian, Swedish, Russian, Finnish, Hungarian, Slovak, Serbian, Yiddish, Lithuanian.

The posters in each of these languages were in large demand. The heaviest demand, however, outside of English was for those in Jewish, Italian, German and Chinese.

DISTRIBUTION AND PUBLICITY

The committee worked very closely with the Liberty Loan distribution committee which was under the inspiring leadership of Allen B. Forbes. The sacrifices made by the bond men on that committee and by the many others who coöperated in their remarkable work, made the task of the publicity committee much easier in many respects. In another loan, however, it is suggested

that the distribution committee designate one man who can give his whole time to this work, establish headquarters adjoining those of the publicity committee, and thus keep the publicity committee advised of the important activities of the distribution committee, and relieve its chairman of the endless calls in matters of detail which it was necessary to make upon him.

In many cases our work would have been facilitated if it had been possible to have a man definitely thinking about publicity on each of the large distribution sub-committees. In a campaign of this kind the work of each committee is essentially, in our opinion, a one man job. No matter how good a committee may be, the work cannot be carried on in an efficient and rapid-fire manner unless one man is definitely in charge, not only to give general attention to the details of the work, but also to handle the inevitable complaints which arise daily in great numbers. The policy must be to let everybody go away happy no matter how captious his wants may be, and this cannot be accomplished if the dissatisfied person is passed from desk to desk until he gives up his effort to locate the "guilty party" and leaves the office a Liberty Loan knocker instead of a booster.

The publicity committee feels particularly indebted, not only to Mr. Forbes, but also to C. E. Mitchell, E. B. Sweezy and others on the distribution committee for generous coöperation. The suggestions made above are not in the least intended to criticize a committee the results of whose work speak so eloquently for its effectiveness. The suggestion of a single executive manager of the committee is offered merely with a view to making easier in another loan the coördination of the work of two committees whose work is often almost identical and must at all times be in closest contact.

Owing to the early establishment of the publicity committee in the Equitable building offices it was necessary to maintain there a general information bureau which was obliged to answer a wide variety of questions on the part of sev-

eral hundred persons daily. Many of the committees did not realize this, and in the mind of everyone the idea of results necessarily preceded that of system. The point is simply raised here in order that a more complete coördination may be worked out before the next loan is launched.

ACKNOWLEDGMENTS

It has been impossible to mention here the large number of people who gave their time intelligently and generously to the Government through the Liberty Loan publicity committee. The amount of intelligent service which was offered and accepted was little short of amazing. An attempt has been made to reach every worker with personal letters from the Governor of the Federal Reserve Bank, the director of publicity in Washington, and the chairman or secretary of this committee.

THE NEXT LOAN

Looking into the future it is suggested that the time to prepare for the next loan is now. Many of the weekly and monthly magazines which will appear during the course of the next loan are now being made up. Articles must be supplied to them immediately if they are to appear when needed.

The newspapers will be very glad to take from time to time during the next two months interviews with prominent men regarding the results of the first loan and carrying constructive suggestions with regard to the next loan.

Some of the men who worked so effectively during the last campaign have already been approached and have indicated their willingness to undertake the same work next time, provided they have reasonable notice in order that the various interests which are asked to do work involving considerable sacrifice to them may have a reasonable time to prepare. This course is highly advisable not only because it produces better results, but also because it makes it possible for the various interests who desire to coöperate to mobilize their resources more fully and to render the

Government a fuller measure of assistance without almost impossible sacrifices to the parties involved.

It may be added that many of the men who worked in the last loan, if they are not immediately enlisted for this work, will go off to officers' camps or other services and thus be unavailable in September or October when their help will be badly needed here.

SUGGESTIONS

One or two specific suggestions taken from reports submitted should be recorded here.

R. R. McElvare, of the National Bank of Commerce, who acted as our expert in information on Government finance, says: "It seems advantageous to have some sort of clearing-house to serve as an information bureau. It should have available all information about organization and in addition might serve as a means of obtaining for the publicity committee information as to exactly what other committees were doing. Such an institution might go far to keep all the various committees coördinated, and to avoid confusion.

"It is to be hoped that the vast facilities of the post office will be used in the next loan to reach the uninitiated in the city and the entire rural section of the country. In the schools is to be found another agency that will reach many persons who can be reached effectively in no other way. Both these agencies have been used to advantage in the loans of other countries."

ANNOUNCING FIGURES

It will be remembered that in the early stages of the loan there was some difference of opinion as to the giving out of subscriptions. The general committee took a stand in this matter and it will be recalled that subscriptions throughout the country jumped very largely after the full facts were known. We believe that the totals should be given out earlier next time. In this connection A. Leonard Smith, Jr., of the New York "Times," says in his report: "I think there might have been

more frankness in regard to figures of the loan. I realize that this matter is not in the scope of the publicity work, but I would discuss it from a newspaper reporter's point of view. What was to be avoided, enthusiastic estimates of over-subscription to the loan, was just what happened, and it happened for this reason. Newspaper men are bound to get estimates on a story like the flotation of a big loan, just exactly as they are bound to get 'dope' on an election. If a responsible source refuses to give them any inkling of the true state of affairs, they are mighty likely to get estimates for themselves, estimates which are chosen with an eye for news value—exaggerated for good or bad."

In conclusion, Mr. Kies of our committee says in his report: "As I review the work * * * the only criticism that can be made is the criticism which has always been made of any organization hastily thrown together. In the future this can be remedied by starting the work well ahead of time, by outlining in greater detail the various phases of the work, and by selecting with greater care the men who are to be entrusted with the carrying out of the details, and in this way relieving the members of the main publicity committee of a tremendous amount of work. The publicity committee itself should be able to devote most of its time to the campaign in its broader aspects.

"I think there exists the nucleus of a very excellent organization. There should be added to this a number of men to carry out specific pieces of work, as suggested, and if a start can be made a month or so before the next campaign begins, the work of the next bond issue can be carried out with a very small part of the strain which was attendant upon the work just finished, and with much less friction between the various working committees."

RECOMMENDATION

Literally hundreds of suggestions have come to the committee from New York and from other parts of the coun-

try covering the most effective procedure on the next loan. Many of these are obviously sound. Others must be worked out. It would be impossible to discuss them all here. If an office could be opened and a small effective staff employed at once these matters could be carefully studied with a view to their most careful and satisfactory application. The committee also has a few ideas of its own, some of which it was impracticable to carry into effect during the last campaign.

We would definitely recommend, therefore, that publicity headquarters be opened immediately and half a dozen competent people employed to form a nucleus for the larger committee which can be gradually developed until shortly previous to the actual opening of the next campaign, when the entire machinery can be in complete coordination and ready to start off efficiently.

It is very important that quarters be taken in some central place where expansion is possible. The congested quarters recently vacated subjected the entire work to an atmosphere of confusion which ought to be largely avoided. It should be added, however, that any publicity headquarters will inevitably carry with it a certain rush and bustle wholly foreign to a banking atmosphere.

Every day now is valuable. There are a great many people who are willing immediately to give their time gratuitously to the work of the committee, and I would suggest that no time be lost in forming headquarters as a rallying point for this activity.

APPRECIATION

It was a pleasure to all of us to have had the rare opportunity to take part in this great work which has been brought to so successful a conclusion. It is desired to take this opportunity to express our appreciation of the generous manner in which the general committee, its secretary, its assistant secretary and its executive manager relied upon our judgment and thus made it possible and easy for us to work in the most rapid and efficient way possible.

Improving the Earnings of Country Banks*

By GEORGE L. TICKNER, Secretary National Bank of Syracuse,
Syracuse, N. Y.

AS bank salaries, officers' together with the expense item called rent, furnish a bank with the bulk of its expenses, it probably is fair and equitable, at the moment, since we are attending a convention of bank officers, that we spend a few moments in considering, since what we draw furnishes a large amount of the outgo, how we might through improved methods increase the income.

I think we will not discuss the vice or virtue of four per cent. on individual deposits—more particularly as another committee, I am this morning informed, is to take that up for more elaborate discussion than the time allotted us affords—nor do I think we had better consider as to whether the Federal Reserve has reduced the earnings from exchange—I think country bankers at least will concede that.

TO EARN MORE MONEY

It is rather my notion to take up three definite propositions toward increasing the earnings of up-state (country) banks, and to go at them in a simple way, so that when we get through with this meeting we will have concluded to do something definite.

I intend to claim that the average bank does not watch its unproductive moving assets and that they amount to from ten to thirteen per cent. of their deposits, and that if they can be reduced, a great saving can be made.

I intend to claim that many up-state banks are overcapitalized, and by "capitalized" I mean capital, surplus and undivided profits—and I have something over a page of New York State country

banks listed from the May 1 statements to illustrate the proposition. (Of course, no names are to be given.)

I would also like to take a few moments to discuss a topic which is not new, but which is most pertinent at this time—the matter of making some reasonable charge for the service in handling small balance, profitless checking accounts.

Let us proceed to the first proposition:

UNPRODUCTIVE ASSETS

(First Source of Profit)

In the nature of banking, a certain amount of moving, quick assets must always be unproductive, such as

- Cash on hand.
- Nationals, nickels and cents.
- Cash items.
- Exchanges.
- Interest receivable.
- Redemption fund.
- Deposits—Federal Reserve Bank.
- Possibly other items.

If a bank does not take off a daily analytical statement, figuring out how much the unproductive quick assets amount to each day, and considering daily whether some items could be reduced, I am persuaded to believe that this item is bound to run at least a little larger than it should.

Our notion at the National Bank of Syracuse is to take this item off daily with the statement and try to keep it as low as we can in proportion to the deposits, knowing that as the deposits

*Address delivered before National Bank Section, New York State Bankers' Association, Lake Placid Club, New York, June 21, 1917.

increase this item will increase, but also knowing that as the deposits decrease this item should decrease, and it is not always so, as even though watching the item we sometimes find as the deposits decrease a bit this item goes up, through the cash collections in the mail, need for an increased volume of currency on hand, and otherwise.

The point I raise is simply that if you figure daily how much your controllable unproductive moving assets are, you certainly have some chance of keeping them at a minimum, and that if you do not figure them, I don't just see how you are going to closely control them.

Suppose we say if the bank does not know what its discounts or loans are daily, and the amount of cash, bank's and all, on hand daily, an officer is not in the best position to decide how much money he should seek to have paid.

REDUCE CAPITALIZATION

(Second Source of Profit)

A second source of increased profit for some up-state banks, to my mind, would be to reduce their capitalization, and by a bank's capital I mean its whole investment—surplus and undivided profits included.

Looking at it from a practical standpoint, capital is a certain amount of money that the owners of the business put up to operate the bank on, and this amount of money is really the safety fund between depositors and loss. It ought to be enough to secure depositors, but how much more is a matter of opinion for stockholders to decide. If they are satisfied—no reason to change.

It surely is not necessary to go into the banking business to lend capital. The trick of banking, as I see it, is to get deposits and to persuade others that you can handle their money better than they can, and I think this statement, while somewhat flippant, has a good deal of truth in it, since the bulk of the increase of up-state banks nowadays comes not in the active but in the interest department of the business.

Inactive accounts, generally speaking, in up-state banks are really invest-

ments—most of them are permanent—few are temporary accounts. Banks put it out temporarily and otherwise, and so would the depositor, if he could handle it as well as the bank.

AS THE PROPORTION OF DEPOSITS TO INVESTMENT INCREASES THE BANK MAKES MORE MONEY

It is no secret that as the proportion of deposits to investment increases the bank makes more money. It is my notion that a bank should very seriously consider as to whether it has too much invested for the amount of deposits it is carrying. I am not unaware that to make certain sized loans requires a certain capital. But as to whether in order to have enough capital to take care of a few large borrowers for a portion of a year, it is a good plan to carry an abnormal investment all the year, is a matter for a difference of opinion.

SERVICE CHARGE

(Third Source of Profit)

There is nothing new in my suggesting that banks in all communities should get together and make some uniform arrangement to charge small active accounts a service charge. In Syracuse the matter has been discussed at different times, but we do not seem to be able to get together. Like in other cities that I have visited, the suggestion comes up that you will offend the account, that it is connected with other good accounts, that it will grow, that you will drive it to the other bank—but my notion is that all banks in a community should be able to get together on a uniform agreement, using a uniform charge slip which sets forth that all banks are charging the same price for the same service. Have the names of all the banks on the charge slip with the resolution adopted by them. Put the charge slip through the ledgers once a month. Have the bookkeeper go through the ledgers to make the charge.

Quite a number of banks do this now, but I have discussed the matter with banks in New York, in Chicago and in Cleveland, and I do not find (while it is

done here and there), that there is any coöperative agreement among the banks to handle these accounts in the same manner.

Nowadays banks carry thousands of profitless accounts—accounts on a balance of \$100 to \$200, which have twelve to fifteen entries a month and some fifty. To my mind it does not need an adequate cost system to figure whether you are making or losing, and the difficulty is not in devising some system that will figure out the loss. The problem presented is as to whether the banks think they might just as well make these accounts pay them something. In the larger cities where I have discussed the problem with banks they are practically agreed in telling me that they prefer the account closed.

My own notion is that the banking business up-state, with its Christmas Clubs, Thrift Clubs, etc., is getting to be a department store, and that we should not incline to the view that only those people who are able to carry a compensating balance should be permitted to operate a checking account. The matter of being able to draw checks on a bank and have them paid and returned is a great convenience, and I think that this service should be extended to anybody who has anything to deposit. I believe that clerks and employees working on moderate wages should not only be given the privilege of depositing and checking out, but should be encouraged so to do, but I also think they should pay for the service the same as they pay for anything else. Street cars do not carry them at a loss now on the theory that later their patronage will be more valuable. Nor do they buy merchandise from the seller to the latter's loss on the theory that later their patronage shall become profitable.

To re-state the matter briefly, where an account averages \$100 to \$200 balance, I think banks should get together in these smaller cities and centers and agree that accounts drawing six to ten checks, or having a dozen entries a month, should pay a moderate charge of 50 cents or \$1 a month. I honestly believe that some banks could make as

much money out of this service charge as they make in lending their deposits.

Absolutely I disagree with the notion that small accounts should be discouraged or that banks should take a disinterested view as to how these accounts are handled.

FEDERAL RESERVE REDISCOUNTING

It is my notion that banks will gradually have a more favorable attitude about rediscounting at the Federal Reserve Bank and will begin to find it is a part of their business to re-borrow at certain seasons to serve their customers and that a bank might be able to increase its earnings by keeping loaned up, knowing that there is a certain sense of safety in the ability to rediscount at the Federal Reserve Bank.

FEDERAL RESERVE DEPOSITS NOT A LOSS

In the matter of reserves under the new law, I agree with the proposition that we are just as well off as under the old. Under the old we carried fifteen per cent. reserve, six per cent. of which was idle in our vaults and nine per cent. loaned to reserve banks at two per cent. Under the new law twelve per cent. is idle and the balance, three per cent., can be loaned at the going rate in straight loans. The going rate is six per cent. We must agree that six per cent. on this surplus three per cent., which we are not now required to carry, equals eighteen per cent.—offsetting what we obtained under the old law in lending nine per cent. of our reserve to our reserve depositaries at two per cent. Two times nine is the same thing as six times three.

As a matter of fact, under the Federal Reserve Act, it's the only law under which a bank can operate on the minimum reserve of twelve per cent. Under the old law, all banks had to keep a few extra per cent. on hand to have some extra cash to do business with, for counter purposes, and something in reserve.

FEDERAL RESERVE ACT HAS SAVED US FROM PANIC

We want to consider right here that raw material is being bought at largely

inflated prices; that the goods manufactured are being sold at inflated prices; that we are in greatly disturbed times; that we are passing through the need of furnishing seven billions of dollars for our own needs and those of the allies; that we are going into war fast and may need twenty billions—may need more.

I do not know how, on the 28th of this month, it would have been possible to finance the two billion Liberty Loan without the aid of the rediscount privilege at the Federal Reserve Bank, and, when we take it all in all, I think we will all concede, considering the times, that the facility and the strength and the coöperation of the Federal Reserve to the great needs of the present time has saved the situation and, in other words, saved us from a great panic, and I want to go on record here and now as so stating.

SUMMARY

To restate briefly three ways to help build up profits:

1. Watch the unproductive moving assets. Keep them at a minimum.
2. Consider whether you are carrying too much investment for the amount of business and as to whether it would not be wise to reduce your investment and put it in better relation to your deposits. For a bank which is new or rapidly growing, we cannot consider reducing the capital, but where a bank is old and has about all the business it is going to get in that community, to my mind

it should not have more than one-sixth investment to going business.

I think the average banker will concede that a commercial business which has enough capital to carry it through both its maximum borrowing needs and minimum needs is overcapitalized. To state the matter in another way, the commercial business that does not at some season of the year borrow money must necessarily have some of its capital inactively employed during its minimum season.

3. It would seem practical for banks up-state in many sections to get together on an agreement to make a uniform moderate service charge on small balance, active checking accounts—the charge to be within reason and such that the customer will stand it. If you act alike, you will get the charge and increase your profits. If you act separately, I doubt that you will get any farther than we are this morning.

A BANK SHOULD EARN FIVE PER CENT. ON
INVESTMENT AND ONE PER CENT.
ON DEPOSITS

Roughly, a bank should earn five per cent. on its own investment and, say, about one per cent. on its deposits. In doing this, it probably is doing all that should be expected—at least up-state, where in many communities we are against the four per cent. rate on inactive accounts. I am not suggesting that where a large element of deposits is without interest a bank should not earn and does not earn more than one per cent. on its deposits.





TALKS ON BUSINESS BUILDING

By W.R. MOREHOUSE

The Advertising Possibilities of Pay Envelopes

AT no time in our history have the employers of large numbers of men used pay envelopes to facilitate the disbursement of wages as they do to-day. Pay envelopes are a great convenience, in fact, almost a necessary adjunct in the handling of pay-rolls. They have become universally popular, and as a consequence are in great demand.

Unless these employers can secure pay envelopes from banks free, it is apparent that they must go into the market and buy them. To save this expense, they will gladly use envelopes given them, although they serve to advertise our banks. In accepting pay envelopes free, these employers are not accepting charity in any sense of that term, but extending a favor to banks, which in the end will be benefited by the transaction.

GOOD-WILL OF EMPLOYERS

The free distribution of pay envelopes secures for the bank distributing them the good-will of employers, which is a friendship to be coveted. Too often this good-will has been under-valued, with the result that not all banks have done much to secure it. As a matter of fact, a bank must have the good-will of employers of men and women, before it can effectively conduct a campaign for the business of their employees. The bank that secures the unqualified endorsement of an employer

will have no difficulty in securing the good-will of his employees also, and in many instances, will secure accounts that it could not otherwise obtain. The fact that an employer uses pay envelopes advertising a certain bank, is in itself conclusive evidence that he approves of the bank enough to permit it to advertise itself to his employees.

There are many other reasons why pay envelopes are worth while as an advertising medium. Owing to the use made of them, a way is opened up whereby a bank can do definite work, individually and collectively among wage earners. Through pay envelopes, employees are made familiar with the bank.

Regularly, week after week, month in and month out, the name of one bank in particular is persistently given attention. The message these envelopes give does not fail to impress the employees with the importance of saving money. Many of them are probably already convinced that they should open a bank account and save, but have been waiting for a more convenient time.

Pay envelopes are a form of advertising that not only reaches the skilled workman, the master mechanic, but also the ordinary laborer on the pay-roll. They constitute one of the very few forms of bank advertising which kept the attention of that class of wage earners who possess but a meager education. In this same connection it is

significant that the immigration committee of the United States Chamber of Commerce should recently have adopted pay envelopes as providing the best medium for reaching ignorant workers.

Of course, there are banks that have used pay envelopes without receiving in return business commensurate with the expense, just as there are banks which have made a failure of other forms of advertising. Pay envelopes, like other advertising mediums, need to be energetically supported, and they need to have the right kind of a "punch" incorporated into their very fibre. This is true of any medium that is expected to produce good results.

It is a great mistake for our bankers to assume that because pay envelopes can be bought for 75 cents a thousand, no importance attaches to their use. The very fact that so many can be bought for so small a sum is a point in favor of this kind of advertising, for the price in this particular case is the smallest consideration. Since they are inexpensive, banks should use them liberally among all wage earners in their territory to deliver a message to every man and woman who has a regular income, and for this reason is a good candidate for a savings account.

Almost every failure in the use of pay envelopes by banks, if analyzed, would reveal the fact that the failure was entirely due to a lack of interest on the part of the bank, and to an indiscriminate distribution of the envelopes.

In the first place, banks need not expect large results as long as they continue to use the little tag envelope that has been universally used for years. It is as common a piece of merchandise in the hands of the average workman as a paper bag, and stands for just so much paper and nothing more. To say the least, it is unattractive, which may be due to some degree to the fact that one size, same color, same style, and the one black print have been used without variation ever since pay envelopes came into being. The message, too, has usually been so badly

smear'd up, due to heavy black type and too much print, that it is barely legible. Unless there are variety, originality, style and color in the envelope the average wage earner will not be interested in what a bank has to say to him. Bankers need to have the right perspective. They should consider the wage earner just as human as they are, a man of likes and dislikes, a man who likes attractive things, things that are brand-new and original, that possess color; a man who likes any new thing just for a change from the monotony of every-day living. They, too, like to read a message that is fresh, if not altogether new—the same story told in a different way.

In fairness to this medium, let our banks get behind it, at least to the extent of giving pay envelopes a fair trial. When you place the next order, stipulate that these little envelopes be made up in different colors, some blue, others white, red, orange, yellow, green.

As to the bank's message to wage earners, let it be to the point, and as personal as possible. A word of encouragement to the man who wants to get ahead will help, for all men want to advance. If possible, make the envelope so different from the one that has been used for twenty years without a variation, that the recipient will be startled by the change. This calls for originality. You might print your message on the inside of the envelope, or better yet, if not too expensive, have a little slip containing a special message inside the envelope. You will find that because you give out something "different," it secures attention.

Upon delivering pay envelopes to employers, request that one color be used one pay-day and an envelope of another color the next pay-day, and so on. This little innovation, from the usual practice, will get you additional attention.

COST

It has been estimated that it is costing our banks approximately \$6 for every new account opened. If this estimate is reasonably correct then for

the price banks are now paying for one new account, a bank can purchase and distribute nearly 10,000 pay envelopes to as many wage earners. If pay envelope advertising is but one-half as effective as many claim it to be, a bank is certain to secure better results from an investment of \$6 in pay envelopes than is possible by any other form of advertising. At the price of one new account, it reaches nearly 10,000 persons from whom it is not unreasonable to expect many accounts. Banks will pay as high as 50 cents for a wall or desk calendar, which they distribute more or less indiscriminately, one to each person and that person usually a customer. For the price of one calendar, it could buy and distribute pay envelopes to more than six hundred wage earners. In the first instance

the possibility of good results is very limited, in the other case, unlimited.

Everything considered, in what way can a bank reach as many wage earners, at an equally low cost each, and at such a minimum of effort on its part, as by including pay envelopes in its advertising and "new business" plans?

RESULTS

As is the case with newspaper and other advertising there is no way to determine exactly the amount of results derived from the use of pay envelopes. Only occasionally will persons opening new accounts be seen to extract their deposit from a pay envelope.

As with other forms of advertising, a bank can make pay envelopes pay, or by its neglect can see them fail to produce good results.

Money and War

By FORREST L. APPLEBY, Manager Foreign Exchange Department, New York Agency Union Bank of Canada

MONEY is playing such a large part in the conduct of this war that a few remarks relating to its origin and nature may not be altogether out of place.

There is no definite record of the time of its first actual appearance, but it is known that money tokens were in use among the Mongolian tribes thousands of years before the birth of Christ. Since that time, all kinds of articles have been used as money tokens; even to-day among the Esquimaux, Caribou teeth, and in the more remote districts of Nigeria, cowrie and brass rods are current money. The original purpose of money was to assist barter or exchange, and it was not until banking was introduced in the seventeenth century that it had any value

other than its actual purchasing power.

Gold, because of its malleability, decorative value, and power of resisting action of the elements, very soon became the most desired form of money, and principally owing to the Romans became an internationally acceptable form of money many centuries ago. It is only comparatively recently that gold has had a money value as distinct from a value in commodities, and this money value has been fixed arbitrarily by law in the different countries at so much per ounce pure gold, expressed in terms of the currency of the country; for example, in the United States, the price of one ounce of pure gold is fixed by law at \$20.67, and in England at £4 4s. 11d. If it were not for this, it is questionable if gold would be as

steady in value as it is, and if the different nations had not agreed to accept gold in payment for their merchandise, we should find very little use for the metal, as outside its having been made the basis for money and credit, it is of very little value for any other purpose than decoration or surgery. It is probably because the gold custom had been firmly established for so many centuries, and all customs are so hard to change, that civilized nations decided to make it the basis of their currency. If it were not for its present power of being used to create credit, it would be, compared to the cost of producing it, one of the most useless metals known to mankind.

PRESENT DAY MONEY AND WAR

Many other things are included in what is generally described nowadays as money. Present day money in itself consists of bank notes, Government legal tender notes, gold, silver, and other coins, but by far the most powerful factor is the large volume of credit instruments which are based on money, so that one cannot now talk of money without including these credit instruments, of which those best known are bonds, stocks and shares, promissory notes, acceptances, checks, bank deposits, loans, etc.

During the last fifty years, banking and finance have made such rapid strides and the possession of money has become so universal, that people have come to think in terms of money, rather than in terms of commodities. This situation is accentuated by all published returns of our boards of trade, custom houses, balance sheets, etc., being shown in money values instead of quantities and weights of commodities.

It is perhaps for this reason that many people continue to talk about the enormous cost of this war, and to state that the huge indebtedness of some of the belligerents will force them to make peace. Such, however, is not really the case, as although this is the greatest war the world has ever known, it is most unlikely that it will be ended by a shortage of money or credit—no war



FORREST L. APPLEBY

Manager Foreign Exchange Department, New York
Agency Union Bank of Canada, New York

In 1902, at the age of sixteen, Mr. Appleby entered the service of the London City and Midland Bank, London, leaving there in 1905 to take up the position of teller in the London office of the American Express Company, in whose service he interviewed both importers and exporters of almost every known article of produce, and many manufacturers, obtaining a fair insight into the methods by which each trade was financed.

In 1913 he entered the service of the Union Bank of Canada in London for the purpose of taking up the position of manager of their foreign exchange department in Toronto, where he arrived in April of that year. In October last he was transferred to the head office at Winnipeg as superintendent of foreign agencies, and on the opening of the New York Agency in April of this year, was again transferred to New York as manager of the foreign exchange department.

has ever been ended by such a cause. The only factor which is likely to force an end will be a shortage of man power or material. It may be worth remarking that none of the previous wars which were financed on credit have been paid for yet; not even the Civil War. Yet in spite of it all, the world has consistently made rapid recoveries, so much so, that immediately prior to the present hostilities, the individual standard of living, welfare and comfort was higher than ever before in history.

There is consequently no reason for one to adopt a pessimistic view regarding conditions after the war. Although the total cost will be prodigious, one should not be appalled by it, as the major portion will be capitalized and the interest thereon become a permanent charge on posterity.

EFFECT OF THE WAR ON MONEY AND
CREDIT

If any further evidence of the soundness of the present day system of finance and credit were required, it has been amply provided by this war, as in spite of the withdrawal of over fifty million men from productive activity, with the consequent enormous falling off immediately in the demand for credit for trade purposes, and its replacement at a later date by even greater demands for credit by the several governments, the system has without apparent effort taken care of the needs of the moment and not broken down as was feared by some.

With our experience of the novel methods adopted by the different countries to meet the unprecedented situation, it should not be difficult to estimate approximately what is likely to happen to credit after the war. In all probability the amount of credit in existence when peace is ratified will be the minimum amount of floating credit for many years to come, and when the work of reconstruction is commenced, additional credit will be required and supplied.

The means by which this may be effected are many, and a few of them are detailed below:

(1) By increased production of gold;

some countries will probably be prepared to pay a premium for it.

(2) The governments of those countries possessing gold will most likely lend their credit to the support of commercial enterprises which they deem to be of benefit to their community.

(3) Countries having favorable balances of trade will advance credit to others less fortunately situated, to an extent to which they were hitherto unaccustomed and even unwilling.

With the exception that figures will be far greater, there will be very little difference in conditions. We shall go through periods fluctuating between times of cheap money and dear money. Many new opportunities for the employment of credit will present themselves, and while capital will find many means of securing satisfactory returns in its own country, it is safe to predict that it will seek an outlet in foreign investments to a far greater extent than has been the case hitherto. Countries which will most probably present the best inducements to foreign capital are Russia, China, and Africa, as while always having offered great fields for development, comparatively speaking, they have been little exploited in the past.

Much of the world's trade which was formerly in the hands of European nations has been diverted to this country by the war, and it is more than likely that after peace has been made a large proportion of trade will still remain with us, as Europe will be so impoverished that countries will necessarily trade with that one which is in the best position to give credit. There can be no doubt that this position is to-day held by the United States.



A Patriotic Summons

By HON. A. F. DAWSON, President First National Bank,
Davenport, Iowa.

THE time has come for every citizen of the republic—man, woman, and child—to fill his heart with a courageous and a patriotic determination to give the fullest possible measure of his support and sacrifice in order to make victory swift and certain. And when we stop to think of the sacrifices that others are making, how insignificant must seem any sacrifice that can be made by those of us who do not actually go to the front to bear the burden of battle. On every side throughout the United States we see thousands, yes, hundreds of thousands, of the best young men that there are anywhere under the shining sun willing to offer their very lives in defense of the principles and ideals which are all symbolized by the Stars and Stripes. And I say that if a flag is worth living under, that flag is worth fighting for.

If this Government calls upon us for a service, we should remember that it is only once in our whole lifetime that we really have an opportunity to do something for our Government. All the rest of our lives we are spending in the joyful occupation of pursuing life, liberty and happiness, and most of us getting pretty nearly our share as we go along. And so I say, when once in a lifetime the Government does ask us for some slight service in return for all the favors that we enjoy by reason of living under the best Government on earth, then there should be no thought of profit or cash returns. There should be one hundred per cent. patriotism, and if there is anything less than that I am afraid that before the war is over a yellow streak will show out upon the spines of some individuals, but not many.

I know of one of the prominent bankers in Iowa who has set apart his entire income for 1917, and all that he has aside from his living expenses will be devoted in the spirit of true patriotism to the various objects necessary for



HON. A. F. DAWSON
President First National Bank, Davenport, Iowa

the Government to win this war. He takes the big view that it is little enough for any man to give to his country one year's net earnings out of the productive career of from twenty-five to thirty years.

Not many of us went through the Civil War. but we don't need to go

through a great war to know that conditions in war are vastly different than at any other time. War engenders animosities and hatreds, and creates likes and dislikes. And doesn't every one of you know, in the community where you were reared, haven't you all seen examples of the man who has put himself in opposition to his Government, or even in a position of indifference to his Government in time of war, and hasn't that man for all the balance of the years of his life—yes, and his children after

him—felt the lack of respect of the people of that community? War is the time that brings out the stuff that is in men. We are going to live a long time in peace, after this war is over, and the proudest thing that any man can have in his heart, the most useful thing that he can have in the community where he is going to spend the remainder of his days, is to have the people of that community say, "There is a man who, when his country called upon him, did his utmost in response to that call."

How We Handle Liberty Bond Clubs

By H. J. HAAS, Vice-President First National Bank, Philadelphia

THE Christmas Savings Club Plan was originated in December, 1909. It provided an easy method for banks to handle the weekly savings of wage earners and return to them at Christmas time the amount paid in with interest on each deposit all figured and worked into the system.

It was but a step to adopt this plan to provide ways and means whereby ambitious people could make weekly payments and secure a Liberty Bond. This is especially suited to country banks where they are desirous of getting as many people as possible to come into their bank and become accustomed to the atmosphere of a bank with the thought of making them future depositors in the regular way.

The Club plan for weekly payments on account of the purchase of Liberty Bonds was originated by the First National Bank of Philadelphia. The thought we had in mind was to handle a large number of weekly payments as conveniently as possible for the subscribers. Under the Christmas Savings Plan it is necessary for the subscriber to go to the bank each week to make his payments; with a large corporation having many subscribers and being lo-

2215 LIBERTY BOND DOLLAR A WEEK CLASS

Member's Card No. CLUB

This card must be presented when payments are made

is entitled to deposit in our Club, subject to the rules

Liberty Bond Club

By arrangement with THE FIRST NATIONAL BANK, Philadelphia, Pa.

This card is not negotiable or transferable. Payments are due on first of each week, and must be made before the end of the same week.

This card matures one year after date of issue
Interest Paid on Club Accounts

WEEK	1st	2d	3d	4th	5th
Jan. 1st	Jan. 8th	Jan. 15th	Jan. 22nd	Jan. 29th	Feb. 5th
Feb. 1st	Feb. 8th	Feb. 15th	Feb. 22nd	Feb. 29th	Mar. 6th
March 1st	March 8th	March 15th	March 22nd	March 29th	April 5th
April 1st	April 8th	April 15th	April 22nd	April 29th	May 6th
May 1st	May 8th	May 15th	May 22nd	May 29th	June 5th
June 1st	June 8th	June 15th	June 22nd	June 29th	July 6th
July 1st	July 8th	July 15th	July 22nd	July 29th	Aug. 5th
Aug. 1st	Aug. 8th	Aug. 15th	Aug. 22nd	Aug. 29th	Sept. 5th
Sept. 1st	Sept. 8th	Sept. 15th	Sept. 22nd	Sept. 29th	Oct. 6th
Oct. 1st	Oct. 8th	Oct. 15th	Oct. 22nd	Oct. 29th	Nov. 5th
Nov. 1st	Nov. 8th	Nov. 15th	Nov. 22nd	Nov. 29th	Dec. 6th
Dec. 1st	Dec. 8th	Dec. 15th	Dec. 22nd	Dec. 29th	Jan. 5th

cated some distance from a bank this would cause an enormous waste of time. With our plan the corporation, firm, partnership, association or individual employing a number of men start the movement by appointing some one to act as treasurer of their Club. His first duty is to ascertain how many desire to subscribe to a \$50 Liberty Bond by paying \$1.00 a week for 50 weeks, or \$2.00 a week for a \$100 bond. He then makes application to his bank for the required number of Liberty Bond Club cards in the denominations desired. Cards are furnished in duplicate (blue and white for \$1.00 a week payments and brown and white for \$2.00 payments). The white card is issued to the subscriber and the colored card is retained by the treasurer as his record. The face of the card in addition to bearing the name of the subscriber and the title of the Club to which he belongs, has fifty small squares indicating the weekly payments. The subscriber signs a contract on the reverse side of the office card and as payments are made one of the squares on both cards is punched and a corresponding square on the reverse side indicates at all times the total amount paid. (Form A—Front of card; Form B—Back of card). The bank issuing the cards takes a receipt from the treasurer for the amount and denominations of cards furnished also specifying the number of punches supplied (Form C). The record on these receipts is recorded on Form D under the heading of "Delivered." This form has a debit

RULES AND REGULATIONS

The registered holder hereof, in consideration of the mutual promise hereinafter set forth, and by the acceptance of this card, hereby agrees and consents to the following Rules and Regulations:

1. I authorize and empower the company (named on the face of this card) to arrange with the bank also named on the face of this card, to purchase for my account Fifty Dollars (\$50) (For value) of the U. S. Government Liberty Loan Bonds, and to arrange with said bank to loan me the amount of the purchase price. The company is further authorized to apply all deposits when, and as made on this card to the reduction of said loan until the sum of Fifty Dollars (\$50) is paid.
2. That a weekly payment of \$1.00 each week will be made on this card for the next fifty consecutive weeks following the time of my first deposit, as indicated on the face of this card, until the sum of \$50 is paid.
3. That this card is not negotiable (or transferable) and demand cannot be made for the return of any money paid in on same.
4. That in case of any difference between this card and the "Office Card" of duplicate number, I agree to accept the amount punched on the "Office Card" as the correct amount paid by me.
5. That one year after making my first deposit (provided all fifty payments have been completed as agreed), the Treasurer of this Club agrees to deliver to me a U. S. Government Bond \$50 par value, as above mentioned.
6. The Bank is to receive all interest paid by the Government on the bond while in its possession and the interest accrued on said bond from last due date to time of delivery of bond, is to be paid to the bank by me. In the event of my default in the payment of the weekly payments for a period aggregating four weeks, or failure to complete my full payments of \$50 within one year, I hereby authorize and empower the bank, if it deems it advisable, to sell the bond at either public or private sale, without notice to me, and deduct any loss or charge from this amount by reason of said sale, and remit the balance due on this account to the Treasurer of this Club for my account, and the Treasurer's receipt for such balance shall act as a valid and sufficient discharge and release for the bank from all liability.
7. That this card contains all the understandings between the bank and the company and the company and me, and same are bound by any verbal understandings or agreements not herein contained.
8. The object of this Contract is to assist me in the purchase of a Fifty Dollar Government Bond of the issue as above, by weekly payments on my part.

The smallest amount below not punched shows the total amount of money paid in on this account

	\$50	\$40	\$48	\$47	\$46	\$45		
\$44	\$43	\$42	\$41	\$40	\$39	\$38	\$37	\$36
\$35	\$34	\$33	\$32	\$31	\$30	\$29	\$28	\$27
\$26	\$25	\$24	\$23	\$22	\$21	\$20	\$19	\$18
\$17	\$16	\$15	\$14	\$13	\$12	\$11	\$10	\$9
\$8	\$7	\$6	\$5	\$4	\$3	\$2	\$1	

Copyrighted, 1917, by Charles M. Wrighton

Form B

and a credit side which must balance when the records are completed. On the debit side the general heading is "Delivered" and under this are columns for date, serial numbers of cards, number of Bonds represented by cards

PHILADELPHIA 191

Received of FIRST NATIONAL BANK OF PHILADELPHIA, PA.

LIBERTY BOND CLUB CARDS

\$	Denomination	Nos.	to	Inc.	Cards
\$	"	"	"	"	"

LIBERTY BOND CLUB

Treasurer.

Form C

Delivered				Reported Subscribed					
DATE	SERIAL NUMBERS	No. of Bonds		Total in Dollars	DATE	SERIAL NUMBERS	No. of Bonds		Total in Dollars
		\$50.	\$100.				\$50.	\$100.	

Name:
Address:
Business:

Treasurer.

Form D

(divided into two columns of \$50 and \$100), then the last column marked "Total in Dollars," the idea being to so record the cards furnished a Club that it will show how many bonds of each denomination are necessary to meet their requirements. The treasurer may take out more cards than he has subscribers promised or some may change

their minds or he may make some mistake and desire to issue a new card in its place. When cards are returned for any reason they should be recorded on the credit side of Form D. The columns on this side are marked with the general heading of "Reported Subscribed." Under this are columns for date, serial numbers, number of bonds (two columns, \$50 and \$100), and the Total Column marked in Dollars. Space is provided at the bottom of this form for the name of the Club, address, business and name of treasurer.

THE FIRST NATIONAL BANK
Philadelphia, Pa.

191

Gentlemen: completed
We have returned the following "Liberty Bond Cards" issued.

SERIAL NUMBERS	NUMBER OF CARDS	DENOMINATIONS

The records for this side of Form D are secured from the data taken from Form E. This form should be filled out and returned by the treasurer of a Club when cards are issued, returned unissued or when all the payments have been made by a member. This form, in addition to the title of the bank and date states the following:

"Gentlemen: We have issued (completed) (returned) the following 'Liberty Bond Cards.'"

This information is then contained in three columns, "Serial Numbers," "Number of Cards" and "Denominations of Cards." Space is provided below this ruling for the title of the Liberty Bond Club and the treasurer's signature.

If the treasurer of each Club has advised properly the number of cards is-

Name of Company and Treasurer.

Form E

LIBERTY BOND CLUB.

Record of Subscriptions.

ONLY TO BE RECORDED ON ADVICE OF TREASURER OF EACH CLUB.

NAME OF COMPANY	DATE		No. of Cards		Total in Dollars.
			\$50.	\$100.	

Form F

sued to members of their Club and the cards unissued or ruined and returned, and they have been properly recorded on Form D, the debit and credit sides should balance. In order to easily differentiate between the cards issued and returned we have found it advisable to record the latter in red ink.

In order to readily ascertain how many bonds of each denomination have been subscribed for by members of the Club we used Form F with the following heading:

RECORD OF SUBSCRIPTIONS

Only to be recorded on advice of treasurer of each Club.

then the following columns—Name of Company, date, number of cards (2

columns, \$50 and \$100), total in Dollars.

A sheet, Form G, with the same volume is used to record the cards returned. When the Clubs have been closed and all reports are made by the treasurer, the totals of Forms F and G should equal the total columns on both the debit and credit side of Form D. Postings to Form D are made from Forms F and G.

It will so happen that some members of these Clubs will make larger and more frequent payments than one or two dollars weekly and complete their cards in advance of the fifty weeks. The treasurer should then present the completed cards together with his check for the face of the bond and

LIBERTY BOND CLUB.

Cards Returned.

NAME OF COMPANY	DATE		No. of Cards		Total in Dollars.
			\$50.	\$100.	

Form G

LIBERTY BOND CLUB.

Cards Maturesd

NAME OF COMPANY	DATE	No. of Cards		Total in Dollars.
		\$50.	\$100.	

Form H

accumulated interest and receive the bond, interim certificate or full paid receipt of the bank depending upon whether or not the bonds or interim certificates are ready for delivery. The bank having decreased its liability on account of the Liberty Bond Club Bonds that have been delivered should at all times know the total of the bonds delivered and the amount which they must provide for future full paid cards.

Form H has been provided to record

the matured cards. This form is of the same ruling as Forms F and G and differentiated by heading the sheet "Matured Cards." Postings are made from this sheet to Form D debit side under the balanced previous record of "Cards Delivered." When the completed cards equal the amount of cards subscribed the Club has run its course.

(Ed. Note: Specimen copies of each of the forms described may be had by addressing Mr. Haas in Philadelphia.)



National Banks Need Not Classify Money in Vaults

THE Comptroller of the Currency announced on July 19, 1917, that in future calls for reports of condition, national banks will not be required to make detailed statements of the various classes of money in their vaults according to the schedules heretofore used.

Except when needed for statistical purposes, probably once or twice a year, national banks will only be required to report in their periodical statements of condition the money in their vaults under the following heads:

Gold coin, silver and minor coins, clearing-house certificates based on spe-

cie and currency (Sec. 5192 U. S. R. S.), paper currency.

Under the head "paper currency" the national banks will include all gold certificates, silver certificates, national bank notes, Treasury notes, United States notes, Federal Reserve notes and Federal Reserve Bank notes.

When it is desired to secure from the banks a more detailed statement as to their cash holdings for statistical purposes, sufficient notice in advance will be given them to make preparation for supplying such data. It is believed that this ruling will materially reduce the labor of receiving tellers and other bank employees.

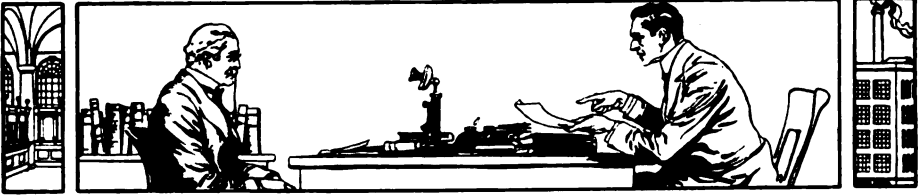

The Business Counselor—The New Factor in Banking

Is the Financial Statement False Gospel?

By GEORGE KINGDON PARSONS

(This is the fourth of a series of articles by Mr. Parsons dealing with the subject of scientific business management and its relation to banking.—The Editor.)

SHOULD the financial statement be taken at its face value? Is it worth what it claims to be worth? Does it, after all, show the true condition of a business?

We have had the financial statement with us since time immemorial, so long in fact that it has been handed down to us as a sort of tradition which must be dealt with reverently. We make obeisance to it in much the same manner as we kow-tow to the ponderous phraseology of legal documents. We are afraid to kick over the traces—to break away from conventional forms—and yet there is a growing feeling among bankers and other men of business that the unsupported financial statement is inadequate and misinforming.

Let us consider the usual form of financial statement which is somewhat as follows, consisting of the gross items of assets and liabilities:

SKELETON BALANCE SHEET
ASSETS

Current.

- Cash.
- Accounts receivable.
- Notes receivable.

Operating.

- Raw materials.
- Goods in process.
- Finished goods on hand.

Fixtures or Capital.

- Land and buildings.
- Machinery and equipment.
- Furniture and fixtures.
- Accrued accounts.
- Sinking funds.

General.

- Investments.
- Personal accounts.

LIABILITIES

Current.

- Audited vouchers.
- Accounts payable.
- Notes payable.
- Accrued interest.
- Accrued pay roll.

Capital or Fixtures.

- Capital stock.
- Funded debt.

General.

- Reserves.
- Surplus.

Contingent.

What does all this mean to the banker, the one who finances industry? Each one of the items is subject to your

challenge. Every banker with whom the author has ever talked on this subject feels the same uncertainty as to the value of the balance sheet. There is always a question regarding the correctness of figures used in computing the value of various raw materials, goods in process, finished goods, land, buildings, machinery, etc. In one instance the author recently discovered in such a statement an item of \$50,000 in the finished goods account. This item should never have appeared, as thoroughly delving developed the fact that it had been included because it was in the inventory. An inspection of the goods in the stock rooms showed that, in the first place, the figures were based on a rough estimate, and, in the second place, that the goods were practically unsalable, having been made years before for a customer who was no longer on the books! Here was a purely fictitious value running into large figures. This is only one of many instances in which the business engineer, working in collaboration with the banker on his industrial account, discovers the inadequacy and unreliability of the financial statement.

Let us look further into this balance sheet. The item of raw materials is perhaps the simplest one. This is a case where a current inventory is essential. The items "Goods in process," and "Finished goods on hand" can not be obtained unless the business is provided with accurate methods of cost finding. The two items named involve not only the used materials but the value of the labor and the indirect or burden expenses. If these are not properly distributed to the goods then the balance sheet is wrong. Herewith is shown an outline of the fundamental operating statement which the banker should have from his customers, which information the banker should insist that his borrowing customer possess.

FUNDAMENTAL OPERATING STATEMENT
MATERIAL ACCOUNT

Charges.

Inventory (at beginning of month).
Purchases (during month).

Credits.

Materials drawn from stores.
(Charged to production direct or indirect.)

Balance.

Value of inventory.
This account can be subdivided in as many accounts as necessary, according to materials used and should be a matter of current record.

PAY ROLL ACCOUNT

Charges.

Total monthly pay roll (direct and indirect).

Credits.

Direct labor (charged to manufacturing).
Indirect labor (charged to burden or operating expense).

Balance.

Accrued labor.

INDIRECT BURDEN EXPENSE ACCOUNT

Charges.

General indirect salaries and wages.
General indirect material.
General indirect burden expense.
Fixed indirect salaries and wages.
Fixed indirect material.
Fixed indirect burden expense.
Departmental indirect salaries and wages.
Departmental indirect material.
Departmental indirect burden expense.

Credits.

Total burden expense on monthly direct labor (completed product or in process of manufacture).

MANUFACTURING OR OPERATING ACCOUNT

Charges.

Direct labor.
Direct materials.
Indirect burden expense general.
Indirect burden expense fixed.
Indirect burden expense departmental.

Credits.

Finished production at cost.

Balance.

Goods in process of manufacturing.

FINISHED PRODUCT ACCOUNT

Charges.

Finished production at cost.

Credits.

Total sales at cost.

Balance.

Value of finished product on hand.

SELLING EXPENSE ACCOUNT

Charges.

All expense incidental to marketing the product.

Credits.

By charging the amount against sales.

SALES ACCOUNT

Charges.

Sales at cost billed out (credited to finished product account.)

Credits.

Sales at selling price.

Balance.

Gross profits.

Charges.

Selling expense.

Balance.

Net profits.

PROFIT AND LOSS ACCOUNT

Charges.

Such losses as have occurred.

Credits.

Net profits from sales.

Balance.

To surplus account.

Statements based on the preceding formula are absolutely reliable. It is not necessary to make frequent physical inventories, as the regular checking of the current stock records reduces error to a minimum.

Through the fundamental operating statement the banker has an infallible means of knowing the manufacturing or operating account, the finished product account, the selling expense and sales account, and finally the profit or loss. This makes it possible to draw off a subsidiary statement, which shows the

gross profits under a trading account and the net profits under a turn-over account.

The necessary figures to fill out the account are taken from operating balances which appear monthly.

On glancing casually at the operating statement you may be prompted impulsively to cast it aside, on the ground that it represents the same kind of accounting that everyone employs, but a careful study of its elements must compel you to admit that among your borrowing customers only a very small proportion can boast of a system which affords anything like as complete a control of the business as is furnished by such a statement, substantiated by an accurate method of cost finding.

A result which produces immediate profits is the facility with which expenses may be reduced and losses stopped when industrial and operating concerns are provided with such fundamental information. No banker is content to close the day without an accurate balance of the cash. Why should the business man be satisfied to wait until the end of the year to discover a diminution of profits? Why should he not insure the prosperity of his business by providing himself with current information whereby he can control the business and know where he stands all the time?

Right here lies the great field for the business engineer—a field in which his relations to the banker become of vital importance. By upholding the banker in his demand upon the borrowing customer and by helping that borrowing customer to satisfy the banker's demands, the engineer or counsellor is proving his worth as "the new factor in banking."



Banking and Commercial Law

CASE COMMENT AND REVIEW

Morris Plan of Industrial Banking

Stein vs. Morris, 91 Southeastern Reporter, 177, passes on the question of property rights in ideas. The defendant is one of the originators of the "Morris Plan of Industrial Banking," the motive of which seems to be to induce impecunious people to invest \$1 a week in \$50 shares of certain "Class C" stock, the stock not to bear any interest until half paid for, and then only four per cent. until entirely paid for, when it shall be convertible into five per cent. "Class B" stock; thus giving the banking concern the use of the purchase money at an exceedingly low rate of interest. The inducement to buy stock is that the holder shall always be able to borrow money on it without other security, an inducement which experience has shown to be sufficiently attractive so that the institutions operating on the "Morris Plan" have proved highly successful.

Plaintiff alleged the plan was the embodiment of a scheme he had evolved and confidentially communicated to defendant, that the latter might in the course of his profession as a lawyer interest the public in it.

The Supreme Court of Appeals of Virginia, in the first place, doubted whether the system was original with plaintiff. It then held, on the assumption that it was original, that he could not have a property right in such a method or idea for conducting business without any physical means or devices for carrying it out, and that as soon as he put it in operation it became the property of mankind. The court was further of the opinion that no commu-

nication to a lawyer for the purpose of having it brought to the attention of the public was privileged.



Constitutional Right to Make a Fool of One's Self

Mr. Justice McKenna, in pronouncing the opinion of the Supreme Court sustaining the constitutionality of the Ohio "Blue Sky" Law (Hall vs. Geiger-Jones Co., 37 Supreme Court Reporter, 217), declared himself not disposed to give very serious attention to the argument that the act violated the right of freedom of contract. He did, however, explain the contention, perhaps feeling counsel had pretty well exploded their theory by their own statement of it, and were "hoist by their own petard." The contention ran thus:

That, since the effect of the act would necessarily be to prevent more or less purchases, it thereby shields contemplated purchasers from the loss of property by the exercise of their own "defective judgments," and puts them as well as the sellers under guardianship. The learned justice then continues: "If we may suppose that such purchasers would assert a liberty to form a defective judgment, and resent means of information as a limitation of their freedom, we must wait until they themselves appear to do so."



Effect of the War on Shipping Contract

Another echo of the Great War is reflected in the case of the Kronprinzessin

Cecile, 238 Federal Reporter, 668. On July 28, 1915, the vessel sailed from New York for Bremerhaven, Germany, via Plymouth, England, for Cherbourg, France. On the evening of July 31st, when about 1,000 miles from Plymouth, she changed her course, and returned to an American port. The master had knowledge of such historical facts conceded to have preceded the outbreak of the Great War as occurred before the sailing of the vessel, and of facts thereafter occurring indicating that his country was on the verge of war with Russia, France and England, and just before changing its course received a wireless message from the home office of his company at Bremen: "War has broken out with England, France, Russia. Turn back to New York." The statement of the message was not true; for not only had no war been declared, but no actual state of war existed between Germany and any one of them. It was not until midnight on the same day that Germany notified Russia that she would mobilize unless Russia demobilized, and not until 7 p. m. on the next day that war between Germany and Russia was declared, and then there was no certainty that France or England would be involved. The master was at that time nearer Plymouth than New York. Without disclosing the message or his purpose to any one, he was, within nine minutes, headed for New York. He was under contract with libelant to deliver specie at both Plymouth and Cherbourg.

The United States Circuit Court of Appeals, Judge Dodge delivering the opinion, said, in effect, that while the master is bound to exercise his discretion for the safety of his ship, passengers, and cargo, his act in this case in turning his vessel back to New York cannot be treated as an exercise of discretion, the message being peremptory, and the statement that war had broken out being false; and the master might have discharged the cargo for Plymouth and Cherbourg and reached a point of safety near his home waters before the actual declaration of war.

It was also held that as an arrest or

restraint, to excuse compliance with the contract, must be an actual and operative restraint, and not merely expected and contingent, the vessel is liable for non-performance of the contract of shipment, the expectation of war not amounting to an actual state of war, whereby in honor of the law of the vessel's flag it would be improper to make delivery at a port where it might be captured or detained; nor could the abandonment of the voyage be justified because of the carrier's duty to take reasonable care of his cargo, for the precautions were obviously for the safety of the vessel and not the cargo, and were intended to place the vessel at a point of safety should hostilities be commenced.

Leading Cases

Indorsement

SOUTH DAKOTA.

*Forgery — Payment — Negotiation—
Warranty—Certification.*

Supreme Court, South Dakota, March 5, 1917.

FIRST NAT. BANK OF PUKWANA VS. BRULE NAT. BANK OF CHAMBERLAIN.

Under Negotiable Instruments Act (Laws 1913, c. 279), section 65, providing that every person negotiating an instrument by delivery or qualified indorsement warrants that it is genuine, and in all respects what it purports to be, and section 66, providing that every indorser not an accommodating party who indorses without qualification warrants to all subsequent holders in due course that the instrument is valid and subsisting at the time of his indorsement, a bank, by its general indorsement as payee of a forged check on another bank, warranted to such other bank that the signature of the maker upon the check was genuine; and, in the absence of any act or change of condition on the part of the drawee bank sufficient to create an estoppel it was entitled to recover from the payee

bank the amount of the forged check upon such warranty, the depositor having sued it and recovered, the contract of warranty existing under section 65 whether the instrument be negotiated by indorsement and delivery or by delivery without indorsement, the warranty created by section 66 not extending to the drawee of an instrument who cannot become a holder in due course.

Negotiable Instruments Act, section 186, declaring the effect of acceptance or certification of a check, and specifying that the drawer and all indorsers are thereby discharged from liability, excludes the application to checks from section 62, providing that the acceptor by accepting the instrument engages that he will pay it according to the tenor of his acceptance, and admits the drawer's existence, his signature's genuineness, and his capacity and authority to draw the instrument, and the existence of the payee and his then capacity to indorse, so that the admissions specified in section 62 have no application to the case of a bank which paid a forged check upon it, suing the payee bank.

(161 N. W. Rep.)

Action by the First National Bank of Pukwana against the Brule National Bank of Chamberlain. From a judgment for plaintiff and an order denying new trial, defendant appeals. Judgment modified and affirmed.

STATEMENT OF FACT AND OPINION

Smith, J. The facts material in the determination of the rules of law applicable in this case are undisputed, and are substantially as follows: One George Kost, a Greek laborer, was employed as one of a track gang on the Chicago, Milwaukee & St. Paul Railway near Pukwana in Brule county. On July 21, 1913, Kost made a deposit of \$200 in the First National Bank of Pukwana. He was identified by the foreman of the track gang; said he could not write. The bank entered the deposit in the ordinary bank passbook and delivered the book to Kost. On August 20, 1913, Kost made another deposit of \$170 which the bank also entered in the passbook. On September 9, 1913, two men appeared at the Brule National Bank of Chamberlain and talked with Pilger, the cashier. One of them had in his possession the passbook

containing the deposit entries above mentioned. The man who accompanied him said his name was Albers; that he was foreman of the gang; that the man with him was George Kost; that Kost could not speak or write the English language; that the men were not going back to Pukwana, and Kost wanted to get his money from the bank there. Pilger told them he could not give Kost the money then, but would take Kost's check and put it through, and if the Pukwana bank paid it, Kost could get the money in a few days. Pilger, the cashier, then wrote a check which was filled up as follows:

"Pukwana, S. Dak. 9/9/1913.

"First National Bank of Pukwana.

"Pay to the order of Brule National Bank, \$370.00, three hundred seventy and no/100 dollars.

his

X George Kost.

mark

"Witness to mark: George F. Pilger."

This check was indorsed "Brule National Bank, Chamberlain, S. D.," and delivered to the Whitbeck National Bank of Chamberlain, which was used as a clearance bank for other banks. The check was marked:

"Paid, Sept., 1913, and the Brule National Bank given credit therefor in clearance."

The check was indorsed by the clearing bank:

"Pay any bank or banker, or order, the Whitbeck National Bank, Chamberlain, S. D. A. C. Whitbeck, Cashier."

The check was credited to the Brule county bank, and charged in clearance against Pukwana bank. It was stamped by the latter bank as follows:

"The First National Bank, Pukwana. Paid Sept. 10, 1913."

The amount of this check was paid by the Brule National Bank of Chamberlain, on September 12, 1913, to the person who signed the check by mark,

and represented himself to be George Kost. The check was a forgery. In October, 1913, the true George Kost demanded payment of the amount of his deposit, which was refused by the First National Bank of Pukwana. He thereupon instituted suit, and in June, 1914, recovered judgment against the Pukwana bank. This judgment was for \$370, the amount of the deposit with seven per cent. interest from October 27, 1913, the date of the demand, and with costs added, amounted to \$415.62, which sum was paid by the First National Bank of Pukwana, on July 29, 1914, in full satisfaction thereof.

In October, 1913, about the time the Pukwana bank learned of the forgery, it tendered to the Brule National Bank of Chamberlain the forged check, and demanded repayment of the \$370 which was refused. The First National Bank of Pukwana thereupon instituted this action against the Brule National Bank of Chamberlain, and on April 16, 1915, recovered judgment in the sum of \$417.97, the amount of the judgment paid to Kost by the Pukwana bank, with interest, together with the sum of \$56.35, paid for costs and attorney's fees by the Pukwana bank in defending that action. From this judgment and an order denying a new trial, defendant appeals.

Appellant assigns as error the allowance as damages of the amount expended by plaintiff for costs and attorney's fees in the case of Kost against the Pukwana bank, in the reception and exclusion of certain evidence, and insufficiency of the evidence to sustain the decision and judgment. It is appellant's contention that under the facts disclosed the plaintiff is not entitled to recover anything whatever. Appellant finds this contention upon what it concedes to be an exception to a general rule. The exception as stated in appellant's brief is that:

"Where a bank pays money on an instrument, purporting to be signed by one of its own customers, it is not entitled to recover the money so paid, because it is held that it is in a better position than any one else to know the

genuineness of its customer's signature."

Appellant, however, concedes that this exception, thus broadly stated, is not generally recognized at the present time. The courts generally take cognizance of a distinction between forgeries, commonly so called, of indorsements on instruments otherwise valid, or cases in which a genuine instrument has been raised in amount by means of a forgery, and those cases in which the signature to the original instrument is a forgery. As pointed out in the note appended to the case of First National Bank vs. Bank of Wyndmere, 15 N. D. 299, the two classes of cases first named are said to be governed by the rules of law permitting recovery of money paid under mutual mistake, while the latter class is controlled by the rule relating to commercial paper.

In the absence of statute establishing a different rule, recovery by the negotiator and indorsers upon the implied warranty of genuineness of a negotiable instrument is held, in many cases, to be limited or controlled by the doctrine of estoppel. And it has been held in a variety of cases that the drawee, who by payment or acceptance or other act has induced the original indorser to change his position to his prejudice, is estopped to recover upon the implied warranty as first indorser or negotiator. On the other hand, it has been held that the original payee or indorser, who by his act has induced the drawee to relax his vigilance in his duty to satisfy himself of the genuineness of the signature of his own depositor, is estopped when he seeks to defend an action by the drawee to recover the amount paid upon a forged draft or check purporting to be signed by his own depositor. In some cases it has been held that the mere act of payment by the drawee estops him from recovering in an action upon the implied warranty of genuineness. But in many of these cases this general rule has been limited by applying it only to forged checks or drafts in the hands of innocent holders in due course, for value, holding that such warranty did not apply to indorsements merely

for collection or to transfer title. *First National Bank vs. Northwestern National Bank*, 152 Ill. 296. The great diversity in rulings, principles, and reasoning in the decisions of the courts of the various states has finally resulted in the adoption, in a great majority of states of what is known as the Uniform Law of Negotiable Instruments. This law was adopted in this state as chapter 279, Laws 1913. Section 65 of that act declares that:

"Every person negotiating an instrument by delivery or by qualified indorsement, warrants:

"That the instrument is genuine and in all respects what it purports to be."

Section 38 defines the term "qualified indorsement" as thus used, to be an indorsement which "constitutes the indorser a mere assignor of the title to the instrument."

Section 30 declares that an instrument is "negotiated when it is transferred from one person to another in such manner as to constitute the transferee the holder thereof," and, if payable to order, is "negotiated by indorsement of the holder, completed by delivery."

Section 65 evidently was intended to create a broader warranty than that created by section 66, and we incline to the view that these two sections and other sections of the act must be construed together in an attempt to ascertain the true intent of this new legislation. Prior to this enactment the courts quite generally held that the implied warranty of genuineness of the signature of the drawer did not extend to the drawee, who was held to be charged with knowledge of the signature of the drawer; and it was held that when a forged instrument had been paid by the drawee, he must bear the loss, in the absence of conduct on the part of the payee which would create an estoppel in favor of the drawee. As above suggested, however, the rule in relation to forged indorsements and raised instruments was different. In

New York it was ruled that an indorser was held to a knowledge of his own title and the genuineness of all prior indorsements, and every part of the bill, except the signature of the drawer. *State Bank vs. Bank of Omaha*, 87 Neb. 351; *White vs. Continental Nat. Bank*, 64 N. Y. 316. There is, however, a line of decision holding that the original payee by indorsing the instrument impliedly warrants, not only to subsequent holders in due course, but also to the drawee, that the maker's signature is genuine. * * *

It will suffice to say that we are clearly of opinion that sections 65 and 66 of the Negotiable Instruments Act, supra, establish the law in this state, and that the Brule National Bank, by its general indorsement as payee, warranted to the First National Bank of Pukwana that the signature of George Kost upon the check was genuine, and that, in the absence of any act or change of conditions on the part of the latter bank, sufficient to create an estoppel, the former bank is entitled to recover the amount of the forged check, upon such warranty. *Gabay vs. Doane*, 66 App. Div. 507.

The New York courts have held, interpreting the Uniform Negotiable Instrument Law as declaratory of the rule in force in that state prior to its adoption, that the warranty of the genuineness of the signature of the drawer does not extend to the drawee, but exists only in favor of subsequent holders in due course for value, upon an unqualified indorsement. *Farmers' Bank vs. Rutherford Bank*, 115 Tenn. 64. But we are of the view that under section 65 an action upon the warranty may be maintained against the party "negotiating" the instrument, either by indorsement or delivery. The two causes of action, one upon the contract of indorsement, the other upon the warranty, are distinct. The right of action against him as indorser is limited by the provisions of section 66, and extends only to subsequent holders in due course. In such an action, no recovery can be had against the drawee, for the simple reason that he is not and cannot

become a holder in due course. It has been so held in many cases.

But under section 65, the contract of warranty exists, or is created by the statute, as against one who negotiates the instrument, and it is immaterial whether it be by indorsement and delivery, or by delivery without indorsement. Where the instrument is negotiated by delivery only, the contract of warranty extends in favor of no holder other than the immediate transferee. Section 65, subd. 4. The negotiator of the instrument, under the correct interpretation of this section, is the person who, either by indorsement or delivery, first puts the instrument into the ordinary channels through which commercial paper goes into circulation. The warranty intended arises upon his act, and not upon his relation to the instrument in any other respect. His obligation of warranty is not limited by the language of the statute to holders in due course, and therefore extends not only to subsequent holders in due course, but to the drawee. This distinction differentiates the two sections, and explains the reason for placing them both in the same statute. *Neal vs. Colburn*, 92 Me. 139; *Farmers', etc., Bank vs. Rutherford*, 115 Tenn. 64.

But section 66, which is an adoption of rules quite universally recognized in commercial law, limits the warranty of genuineness as well as the contract of indorsement, as distinct obligations, to subsequent holders in due course. The drawee is not, and cannot become, a holder in due course, and for that reason the warranty created by that section does not extend to him. *National Bank vs. Bangs*, 106 Mass. 411.

This rule is based upon the assumption that the holder of a negotiable instrument who simply presents it for payment makes no representation as to the genuineness of the signature. *Dedham Nat. Bank vs. Everett Nat. Bank*, 177 Mass. 392.

Appellant, however, conceding that the negotiator warrants the genuineness of the signature of the drawer, contends that such warranty is released when the drawee pays or accepts the instrument,

citing, among others, the cases of *Title Guaranty & Trust Co. vs. Haven et al.*, 126 App. Div. 802, and *National Bank of Commerce vs. Merchants' Am. National Bank et al.*, 148 Mo. App. 1, as sustaining this contention. Both of the states named have adopted the Uniform Negotiable Instruments Law in substantially, if not identically, the same form in which it exists in this state, and the decisions in both cases are founded upon a construction of provisions in their statutes corresponding to sections 185 and 186 of our Negotiable Instrument Law. These sections read as follows:

"Sec. 185. Where a check is certified by the bank on which it is drawn, the certification is equivalent to an acceptance.

"Sec. 186. Where the holder of a check procures it to be accepted or certified, the drawer and all indorsers are discharged from liability thereon."

The Missouri court, following the interpretation given them in *Title Guaranty & Trust Co. vs. Haven*, *supra*, holds that these sections of the act amount to an adoption of the line of decisions founded upon the decision of the English court in *Price vs. Neal*, 3 Burr, 1354, which holds that when the drawee of a check to which the name of the drawer has been forged pays it to a bona fide holder, he is bound by the act, and cannot recover the payment. It will be observed that in all three of these cases the drawee who paid the forged instrument was suing the holder in due course upon the warranty, or the contract of indorsement, and it was held that both the warranty, and the contract of indorsement were discharged by payment or acceptance by the drawee. We have no doubt whatever that section 66, *supra*, is an adoption of the rule announced in these cases, but as we have endeavored to point out *supra* they have no application whatever to the liability created by the warranty under section 65. See *Haven Case*, 196 N. Y. 487. The warranty under that section is an obligation on the part of the negotiator of the instrument, distinct from the contract obligation created by his in-

dorsement, where the instrument is put in circulation by indorsement instead of delivery. And even though the contract of indorsement be held discharged by the operation of section 66, that fact does not affect his liability upon the warranty as negotiator of the instrument.

The New York court, Appellate Division, in the Haven Case, *supra*, interprets the section of their act corresponding to section 62 of our act as a guaranty by the drawee of the genuineness of the signature of the drawer, and holds that payment is equivalent to acceptance. Section 62 reads as follows:

"The acceptor by accepting the instrument engages that he will pay it according to the tenor of his acceptance and admits: 1. The existence of the drawer, the genuineness of his signature, and his capacity and authority to draw the instrument; and 2. The existence of the payee and his then capacity to indorse."

It is clear that when the drawee accepts an instrument, he becomes obligated as upon contract for its payment; but, as to whether the admission of the facts specified in that section amounts to a guaranty, we are not called upon at this time to express an opinion.

"Title Three," of the Negotiable Instruments Act, comprising sections 182 to 187, inclusive, prescribes the rule applicable to checks as negotiable instruments, and defines the rights of parties thereto, and we are of the view that section 186 excludes the application of section 62 to checks, and for that reason the admissions specified in that section have no application in this case.

Section 186 declares the effect of acceptance or certification of a check, and specifies that the drawer and all indorsers are thereby discharged from liability. We are of the opinion that "payment" is not "acceptance." Acceptance, as defined by section 131, cannot be confounded with payment. Section 112 of the New York act is identical with our section 62.

Acceptance, certification or payment of a check, by the express language of the

statute, discharges the liability only of the persons named in the statute, to-wit, the drawer and all indorsers, and the contract of indorsement by the negotiator of the check is discharged by acceptance, certification, or payment. But clearly the statute does not say that the contract of warranty of the negotiator, created by section 65 is discharged by these acts.

We are clearly of opinion, therefore, that the warranty of genuineness arising upon the act of the Brule National Bank in putting the check in circulation was not discharged by payment of the check by the drawee, nor was the Brule National Bank deceived or misled to its prejudice by such payment. The Brule National Bank by its indorsement and delivery warranted its own identification of Kost and the genuineness of his signature. The indorsement of the check by the Brule National Bank was such as to assign the title to the check to its assignee, the Whitbeck National Bank, and the amount was credited to the indorser.

The check bore no indication that it was deposited for collection, and was not in any manner restricted so as to constitute the indorsee the agent of the indorser, nor did it prohibit further negotiation of the instrument, nor did it appear to be in trust for, or to the use of, any other person, nor was it conditional. Certainly the Pukwana Bank was justified in relying upon the warrant of genuineness, which implied the full identification of Kost, and his signature by the defendant bank. This view of the statute is in accord with the decisions of many courts.

An interesting historical side light is thrown upon banking customs in the matter of restricting indorsements along the line of the New Negotiable Instruments Act, by the case of Belmont First National Bank vs. Barnesville First National Bank, 58 Ohio St. 207, which states that the banking business of the country is now done almost universally upon unrestricted indorsements.

Did the trial court err in allowing

attorney's fees and costs incurred in the action of Kost vs. Pukwana Bank, as part of plaintiff's damages? It is respondent's contention that the defendant bank, upon notice of the action, should have defended against Kost's claim. This view cannot be sustained. Respondent's error lies in the assumption that Kost's action was in some way connected with or founded upon the warranty of genuineness of the drawer's signature to the check, by means of which the money was obtained from plaintiff bank, and that Kost was in some way connected with the warranty. Kost was in no manner concerned with the warranty, nor was his right of action dependent thereon. His action against the Pukwana Bank was upon his claim as depositor to recover the amount of his deposit. The only possible defense to that action was that Kost had received the money—a question of fact upon which the defendant's cashier or any other person connected with the transaction might have been called as a witness—but which had no connection with the warranty involved in this action.

It might possibly be that if in this action upon the warranty the defendant bank had given notice to the drawer of the check to appear and make defense and he had failed to do so, the bank in an action against him might recover the amount necessarily expended in defending the action—a matter we do not decide. But this is not such a case. We reach the conclusion that the Pukwana bank is entitled to recover from appellant bank the amount paid on the forged check, with interest from the date of demand, but that the trial court erred in allowing attorney's fees and costs in Kost's action as damages. This does not necessitate a new trial, however, as the amounts thus erroneously allowed appear from the record, and the error can be corrected by modification of the judgment to conform to these views. As thus modified, the judgment is affirmed. No costs to be taxed in this court. 161 N. W., Rep. 616.

Check to Fictitious Person

OHIO.

*Forgery — Liability — Indorsement—
Fraud.*

Supreme Court of Ohio, Jan. 23, 1917.

JONES ET AL. VS. PEOPLE'S BANK CO.

Where the drawer of a check acting in good faith makes it payable to a certain person or order supposing that there is such a person, when in fact there is not a banker is not thereby excused if it pays it to a fraudulent holder upon any less precautions than if it had been made payable to a real person, but in such case is required to exercise the same precautions to determine whether the indorsement is genuine or not.

The determination by a bank of the character of any indorsement involves the ascertainment: First, of the identity of the indorser; and, second, of the genuineness of the signature.

In an action by the drawer of checks made payable in good faith to fictitious parties, believed to be real parties with whom a third party had contracted for the sale of lumber to the drawer, after the names of such fictitious payees had been forged on the backs of the checks and the amounts finally charged by defendant bank against the drawer's account therein, where one of the defenses was that such third person was the drawer's agent, and where there was some evidence to support such defense, the court in its instruction that the rule that a negotiable instrument payable to a fictitious person or order is, in effect, an instrument payable to bearer, needing no indorsement to pass it, applies only when it is made with the knowledge of the party making it, and not when the maker supposes that the payee is a real person and is fraudulently induced to make it payable to a fictitious payee, should have added that if such third person was the drawer's agent, his knowledge was the knowledge of the drawer.

In such case, the drawer of the checks, if it held out such third person as its agent in the matters involved, would be estopped from denying such agency, even though such party was not in fact its agent.

(116 N. E. Rep.)

STATEMENT OF FACT.

Action by C. H. Jones and G. E. Jones, partners under the firm name of J. F. Jones' Sons, against the People's Bank Company. From a judgment of

the Court of Appeals setting aside the judgment of the court of common pleas in favor of plaintiffs, and remanding the case for a new trial, plaintiffs bring error. Judgment affirmed.

This is a proceeding in error to reverse the judgment of the Court of Appeals. C. H. Jones and G. E. Jones, plaintiffs in error, were partners engaged in the business of manufacturing lumber and lumber products at Columbus Grove, Putnam county, under the firm name of J. F. Jones' Sons, and, as such, recovered a judgment for \$2,805.32 in the court of common pleas, against the defendant in error, the People's Bank Company, for payment by the latter of ten checks drawn, with one exception, by J. F. Jones' Sons in favor of fictitious persons. One V. B. Pangle was engaged in like business in said village, and at sundry and divers times bought timber for the Jones company. The Jones company carried on its books an open account with Pangle, in which, with numerous miscellaneous items of credit and debit, appear respective entries concerning certain of the timber hereinafter mentioned and the checks which were the subject of the litigation in the court below. The various checks involved in this case were issued by the Jones company at the instance and direction of Pangle, upon representation by Pangle to the Jones company that he had bought or contracted to buy from the various payees mentioned in said check certain lumber of the amount and value set forth in said checks. The payees in said checks were for the most part fictitious persons, unknown to the Jones company, but believed by them to be real persons with whom Pangle had contracted for the sale of lumber which was to go to the Jones company, and for which the check was payment in whole or in part. The names of the fictitious payees were, of course, forged on the backs of the checks by some one, and the amounts paid by a chain of banks and finally charged by the People's Bank Company, defendant in error,

against the account of the Jones company in said bank.

OPINION OF THE COURT

This case is affirmed upon the memorandum of opinion of the Court of Appeals, particularly that part of it which reads as follows:

"In the present case the jury should have been charged that where part of the amount of a check was actually intended by plaintiff below for Pangle, as the evidence in relation to the one in the name of Fred P. Reidy, shows it to have been, or where Pangle devoted the amount or part thereof of the proceeds of a check, or the equivalent of its proceeds, or part thereof, to the acquiring of the particular timber on account of which such check was in whole or in part, issued, and delivered, as in the instance of the checks in the names of O. A. Earnest, C. Balmer, and Fred P. Reidy, severally, there could be no recovery by plaintiffs below of such amount so actually intended for Pangle, or the sum or sums so devoted to the acquisition of such particular timber. This for the reason that the most obvious fundamentals of manifest justice must preclude recovery, inasmuch as such checks entirely or partially, as the case may be, accomplished the very purpose which they were created to serve."

The Court of Appeals set aside the judgment of the court of common pleas and remanded the case for a new trial, which makes pertinent further suggestions of error that would have justified the reversal.

In the main, so far as the plaintiffs' contentions below are concerned, this is the same type of case as *Armstrong vs. National Bank*, 46 Ohio St. 512, and a part thereof, from the opinion of Minshall, C. J., is here particularly recited, and reaffirmed:

"If the drawer of a check, acting in good faith, makes it payable to a certain person or order, supposing there is such person, when in fact there is none, no

good reason can be perceived why the banker should be excused if he pays the check to a fraudulent holder upon any less precautions than if it had been made payable to a real person; in other words, why he should not be required to use the same precautions in one case as in the other; that is, determine whether the indorsement is a genuine one or not. The fact that the payee is a nonexisting person does not increase the liability of the bank to be deceived by the indorsement. The fact is that an ordinarily prudent banker would be less liable to be deceived into a mistaken payment by a fictitious indorsement such as this was than by a simple forgery. The determination of the character of any indorsement involves the ascertainment of two things: (1) The identity of the indorser, and (2) the genuineness of his signature; and no careful banker would pay upon the faith of the genuineness of any name until he had fully satisfied himself both as to the identity of the person and the genuineness of his signature."

But in the instant case the defendant by answer has so modified the fundamental issues of the *Armstrong Case* as to obviously distinguish the case at bar.

The first defense interposed is the usual general denial. The second defense charges:

"That plaintiffs were guilty of a want of ordinary care and diligence in executing and delivering said checks, and each of them to said V. B. Pangle, and that in the exercise of due care, under the circumstances, plaintiffs could, would, and should have discovered said fraud."

The third defense charges want of due diligence and care upon the part of the plaintiffs after the issue of the checks, and after the bank and the plaintiffs had settled their accounts, averring that more than a year had elapsed from the time of said settlement before notice of the alleged forgeries was given the bank. The fourth defense especially charges:

"That the said V. B. Pangle was in the employ of the said plaintiffs during all of said time in the purchase of timber and other merchandise for the plaintiff, and was held out by the plaintiffs to the defendant to be their agent, with authority to act for them."

The fifth defense especially charges that the plaintiffs carelessly and negligently delayed notifying the bank of said alleged fraudulent practices, that meanwhile said Pangle became insolvent, and that by reason of the delay and the insolvency the bank would be unable to reimburse itself as against said Pangle if it should be determined that said checks were not genuine checks properly indorsed. The sixth defense charges that:

"Said V. B. Pangle was the agent, servant, and employe of plaintiffs, and engaged in acting for them in the purchase of supplies for their manufacturing business, and said several checks were issued by plaintiffs either in payment for supplies before that time purchased by said Pangle for plaintiffs, or were given to said Pangle on account of supplies."

The seventh defense pleads a provision of the *Negotiable Instruments Code* as a valid defense.

As to this seventh defense the trial court charged as follows:

"We charge you, gentlemen of the jury, that the rule of law that a negotiable instrument made payable to a fictitious person or order is, in effect, an instrument payable to bearer and needs no indorsement to pass it to another in the commercial world and affairs, applies only where it is so made with the knowledge of the party making it, and does not apply where the maker or makers, supposing the payee to be a real person and intending payment to be made to such person or his order is induced by the fraud of another to so draw it."

There is error in this part of the charge by reason of the fact that one of the defenses interposed here was that

Pangle was the agent of the Jones company, and there was no inconsiderable evidence offered in support of that defense. The court should have added that if Pangle was the agent of the Jones company in the issuing of such check, Pangle's knowledge was knowledge of the Jones company.

The same vice appears in the next paragraph of the charge, which refers to Pangle as a "third person." Now if, as claimed by the defendant, Pangle was in fact an agent of the Jones company, he was not a third person within the contemplation of that part of the charge.

Again. The fourth defense is to the effect that the Jones company held out to the world, including the bank, said Pangle as their authorized agent concerning matters such as are involved in the case at bar. And yet there is no portion of the charge devoted to this issue as set out in the fourth defense. There is a charge upon actual agency, but not upon the distinctive matter pleaded in this defense. Whether he was or was not agent, the fourth defense charges that the company held him out to the world as agent; and therefore, if such be the fact, it would estop the company from denying agency, even though Pangle was not in truth such agent.

Again. Upon the question of agency, the court charged as follows:

"If you shall find, gentlemen, by a preponderance of the evidence in the case, that the man V. B. Pangle was the agent or representative of the plaintiffs and acting for them as such at the time or times when it is alleged the plaintiffs executed the several checks in question and delivered them to the said Pangle, by him to be delivered thereafter to the said several payees named in said checks, and that the plaintiffs, by so treating and dealing with and through said Pangle, placed it in the power of said Pangle to defraud the said plaintiffs in the matter of the said issuing and delivery of said several checks, and in the matter

of the alleged forgeries, by indorsement, of said checks, and that the defendant bank had no knowledge or notice of the relations, if any, at the time or times mentioned, existing between the plaintiffs and said Pangle in the matter of the issuing, passing, and indorsing of said checks, and further that the plaintiffs did not use ordinary care and prudence in the matter of its alleged dealings and transactions with said Pangle and in the matter of the issuing and delivery of said several checks, then the plaintiff cannot recover in this action, and your verdict should be for the defendant."

It is unfortunate that the court here undertook to combine two or three defenses, any one of which was complete in itself, and practically held that before the defendant could prevail in any one of them he must establish all of them by a preponderance of the evidence. That, of course, is not the law. Each of these defenses, with the issue of fact involved in each, should have been stated separately to the jury, in simple language, and with instruction that if they found the fact to be thus and so, in accordance with such defense, then their verdict should be for the defendant; and thus seriatim, taking each defense.

In connection with the defense of agency, or holding out of agency, it was highly important for the court to charge what agency is, and how such relation of agency may be created. Notwithstanding this was one of the focal points of the case, there is nothing in the charge as to what constitutes agency, or as to how such relation can be established between the parties.

This case, under the pleadings and the evidence, calls for a substantial compliance with the doctrine laid down in the syllabus of *Baltimore & Ohio Rd. Co. vs. Lockwood*, 72 Ohio St. 586.

"In submitting a case to the jury, it is the duty of the court to separate and definitely state to the jury the issues of fact made in the pleadings, accompanied

by such instructions as to each issue as the nature of the case may require."

It might be urged that these errors in the charge were immaterial and technical at best, and therefore should be disregarded. But the question of agency and the holding out as agent, upon which estoppel was invoked, and the question of due care and diligence upon the part of the Jones company, not only in the issuing of checks but in the inspecting of settlements, were the most vital ones in the case to be submitted to the jury, and the instructions should have been pertinent and plain without increasing beyond the legal measure the burden of proof upon the defendant.

Certainly there were many striking and significant facts in this record in the testimony of the plaintiff's own witnesses tending to support the various defenses of the bank, particularly those of agency, holding out as agent, and due care and diligence both in the making of the checks and the inspecting of the settlements; but none of these could be fairly and properly considered by the jury except under proper charge from the court.

Judgment affirmed.

116 N. E. Rep. 34.



Money Had and Received

MISSOURI.

Bank Deposits—Liability.

Springfield Court of Appeals, Missouri,
May 21, 1917.

BALLARD VS. FIRST NAT. BANK OF BOLIVAR.

Where a depositor in defendant bank purchased turkeys from the plaintiff for cash, giving his check therefor, which was not received as absolute payment so as to pass title before the check was paid, and the bank, which refused to pay the check when presented, subsequently received the proceeds arising from the sale of the turkeys with knowledge that plaintiff had not been paid, and applied such proceeds to the payment of a prior check, which it had cer-

tified, and still refused to honor checks given plaintiff, as such proceeds were plaintiff's property he may recover against the bank in an action for money had and received.

(195 S. W. Rep.)

Suit by J. E. Ballard against the First National Bank of Bolivar, Mo. Judgment for plaintiff, and defendant appeals. Affirmed.

Sturgis, J. In December, 1915, and for several years prior thereto, one W. H. Pitts was a wholesale dealer in poultry at Bolivar, Mo., buying and shipping in carload lots to the Chicago market. His banking business was mostly done through the defendant bank. The usual course of business was that plaintiff bought poultry from farmers and local dealers, giving them checks on the defendant bank. When a car of poultry was shipped, Pitts would draw a draft on the consignee for what amount he thought it would stand, and deposit same with a bill of lading in the defendant bank, and same was at once passed to Pitts' credit. Pitts' checks were then paid by defendant without waiting for the collection of the drafts and without Pitts having any real funds to his credit. On December 14 and 15, 1915, plaintiff, a local dealer at Buffalo, Mo., contracted to sell and did deliver to Pitts two lots of dressed turkeys, the payment of which was to be in cash, and in payment of which Pitts gave him two checks aggregating \$421.99. These checks were deposited by plaintiff in a local bank, and were sent by way of St. Louis for collection. They were presented to the defendant bank for payment on December 20th, and payment refused. Plaintiff thereby lost his turkeys, and, Pitts being insolvent, he seeks by this suit to recover from the defendant bank as for money had and received, on the facts presently to be stated. Plaintiff prevailed in the trial court, and defendant appeals.

About the time Pitts gave the checks in question to plaintiff he lost heavily and soon failed. He entirely lost three carloads of poultry amounting to \$12,700, and suffered partial losses on other cars. The defendant bank had taken

drafts and given Pitts credit on those shipments. On December 16th, while defendant was yet hoping that these outstanding drafts would be paid in whole or in part, it had such knowledge of Pitts' financial condition and the improbability of these drafts being paid that it commenced refusing payment on his checks given in payment of the contents of the cars shipped. Defendant evidently knew that unless such drafts were paid or Pitts made additional deposits it would stand to lose these amounts. In this condition of affairs, on December 17th, and while turning down all the local checks given by Pitts in payment of poultry, the defendant bank accepted from him a draft for \$5,400, with bill of lading attached thereto, drawn against the last car of poultry shipped by Pitts. This car was shipped to Loeb, Cooney & Loeb, a commission firm in Chicago, being a different firm than Pitts had been shipping to. This car is designated as "the last car." In that car was placed the turkeys sold by plaintiff to Pitts, but not yet paid for, except by the checks on defendant bank, which defendant later refused to pay. The amount of the draft was placed to Pitts' credit on December 17th, but defendant bank did not collect same till December 22d or 23d. It then collected only \$4,800, as the consignee of the last car would not pay the larger amount, and Pitts, as well as defendant, consented to the reduction. In the meantime, and on the very day this car was shipped, December 17th, plaintiff and other parties, who had sold turkeys which went into the car, learned of the fact that defendant was refusing to pay Pitts' checks. On that day plaintiff, as well as such others, called to see defendant bank as to the prospects of getting their money. Plaintiff says that he showed defendant's cashier the bills for his turkeys, giving the amounts of his two checks, and that such cashier made note on the same that such turkeys went into this last car. The promises and representations made by defendant bank to another party who had turkeys in that car is the basis of the companion case of Arm-

strong vs. Bank, 195 S. W. 562 (this day decided), and which should be read in connection with this case. Plaintiff says that defendant's cashier at that time said to him that this last car, in which were plaintiff's turkeys, had been shipped to a reliable firm; that he was sure the draft would be paid, and the parties who had stuff in that car would get their money. "He said there would be no question about that; that I would get my money for the turkeys I had in the Loeb, Cooney & Loeb car." There is evidence that the cashier also told other parties that all those who had turkeys in that car would be paid when the draft against same was paid. It is also in evidence that on this same day—the one on which the car was shipped and defendant took this draft against it—the cashier had Pitts' bookkeeper to make up and give him a list of all Pitts' local outstanding checks, designating on such list which of same represented turkeys going into this last car, and that this list included the two checks of plaintiff now in controversy. It may be, as defendant's cashier says, that this list was not actually given to the bank till the 18th; but defendant's cashier called for it on the 17th, and knew it would be forthcoming, and that the checks given in payment of these turkeys had not been paid, as indeed none were after December 15th.

The evidence further shows that instead of paying checks given by Pitts in payment of the turkeys which went into this car out of the proceeds thereof, which was more than ample for that purpose, the defendant, on December 17th, paid a check for \$3,776, given by Pitts several days earlier, and *which it had guaranteed*. This check was given in payment of a car of poultry shipped from another town several days earlier, and the defendant bank was later, for the most part, reimbursed by payment of a draft drawn against that car. The defendant then, on December 20th, charged back to Pitts' account the \$12,700 for which it had given him credit on the unpaid drafts for previous cars. This and some other losses exhausted Pitts' ac-

count, inclusive of the \$4,800 which the bank collected on this last car containing plaintiff's turkeys.

The case was submitted to the jury on the theory that if Pitts was to pay cash for plaintiff's turkeys, and gave him checks which proved worthless, because defendant refused to pay same, and thereby Pitts obtained possession of and sold plaintiff's turkeys, together with others, to a firm in Chicago, "and that the defendant bank received the proceeds arising from the sale of the turkeys so shipped, including the turkeys sold by the plaintiff to said Pitts, with knowledge that Pitts had not paid plaintiff for said turkeys so purchased by him from plaintiff, and shipped in said car to Loeb, Cooney & Loeb, then you will find the issues for the plaintiff."

This instruction we think correctly declares the law. This case is, in all essentials, like that of *Pile vs. Bank*, 187 Mo. App. 61, 173 S. W. 50. As there stated, this property was sold to Pitts for cash, the law implying such, unless there is a contrary agreement, and, since there was no agreement that these checks were received as absolute payment, the title to the turkeys did not pass in the absence of payment of the checks. "In the case of *Bank vs. Railroad*, 44 Minn. 224, 46 N. W. 342, 560, it was held that where goods are sold for cash on delivery, and payment is made by the purchaser by check on his banker, such payment is only conditional, and the delivery of the goods also only conditional; and if the check, on due presentation is dishonored, the vendor may retake the goods, even from an innocent subvendee for value, unless he has been guilty of such negligence or laches as would equitably stop him from so doing. That a check on a bank is not payment unless by contract it is so received, and is only payment when the money is received on it, and that there is no presumption that a creditor takes a check in absolute payment arising from the mere fact that he accepts it from the debtor, is well-settled law, there is no question." *Johnson-Brinkman Co. vs.*

Bank, 116 Mo. 558, 570, *Strother vs. McMullen Lumber Co.*, 200 Mo. 647, 656.

When the turkeys were sold by Pitts, or the firm to which they were consigned, they were yet plaintiff's turkeys and the proceeds were his also. There is abundant evidence, if same is not conclusive, that the defendant bank knew when it received the money on the draft drawn against this car of turkeys that it was in part the proceeds of plaintiff's turkeys, and, since the checks for the turkeys had not been paid, the proceeds was plaintiff's money. The defendant, therefore, received money properly belonging to plaintiff with knowledge at the time that it was plaintiff's money, the proceeds of his property, and, having refused to pay it to plaintiff, he is entitled to maintain this action for money had and received. *Pile vs. Bank*, supra; *York vs. Bank*, 105 Mo. App. 127.

There is no merit in the contention that the plaintiff, by receiving these checks and delivering the turkeys to Pitts and allowing him to ship and sell same, thereby waived such cash payment and parted with his title and right to have the proceeds. *Strauss, Pritz & Co. vs. Hirsch & Co.*, 63 Mo. App. 95, 102. Plaintiff accepted the checks believing that they would be paid when presented. When he learned that the checks would not be paid his turkeys were gone. The defendant, however, had been authorized by Pitts to collect and receive the proceeds. The defendant then assured plaintiff that when such proceeds came into its hands he would receive his money. The defendant was thereby agreeing to do only what the law required it to do. Even if it had been plaintiff's duty and he had been disposed to follow his property to Chicago, this assurance by the defendant bank would have excused him. There is no waiver, therefore, in the case. "They had the undoubted right to waive this condition, also to waive payment in cash, and accept the check as unconditional payment, but we do not find anything in the facts to authorize the conclusion that they do so.

A check is not payment, but is only so when the cash is received on it. There is no presumption that a creditor takes a check in payment arising from the mere fact that he accepts it from his debtor. The contrary is the case. Nor that it is a *waiver* of cash payment. * * * According to the principles just stated, the delivery of the grain was conditional upon payment of the check. If the check was not paid, if presented in a reasonable time, then the delivery did not become absolute and the title to the grain never vested in Nathan." Hall & Robinson vs. Railway, 50 Mo. App. 179, 183-184. See, also, Stundon vs. Dahlenberg, 184 Mo. App. 381, 385.

Nor can we sustain the defense that the defendant bank paid out the proceeds of this car of turkeys in good faith on checks drawn by Pitts prior to defendant's having any knowledge that plaintiff's checks were given for the purchase price of these turkeys. Defendant's cashier says he first had knowledge of this on December 18th, when Pitts' bookkeeper *delivered* him the list of local checks issued by Pitts. The defendant evidently uses the word "knowledge" in a very restricted sense, for the evidence is clear that on December 17th plaintiff and others inquired of him as to the payment of plaintiff's and other checks and the prospect of collecting, and the cashier then made a notation that plaintiff's turkeys went in the last car. On that day also

he requested the list of checks of Pitts' bookkeeper, in order to ascertain just what ones were unpaid, and the ones given for the contents of the last car would naturally be among those unpaid.

Moreover, as we have stated, the only check of Pitts' paid by the bank on the 17th was one which it had guaranteed and thereby made *its own obligation*. Later the bank was reimbursed as to this check by collecting the draft drawn against the car for which the guaranteed check was given, and the bank lost only about \$500 on that deal. Of the other checks given by Pitts in payment of poultry, the local ones were being turned down by defendant bank beginning December 16th. Without going further into detail, the evidence clearly shows that the proceeds of this last car was used by defendant bank to make itself whole for losses previously sustained or then impending, and which were charged back against Pitts' account after the bank had knowledge that plaintiff's checks were given in payment of part of the contents of such last car. The defendant had no right to make good its own losses by so using the proceeds of plaintiff's property. Deal vs. Bank, 79 Mo. App. 262.

Other minor errors are complained of, but what we have said sufficiently disposes of same, and shows that the judgment is clearly for the right party and should be affirmed. It is so ordered.

195 S. W. Ref. 559.



Commercial Banking Practice

THIS is the title of a most useful booklet issued by the National Bank of Commerce in New York, and containing the law as well as the rules and regulations governing acceptances, rediscounts and open market transactions, as established by the Federal Reserve Banks.

Since the inauguration of the Federal Reserve System many changes have taken place in banking practice of which bankers and those who deal with banks should be thoroughly informed.

The information in this booklet is well arranged, under convenient headings, and a complete index is provided.

How Bankers Are Doing Their Bit

If any one of the officers of your bank has joined the colors, if you are making special provision for your employees who enlist, if you have started a Garden Club or a Liberty Loan Club or are engaging in any unusual activity incidental to the war, we hope that you will write us about it.

Our idea is simply to record in the *MAGAZINE* what banks and bankers are doing in the war so that our readers may know about their contemporaries in every part of the country and incidentally receive suggestions and inspiration of how they themselves may help in the big task that confronts us.

AMERICAN NATIONAL BANK, OKLAHOMA CITY, OKLA.

This bank has about thirty-two employees and fifteen of them have either enlisted and joined the army or are registered and waiting for the call.

The directors had a meeting on the subject and ordered that all employees who went to the front either by volunteer enlistment or by selective draft process should be paid their full salaries during their term of service, less whatever amount the Government pays them.

As each man who has dependents joins the colors a life insurance policy is taken out on him in the sum of \$2,500 at the expense of the bank and payable to any beneficiary that the employee may name.

All employees who go to the front are assured of the same position at not less than the same salary on their return.

In the case of employees who have dependent families their salaries are paid to their families by the bank each month. In the case of young men who do not have dependents, their salaries are placed in the savings department to compound at four per cent. until the termination of the employee's service.

A "Big Brother" Bureau has been organized among the directors and officers to keep in touch with the families of the employees who go to the front and with the employees themselves to see that they want for nothing and to render any assistance possible to the families who are left behind.

WOOD AND HUSTON BANK, MARSHALL, MO.

Some months ago this bank organized a "Calf and Pig Club," composed of eighty-four boys and girls of the county. The bank furnished them pigs weighing about seventy-five pounds, and will offer prizes this fall to the ones showing best profit. The bank also subscribed for \$70,000 of Liberty Bonds, which is six per cent. of its gross resources.

ROCHESTER SAVINGS BANK, ROCHESTER, N. Y.

This bank has formulated a very comprehensive and simple plan to assist employers in making it possible for their employees to subscribe to the Liberty Loan by paying a certain amount out of each week's salary. Not only does the bank agree to accept payment in weekly installments, but it also agrees to pay interest at three and one-half per cent. on the accumulated payments until the bonds are fully paid for.

IOWA CITY STATE BANK, IOWA CITY, IOWA

This bank has arranged in cases where any of its employees are called into military service or voluntarily go into service, that their positions are kept open for them, giving them an opportunity to return when the war is over. The bank also has agreed to pay them the difference between the amount paid by the Government and the amount of their salary.

The bank also conducts a Liberty Loan Club, which is handled on a small

weekly payment plan. The president has been actively engaged in helping the local Garden Club.

THE OLD NATIONAL BANK, GRAND RAPIDS, MICH.

About April 1 this bank employed the best horticulturist which the Michigan Agricultural College could furnish. They furnished him a Ford roadster and all equipment necessary to turn this community wrong side up from the standpoint of soil. He has done a good job—good enough so that the Department of Agriculture at Washington has sent an expert out to get pointers. The vacant lots that are not now under cultivation are so few as to be decidedly noticeable. The bank reports that it has been too busy providing ambitious gardeners with vacant lots, finding plowmen for their lots and proper seeds to follow the plow, to develop any detailed statistics as yet.

The Old National Bank played an important part in connection with the distribution of Liberty Bonds, the president, Clay H. Hollister, being chairman of the executive committee for Kent County. The bank subscribed for over \$1,100,000, which is more than a third more than the subscription of any other bank in this community.

THE OUACHITA NATIONAL BANK OF MONROE, MONROE, LA.

This bank subscribed to \$150,000 of Liberty Bonds and resold the larger portion of them to customers. About one-half of them have been floated on one or more partial payment plans, all based upon giving the purchaser the bonds at absolute cost without any fee whatever for service, that is to say, three and one-half per cent. interest is allowed on all payments made and the bonds are delivered when they are fully paid for.

Since the war began this bank has lost five men from its working force, who enlisted—two in the State National Guard of Louisiana and three at one

of the officers' training camps in Arkansas.

THE OLYMPIA NATIONAL BANK, OLYMPIA, WASH.

The president and cashier of this bank both spoke before lodges and theatres on the Liberty Loan matter and inaugurated a plan whereby Liberty Loan Bonds could be purchased on a basis of five per cent. or more of the par value down, and five per cent. or more per month until paid—interest at the same rate as the bond.

Although the allotment for Olympia was \$200,000, the subscriptions were about \$225,000.

THE BANK FOR SAVINGS IN SEATTLE, SEATTLE, WASH.

The Bank for Savings in Seattle has helped to its utmost the various relief associations since the beginning of the war.

Its force has subscribed one hundred per cent. to the Liberty Loan, and to the Red Cross. It attends to the Fatherless Children of France, and to the American fund for French Wounded, committees of Seattle. All employees of the bank called to colors will receive for many months the difference between their regular pay and their Government wages.

R. W. Howard is leaving shortly with the Washington State Artillery. A. Auzias de Turenne enlisted at the beginning of the war with the Canadian Artillery and lost one eye at Ypres, and is now back at the bank, while his brother is still fighting at the front with the American Legion, 211th Battalion, Canadian overseas forces.

THE FIRST NATIONAL BANK OF LEWISTOWN, LEWISTOWN, MONT.

This bank, and practically all the banks in this district, have given their best aid in disposing of Liberty Bonds and in raising money for the Red Cross.

Out of the bank, three employees have left, and have successfully passed

an examination to become officers in the infantry, aviation and engineering corps.

THE CITIZENS NATIONAL BANK, RALEIGH,
N. C.

Three young men from this bank volunteered for active service; two were accepted. The third, although under age, resigned his position and enlisted as a yeoman. He passed the physical examination and reported for duty, at which time he was advised that the ranks of the yeomanry were already filled. He, therefore, secured an honorable discharge and is again on the *fring line* at the "Citizens National." The son of the vice-president, Mr. Young, has enlisted and is now on his way to France.

This bank took an active part in placing the Liberty Loan, in subscribing in its own name for a quarter of a million. It took subscriptions payable in weekly and monthly installments and also subscriptions from the farmers, secured by their initial deposit of two per cent., and their pledge on the coming crop of cotton, by the dedication, as it were, of a "Liberty Bale of Cotton." Altogether the bonds placed through this institution amount to more than its combined capital and surplus. Each officer and employee, from president to janitor, are on the "*Liberty Roll of Honor.*"

In addition to this, the bank subscribed to \$100,000 of the British loan of 1918 and \$50,000 of the United States war certificates. Just about the time when the campaign for the sale of Liberty Bonds was at its height, the State of North Carolina also had an issue of four per cent. bonds to dispose of. This institution took \$150,000 of this amount. The above figures show that this bank "Did its Bit" in answer to the call of both State and Nation, by its personal service and by investing its cash resources, to the amount of \$659,650.

NORTH CAROLINA BANKERS ASSOCIATION

By unanimous decision this association at its recent convention voted to

contribute \$2,000 for the purchase and maintenance of an ambulance in France for a period of one year. This action was taken on motion of Colonel John F. Bruton, of Wilson, every man in the assembly hall rising to his feet when President W. S. Blakeney, of Monroe, put the question. The ambulance will be given through the Red Cross Society of the State.

In asking the bankers of the State to take this action, Colonel Bruton dwelt at length upon the hardships that young men of the nation will be called upon to bear in the early future, adding that the ambulance which he proposed might be the means of saving the life of one dear to some delegate present.

FALFURRIAS STATE BANK, FALFURRIAS,
TEXAS

The plan that this bank adopted and which resulted in selling about half of the Liberty Bonds sold was to advertise that if the applicant would pay ten per cent. of the face of the bond applied for in cash and give his note for the remaining ninety per cent., the bank would remit the cash in full with the application. The notes are payable in nine equal monthly installments and bear interest at a rate twenty per cent. below the customary rate.

THE MINNESOTA LOAN AND TRUST CO.,
MINNEAPOLIS, MINN.

This company started a Liberty Loan Club whereby a \$50 Liberty Bond may be bought for \$1 down and \$1 a week, and a \$100 bond for \$2 down and \$2 a week. We allow the depositor interest at the rate of three and one-half per cent. on the payments as they are made, offsetting this by interest earned by the bond for the same period of time.

The bank did considerable advertising in connection with the Liberty Bonds, and also had reprinted a speech of the Secretary of the Interior, Franklin K. Lane, on reasons for United States' entry into the world war. These booklets were given a wide distribution.

THE FIRST NATIONAL BANK OF WEBSTER
CITY, WEBSTER CITY, IOWA

This bank mailed out about 7,000 letters, distributed 3,000 application blanks for loans, used newspaper space very liberally, besides the active personal work of its entire force.

The bank also made an offer to sell bonds to enlisted men on one year's time, taking payments out of each check as received from the Government, and when the boys are discharged from service, offered to either give them their bond subscribed for, or give them cash should they need it.

THE CANADIAN BANK OF COMMERCE,
TORONTO

How soon will any American bank be able to equal this record?

Officers resigned for military service August, 1914-1915, 557.

Officers resigned for military service August, 1915-1916, 1,146.

Officers resigned for military service August, 1916—May 31, 1917, 1,325.

This total of 1,325 represents sixty-five per cent. of the male staff between the ages of 18 and 45; sixty per cent. of the entire male staff, and between forty and forty-five per cent. of the entire staff of our bank. Of our officers 113 have been killed, 201 are wounded, 31 ill, 6 reported missing and 10 are prisoners.

THE UNION NATIONAL BANK, HOUSTON,
TEXAS

Dewitt C. Dunn, cashier of this bank, says:

"While we have no club of our own, we are subscribers to a hog fund for boys in this county; also subscribers to a considerable extent to a Dairy Cow Fund, which has been in operation now for about a year and has been highly beneficial to the farmers of this section. The other banks of this city in connection with ours have subscribed \$100,000 to that fund for the purpose of buying good Jersey cows and selling them to the farmers on long time

at low prices and at a low rate of interest. The plan has worked splendidly and a number of farmers who had no money with which to buy cows availed themselves of the opportunity and are now reaping the benefits.

"Regarding the Liberty Loan, we organized a Liberty Loan Department in this bank and sold bonds to thirteen hundred and eighteen subscribers. The total subscriptions through this institution were \$1,070,000."

ARKANSAS VALLEY BANK, FORT SMITH,
ARK.

The following men from this bank have volunteered for service in the army: Roy Upchurch, Monte Brooksher, Carl Black.

THE FARMERS NATIONAL BANK, TOPEKA,
KANSAS

Glenn W. Shimeall, a paying teller in this bank, has enlisted in the Officers Reserve Corps at Fort Riley.

This bank organized a Liberty Bond Club and allowed its patrons to pay on most any basis they saw fit so that it was paid out within one year. The bank carries the bonds for them and they are to receive same as soon as they complete their payments. The bank placed some 207 \$50 bonds and 130 \$100 bonds, feeling that it was of vital importance that the little fellows as well as the larger investors should feel a personal interest in the country.

THE FIRST NATIONAL BANK, COLLINSVILLE, OKLA.

The assistant cashier of this bank, James O. Colburn, is in the officers' training camp at Fort Logan H. Roots.

ST LOUIS UNION BANK, ST. LOUIS

I regret exceedingly that we did not have a picture taken of the immense crowd which was in our building during the last two days of the campaign, for it would have illustrated very clearly what a stampede we had in the West for the purchase of bonds of small denominations.

The St. Louis Union Bank subscribed

for \$7,000,000 worth of Liberty Bonds for itself and for its patrons, which subscription is said to be the largest west of Chicago.

THE GERMAN NATIONAL BANK, BELOIT,
KANSAS

Two employees of this bank, Jay H. Bracken, a teller, and W. D. Sorgatz, for several years a bookkeeper, are at the Fort Riley, Kas., Training Camp, trying out to be commissioned officers.

In addition the bank has adopted a plan of supplying Liberty Loans to its savings depositors, a deposit of \$2 a week for twenty-five weeks securing a \$50 bond.

THE FIRST NATIONAL BANK, VINCENNES,
IND.

While none of the officers of this institution have joined the colors, one of the directors, Paul W. Bayard, has joined Battery E, after having been on the Mexican border in artillery service last year.

Mr. Bayard was formerly cashier of the First National Bank of Lawrenceville, Ill., and also a director in that institution.

NATIONAL BANK OF THE REPUBLIC, SALT
LAKE CITY, UTAH

This bank has notified its employees that in case they are called it will pay them a sum equal to the difference between their present salary and that which they will receive from the Government, to remain in force during the war.

The employees have also been allowed to subscribe to the Liberty Loan on a monthly payment plan, deferred payments bearing 5 per cent. interest.

THE WILMINGTON SAVINGS AND TRUST
COMPANY, WILMINGTON, N. C.

This bank has distributed to boys in the county thirty-five registered Duroc Jersey pigs, without any cost to the boy, but with the understanding that he will pay back the cost of the pig when he

disposes of the hog next fall or winter.

In this way the boys are not only stimulated to raise food for the pig, but there has been imported a high class strain of stock that cannot be other than beneficial to the community.

The bank is also encouraging each member of our force to get out once a week and work in his (or her) garden.

HARRIS TRUST AND SAVINGS BANK,
CHICAGO, ILL.

Eighteen employees of this bank are already in the Government military service; ten in the officers' reserve training camps, two in the Illinois National Guard, one in the navy, three in the Illinois Naval Reserve, one in the Aviation Corps and one in the Y. M. C. A. Army Division.

In addition to the above a great many other employees have enlisted in some particular branch of the Government military service, but have not yet been called to the colors.

This bank is making up the difference between the salary paid by the Government and the salary each employee drew before he left the bank. In other words, every employee of the Harris Trust & Savings Bank who has enlisted during this war is sure of the same income that he had before enlisting. He is also assured of a position with the bank at the close of the war if he applies for it.

The list of the men who have already been called to the colors is as follows:

FIRST REGIMENT, ILLINOIS NATIONAL GUARD.
Benj. B. McQueen—H. C. Slocum.

U. S. NAVY.
Thomas J. Bryce.

ILLINOIS NAVAL RESERVES.
George C. Baugh, Walter G. Kropp, Fred W. Dower.

Y. M. C. A. ARMY DIVISION.
DeWitt Stillman.

AVIATION CORPS.
C. E. Bradley.

OFFICERS RESERVE TRAINING CAMPS.
Tho. J. Wann., Jr. J. H. McIlvaine
Paul S. Russell F. T. Ward
R. E. Bard Theo. White
H. S. Ronnie G. K. Gould
J. A. Keating E. C. Wampler

AMERICAN SAVINGS BANK, SPRINGFIELD,
MO.

H. R. Awbrey, vice-president of this bank, has been called into service in the United States Army. His address is, Captain H. R. Awbrey, Q. M., O. R. C., Fort Logan H. Root, Little Rock, Ark.

THE MERCHANTS NATIONAL BANK, NEW
HAVEN, CONN.

This bank has opened a Liberty War Loan Club, which has about 3,200 accounts calling for \$50 bonds, about 600 accounts calling for \$100 bonds and a few scattering accounts for \$500 and \$1,000.

THE SECURITY NATIONAL BANK, CHENEY,
WASH.

This bank's quota as a bank for Liberty Loan bonds was \$22,500; \$40,350 was subscribed and paid for.

UNION TRUST CO., SPOKANE, WASH.

Arthur S. Blum, treasurer of this company, writes:

"Eager to be of service to Uncle Sam in this great crisis that is now facing this country, two of our young men successfully passed the examination for entrance to the Officers Reserve Corps, and are now in training at the Presidio, San Francisco, Cal. I am just in receipt of a letter from one of these men, who has received his commission as second lieutenant in the infantry.

"We feel that we are doing our 'bit' when we can say that all of our unmarried men of eligible age are now in the Officers' Training Camp; and it is our policy to keep their positions open for them whenever they are ready to return. As soon as a Home Guard was organized here in Spokane several of our men, including the writer, joined, and have been drilling regularly once a week.

"When the recent campaign was conducted in connection with the Liberty Loan bonds, five of our men devoted their entire time for

two days in the distribution of these securities; and I am pleased to state that we started right at home taking subscriptions, and can report that every employee of the Union Trust Company subscribed to one or more bonds.

"None of our officers or employees have overlooked the opportunity of endeavoring to increase our production of foodstuffs; and am pleased to state that our president, D. W. Twohy, has converted a portion of the beautiful grounds of his home into a vegetable garden, and with the assistance of Mrs. Twohy and his sons, can be seen cultivating this piece of ground, which is bound to be very fertile in its production.

"I believe the foregoing is indicative of the fact that we of the West are mindful of the seriousness of conditions as they exist."

THE PIONEER STATE BANK, DENVER,
COLO.

One of the employees of this bank has enlisted for the Officers' Reserve Corps and was sent to Fort Riley for training there. The bank has a Liberty Loan Club with about five hundred members. This club is worked on the same principal as the Christmas Savings Club, and enables the members to pay up their Liberty bonds at the rate of one or two dollars per week, according to the wish and ability of the subscriber.

The bank has sold \$100,000 worth of Liberty bonds, about fifty thousand of which was paid in cash and the rest through the Liberty Loan Club.

FIRST AND SECURITY NATIONAL BANK,
MINNEAPOLIS, MINN.

A representative of this bank says:

"None of our officers have joined the colors, but of course, like all other large banks, we are losing a large number of our boys who are volunteering for service in one department or another of the army or the navy.

"One thing we had the privilege of doing here was the counting of all the subscription boxes for the raising of

the Red Cross fund. About seventy-five of the older men of the staff worked Tuesday, Wednesday and Thursday afternoons and evenings up to 12 o'clock; and Friday and Saturday of that same week and Monday and Tuesday of last week a smaller number of the men spent a great deal of their time on this. Minneapolis' quota was \$750,000, which was oversubscribed. A large share of this, of course, was in checks, currency and cash, so you can imagine the amount of detail necessary for the counting and proving of this sum. The bank furnished dinner to those who were to work in the evening and the employees, other than this, gave their time gratis, which was done willingly and cheerfully for the benefit of the Red Cross."

SAN FRANCISCO CHAPTER AMERICAN INSTITUTE OF BANKING

The following members of the San Francisco Chapter have already left to join the colors:

Richard Wild, Wells Fargo Nevada National Bank; E. Avenall, First National Bank; Paul Tissot, Crocker National Bank; E. T. Harrison, Crocker National Bank; J. P. Healy, First National Bank; Jas. S. Govan, Wells Fargo Nevada National Bank; J. L. Swindell, Jr., Wells Fargo Nevada National Bank; T. J. Barton, Bank of Italy; Bernard A. Gurnette, Bank of Italy; George W. Hall, Bank of California N. A.; J. Pritchard, 50 Irving St.; A. J. McCallen, Wells Fargo Nevada National Bank; Warren Crane, First National Bank; A. Mackintosh, Bank of California N. A.; J. M. Jones, Union Trust Co.; H. H. Hustable, International Banking Corporation; Clinton Jones, Jr., Crocker National Bank.

The chapter subscribed to a \$500 bond as its financial share towards the carrying on of the war, and also supplied speakers to help the work of the Red Cross, and assisted in giving out literature of all sorts.

NATIONAL BANK OF CUBA

This bank has subscribed the sum of \$200,000 to the Liberty Loan.

"Needless to say," says the secretary of this bank, "the significance of this loan and the splendid way it has been met by the American people, is keenly appreciated by us all, and while there is no doubt about the final result of the great conflict, we all recognize that it

is necessary for the institutions of our respective countries to do their part in the present great struggle."

NORTH BROOKFIELD NATIONAL BANK,
NORTH BROOKFIELD, MASS.

This bank has been particularly active in an effort to cooperate with farmers in the vicinity to finance their requirements for fertilizer, farm implements and other accessories, necessary for the production of crops.

Vice-President Ralph H. Mann and one of the directors, Henry E. Whitcomb, have enlisted in the State Militia and are at present doing active duty.

Mr. Whitcomb has two sons, who left college to join the naval reserve, and in addition to joining the State Militia himself, has subscribed to \$10,000 Liberty Loan bonds.

This bank opened a Liberty Loan Club on the weekly payment plan, enrolling about five hundred members.

A strenuous campaign waged by the local Liberty Loan Committee resulted in subscriptions to Liberty Loan bonds, handled through this bank, of over \$75,000.

THE FIRST NATIONAL BANK, WESTWOOD,
N. J.

This bank disposed of Liberty bonds to the amount of \$102,350. These went to 510 subscribers, and at least three-quarters were paid on the instalment plan at \$1 per week for a \$50 bond and larger amounts in the same proportion.

THE NATIONAL BANK OF WAREHAM,
WAREHAM, MASS.

This bank joined with the local farm bureau in endeavoring to have more land tilled this year in the vicinity than ever before, and agreed to finance any one who desired to purchase fertilizer and seed that would constitute a fair business risk.

In connection with the Liberty Loan the bank organized local Liberty Loan Committees in the different towns which it serves as a banking institution,

and sold over five hundred \$50 and \$100 bonds on the ten-payment plan of \$5 per month for the \$50 bonds, and \$10 per month for the \$100 bonds. In a number of other instances it agreed to carry the bonds for a limited time for its customers at the rate of three and one-half per cent.

THE FIRST NATIONAL BANK,
CHILlicoTHE, OHIO

The board of directors of this bank has agreed to hold the positions of employees who enlist and pay their salaries, less the amount of Government compensation paid them.

OAK PARK TRUST AND SAVINGS BANK,
OAK PARK, ILL.

Paul E. Zimmermann, the cashier of this bank, writes:

"Our bank has organized a Liberty Loan Club with 209 members. It has been our experience that the subscribers of this club are finding this a very helpful method of thrift and are enthusiastic to help finance the Government.

"Incidentally we are sure to enlist many of the younger people to become permanent savings depositors of our institution.

"While the writer has just passed the years permitting him to enter the Officers' Reserve, we nevertheless have done our bit at Plattsburg preparatory to the call of the Government. Five of our boys have registered and stand a very good promise of serving their country."

THE CITIZENS NATIONAL BANK, TILTON,
N. H.

"While this is a comparatively small community," writes Arthur T. Cass, cashier of this bank, "we have about one hundred and twenty-five gardens under the care of our committee on food production. They are being taken care of by various individuals in the town.

"The committee procured the free use of the land and had the same plowed and harrowed, all ready to

plant, and where necessary helped in the procurement of seed.

"We have a Liberty Loan Club, in which the subscribers are paying \$1 and \$2 a week toward buying Liberty bonds.

"In our Liberty Loan subscriptions we have about four hundred purchasers. The writer with one assistant, in one hour and a half, procured eighty-five subscriptions from one mill, aggregating \$5,000, and the largest of which was \$150.

"This is a case where we are all obliged to do 'our bit,' and are more than glad to do it."

Mr. Cass has a son at the Plattsburg Training Camp.

BANCA COMMERCIALE ITALIANA

The total staff of this bank amounted, before the war, to about 3,200. When Italy declared war 1,500 had to join immediately, and since another 300 have been called up. The percentage has been especially high in the London office, where about sixty per cent. of the permanent staff have joined the colors of the various Allied Armies.

By a decision taken at the beginning of the war and confirmed again recently by the board, practically the whole staff receives full salary (this involves a yearly expenditure of three million Italian lire). Furthermore, the situations are all kept open until the return of peace.

So far it has had about fifty casualties among the men, some of whom have given their lives under circumstances which have deserved special recognition. One of the London clerks, Second Lieutenant (Acting Captain) John Potter, was awarded the D. S. O. for conspicuous gallantry, and many of his colleagues in the Italian Army have died under similar heroic conditions.

In addition, the head office in Milan, has opened in that city a hospital—the Villa Borghi—which has been equipped in the most modern way and is being maintained at the personal expense of the directors and general managers. This institution has received much praise for its installation and has re-

peatedly had the honor of visits from prominent personalities, such as the Italian Prime Minister, Cardinal Ferrari, etc.

The bank has also contributed very largely to war relief committees and its liberality in this respect has received many public tributes.

The staff of the London office have organized a section of the War Savings Association on the same lines as in other local institutions.

THE INDUSTRIAL SAVINGS BANK, FLINT,
MICH.

Two of the employees of this bank are now with the colors. These and others who go will be taken care of when they come back ready for work. Others have applied and been rejected on various grounds.

The bank subscribed for its own requirements and the needs of its customers' \$500,000 in Liberty Bonds. A Liberty Loan Club has been organized permitting customers to pay for bonds on a two per cent. a week basis.

The bank has also donated to the Red Cross Fund and got out letters to aid local committees when that campaign was on.

It has offered a number of prizes in connection with the city garden plan for school children, and has used its advertising space from the first to help in any way possible various activities.

THE BANK OF BRAYMER, BRAYMER, MO.

D. Irving Farrar has resigned his position of assistant cashier and director of this bank and has enlisted in the United States Army, in Base Hospital No. 28 of Kansas City, Mo., and is awaiting the call to go to the front.

THE UNION BANK OF MANCHESTER,
LIMITED

This bank has helped in the issue of all the war loans, both English and French, and subscribed for large amounts thereof.

It has also subscribed for large amounts of exchequer bonds and Treasury bills.

It has granted special facilities at

low rates of interest to persons desirous of taking up war loan, "war savings certificates," etc.

It has taken part in financial operations on behalf of the British Government in New York.

It has assisted in financial operations in England on behalf of the Italian and Russian Governments.

It has assisted the British Government in financing imports of special articles.

The bank has contributed considerably to Red Cross, and other funds.

The bank, in dealing with its staff, has paid full salary to all those who joined His Britannic Majesty's forces for the first twelve months, and now pays full salary, less a deduction of an amount equal to half the army pay, to each individual. Each member of the staff serving in His Majesty's forces, therefore, receives full bank pay, plus half his army pay.

The bank makes a special grant in respect to the high cost of living to each member of the staff up to a certain limited salary and makes a substantial allowance in respect of the high price of food to those who are householders.

The bank has paid a war bonus each year to every member of the staff according to his salary.

The members of the staff have joined His Majesty's forces to the extent of fifty-seven per cent. of the total staff at the outbreak of war, being practically all the men of military age, that is to say between the age of 18 and 41, and medically fit.

More than half the staff now consists of lady clerks, whereas none were employed before the war.

Members of the staff who have not joined the forces are doing extra duty, and working longer hours, and have curtailed their vacation by fifty per cent.

Practically all the members of the staff who have gardens attached to their homes are growing vegetables instead of flowers.

Eight per cent. of the members of the staff who joined His Majesty's forces have been killed, and a memorial tablet has been erected at the head office

of the bank on which the names are inscribed.

LLOYDS BANK, LIMITED

The number of the staff at the outbreak of war was just over 4,300. Practically all those who were of military age volunteered, and up to the present time about 2,350 have left for service. Their places have been temporarily filled by the appointment of over 2,000 women and nearly 1,000 men, and over 500 of the post-war staff have also joined the forces, making a total of nearly 2,900 on service. Up to the end of June last, 196 had been killed in action or reported as "missing, believed killed," 385 had been wounded, over 100 of whom had been "invalided out," and eleven were prisoners of war. A large number of those serving have been promoted or decorated for gallantry, including nineteen military crosses, nine military medals, and several foreign orders.

Those who were away and who belonged to the pre-war staff are receiving from the bank the difference between their service pay and their salaries, and special allowances have been granted to many who accepted commissions.

In order to assist and encourage the staff, a War Savings Association was formed in 1916, with the result that over £74,000 was invested by them in War Savings Certificates issued by the Government. In connection with the five per cent. War Loan at the beginning of the year, the bank made advances to the extent of over £170,000 to the staff, on special terms as regards rate of interest and repayment, in order that they might subscribe freely to the loan.

The work entailed by the various War Loans, Exchequer Bond issues, etc., has been enormous, and the staff remaining at the bank have, generally speaking, had to work long hours of overtime. The introduction of women clerks has been a great success and some of them are now doing work which a few years ago would have been thought impossible for a woman.

The chairman of the bank, Sir Richard Vassar-Smith, Bart., has rendered

great services to the Government and the country since the outbreak of war. He was a member of Lord Faringdon's committee to investigate the question of financial facilities for trade, the outcome of which was the British Trade Corporation. He was also one of the committee appointed to inquire into the winding up of German banks in London. In addition he is president of the Institute of Bankers, and was until recently the chairman of the London Clearing Bankers committee. His services have been deservedly recognized by the conferment of a baronetcy.

The deputy chairman of the bank, Mr. J. Beaumont Pease, after serving for a period in France with the Australian Hospital Ambulance, returned to England, and has been very actively engaged on financial matters.

In the early part of last year an agreement was come to between Lloyds Bank, the London County and Westminster Bank and the Credito Italiano for the formation of two new companies, the British-Italian Corporation in England and the Compagnia Italo Britannica in Italy. The object of the two companies is the development of the economic relations between Great Britain and Italy, and the promotion of undertakings in the commercial and industrial field in Italy. Mr. Pease took a prominent part in the early negotiations, and has been elected chairman of the British Company.

Mr. Henry Bell, the general manager, has also given unstinted time to national matters by his advice and assistance to various departments of the Government, and his presence is as well known at the Treasury and the Board of Trade as any permanent official. He was chosen by the Chancellor of the Exchequer to be a member of the committee to consider schemes for attracting the savings of the working man, and his opinion on financial matters is very greatly valued.

THE LONDON AND SOUTHWESTERN BANK, LIMITED

At the outbreak of war the total of the male staff of military age, exclud-

ing messengers, was a fraction under eighty per cent. of the entire male staff of the bank. Of the total of staff of military age upwards of ninety per cent. have joined the colors. The balance, with the exception of twenty-four, is made up of men attested under the "Derby" scheme, but not yet called up.

The roll of honor (total casualties to date) amount to eighty-four killed and about one hundred wounded.

The decorations won by the staff on active service are as follows:

Five military medals.

Six military crosses.

Four distinguished conduct medals.

One Italian bronze medal for valor.

A considerable number of the male staff of over military age are serving as special constables and in various volunteer training corps, liable to be called for home defense. Others have given their services in the different Red Cross and similar associations.

The bank's chief officers have been frequently called upon to give advice to the Government in regard to the questions arising out of the war. In this connection should be mentioned the recent knighthood conferred upon the general manager, Sir Herbert Hambling, for services rendered to the Treasury.

The bank has played an important part in securing the success of the various national war issues and while contributing in a large measure itself and assisting its customers to contribute by making them advances at low rates of interest the directors have also instituted schemes to assist members of the staff to take up:

(1) War Savings Certificates.

(2) War loan, payments being made in instalments over long period of years.

BROWN BROTHERS & CO., NEW YORK

This well-known firm makes announcement that during the war letters of credit will be issued free of commission to officers and men in the United States Army and Navy and to those engaged in Red Cross or Y. M. C. A. work. To facilitate this work a special representative of the firm has been sent

to France, with headquarters at the Credit Commercial de France, 20 Rue Lafayette, Paris.

CHICAGO INSTITUTION FURNISHES A NUMBER OF OFFICERS

The Chicago financial district is furnishing its quota of officers for the new American army.

One institution—the Harris Trust and Savings Bank—has already supplied six captains, one first lieutenant and two second lieutenants. Three men from this institution are now officers in the navy and seventeen other employees have enlisted in various branches of the military service, including three men in the aviation corps and three in the second officers' training camp.

The six army captains are Roy C. Bard, H. Sevier Bonnie, S. K. Gould, J. H. McIlvaine, Thomas L. Wann, Jr., and Theodore White.

THE BLUEFIELD BANK, BLUEFIELD, W. VA.

Richard B. Parrish, cashier of this bank, writes:

"We subscribed for \$25,000 of Liberty bonds, and have sold most of them, having received 125 subscriptions, the largest single subscription being for \$1,000.

"As soon as we could get it, we put in a partial payment club. We advertised it very extensively and were well satisfied with the results.

"We have already a partial payment club for the next issue of Liberty bonds and intend putting more effort in it and hope to dispose of at least \$100,000 through the club, as we will make a house to house canvas. A number of things have been learned by us in this campaign that will be of advantage in the next.

"Inasmuch as we only opened for business the 1st of March, this year, we feel that the results we got from our club were exceedingly good, and exceeded our expectations.

"We have suggested to one of our department store customers that he give rebate checks on cash purchases, redeemable at this bank for 50 cents each

as part payment on a Liberty bond. That is, if the purchase is \$10, the customer will receive a rebate check for 50 cents. The check is drawn direct on this bank with the conditions embodied in the check that this bank will pay same only on condition that it is used as a first payment on a bond or a future installment on the partial payment plan. Of course, if the customer buys \$20 he gets two checks, which would cover his whole first payment on a bond. The scheme looks good to me and I believe he will use it next time."

THE PEOPLES NATIONAL BANK,
MARLBOROUGH, MASS.

The banks in Marlborough are all operating Liberty Loan Clubs on the fifty-week payment plan and in addition received full paid subscriptions and subscriptions on the government plan. The total subscriptions received in Marlborough number 2,951, and aggregate over \$485,000. As allotment was \$300,000, it was oversubscribed 60 per cent.

TWELVE ENLISTED MEN IN THE ME-
CHANICS AND METALS NATIONAL
BANK

The Mechanics and Metals National Bank of New York City is well represented in the service of the United States. Twelve men have enlisted, one in the navy and eleven in the army. Six of them are now in active service.



The Citizens National Bank of Lancaster, Ky., a bank of \$50,000 capital, subscribed \$35,000 of the Liberty Loan allotment to Garrard county, which was

\$100,000. The president, B. F. Hudson, is chairman of the Garrard County Liberty Loan Committee.



The Second National Bank of Erie, Pa., sold over seven hundred thousand dollars of Liberty Bonds during the recent campaign.



The State Bank of Lakeland, Florida, has a Liberty Loan Club which enables its members to purchase bonds on the weekly payment plan.



S. K. Nash, assistant cashier of the National Bank of Cumberland, N. C., is at present in military training at Fort Oglethorpe, Ga.



The Citizens National Bank of Harrisonville, Mo., is furnishing its customers Liberty Bonds on the weekly payment plan.



The Peoples Bank of Penns Grove, N. J., has organized a Liberty Loan Club, receiving payments as low as \$1 per week and allowing interest on deposits in the club at the rate of three and one-half per cent.



Since early spring the Commercial Bank of Menominee, Mich., has been using its advertising space to promote the "plant and save" campaign. It has also organized a Liberty Loan Club.



International Banking and Finance

The Organization of a Foreign Department

By HAROLD A. ROBINSON

With the National Bank of Commerce in New York

ONE of the most interesting, and, at the present time, one of the most important departments of a large modern commercial bank is its foreign department. It is more important now than ever because the United States has entered upon an era of international banking, and it is only by rendering efficient service, not only to the merchants of this country, but also to the commercial interests of foreign countries, that the large banks of the United States can hope to maintain a dominating position among the financial powers of the world.

To render service comparable with that rendered by the international banks abroad the foreign department must be directed and must work in the most efficient manner possible. The organization of the foreign department of the National Bank of Commerce in New York is typical of that of the largest American commercial banks. To make a description of its work more vivid, the accompanying diagram has been prepared.

Without going into a full, detailed description of the particular duties of the officers in charge of the department, the following will serve to supplement the diagram by analyzing the general work of the department.

THE BILL OF EXCHANGE AND OUTGOING COLLECTION DIVISIONS

It is the work of these divisions to collect debts due to the banks, merchants, and others in this country from banks, merchants and others in foreign countries. These debts arise in various

ways, but there is always some sort of evidence of the debt—either a draft on a foreign firm, or bank, or a coupon, representing amounts owed to persons in the country. The bill may be drawn for a stated sum either in United States dollars or in a foreign currency.

When such bills are particularly well secured, either by the credit standing of the drawer, or by accompanying shipping documents, the bank through the bill of exchange division, is usually willing to purchase, i. e., negotiate them, paying the proceeds to the former owner of the draft, after allowance for interest and collection charges.

The bill is sent forward by the bank to its foreign correspondent for collection. When duly collected the proceeds of the bill are placed to the credit of the bank for whom the bill is collected.

The important distinction between the work of the bill of exchange division and that of the outgoing collection division is this: The bill of exchange division purchases or negotiates the drafts of customers, paying them the proceeds, and then forwards the bills abroad for collection. The outgoing collection division merely sends the bills abroad for collection and pays the proceeds of such drafts to customers in this country only upon receipt of such funds from the collecting agent abroad.

THE CABLE DIVISION

All the cables for the bank are received and dispatched by this division. It codes and deciphers or translates all messages which require such action. At

KEY TO CHART

- 1—Vice-President—General supervision.
- 2—Assistant Cashier—Negotiations with customers and new business.
- 3—Manager—Exchange Operations.
- 4—Assistant Cashier—Commercial Letters of Credit.
- 5—Assistant Manager—Direction of clerical force.
- 6—Assistant Manager—Commercial Letters of Credit.
- 7—Assistant Chief Clerk—Supervision of clerical work of Department, pays, drafts, etc.
- 8—Assistant Chief Clerk—Direct charge of Cable Division, assists in Exchange operations.
- 9—Bill of Exchange Division.
- 10—Outgoing Collection Division.
- 11—Incoming Collection Division.
- 12—Draft Division.
- 13—Correspondents' Draft Division.
- 14—Payments Division.
- 15—Incoming Deposits Division.
- 16—Incoming Mail Division.
- 17—Bookkeeping Division.
- 18—Customers' Statement Division.
- 19—Auditing Division.
- 20—Stenographic Division.
- 21—Translating Division.
- 22—Outgoing Mail Division.
- 23—Filing Division.
- 24—Telephone Exchange, Messengers and Pages.
- 25—Cable Division.
- 26—Domestic Credit Division.
- 27—Foreign Credit Division.
- 28—Import Commercial Credit Division.
- 29—Export Commercial Credit Division.
- 30—Commercial Credit Division, Auditor.

*ORGANIZATION OF THE FOREIGN DEPARTMENT
NATIONAL BANK OF COMMERCE IN NEW YORK*

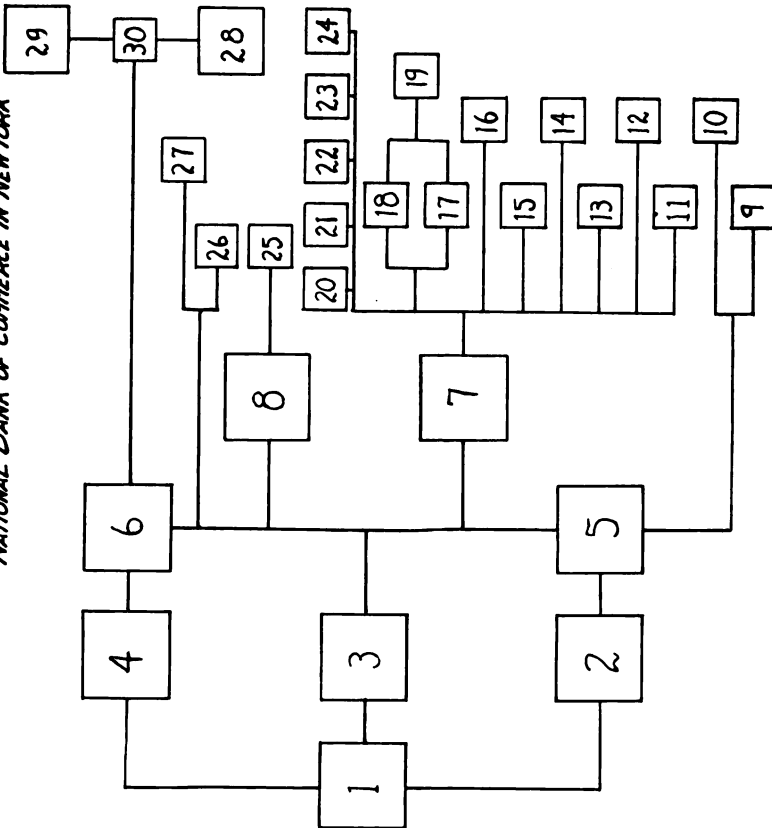

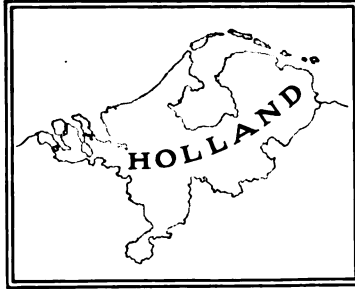

INTIMATE relations with important banking institutions in Holland enable customers of the Irving to carry on business with that country in a highly satisfactory manner.

IRVING NATIONAL BANK

WOOLWORTH BUILDING



NEW YORK

Strictly A Commercial Bank

Resources over \$100,000,000

the present time the use of codes to many countries is prohibited. Ordinarily however, in order to save heavy expense, nearly all cables are coded.

An important duty of this division is to order payments abroad. It may be necessary or advantageous for a party in this country to make a payment abroad immediately. He will, therefore, purchase a "telegraphic transfer." This is merely a request by the bank in this country transmitted by cable to the bank abroad for the person ordering the payment in this country.

The cable is ordinarily used for what are known as "arbitrage transactions." These transactions are briefly as follows: Each day, quotations of the rates prevailing in foreign markets are received by cable. When there is an evident disparity of exchange rates between two or more cities, the exchange operator by buying exchange in one or more centres and selling the same in the others equalizes such disparities.

The cable is used to make transfers between banks in the same country as well as between banks in different foreign countries.

THE DRAFT DIVISION

Drafts drawn on the various foreign correspondents are issued by this division. This, like the cable transfer, constitutes a means of transferring funds between two countries. Another means is by what is called "letter payments." This is merely an order by letter on a foreign bank to make a payment abroad. These transactions are similar to those described as "telegraphic transfers," being different only in the fact that "telegraphic transfers" are requested by cable, and "letter payments" are made by mail.

Another duty of the division is to issue letters of credit and travelers' checks for persons requiring them in their travels abroad.

CORRESPONDENTS' DRAFT DIVISION

Frequently, banks in the interior of the country desire to issue drafts on foreign banks. By special arrangement with the National Bank of Commerce in New York, the country banks are enabled to draw drafts directly on foreign banks. Such drawings are advised by the interior bank, to the National Bank of Commerce in New York, who in turn notifies its foreign correspondents to honor such drawings. In order to inform the interior banks of the foreign exchange rates prevailing in New York city, rate cards are regularly sent them by the New York bank.

BOOKKEEPING DIVISION

Two main sets of ledgers are kept by the foreign department. One set is a control over the accounts kept in foreign banks. These are kept both in foreign currencies and in United States dollars. These accounts are called "foreign accounts."

The other set consists of accounts which foreign banks maintain with their New York correspondents. These are called the "dollar accounts."

CUSTOMERS' STATEMENTS DIVISION

It is the custom to render a statement of the accounts held by the foreign department for foreign banks at stated intervals. These statements summarize the various transactions which pass over "dollar accounts."

AUDITING DIVISION

All the work of the department is audited by a foreign exchange auditor who is connected with the auditing department of the bank. Due to the specialized type of work in the foreign department it is necessary to have one who is absolutely familiar with its functions.

The auditor checks up the entries made to the daily journal and in addition examines all debit and credit tickets. It is also the duty of the auditor, with a member of the foreign department, to receive and examine all

registered mail. A further important duty of the auditor is to receive the statements of the accounts held in foreign banks and to reconcile them with the accounts as they stand on the books of the foreign department.

INCOMING COLLECTION DIVISION

Just as the bill of exchange and outgoing collection divisions send forward various items such as bills of exchange, drafts, coupons and other evidences of a debt due to merchants in this country from merchants abroad, so the incoming collection division receives items for collection, representing debts owing to merchants in foreign countries, by merchants in this country.

When the item is in currency other than that of the United States, it is the custom to make the collection converting the foreign account into dollars at the prevailing market rate of exchange for that currency in New York on the day of payment.

In case of a bill drawn at so many days' sight, being received for collection, the item is first presented to the drawee for his acceptance. After acceptance the bill is held until maturity and then presented to the acceptor for payment. The proceeds are then either placed to the credit of the "dollar account" of the bank requesting the collection, or are remitted directly to that bank if it so requests.

PAYMENTS DIVISION

Foreign banks frequently request payments to be made to parties in this country either by cable or by letter. These payments are made against receipt in duplicate—original is forwarded to the bank requesting the payment and duplicate retained in the files of the paying bank.

INCOMING DEPOSIT DIVISION

It is the work of this division to receive all deposits made for the account of foreign correspondents. As each deposit is received advice is sent to the bank for whose account the money is received, either by cable or by letter.

The First National Bank of Chicago

welcomes and appreciates the accounts of banks and bankers. Its extensive clientele, developed during more than fifty years of consistent, considerate service, is splendid endorsement of the agreeable and satisfactory relations maintained with correspondents.

Capital and Surplus, \$20,000,000

JAMES B. FORGAN
Chairman of the Board

F. O. WETMORE
President

IMPORT COMMERCIAL CREDIT DIVISION

Probably the most important work of the foreign department is that of financing imports and exports by means of commercial credits. In analyzing the work of these divisions it will best serve the purpose to describe typical transactions.

We will assume that an American merchant desires to make a purchase of hides in Argentina. The dealer in Buenos Aires will quote better rates if it can be arranged that he get his money in Buenos Aires on delivery of the shipping documents. The easiest manner for the American importer to arrange for such a payment is by a commercial letter of credit. He, therefore, applies to the foreign department of the National Bank of Commerce in New York, advising the bank as to the amount of the credit, the name of the beneficiary, the terms of the credit—such as length of time of drafts to be drawn, the terms of shipment, and the documents against which payment is to

be made. When the letter of credit is delivered by the importer to the Buenos Aires exporter it is equivalent to his receiving a bank guarantee that the National Bank of Commerce in New York will accept all drafts drawn under the credit and pay them at maturity. In the letter of credit it is specified how the drafts should be drawn, what goods and what quantities are to be shipped; what shipping and what other documents should be attached to the draft, whether or not insurance on the shipment is to be covered by the exporter, and when the credit expires.

When the shipper in South America receives this letter of credit he takes his documents and draft to any bank in Buenos Aires, where it will be readily negotiated because of the credit status of the National Bank of Commerce is well known. After purchasing the draft, to which are attached the requisite documents, the bank in Buenos Aires will send the item to its New York correspondent for acceptance and ultimate collection. When the draft is re-

ceived in New York, it is presented to the National Bank of Commerce in New York and is accepted. The shipping documents are at that time detached and retained by the National Bank of Commerce and by them delivered to the American importer against his trust receipt. The National Bank of Commerce thus retains a lien on the goods pending the payment by the American importer to the National Bank of Commerce for the accepted draft. The accepted draft is either discounted by the presenting bank or held until maturity. The day before the maturity of the draft it is customary for the American importer to remit the funds to the accepting bank to cover the amount of the draft drawn under the letter of credit. Thus, when the draft is presented at the drawee bank funds are in readiness to take up the maturing draft and the whole transaction is completed.

The above transaction applies only to the "dollar" credits—those against which drafts may be drawn in United States dollars. However, commercial import credits are issued in any foreign currency. When so issued, a foreign bank is designated as the drawee of the drafts available under the credit and is advised of the establishment of the credit. When the drafts go forward for acceptance they are presented to the bank designated. The drafts are accepted by them and they forward to New York the documents covering the shipment. It is the general rule for foreign banks making the acceptance to require that funds be placed at their disposal for the retirement of the draft one full day before the maturity of the draft. It is thus the duty of the American bank to collect the amount of the draft from the importer in this country far enough in advance of the maturity date for the American banker to remit funds to the accepting bank to retire the draft.

EXPORT COMMERCIAL CREDIT DIVISION

The transactions of this division cover exports from this country. The operations are practically the reverse of

those described under the import credit division. A typical transaction would be somewhat as follows: A merchant in Norway desires to purchase leather from a dealer in Massachusetts. He will go to his banking connection and have them establish a credit for the Massachusetts exporter through the foreign department of the National Bank of Commerce in New York. The Norwegian bank advises the New York Bank of the opening of the credit, giving him such data as: (1) the amount of credit, (2) the name of the beneficiary, (3) the name of the importer in Norway, (4) the documents required as a security for the draft, (5) the time of shipment and (6) the expiration date of the credit.

The foreign department will then advise the Massachusetts leather dealer of the credit, its terms and conditions. When the shipment has been made, the exporter in this country will present his draft together with the required documents and, if everything is in order, the payment will be made. This virtually means that the exporter is paid for his goods before they leave his control, whereas, it was formerly the custom for foreign merchants to pay only on receipt of the goods by them.

COMMERCIAL LETTER OF CREDIT AUDITOR

All the work of the commercial credit division is carefully checked by a special auditor. Inasmuch as the department is acting solely as agents in these matters it is necessary to be absolutely certain that all credits are promptly and properly advised, that all changes in credit such as extension of time, changes in documents, changes in steamers are properly authenticated and duly advised to the beneficiaries, that all payments are made for full value received.

CREDIT AND LINE DIVISION

In connection with the purchase of bills of exchange and the issuance of letters of credit, it is necessary that files containing credit information concerning foreign banks, bankers, firms and individuals be maintained. This

U. S. Army or Navy Red Cross or Y. M. C. A.

Letters of Credit are the safest and most convenient medium for carrying funds.

During the war we are issuing such Credits, *free of commission*, to officers and men in the U. S. Army and Navy, and to those engaged in Red Cross or Y. M. C. A. work.

We have also sent our American representative to France for the convenience of our friends, with headquarters at the office of the Credit Commercial de France, 20 Rue Lafayette, Paris.

BROWN BROTHERS & CO.

Philadelphia

NEW YORK

Boston

BROWN, SHIPLEY & COMPANY

Founders Court, Lothbury
LONDON, E. C.

123 Pall Mall
LONDON, S. W.

credit information is also available to firms in this country desiring to do a foreign business.

When bills of exchange are submitted by American exporters to the foreign department for purchase, an "offering slip" is made up by the credit clerk. This slip gives an account of the present status of the customer's dealings with the bank. It is presented together with all available credit information concerning both the drawers and the drawees of the bills to an officer for his approval. After such credit risks have been passed on by duly authorized officers they are discounted or otherwise purchased by the bill of exchange division.

Similarly, before a letter of credit is issued, an "offering slip," the credit information on the applicant for the letter of credit and any possible information on the beneficiary of the letter of credit is handed to the duly authorized officer for his approval and after such approval, the letter of credit is issued.

A careful record of all the outstand-

ing bills of exchange purchased and letters of credit issued is also kept by this division for use in granting additional credit.

BUSINESS INVESTIGATION DIVISION

This division investigates the business and credit conditions in this as well as foreign countries, preparing information used in granting credits to firms in this country, etc.

THE MAILING DIVISIONS

All foreign mail and mail for the foreign department is received by this division each morning, and, after being opened, is distributed to the several divisions for which it is intended.

The mailing clerk in connection with the foreign exchange auditor receives and records the registered mail received, after which it is distributed to the various divisions.

All foreign outgoing mail is sealed, stamped and mailed by this division. A record is kept by the division of the sailings of the various vessels carrying

mail and duplicate mail is kept on file so that in the event of a steamer being sunk the duplicates are promptly forwarded.

FILING DIVISION

All correspondence relating to the foreign department is filed by this division.

TRANSLATING DIVISION

All letters received by the department written in foreign languages are translated into English. Although

nearly all of the outgoing mail from this department is in English, occasion arises where it is necessary to use a foreign language. The translation of these letters is also one of the duties of the division.

TELEPHONE EXCHANGE AND STENOGRAPHIC DIVISION

The department has its own telephone exchange and a corps of stenographers as well as dictaphone operators.



Business and Finance in Chile

The following statement regarding business and finance in Chile is from C. R. Edwards of the banking house of A. Edwards & Co., Valparaiso and Santiago, Chile. It is made available for publication through the courtesy of the Guaranty Trust Company of New York, to whom it was addressed.—Editor BANKERS MAGAZINE.

THE serious effects that followed the outbreak of the European War are no longer felt in Chile, and the great sources of national wealth have regained their former strength and activity.

With the gradual disappearance of the financial depression which existed during the first year of the war, with the increase in exports, and with the introduction of new capital from abroad by which important mining enterprises were encouraged, the equilibrium of the country has been reestablished and the financial situation is noticeably improved, particularly so far as foreign trade is concerned.

In 1916 the foreign trade of Chile reached a total of 736,105,572 gold pesos.* The imports were valued at 222,520,828 gold pesos and the exports at 513,584,744 gold pesos, leaving a trade balance of 291,063,916 gold pesos in favor of Chile.

Compared with the corresponding period of 1915, imports increased 68,309,271 gold pesos, and exports 186,105,586 gold pesos. It should be borne in mind that the amounts representing

imports were increased in 1916 because of new customs tariffs which went into effect March 1 of that year.

Before 1916 the values of imports were established according to rates announced at different times. At present the estimates are made according to prices on the invoices presented by merchants at the Custom House. These prices offer a more exact basis for statistics. Finally it should be noted that in general, the valuations indicated by customs reports are lower than general trade prices.

The values of the principal imports during 1916 are as follows:

	Gold pesos
Coal and petroleum	26,200,000
Live animals	4,500,00
Table oils	3,900,000
Vegetable food stuffs	9,300,000
Sugars	8,700,000
Cloth	30,800,000
Woven goods	6,200,000
Bagging	11,800,000
Garments and costumes	8,300,000
Industrial oils, etc.	10,800,000
Powder and explosives	5,100,000
Manufactured articles of iron and steel	11,100,000
Iron in bars and sheets	4,500,000
Industrial machinery	5,600,000
Mining machinery	3,100,000
Electrical supplies	2,900,000
Railroad supplies	4,200,000
Automobiles	4,300,000
Tanned hides and skins.....	3,600,000
Paper	7,100,000
Cement, etc.	3,100,000

*The gold peso to which frequent reference is made is the theoretical currency standard of Chile. Its value is approximately 36½ cents, U. S. gold. The value of the paper peso fluctuates, but in a U. S. Treasury circular dated July 1, 1917, its value is given as approximately 25 cents.

Classifying these imports according to the principal countries from which they come, gives the following values:

	Gold pesos
United States	94,400,000
Great Britain	54,700,000
Peru	15,300,000
India	12,400,000
Argentine Republic	6,800,000
Italy	4,800,000

The imports from Peru consist chiefly of sugars; those from India of jute bags, and those from the Argentine Republic of products of the grazing industry.

The export movement for 1916 was the largest for the 5-year period. It may be classified as follows:

	Gold pesos
Products of the mining industry.....	27,600,000
Products of manufacturing industries	84,400,000
Coin and precious metals.....	1,000,000

The official figures in regard to exports are not detailed but it is well known that the nitrate trade constitutes the principal element of national business; copper comes next; and agricultural products follow.

The destination of Chilean gold value of exports is classified as follows for the principal countries:

	Gold pesos
United States	252,400,000
Great Britain	133,000,000
France	38,600,000
Argentine Republic	14,000,000
Holland	6,600,000
Bolivia	5,200,000
Italy	5,200,000
Spain	4,300,000
Japan	3,800,000
Peru	3,600,000

Exports to the United States consist principally of nitrates, metals, and raw materials, both vegetable and animal. Nitrate of soda is much the most important product. Besides the articles mentioned, the exports to Great Britain, France, Holland, Italy, consist of agricultural products. Food products are sent to Argentina, Peru and Bolivia. Japan's imports consist principally of nitrates.



Advice to Investors

Purchase your securities through responsible dealers who have proper facilities for investigations and a reputation to maintain for reliable advice.

K. N. & K. are always posted on general market conditions, and their views are at the disposal of investors through their monthly review of

"The Investment Situation"
Write for pamphlet L-1

Knauth, Nachod & Kuhne

Members of New York Stock Exchange,

Equitable Building,
NEW YORK CITY.

Detailed statistics in regard to exports are lacking at present, but the figures for nitrates, which appear in official documents already published, may be given. The amounts and values of nitrates exported in the last three years are as follows:

Year	Metric quintals (=220 lbs.)	Gold pesos
1914	19,252,457	211,279,626
1915	19,910,940	213,647,009
1916	29,666,777	336,985,844

The principal nations which imported Chilean nitrates in 1916 are as follows:

Countries	Metric quintals (=220 lbs.)	Gold pesos
United States....	13,001,738	149,608,654
Great Britain ...	8,079,418	87,225,133
France	2,850,425	33,156,789
Russia	1,571,158	19,100,530
Holland	578,620	6,617,075
Italy	418,094	5,006,517
Spain	355,095	4,219,888

Remittances to U. S. Forces Abroad

Through the medium of our offices in London, Liverpool, Manchester and our agents in Paris, we will be pleased to undertake remittances to the American forces in Europe, both Naval and Military.

NEW YORK AGENCY
**BANK OF BRITISH
WEST AFRICA, LTD.**

6 WALL STREET

R. R. APPLEBY, AGENT

HEAD OFFICE . . . LONDON

In addition cargoes amounting to 983,017 metric quintals of 220 lbs., valued at 11,109,508 gold pesos were forwarded "to order."

The nitrate industry has increased during the present year, as is indicated by the latest statistics published by the Association of Producers. According to these figures, the production during the eleven months from July 1 to May 31 may be compared as follows:

Year	Spanish quintals (=101.4 lbs.)
1915-16	52,561,913
1916-17	57,858,211

For the present year the nitrate production already exceeds that for the corresponding period previous to the war and this unusual activity is reflected in the general economic situation of the country; it has promoted domestic busi-

ness, creating an increased demand for articles used by the great mass of workers in the country districts; it has increased the nation's capital, and has also contributed to the financial activity of the state, the most important basis for whose income is the export tax paid on nitrates.

In 1916 the export tax on nitrate of soda, iodine, and borax amounted to 102,031,502 gold pesos (of which 100,000,000 pesos of the tax was for nitrate alone) as against 68,268,659 gold pesos for the former year.

At the same time the custom tax on imports was 41,925,542 gold pesos in 1916 as against 27,236,234 gold pesos the previous year.

This increase in the public income has been general and has made it possible to meet the nation's expenses not only without compromising the credit of the state, as other countries have, under the circumstances, been forced to do, but by actually cancelling some part of the deficit, which in former years has marked the conduct of the finances of the nation.

The regular and extraordinary receipts for 1916 amounted to 237,765,261 paper pesos, and in the same currency the outlay amounted to 209,425,814 pesos. The receipts collected in gold amounted to 59,524,777 pesos, and the expenses, in the same currency, to 44,679,950 pesos.

This favorable situation has made it possible to reduce a part of the national deficit which formerly amounted to 9,121,911 paper pesos, plus 34,383,017 gold pesos.

In the present year the budget for receipts is estimated at 188,996,229 paper pesos and 47,162,773 gold pesos.

The budget for expenses voted by Congress was for 193,432,264 paper pesos and 69,635,281 gold pesos. However, as some of these expenses are met by special funds, the available budget, estimated according to the ordinary income, can be reckoned at 187,587,254 paper pesos and 47,172,281 gold pesos.

It should be noted, however, that there are expenses authorized by special laws which are not included in the

budget; these will increase the disbursements by a sum which has been reckoned by the President of the republic at 10,000,000 paper pesos and about 5,000,000 gold pesos.

In order to reduce the deficit it may be considered that in all probability there will be a greater income, in view of the increasing prosperity of business.

Both the present Administration and Congress have the definite intention of placing the republic upon a firm financial basis, of reestablishing the economic equilibrium by a campaign of severe

economy, and of contributing to the progress of the country through using those resources which are now beginning to be available for new taxes.

Thus, all financial and economic forces are contributing to improve the business situation which, at the outbreak of the European war was so depressing, and peace will find this country in circumstances which will permit it to take advantage of its great natural riches and which will give new importance to its great economic future.



The Bank of Japan

DURING the year 1916 this bank showed a net profit of yen 5,897,011. Total assets on December 31, 1916, were yen 1,078,867,575.

At the semi-annual meeting held on February 17, 1917, the Governor, Viscount Yataro Mishima, commented as follows on the economic condition of Japan:

"It was in the year before last that our foreign trade had begun to improve, and last year the benign effect of the situation was manifested still further both in the volume of trade and the excess of exports over imports as well as in the greater activity of our marine business which had been much improved in the previous year. Consequently payments due from abroad increased markedly, while the foreign exchanges remained constantly favorable to Japan, and this tended toward the inflow of specie and to a gradual increase in the specie holdings of our country both at home and abroad. Thus in the home market a conspicuous easiness was brought about, and in view of these circumstances the bank rate was reduced by two rin both in April and in July.

"Reviewing more particularly the financial situation in the country, we ob-

serve that in the market there was an abundant supply of money which was more than sufficient to satisfy the demands arising from the multiplication of various enterprises. As a consequence, the financial condition, which in the beginning of the year had been tending somewhat to tightness, began to grow easier about the early part of April. From that time forward easiness continued to prevail and idle money increased to such an extent that from August to September so great was the plethora that the list which opened on the 11th of September for the second series of the Treasury bills of the Rus-

Liberty Trust Company

8, Place Edouard VII.

Total Resources Over

\$10,000,000

PARIS - FRANCE



T. SATO
 Manager, Tokyo Branch the Bank of Chosen
 Mr. Sato has been recently in New York in the interests
 of his institution

sian Government to the amount of 70 million yen was closed on the same day, the applications received being for more than double the amount required. Until about the beginning of November the

same movement towards easiness continued, and in the market the lowest discount rates normally ruling were from 1 sen to 1.4 sen daily in Tokyo and from 0.8 sen to 1.4 sen in Osaka. It need hardly be said, however, that there were from time to time more or less fluctuations owing to the demand for money for the requirements of the season, the Stock Exchange settlement, and for other special purposes. But the general financial situation was unchanged, so that during the interval not a few plans of placing such securities as Debentures and municipal bonds were also carried out. As regards the price of commodities, though there was more or less fluctuation from month to month, the tendency of the movement was, in the main, upward. Over and above this, inasmuch as the export trade was active, the promotion of new companies and the extension of the old in such lines as spinning and other manufactures, electrical, mining and metallurgical, and shipping industries were undertaken in succession. This produced a rise in wages, while at the same time the increased profits yielded by various enterprises stimulated the activity of the Stock Exchange. Moreover, owing to the rise in the price of cocoons since the spring and a slight recovery of the price of rice from autumn to winter, the consuming power of the farming classes was enhanced. Such being the case, there were indications that the demand

COX & CO. (France) Ltd.

place their branches in France at the disposal of the Military and Naval forces of the United States, in Europe, for the remittance of funds and general banking business.

This bank was formed as a subsidiary of Cox & Co., founded in 1758, 16 Charing Cross, London, the official British Army Agents, for the convenience of the British Army in France.

Branches have been established with a British Staff at all the chief military bases, and agencies at
 Paris, Rouen, Havre, Boulogne, Amiens, Marseilles,

COX & CO., 16 Charing Cross, London,
 and

LONDON & SOUTH-WESTERN BANK, LTD.,
 170 Fenchurch Street, London.

who are the joint proprietors.

for money was gradually increasing; by the end of November the money market came to evince a certain briskness, and when December was reached a slight undertone of tightness was still perceptible. All of a sudden a cable message was received reporting the proposals of peace by Germany to the Allies. A flurry was produced on the Stock Exchange, but happily it passed away without doing much harm. So it came to pass that the demand for money for the purpose of settling the accounts at the end of the year was to a greater amount than usual, and the money market gave evidence of tightening. But after the Stock Exchange had calmed down, the year closed with a feeling of some easiness.

"Having thus outlined the financial and commercial situations, I shall now



T. KIRITA

Mr. Kirita is in the service of the Government General of Chosen, and is now in New York with the object of furthering trade relations between Japan and the United States.



HIROMA YASUDA

Manager Bank of Chosen, Seoul, Chosen

Mr. Yasuda is at present in New York with a view to extending the relations of his bank with the financial institutions of the United States.

point out a few features or facts in the finance of last year which demand attention. The first is that deposits, advances, and cash in hand at the banks of Tokyo and Osaka all showed a marked increase over those of the previous year, yet relatively to the deposits the advances and the cash rather tended to decrease, especially the last. The amount of cash sometimes did not reach even one-third of the amount in the corresponding period of the previous year, the decrease being in all probability due to the fact that a proportionately larger amount of money went into public loan bonds, debentures, shares, foreign securities, and the like. The second is that not only did the Government redeem foreign loans amounting to 108 million yen, but also among the public the Treasury bills of the Russian Government, the Ssu-cheng Railway loan,

NOYES & COMPANY

Established 1879

Foreign Bills
Government and Municipal Bonds

8, Place Edouard VII.
 PARIS - FRANCE

and the exchequer bonds in yen of the British Government were taken up or issued, and in addition to these, another batch of the Treasury bills of the Russian Government which had been taken up and held by the Government Deposit Bureau, was also absorbed, the total amount of these foreign government securities taken up or issued here being over 240 million yen; there being thus last year a complete reversal of what had been occurring for many years previously when it was quite the order of the day for foreign capital to be introduced and foreign loans issued. The third is that with the excess of exports, the accumulation of specie, the development of enterprises, and the expansion of businesses, the amount of notes issued by this bank also increased gradually until on December 30 it reached the enormous and unprecedented figure of 610,530,000 yen.

"Reviewing further the trend of our foreign trade, we find that, including the trade in the Chosen and Taiwan, exports aggregated 1, 173,000,000 yen and imports 793,000,000 yen, the total being about 1,966,000,000 yen. These figures, compared with those for the previous year, show an increase of 441,000,000 yen on the side of exports, and 230,000,000 yen on that of imports. Since the beginning of last year both exports and imports have steadily increased, but owing to the present cir-

cumstances the advance of the former has been most remarkable, for in every month since January they have outstripped the latter to such an extent that the aggregate excess of exports over imports for the year amounts to 380,000,000 yen. Now, if we seek for an explanation of these results, we shall find it in the fact that, in the case of imports, even though cotton, iron, machinery, etc., show generally considerable increases, the importation from European countries as a whole was still in a depressed state owing to the war; whereas, in the case of exports, staple articles in general showed a marked increase for instance, owing to the financial prosperity in America, there was such a boom in the raw silk market that the total export reached the value of 267,000,000 yen, and in the case of cotton yarns, though there was but a small decrease in quantity, a rather heavy increase in value was brought about, while cotton fabrics and cotton manufactured goods showed increases both in quantity and value.

"The main conditions of our foreign trade being such as I have described, the course of exchange on foreign countries was generally favorable to Japan. In the case of England, it rose from 2/1 3-16 to 2/1 9-16, while the exchange on France which had stood at 2.91½ at the beginning of the year, was ruling 2.96 at the end of the year, the highest quotation being 2.98½. The exchange on America rose gradually from \$49⅞, until it reached \$50.50. Thus, no small amount of specie flowed into the country. As for the exchange on China, the demand for subsidiary coins in the belligerent countries of Europe and in America, the demand in India for silver coin in increasing quantities, and other factors, all combined to bring about a sharp rise in the price of silver, so that the quotation that had been ruling at 82 taels in January, at last, fell to so low a figure as 59 taels. While at the same time, the rise in the price of silver at Shanghai was rather less than that in London, so that no small amount of specie was exported from this country to China. Neverthe-

THE BANK OF CHOSEN

Incorporated by Special Charter of Imperial Japanese Government

(¥0.50 — 1 Yen)

Subscribed Capital, Yen 20,000,000

Paid-Up Capital, Yen 12,500,000

Head Office, Seoul, Korea

Principal Branches:

KOREA: Chemulpo, Pyongyang, Wonsan, Fusan

MANCHURIA: Mukden, Dairen, Changchun, Newchwang, Harbin, Antung

JAPAN: Tokyo, Osaka, Kobe

Affiliated Bank:

VLADIVOSTOK: Matsuda Bank

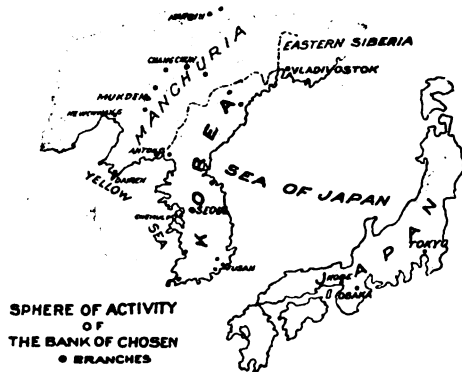

Principal American Correspondents:

Guaranty Trust Company of New York
Irving National Bank, New York
National City Bank of New York
National Bank of Commerce in New York

Yokohama Specie Bank, New York and San Francisco
Canadian Bank of Commerce, San Francisco

less the import of gold coin and bullion came to show an excess to the amount of 77 million yen.

"On the whole throughout last year there was continued improvement in financial and commercial conditions, as I have described, and I may add that in economic circles in general there were indications of progress. While the chief cause that has brought about this improvement has of course been the war, it must be recognized that a cause that contributed to it in no small degree is to be found in the joint endeavors of Government and people to increase the national strength. The termination of the war is, however, hard to foresee. Moreover, not only neutral countries as might be expected, but also the belligerent countries, seem to be leaving nothing undone in their strenuous preparations for reconstruction after the war. In these circumstances, if our country is to maintain her onward march in strength and to continue to augment her wealth, we must keep a careful

watch on the economic policy of the Powers and be ready to determine what measures to adopt, while we must see to it that the demand for capital and the supply of it shall be so well adjusted as to insure a steady and healthy development of all industries. To these points, gentlemen, I purpose to give particular attention in conducting the affairs of this institution, and I have pleasure in conveying to you this assurance."



Bank of New South Wales

AT the half-yearly general meeting of the proprietors of the Bank of New South Wales, held at the chief banking-house in Sydney, May 29, the half-yearly report (as of March 31) was presented. This report marked the completion of the bank's first centenary, and virtually the centenary of Australian banking as well. It had been the

BANKAKTIEBOLAGET SÖDRA SVERIGE

Head Office: HELSINGBORG, Sweden

Branches: STOCKHOLM, GOTHENBURG, MALMÖ, BORÅS and in 48 other
Places in Sweden

Capital Paid Up Kr. 30,000,000
Surplus About Kr. 15,000,000
Resources About Kr. 260,000,000

(\$0.26 = 1 Kr.)

The organization and excellent relations of this Bank secure to its clients the most efficient handling of their business on moderate terms

Inquiries and applications for terms are cordially invited and will find prompt attention

Principal New York Correspondents { The Mechanics & Metals National Bank
The National City Bank of New York

expectation to prepare for commemorating this event by beginning the erection of a building for the head office that would fittingly symbolize the very important position attained in Australasian banking by the Bank of New South Wales. But on account of the war, it was deemed prudent to postpone the erection of the new building.

The report for the last half-year showed net profits of £279,050, to which was added the balance brought forward from previous half-year, making a total of £384,292. After deducting an interim dividend of ten per cent. and paying a quarterly dividend at the same rate on March 31, £75,000 was added to the reserve, leaving £114,827 to be carried forward.

The paid-up capital of the Bank of New South Wales is £3,894,980 and the reserve £2,800,000. Deposits at the date of the last half-yearly report were £40,699,909, and the total of the balance-sheet £57,426,009. Hon. C. K. Mackellar is president, and J. Russell French, general manager. The latter has been in the service of the bank for about fifty-five years, and has been general manager for some twenty-three years. During the time he has been in the chief executive position the assets of the bank have grown from £24,000,000 to the high figure above recorded. As a banker and an economist Mr. French deservedly occupies a very high rank in his country.

A notable feature of the most recent half-yearly report of the Bank of New South Wales is the roll of honor, con-

taining the names of fifty officers who have given their lives in the service of their country. The staff of the bank is represented in the military forces by an enlistment of 634 of its members.



Report of La Banque Nationale, Quebec

FOR the year ending April 30, 1917, this bank showed net profits, after deduction for accrued interest on deposits and provision for bad and doubtful debts, of \$417,622.58. Out of this dividends at the rate of eight per cent. per annum (i. e., two per cent. payable August 1, November 2, February 1 and May 1) were paid, amounting to \$160,000; \$100,000 was appropriated to reserve fund; \$75,000 to depreciation on securities and for contingencies; \$50,000 to pension fund; \$20,000 to war tax on circulation; \$7,500 to patriotic fund. A balance of \$59,965.83 was carried to credit of profit and loss.

The reserve fund of the bank is now \$2,000,000, or equal to the capital. In 1895 there was no reserve. Deposits which at that time amounted to \$2,382,167 have now increased to \$27,618,301. Loans have increased from \$3,290,851 to \$29,635,999; assets from \$4,467,812 to \$36,596,248.

Deposits increased \$5,408,338 over last year, or nearly twenty-three per cent.

Redmond & Co.

33 Pine Street

New York

Oriental Exchange Business

We make arrangements whereby Banks and Bankers can issue as principals their own drafts against our account with the Russo-Asiatic Bank, Hongkong, and branches in China and Japan.

Correspondence is invited

High Grade Investment Securities

Members of the New York Stock Exchange

Unprecedented Imports of Gold in 1917

THE total movement of gold and silver between the United States and foreign countries during the fiscal year 1917 reached the unprecedented total of \$1,382,380,745. According to a statement issued by the Bureau of Foreign and Domestic Commerce, Department of Commerce, the imports of gold were \$977,176,026 and of silver \$35,003,563. Gold exports amounted to \$291,921,225 and silver exports to \$78,279,931.

The net imports of gold during the fiscal year aggregated \$685,254,801, a striking increase over the net import of \$403,759,753 in 1916 \$25,344,607 in 1915, and the net export of \$45,499,870 in 1914.

The net exports of silver showed an increase in 1917, but this metal is produced in great quantities in this country and is sold abroad in the same manner as other commodities. An excess of exports, therefore, has no such sig-

nificance as is sometimes attributed to a similar movement in gold.

In addition to the imports of gold and silver from foreign countries domestic gold amounting to \$15,409,529 and silver amounting to \$683,824 were shipped from Alaska to the United States during the year.



Barclays Bank, Limited

THE board of Directors of Barclays Bank, Limited, have declared out of the profits of the half-year ended June 30, an interim dividend of four shillings per share on the "A" shares, seven shillings per share on the "B" shares of sixteen pounds each (four pounds paid), and one shilling and nine pence per share on the "B" shares of four pounds each (one pound paid) being at the rate of ten per cent. per annum on the "A" shares, and seven-teen and one-half per cent. per annum

on the "B" shares, subject in each case to deduction of income tax.

This bank has a subscribed capital of £12,679,440 in 474,861 "A" shares of £4 each, fully paid, 450,000 "B" shares of £16 each, £4 paid, and 894,999 "B" shares of £4 each, £1 paid. It has total assets of £113,661,385.



Publishes Iron and Steel Catalogue

THE English edition of the new 94-page iron and steel catalogue of the American Steel Export Company is now ready for foreign distribution. The Spanish, French, Portuguese, Italian and Russian editions are to be published shortly, now being in process of preparation.

This catalogue contains much information, such as weights, and measures in English and metric tables, and data covering such products as pig iron, billets, blooms, slabs and sheet bars, plates and shapes, tool steel, merchant bars and agricultural steel, wire products, pipe and tubing, rails and railway supplies, castings and forgings, sheet and tin plate, etc.

The object of this catalogue is to inform overseas buyers concerning American sizes, weights, etc., and the booklet also includes specifications covering tolerances and other valuable data.



Standard Bank of South Africa

FROM a cable message recently sent to W. H. Macintyre, New York agent of the Standard Bank of South Africa, it is learned that, subject to audit, the directors have declared an interim dividend at the rate of fourteen per cent. per annum, less income tax. The bank's investments stand in the books at less than market value at 30th of June last, and all other usual and

necessary provisions have been made.

For some time the New York Agency of the Standard Bank of South Africa has been located at 55 Wall Street, but in the first week of September removal was made into new quarters at 68 Wall Street.



New Mexican Banking Company

THE American consul general at Mexico City has sent the following telegram:

"Congress chambers of commerce completed arrangements for the formation of private banking company and branches of 'Compania Hancaria Comercial Mexicana.' Capital \$1,000,000, American currency, subscribed 10 per cent. monthly; single holding limited to 250 shares of \$10; object to secure members means of exchange."



London City and Midland Bank

THE last statement of the London City and Midland Bank with head offices in London is as of June 30, 1917, and as compared with the statement of the same period in 1916 shows fine progress. Total assets are £196,715,021 which is a gain of £22,835,332, while deposits amount to £180,417,249. A dividend was declared for the half year at the rate of eighteen per cent. per year and a bonus of £100,000 was voted for the staff. Arrangements have been completed whereby the Belfast Banking Company will merge with this institution.



Lloyds Bank, Limited

WTH a paid-up capital of £5,008,672 and a reserve fund of £3,600,000, Lloyds Bank, Limited, with

The Union Bank of Manchester, Limited

Head Office
17 York St., Manchester, Eng.

Liverpool Office
45 Castle St., Liverpool, Eng.

and branches covering the whole of the district tributary to these two cities, and also WEST YORKSHIRE; including SHEFFIELD, BRADFORD, SALFORD, BIRKEN-HEAD, OLDHAM, BOLTON, BURY, ROCHDALE, STOCKPORT, HALIFAX (ENG.), HUDDERSFIELD, etc., etc.

	($\$5 = \pounds$)
Nominal Capital	\$12,500,000
Paid-up Capital	2,750,000
Reserve Capital	3,500,000
Subscribed Capital	6,250,000
Reserves	1,903,470
Surplus over Liabilities	8,153,470

Bankers in the United States and Canada are invited to make use of the Bank's services for all kinds of banking business in the district where the Bank operates, and in Great Britain generally. Collections promptly dealt with, and proceeds remitted by draft or cable transfer on New York, or as desired. Favourable terms.

head offices in London, in its statement as of December 31, 1916, shows total resources of £171,632,486. Deposits amount to £151,368,306. The profit and loss account for the year balances at £1,390,766. Net profits for the year after making provision for rebate, etc., amounts to £1,283,797. A dividend has been paid at the rate of $18\frac{1}{8}$ per cent. per annum less income tax.



Statement of Bank of Liverpool, Limited

THE last statement of the Bank of Liverpool, Limited (June 30, 1917), with head offices in Liverpool, shows total resources of £46,592,830 and deposits of £43,717,717. Gross profits for the year after bad and doubtful debts have been cared for amount to £814,003. The profit and loss account balances at £916,885 with the 170th dividend payable July, 1917,

amounting to £138,711. The bank has a subscribed capital of £13,871,120.



National Banks in Foreign Countries

IN the course of a very thoughtful article on "United States Banking," in the issue of August 4, "The Statist" of London, referring to the Federal Reserve System, makes no prediction as to the future of the system, but thinks the careful attention of British bankers. development of our banking worthy of It says:

"We hold that it is of the highest interest that all British bankers should make themselves as thoroughly acquainted with the new American system as circumstances will permit, and should watch closely and continuously how the new system works in practice. Up to the present it has had only fair sailing.

Now it is entering upon a great mass of new business. And how it conducts the new business will affect not only the prosperity of the American banks themselves, and even of the American people, but the prosperity, likewise, of Europe. Meanwhile, we need only add as introductory to what we hope to say in future issues, that the national banks, which are the banks which do business directly with the public, are now authorized to open branches, not in the United States alone, but in foreign countries likewise. And, therefore, the national banks will henceforth do an active, and we do not doubt, an increasingly large business throughout Europe."

Bank of the Philippine Islands

THE report of this institution for June 30, 1917, appears herewith:

RESOURCES

	Pesos.
Cash	3,054,578
Investments	741,010
Loans and discounts.....	16,606,508
Correspondents	3,228,252
Other assets	1,561,974
Securities deposited	384,480
Total	25,576,802

LIABILITIES

Capital	4,500,000
Reserve funds	1,625,000
Deposits and current ac- counts	10,354,499
Notes in circulation.....	5,535,700
Profit and loss	315,293
Correspondents	1,184,964
Other liabilities	1,676,866
Deposits for safe custody..	384,480
Total	25,576,802

Manila is the head office of the bank, while branches are maintained at Iloilo and Zamboanga. Officers of the bank are: President, John S. Hord; vice-president, Eliseo Sendres; secretary, C. G. Clifford; assistant secretary, Rafael Moreno; cashier, D. Gar-

cia; accountant, F. Borromeo; chief of foreign department, O. M. Shuman; chief department of securities, D. A. Jumper.

Redemption of Japanese Debt

OWING to the strong financial position of Japan, the present is an opportune time for redeeming a portion of the outstanding debt in advance of maturity. Recently the announcement was made that a purchase of £178,500 four and one-half per cents. sterling bonds of the first series and £104,360 of four and one-half per cents. of the second series would be bought for cancellation.

Since 1909 Japan has been devoting annually 50,000,000 yen to debt redemption.

English Banks in War Times

ANALYZING the figures published by nineteen English banks, "The Economist" finds that from June 30, 1914, to June 30, 1917, there have been the following changes, the figures representing pounds sterling:

LIABILITIES

	Millions
Capital and reserves....	Increase 3
Deposits, etc	" 321
Total	" 324

ASSETS

	Millions
Cash in hand and at Bank of England	Increase 77
Investments	" 164
Loans and discounts.....	" 88
Total	" 324

Commenting on these figures, "The Economist" says:

"The full figures will be given in our autumnal banking number, and at present we need only point out that inflation through bank credits is seen to have proceeded more slowly, and by a

MERCANTILE BANKING COMPANY, Ltd.

Avenida Francisco I. Madero No. 12

CITY OF MEXICO, D. F.

Capital and Surplus, \$600,000.00

GEO. J. McCARTY, President K. M. VAN ZANDT, Jr., Vice-President and Manager H. C. HEAD, Cashier FCO. COUDURIER, Asst. Cashier

Members: American Bankers' Association, Texas Bankers' Association, Mexico City Clearing House

GENERAL BANKING TRANSACTED TELEGRAPHIC TRANSFERS

Foreign Exchange Unsurpassed Collection Facilities Throughout the Republic

SEND US YOUR MEXICO BUSINESS

WRITE US UPON ANY SUBJECT WHICH MAY BE OF INTEREST TO YOU IN THE
REPUBLIC OF MEXICO. P. O. Address: Apartado 1348.

different method, in the past year as compared with the whole period, the investments of the banks having been reduced during its course, while the loans and discounts have expanded with great rapidity. Both these movements may probably be attributed to the effect of the great War Loan of last January. To enable their customers to subscribe, we know that the banks made large advances to them, of which only a small part had been repaid at the end of June."



Spanish Bank of Agricultural Credit

PRELIMINARY steps have been taken for creating in Spain a National Bank of Agricultural Credit, the central office of which will have a capital of ten million pesetas, the State to subscribe three millions of this amount. The remaining two millions will be placed at the disposal of the free banks and agrarian associations, that must subscribe to a minimum of 100,000 pesetas each to be on the committee. The unsubscribed surplus will be offered to the Spanish Mortgage Bank.



London Joint Stock Bank, Limited

WITH head office in London the London Joint Stock Bank, Limited, in its statement of condition as of June 30, 1917, shows total resources

of £54,827,346. The bank has a paid-up capital of £2,970,000 and a reserve fund of £1,125,000. A dividend for the half year has been declared at the rate of ten per cent. per annum, equal to 15s. per share, payable less income.



Union Bank of Manchester, Limited

ESTABLISHED in May, 1836, and with a capital paid-up of £550,000 the Union Bank of Manchester, with head offices in Manchester, in its last statement as of June 30, 1917, shows total resources of £10,766,130. Deposits amount to £8,618,133. The profits for the half year after deducting rebates, etc., amount to £138,256 and the profit and loss account balances at £107,025. The dividend payable in July was at the rate of £1 per share.



South American Trade

TRADER of the United States with South America in the fiscal year just ended as shown by the National City Bank will aggregate nearly \$800,000,000, against less than \$400,000,000 in any year prior to the war. The total trade with that continent in the ten months, for which a complete record is now at hand, is \$632,000,000, and for the latest month (April) of that period, \$79,000,000.

Bank of Guatemala

THE statement of the Bank of Guatemala as of June 30, 1917, shows total resources of \$98,534,534.19 and a paid-in capital of \$2,500,000. The bank has a reserve of \$9,602,728.33 and notes in circulation amount to \$61,060,731.



Hibernian Bank, Limited

AS of June 30, 1917, the Hibernian Bank, Limited, with head offices in Dublin shows total resources of £5,995,976, with deposits of £5,288,522. The profit and loss account for the half year ended June 30, balances at £73,857 and the gross profit after providing for interest, etc., amounts to £64,478. The

bank has a subscribed capital of £2,000,000.



Banco Agricola Comercial

AS of June 30, 1917, the Banco Agricola Comercial of the Republic of Salvador shows total resources of \$4,013,672.06. The bank has a capital paid in of \$1,300,000 and a note circulation of \$1,816,077. It was founded in 1895.



Announce New Director

ERNESTO Tornquist & Co., of Buenos Aires, have announced the election of Ernesto Pasman as a director of the company.



Women as Bank Employees

FROM the viewpoint of a Philadelphia banker, as reported by the "Public Ledger," women do not stay with their jobs long enough to make desirable bank clerks. Here is the way he regards women as bank employees:

"A bank clerk can't saw off his work into lengths. He has to stay till his work is done. If there's an error he has to run it down. In times of pressure he's got to go without food or sleep for long periods.

"This bank has recently employed a number of girls to fill the places of men. It is one of several banks that do so.

"The girls have been an emphatic failure. I've read a lot of bunk in the

papers lately about young women being fully equal to the male clerks. But if I get one in five that makes good I think I'm lucky.

"They come here to work on the way to matrimony. They don't care anything about the work; they have no professional pride. When quitting time comes they want to go home, whether they're through or not. Only yesterday a girl kept a customer off the line for fifteen minutes while she talked to her best young man.

"If you remonstrate with 'em, they don't take it the way a man would. They get angry or they cry.

"I'm not a pessimist. I love the ladies, God bless 'em! But they're meant to be loved, not to be worked."

Book Reviews

MODERN CURRENCY REFORMS. By E. W. Kemmerer. New York. Macmillan Co. Price, \$2.40.

A careful study of five recent currency reforms, those of the Philippines, Porto Rico, India, Straits Settlements, and Mexico. In each case the treatment covers conditions preceding the reform, causes, plan of reform and results.

The volume throws light on fundamental monetary principles and will afford lessons of value to countries undertaking a thorough reform of their currency system.



WHAT EVERY BUSINESS MAN SHOULD KNOW. By L. C. Kearney. Frederick A. Stokes Company. New York. Price, \$1.60.

Assembles in one volume the usually scattered information to which the hurried business man frequently has occasion to refer.

The best contemporary authorities were consulted in an effort to present the most reliable data obtainable on each subject under consideration. As a reference book on industry or commerce it is authoritative and up-to-date.



PANAMA CANAL AND COMMERCE. By Emory R. Johnson. New York. D. Appleton & Co. Price, \$2.00.

A book for those who would know why the Panama Canal was built; and who would understand the enormous value of this unique waterway, its commercial history, the tonnage and tolls, the types of ships, routes, rate zones, etc.

The volume presents a vast amount of information to exporters, importers, and to the reader in general.

HOW TO INVEST MONEY. By George Garr Henry. Funk, Wagnalls Co. Price, \$0.75.

This volume presents for the average reader the simple principles of investment.

Discusses in detail railroad mortgage and equipment bonds, real estate and public utility bonds. Stocks, and the market movements of stocks in general.



DELBRIDGE WONDERFUL INTEREST TABLES, 1-96 DAYS. By C. L. Delbridge, Delbridge Co., St. Louis. Price, \$5.00.

This form of interest calculator has been issued at the request of many bankers who want a book with the various rates on one page.

This shows the interest on every sum from one dollar to one hundred thousand dollars at the following rates of interest: $\frac{1}{8}$, $\frac{1}{4}$, $\frac{1}{2}$, 1, $1\frac{1}{2}$, 2, $2\frac{1}{2}$, etc., up to eight per cent; at ten per cent and at twelve per cent. Also contains time tables and perpetual due date indicators.



EXPORTING TO LATIN AMERICA. By Ernst B. Filsinger. New York. D. Appleton & Co. Price, \$3.00.

This volume is written from the business man's standpoint and everything not thoroughly practical has been omitted.

This clear and systematic presentation of the conditions necessary to the development of foreign trade means a service which will be appreciated by commercial travelers, students of export problems, government officials, officers of export associations and many others in addition to the merchants, manufacturers and financiers who are materially interested in its development.

PITFALLS OF SPECULATION. By Thomas Gibson. The Moody Magazine and Book Publishing Co. New York. Price, \$1.00.

"Pitfalls of Speculation" as published ten years ago has been amplified and brought up to date, rather than revised.

This volume suggests how the novice may intelligently determine when general basic conditions and future prospects are sufficiently promising to warrant a speculative venture.

A chapter is devoted to the interpreting of railroad and industrial reports.

CORPORATION FINANCE, Part II. By Hastings Lyon. New York. Houghton Mifflin Co. Price, \$2.00.

Discusses the distribution of corporate securities and the financial side of reorganization and recapitalization. Details in full the principles governing the issuance and sale of stocks.

Part I, "Capitalization," was published some years ago, and the favor with which it was received suggested the publication of a work covering more generally the field of corporation finance.



Reproduced through the courtesy of "The New York Tribune"

Canada's System of Paying Overseas Troops

By H. M. P. ECKHARDT

IN view of the prospective large increase in numbers of United States troops stationed in Europe, Canadian bankers have been comparing the exchange problems developing therefrom with the problems of the same nature which Canada has been obliged to handle since 1914.

An article published by the "Journal of Commerce" on July 19 intimated that the American troops in France would probably be given the option of taking their pay in French currency or in funds payable in the United States. Canada's experience is that in case of a very large number of the private soldiers and petty officers serving abroad, circumstances are such as to demand that a considerable part of the soldier's pay shall go to his dependents at home. An arrangement under which the Canadian Government provided for full payment of men in the field while the individual soldiers sent back to Canada the portion of pay required by their families, appeared to be unnecessarily complicated. So the Government required the soldier, before his departure for Europe, to assign so much of his monthly pay to his Canadian dependents—say \$15 or \$20 per month. Then each month the Militia Department at Ottawa sends out to these parties in the several provinces of the Dominion its own checks for the amounts assigned. The balance or unassigned part of his pay the soldier may draw in cash—in French or English currency—the payments being made by the British authorities on behalf of and at debit of Canada.

As the Canadian infantry private's pay is \$1.10 per day, it will be seen that he assigns roundly from one-half to two-thirds of his pay. Of course, while he is in the trenches he does not

have much opportunity of spending money; but when his regiment is relieved he usually wishes to indulge to a certain extent, and the soldiers as a rule spend a certain amount of their pay for provisions, etc., to supplement the army rations and for extra items of clothing, etc., which tend to keep them healthy and comfortable.

In addition to the assigned pay, the Ottawa Government sends out each month to the soldier's wife another check of \$20, covering what is termed the "separation allowance." Then, entirely apart from the payments by the Government is the patriotic fund. This is raised and administered by citizens. Its purpose is to make further monthly grants to dependents of soldiers on active service—the amount of the monthly check being based on the size of the family and number of young children.

When the United States completes its war organization perhaps some of these methods adopted by Canada will be shaped to suit American needs. Notwithstanding all possible care in applying the draft law there will be a vast number of cases where a considerable part of the American soldier's pay will have to go to his family, and it does not seem advisable to send the money to France (or arrange for its payment there) and involve the soldiers or the army executive in the trouble and work of sending it back again. This matter could be covered by assignment and the issue of Treasury checks as in Canada's case.

The establishment of an American patriotic fund on the same lines as Canada's fund would involve extensive organization work similar to that now working in connection with the Red Cross Fund.

Japanese Commission to America

FOR the purpose of considering matters of joint interest to Japan and the United States, an Imperial Japanese Commission is now in this country. This commission is headed by Viscount K. Ishii as Ambassador Extraordinary and Plenipotentiary. On being welcomed at a Pacific coast port of the United States on August 14, Viscount Ishii made this eloquent reply:

"We come to you at the dawning of a new day. As individuals we have no right to expect to find place at this busy time of preparation. But we come as the humble representatives of the gracious Sovereign of a friendly and loyal nation, and we say that we know well that performance, not profession, deeds not words, sacrifices not selfishness, are the requisites of the hour.

A COMMON GOAL

"Our message is that in this day, through its hours of shadow or of sunshine, your purpose is our purpose, your road our road, and your goal our goal. It is that America and Japan will march together, work together, and fight together as comrades until the end has been reached and the victory won in the struggle which involves our rights and our liberties.

"It is for that—and I take the liberty of using the thought of your great President, Abraham Lincoln—in order that each of us may enjoy an open field and a fair chance for our industry, enterprise, and intelligence that the struggle must be maintained; that we may not lose our birthright—the right of humanity.

"We are here to say that in this tremendous struggle for those rights and liberties, America and Japan are bound together; that when the victory of the allied forces is secure, America and Japan should so live that your sons and our sons will have a certainty of good

neighborhood; so live that no word or deed of either can be looked upon with suspicion; that venomous gossip, hired slander, sinister intrigue and influence, of which we have both been the victims, can in future only serve to bring us closer together for mutual protection and for the common welfare.

WILL SAFEGUARD THE PACIFIC

"The importance of this coöperation was brought home to us particularly as we voyaged safely and pleasantly across the Pacific Ocean. We must indeed have assurance of good order in our neighborhood. We cannot, either of us, take risks. It becomes the first duty of Japan and America to guard the Pacific and to insure safe, continuous intercourse between Asia and the United States, to see to it that the ships of the ferocious pirates whose crimes upon the high seas can never be palliated find no shelter in the waters of our seas.

"It is for us together to continue to enforce respect for law and humanity upon the Pacific, from which the German menace was removed at the commencement of the war. Had this not been so, had the barbarian of Europe not been rooted from his Oriental bases, the shuddering horrors of the Atlantic and the Mediterranean would to-day be a grim reality on the Pacific. In the protection of our sea-going merchandise and men, in safeguarding the pleasures of intercourse, you may count on us as we must count on you.

JAPAN AND UNITED STATES AS PARTNERS

"In the dawning of this new day of stress and strain, let us forget the little mole hills that have been exaggerated into mountains to bar our good relations. Let us see together with a clearer vision the pitfalls dug by a cunning enemy in our path, let us together fix our eyes upon the star of principle

which shall lead us together most surely to a participation in the triumph of the right, to a certain victory in the greatest and, let us hope, the last great war in human history.

"And when that victory shall have been won, let us together help in the upbuilding of a new world, which shall rise, fair and strong and beautiful, from the ashes of the old."

Bank Advertising Exchange

Those listed herewith are willing to exchange booklets, folders and other advertising matter issued by them. Subscribers can get on this list free of charge

Watch for New Names and Other Changes

A

Adams, F. R., Will County National Bank, Joliet, Ill.
 American National Bank, Richmond, Va.
 Ansley, D., c/o Central Trust Co., San Antonio, Tex.
 Art, Carl W., manager publicity department, Union Trust Co., Spokane, Wash.

B

Bader, A. F., publicity manager, Old State National Bank, Evansville, Ind.
 Balley, C. W., cashier, Southern Trust Co., Clarksville, Tenn.
 Bank of San Rafael, San Rafael, Cal.
 Bankers Magazine, The, New York.
 Bauder, Ray E., cashier, First National Bank, Taylorville, Ill.
 Baugher, E. M., president, The Home Building Association Co., Newark, O.
 Beerbower, C. W., National Exchange Bank, Roanoke, Va.
 Bollman, H. C., assistant cashier, First National Bank, Collinsville, Okla.
 Branham, D. R., 6252 Leland Way, Los Angeles, Cal.
 Brannen, Jesse E., cashier, First National Bank, Westwood, N. J.
 Brooks, T. J., cashier, The Guaranty Trust and Savings Bank, Jacksonville, Fla.
 Brown, R. A., assistant cashier, Citizens National Bank, Raleigh, N. C.
 Bunch, F. B., cashier, Merchants and Farmers Bank, Statesville, N. C.
 Burton, E. C., vice-president, Penn. National Bank, Chester, Pa.
 Burwell, Stephen L., vice-president, First National Bank, Jackson, Miss.
 Bush, A., Jr., Ladd & Bush, bankers, Salem, Ore.

C

Citizens Bank and Trust Co., Tampa, Fla.
 Citizens National Bank, Oconto, Wis.
 Commercial Bank, Midway, Ken.
 Copp, H. Reed, assistant advertising manager, National City Bank, New York City.
 Cory, Arthur S., Chehalis National Bank, Chehalis, Wash.
 Craig, David, Tradesmen's National Bank, Philadelphia, Pa.
 Critchell, L. S., publicity manager, Guaranty Trust Co., New York City.
 Crowson, M. Clarence, cashier, Home Banking Co., High Point, N. C.
 Culbreth, Eugene E., Commercial National Bank, Raleigh, N. C.

Currey, Bradley, c/o Fourth and First National Bank, Nashville, Tenn.

D

Dalby, H. A., Naugatuck Savings Bank, Naugatuck, Conn.
 Davenport, C. M., manager new business department, Bank of Italy, Los Angeles, Cal.
 Dexter Horton National Bank, Seattle, Wash.
 Durham, T. R., assistant cashier, Chattanooga Savings Bank, Chattanooga, Tenn.
 Dysart, W. R., assistant cashier, First National Bank, Ripon, Wis.

E

Eberspacher, J. C., assistant cashier, First National Bank, Shelbyville, Ill.
 Eklirch, A. A., secretary, North Side Savings Bank, New York City.
 Ellsworth, F. W., secretary, Guaranty Trust Co., New York City.

F

Finch, E. W., assistant cashier, Birmingham Trust and Savings Co., Birmingham, Ala.
 First National Bank, Lead, S. D.
 Franklin Society, 38 Park Row, New York City.
 Frieden, Ben W., 334 Davidson Building, Sioux City, Iowa.

G

German-American Bank, Springfield, Mo.
 Gooden, B. P., Mercantile Bank of the Americas, New York City.
 Groves, J. W., advertising manager, Northwestern National Bank, Minneapolis, Minn.

H

Hamsher, C. F., First National Bank, Los Gatos, Cal.
 Hann, Victor F., manager publicity department, The Fifth Avenue Bank, New York City.
 Hardee, D. L., publicity manager, Wachovia Bank and Trust Co., Winston-Salem, N. C.
 Harper, W. A., Lumberman's National Bank, Houston, Tex.
 Hatton, E. A., cashier, First National Bank, Del Rio, Tex.
 Hill, John R., Barnett National Bank, Jacksonville, Fla.
 Hoagland, Jessamine G., publicity manager, National City Bank, Chicago, Ill.
 Hokanson, N. M., State Bank of Chicago, Chicago, Ill.

J

Jarvis, Charles D., c/o Savings Bank of Utica, Utica, N. Y.

Jenkins, W. L., Farmers and Mechanics Trust Co., West Chester, Pa.
 Jessup, Theodore, Woodlawn Trust and Savings Bank, 1204 E. 63rd Street, Chicago, Ill.
 Jones, W. P., assistant cashier, First National Bank of Commerce, Hattiesburg, Miss.

K

Kahn, A. T., vice-president, Commercial National Bank, Shreveport, La.
 Kankakee County Trust and Savings Bank, Kankakee, Ill.
 Kay, W. R., Jr., advertising manager, Sacramento Bank, Sacramento, Cal.
 Keller, C. B., Jr., assistant cashier, Stroudsburg National Bank, Stroudsburg, Pa.
 Keyton, Grover, New Farley National Bank, Montgomery, Ala.

L

Lanier, B. W., First National Bank, Lakeland, Fla.
 Lindhjem, A. E., assistant cashier, Scandinavian-American National Bank, Minneapolis, Minn.
 Logan, John, cashier, Columbus State Bank, Columbus, Mont.

M

McDowell, J. H., c/o American Trust and Banking Co., Chattanooga, Tenn.
 Mann, Ralph H., Park Trust Co., Worcester, Mass.
 Marvel, Charles S., The First-Second Savings and Trust Co., Akron, O.
 Matthews, Dave S., assistant cashier, Farmers and Merchants Bank, Stockton, Cal.
 Matthews, H. B., S. W. Straus & Co., Straus Building, Chicago, Ill.
 Merrill, Frank, advertising manager, The Northwestern National Bank, Minneapolis, Minn.
 Meyer, A. J., Union Trust Co., Rochester, N. Y.
 Mills, W. C., New Business Department, Metropolitan Trust Co., 60 Wall Street, New York City.
 Muirhead, G. C., vice-president, The Stock Growers State Bank, Worland, Wyo.

N

Northwestern Trust Co., R. P. Sherer, vice-president, St. Paul, Minn.
 Norton, W. W., treasurer, Robbins Burrall Trust Co., Lakeville, Conn.

O

Old State National Bank, Evansville, Ind.
 Overton, J. A., cashier, The National Bank of Smithtown Branch, Smithtown Branch, N. Y.

P

Parish, R. B., cashier, Bluefield Bank, Bluefield, W. Va.
 Poole, John, president, Federal National Bank, Washington, D. C.

Potter, A. E., president, Broadway National Bank, Nashville, Tenn.
 Potts, W. W., treasurer, The Federal Title and Trust Co., Beaver Falls, Pa.
 Publicity Department, St. Louis Union Bank, St. Louis, Mo.

R

Ruff, William J., cashier, Luzerne County National Bank, Wilkes-Barre, Pa.
 Russell, W. W., cashier, First National Bank, White River Junction, Vt.

S

Schlenker, Almot, assistant cashier, First National Bank, Brenham, Tex.
 Schulze, Paul T., assistant cashier, State Bank of La Crosse, La Crosse, Wis.
 Scott, Walker, vice-president, Virginia Trust Co., Richmond, Va.
 Shepherd, George W., c/o International Trust Co., Boston, Mass.
 Smith, A. C., vice-president, City National Bank, Clinton, Iowa.
 Smith, T. K., Jr., manager, Gimbel Brothers, bankers, New York City.
 Stephenson, J. E., Atlantic National Bank of Jacksonville, Jacksonville, Fla.
 Stewart, F. E., Chesborough Dwellings, Jefferson Avenue, Toledo, O.
 Stoner, T. H., cashier, The Peoples National Bank, Waynesboro, Pa.
 Stover, J. C., secretary-treasurer, Indiana Savings and Loan Association, South Bend, Ind.

T

Taylor, C. E., Jr., president, Wilmington Savings and Trust Co., Wilmington, N. C.

U

Union Trust Co. of D. C., Washington, D. C.

V

Van Blarcom, Wessels, assistant cashier, Second National Bank, Paterson, N. J.
 Van Name, Miss M. I., 515 Stephen Girard Building, Philadelphia, Pa.

W

Wadden, John W., Lake County Bank, Madison, S. D.
 Williams, F. H., assistant treasurer, Albany City Savings Institution, Albany, N. Y.
 Williams, J. E., assistant cashier, Third National Bank, Scranton, Pa.
 Wilson, C. C., c/o Continental and Commercial Trust and Savings Bank, Chicago, Ill.
 Withers, K. K., publicity manager, County Savings Bank, Scranton, Pa.

Z

Zimmerman, Frank A., Chambersburg Trust Co., Chambersburg, Pa.
 Zimmerman, Paul E., cashier, Oak Park Trust and Savings Bank, Oak Park, Ill.



France and America

THIS is the title of an interesting booklet published by the Guaranty Trust Company of New York. It recounts the many services rendered this country by France, the help extended in our Revolutionary struggle and the cession of the Louisiana Territory being the most notable, and shows the basis upon which has been built the great prosperity of the French people. The

eagerness with which public loans are absorbed, the remarkable skill in certain highly specialized forms of industry, the strong financial system, the foreign trade, and many other of the distinguishing features of French economic life are briefly yet clearly shown.

Through its Paris office the Guaranty Trust Company is in close touch with business and financial affairs in France.

American Bankers Association Programme

PROGRAMME for the Forty-third Annual Convention — American Bankers Association, September 24-29, 1917 (inclusive) at Atlantic City, N. J.

Note—All meetings at headquarters, the Marlborough-Blenheim Hotel unless otherwise noted.

Monday, September 24:

Morning—Meetings of various American Bankers Association committees and commissions; executive committees of various sections, etc.

Afternoon—Executive Council meeting at 2 o'clock in West Solarium, Blenheim side.

Tuesday, September 25:

Morning—Savings Bank Section, George E. Edwards, president (General Session) 9:30 o'clock in West Solarium, Blenheim side.

Clearing House Section, W. D. Vincent, president (Business Session) 9:30 o'clock in Banquet Room, Blenheim side.

Executive Committee, Clearing House Section, same place on adjournment of section meeting.

State Bank Section, J. H. Puelicher, president (Business Session) 9:30 o'clock in Par Avenue Hall, Marlborough side.

Executive Committee, State Bank Section, same place on adjournment of Section Meeting.

Afternoon—Trust Company Section, Uzal H. McCarter, president (General Session) 2 o'clock in West Solarium, Blenheim side.

Savings Bank Section, George E. Edwards, president (Business Session) 2 o'clock in Park Avenue Hall, Marlborough side.

Executive Committee, Savings Bank Section, same place on adjournment of Section meeting.

Clearing House Section, W. D. Vin-

cent, president (General Session) 2 o'clock in Banquet Room, Blenheim side.

Wednesday, September 26:

Morning—Trust Company Section, Uzal H. McCarter, president (Business Session) 10 o'clock in Park Avenue Hall, Marlborough side.

Executive Committee, Trust Company Section, same place on adjournment of Section meeting.

National Bank Section, Joseph S. Calfee, president (General Session) 10 o'clock in West Solarium, Blenheim side.

Afternoon—National Bank Section, Joseph S. Calfee, president (Business Session) 2 o'clock Banquet Hall, Blenheim side.

Executive Committee, National Bank Section, same place on adjournment of Section Meeting.

State Bank Section, J. H. Puelicher, president (General Session) 2 o'clock in West Solarium of Blenheim side.

State Secretaries Section, S. B. Rankin, president, 12 o'clock noon in Ocean Hall, Marlborough side.

Thursday, September 27:

General Convention—The New Nixon Theatre.

Convention called to order at 9:30 o'clock sharp, by the president, P. W. Goebel.

Invocation.

Addresses of Welcome—Hon. Walter E. Edge, Governor State of New Jersey; Hon. Harry Bacharach, Mayor Atlantic City.

Response to Addresses of Welcome and Annual Address—P. W. Goebel, Kansas City, Kan., president of the Association.

Annual Report of the General Secretary—Fred E. Farnsworth, New York.

Annual Report of the Treasurer—E. M. Wing, La Crosse, Wis.

Annual Report of the General Counsel—Thomas B. Paton, New York.

Annual Report of the Protective Department—L. W. Gammon, manager, New York.

Annual Report of the Department of Public Relations—A. D. Welton, manager, New York.

Annual Report of the Department of Contracts and Purchasing—George Lewis, manager, New York.

Annual Report of the Library—Gen. W. F. Thayer, chairman, Concord, N. H.

Amendments to the Constitution.

Eleven o'clock:

Address—Hon. William G. McAdoo, Secretary of Treasury, Washington, D. C.

Address—George M. Reynolds, president Continental and Commercial National Bank, Chicago, Ill.

Report of Insurance Committee—N. G. Parker, chairman.

Annual Report of the Executive Council—P. W. Goebel, chairman, Kansas City, Kan.

Communications.

Announcements.

Recess for luncheon.

Thursday, September 27:

General Convention—Afternoon session.

Two o'clock:

Report of Trust Company Section—Uzal H. McCarter, president.

Report of Savings Bank Section—George E. Edwards, president.

Report of Clearing House Section—W. D. Vincent, president.

Report of American Institute of Banking Section—E. G. McWilliam, president.

Report of State Secretaries Section—Major S. B. Rankin, president.

Report of National Bank Section—Joseph S. Calfee, president.

Report of State Bank Section—J. H. Puelicher, president.

Two-Thirty o'clock:

Addresses—Hon. Lord Northcliffe, head of British War Mission to the United States, London, England.

Dr. Nicholas Murray Butler, presi-

dent Columbia University, New York.

Report of Currency Commission—Hon. A. Barton Hepburn, chairman.

Report of Committee on State Legislation—G. G. Clarabut, chairman.

Report of Committee on Federal Legislation—H. H. McKee, chairman.

Communications.

Announcements.

Adjournment.

Friday, September 28:

General Convention.

Convention called to order at 9:30 o'clock sharp by President P. W. Goebel.

Invocation.

Address—Hon. Carl Vrooman, Assistant Secretary of Agriculture, Washington, D. C.

Report of Agricultural Commission—Joseph Hirsch, chairman.

Action on Report.

Eleven-Thirty o'clock:

Address—Hon. Benjamin Strong, Jr., Governor Federal Reserve Bank of New York, New York.

Report of Committee of Twenty-Five (representing country bankers)—Nathan Adams, chairman.

Communications.

Announcements.

Recess for Luncheon.

Friday, September 28:

Afternoon Session—Two o'clock.

Report of Committee on Credit Forms—W. P. Sharar, chairman.

Committees and Committee Membership.

Invitations for next Convention.

Unfinished Business.

Communications from Executive Council.

Resolutions.

Three o'clock:

Address—Rev. Newell Dwight Hillis, pastor Plymouth Church, Brooklyn, N. Y.

Report of Committee on Nominations.

Action on Report.

Installation of Officers.

Communications.

Announcements.

Adjournment, sine die.

Saturday, September 29:

In Marlborough-Blenheim Hotel.

Executive Council for organization and transaction of business, at 10 o'clock in East Solarium, Blenheim side.

The programme embodies fifty meetings during the week.

Proposed entertainment during Forty-third Annual Convention of the American Bankers Association at Atlantic City, September 24-29, 1917:

Monday Afternoon:

Yachting party at Inlet.

Monday Evening:

Reception by N. J. State Bankers Association.

Dancing and light refreshments.
All on the Steel Pier.

Tuesday Afternoon:

Four-thirty o'clock—Rolling chair parade.

Boardwalk and out on the Steel Pier.

Tuesday Evening:

Surf bathing by flood light.
Virginia Avenue baths.

Wednesday Afternoon:

Five o'clock—Drill by Life Guards.

Wednesday Evening:

Special cake walk.
Dancing.
Steel Pier.

Thursday Evening:

Fun factory.
Dancing.
Steeplechase Pier.

Friday Evening:

"Go as you please."



Canada's Jubilee

From "The Economist"

IN her 50th year Canada has cause to be both proud and thankful for many things. She is proud that she has raised an army of over 400,000 men and has sent 300,000 overseas. She is proud of her ability to contribute towards the expenses of the war, which she is doing at the rate of \$1,000,000 a day. Besides this she has contributed in a private way \$60,000,000 to the benefactions to war causes. Canada has manufactured and sent forward munitions to the value of \$510,000,000, but the prospect is even more important than the retrospect, for Canada as a nation has really only begun. Of her valuable acres numbering 440,000,000, only 110,000,000 have been occupied so far for agricultural or other purposes. We also have under forest from 500,000,000 to 600,000,000 acres.

A brief statement of the progress of our country from 1867 to 1917 is given hereunder in condensed form:

	%
She has increased her	
Area from 540,000 square miles to 3,729,665	590
Population from 3,600,000 to 7,600,000	111
Wheat crop from 17,000,000 bus. to 220,000,000 bus.	1,194
Oats and Barley crop from 54,000,000 bus. to 584,000,000 bus.	981
Dairy Production from 74,000,000 lbs. to 416,000,000 lbs.	462
Exportable Surplus of Agricultural Products from \$13,000,000 to \$480,000,000	3,592
Fisheries from \$6,500,000 to \$31,200,000	375
Minerals from \$10,000,000 to \$137,000,000	1,270
Forestry from \$34,100,000 to \$175,000,000	383
Manufactures from scarcely any to \$1,300,000,000	—

Iron and Steel from \$2,800,000 to \$49,800,000	1,648
Foundry Products from \$7,300,000 to \$36,700,000	403
Meat Products from \$3,890,000 to \$78,400,000	1,963
Smelting from \$289,000 to \$52,700,000.	17,584
Cottons from \$781,000 to \$20,500,000.	2,524
Flour Mill Products from \$39,100,000 to \$112,525,000	187
Paper from \$1,000,000 to \$29,300,000.	2,830
Steam Railway Mileage from 2,278 to 35,582	1,462
Freight handled from 5,600,000 tons to 101,390,000 tons	1,711
Passengers carried from 5,200,000 to 46,300,000	790
Electric Railways from none to 1,590 miles	—
Passengers carried none to 614,707,000	—
Postal Revenue from \$808,000 to \$13,000,000	1,509
Foreign Trade from \$114,100,000 to \$2,000,000,000	1,653
Exports from \$45,500,000 to \$1,151,300,000	2,430
Bank Assets from \$79,800,000 to \$1,839,000,000	2,192
Total Deposits from \$33,600,000 to \$1,418,000,000	4,120
School Expenditure from \$2,500,000 to \$56,000,000	2,140



To Issue Advertising Guide

THE investment Bankers Association is about to prepare, publish and distribute a working guide as to what may be considered fraudulent advertising for the use of publications in accepting such matter and for the use of brokers, dealers, and bankers, in handling it, according to the terms of a resolution passed at a meeting of the board of governors of the association.

The nominating committee of the board has recommended the following ticket of officers and governors to be voted on at the coming convention at Baltimore: President, Warren S. Hayden, Cleveland; vice-presidents, William G. Baker, Jr., Baltimore; John E. Oldham, Boston; Lawrence Chamberlain, New York; F. A. Yard, Chicago; D. K. Drake, Los Angeles; secretary, F. R. Fenton, Chicago; treasurer, George Kendrick, 3d, Philadelphia; governors, J. Sheppard Smith, St. Louis; Roy C. Osgood, Chicago; Her-

bert Witherspoon, Spokane; John A. Prescott, Kansas City; T. Johnson Ward, Philadelphia; H. C. McEldowney, Pittsburgh; Will H. Wade, Minneapolis; Robey Robinson, Atlanta, and J. S. Wilson, Jr., Baltimore.



Federal Land Bank Methods Declared Sound

THE Federal Land Bank of Columbia recently requested the president of the bankers association of each of the four states in its district to appoint a committee of three bankers and one attorney to examine the methods used by the bank in arriving at values and ascertaining the validity of titles to the lands mortgaged to the bank as security for loans. This request was complied with, and as a result seventeen representative bankers and lawyers of the district have joined in a statement to the effect that the greatest care and conservatism have been exercised by the bank, both as to titles and values, and that they heartily commend the management of the bank, and express their confidence in the security behind the farm loan bond, which the bank issues. Among the signers are the president and attorney of the South Carolina Bankers Association, the general counsel of the Georgia Bankers Association, and representative bank officers of each of the four states.



Must Win the War

JOHN J. MITCHELL,

President Illinois Trust and Savings Bank, Chicago

AS a people we must have no interest or purpose in life that stands before the winning of this war and doing it as decisively and as quickly as is possible. We must not stop to count the cost in men or money, nor in sacrifice or service.

Banking and Financial Industry

SPECIAL

**THE BANKERS
MAGAZINE**

SECTION

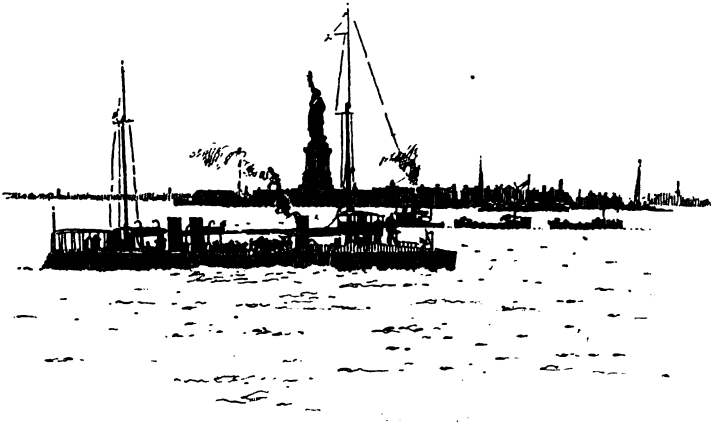

A PORT OF CALL

We want our out-of-town clients to look for more than prompt and reliable banking service from the Liberty.

We expect them to regard our bank as a port of call whenever they come to New York, so that we may profit mutually by exchanging views on banking conditions.

The Liberty National Bank

in the Equitable Building, 120 Broadway, New York

Escanaba National Bank

IT was at the end of June and on the occasion of its twenty-fifth anniversary that the Escanaba (Mich.) National Bank took possession of its new building, shown in an accompanying illustration. Before giving a brief history of the bank, it will be appropriate to tell something about the new building, which itself constitutes one of the most notable milestones in that history.

THE NEW BUILDING

An idea of the tasteful as well as solid character of the new structure may be had from the view herewith presented, but an actual inspection of it shows the appropriateness of its arrangements and the thorough adaptation of every detail to the business of a modern bank, combining elegance of appearance with comfort, convenience and safety. The building presents a realization of the high ideals which have been kept constantly in view by the management of the institution during the twenty-five years of its successful history.

In detail, the building may be thus briefly described: Upon entering the main vestibule a staircase at the left leads to the handsome offices above. Directly in front is the entrance to the bank's public lobby. The banking room is furnished in Bottocini marble, bronze and mahogany. There is a conservative tone in the decorations which makes the place almost homelike in its inviting massive simplicity.

The private office of the president occupies the main corner of the first floor to the right of the entrance. Next to this on the right are the officers' quarters, where the desks of the cashier and assistant cashier are located. Immediately following the officers' quarters are the loan and discount, receiving and paying teller cages.

The equipment of the cages is of

the most modern type, comprising numerous appliances which are essential in expediting the work. Among these appliances may be mentioned an intercommunicating telephone system for the employees, and a pneumatic tube operated by compressed air to facilitate exchange between tellers and bookkeepers, in fact, the arrangement of the cage is such that a teller can transact every branch of the business pertaining to his work without leaving it.

At the left entrance is a commodious ladies' room, handsomely furnished. All conveniences possible are installed in this room, and a toilet and lavatory adjoins it. Immediately following is a customers' room for the accommodation of the public, then in order follow the bookkeeping department and savings teller cage.

Through the heavy bronze grill which separates the lobby from the working space can be seen a cash and safe deposit vault equipped with the latest improvements. The door of this vault is of a circular screw design with an eight foot opening. The door alone weighs seventeen tons and is capable of standing a tension strain of 60,000 pounds to the square inch.

There are three separate and distinct vaults. The cash and safety deposit vault in the center, the book vault to the left, and the storage vault in the basement. The walls of the vault are of an unusually thick construction, reinforced with steel rods and lined with hardened chrome steel, and afford adequate protection against fire and every known method practiced by burglars.

In pursuance of its policy of favoring home industry, the bank had a great deal of the work on the new building done by local firms.

HISTORICAL SKETCH OF THE BANK

Twenty-five years ago, when Escanaba had but about 8,000 population and

only one bank, Messrs. John K. Stack and John Corcoran organized the Bank of Escanaba. As the foundation stones of the bank's policy, they devoted themselves to upbuilding the interests of the community and gave courteous personal

Wishing to be better able to serve the banking needs of the community, the Bank of Escanaba was converted into the Escanaba National Bank in 1907. As it had always been the policy of the bank to give first consideration to home



Escanaba National Bank

attention to all the details of the bank's business.

Their policy succeeded, and the bank continued to grow under their direction. For the first twelve years there was no change in the management, and then Mr. Corcoran died and the interest of his estate in the bank was bought by Mr. Stack, M. N. Smith becoming cashier.

interests, the stock of the institution was not offered to outside investors, but was placed with those in the vicinity who feel a personal interest in the institution's prosperity.

The growth of the bank and its efficiency as a servant of its business neighborhood are illustrated by the fact that the deposits, which were \$405,861.08 in 1907, rose to \$1,009,773.07 at

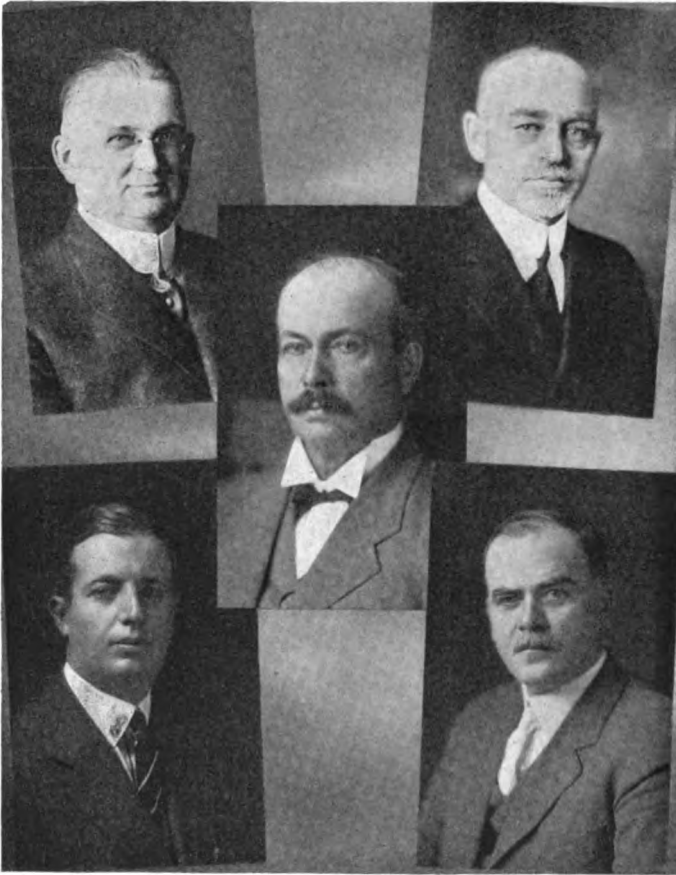

H. W. READE J. K. STACK, President G. M. MASHEK
 G. T. STEPHENSON M. N. SMITH, Cashier
 Officers and Directors of The Escanaba National Bank

the end of 1916—a gain of 250 per cent. At the end of last year the capital was \$100,000; surplus and profits, \$91,767.03, and total resources \$1,301,540.10.

THOSE WHO MANAGE THE BANK

Results, in banking or any kind of business, are the witnesses of the worth of those who exercise control. The new building of the Escanaba National Bank and the growth of business are unassailable proofs of the financial skill and judgment and of the integrity of its management. The officers responsible for the bank's fine record are: J. K. Stack, president; J. C. Kirkpatrick, vice-president; M. N. Smith, cashier,

and J. E. Mogan, assistant cashier. The directors are J. K. Stack, J. C. Kirkpatrick, M. N. Smith, C. W. Kates, J. J. Cleary, H. W. Reade, Dr. J. O. Groos, G. M. Mashek and G. T. Stephenson. M. N. Smith, cashier and active in the management of the bank, is supported by an efficient staff of employees. The loan and discount department is in charge of James E. Mogan, assistant cashier. Wm. J. Schmit is receiving and paying teller. Walter Nelson is savings teller and in charge of safety deposit department. William Leiper is bookkeeper, Miss Josephine Loeffler, stenographer, and Earl Essington, messenger. Directors of the bank

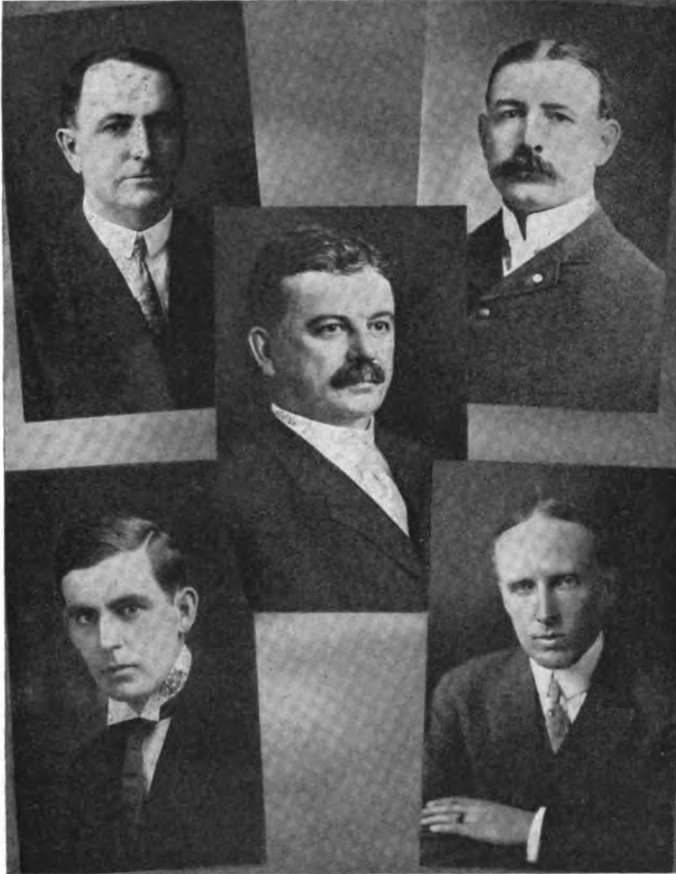

J. J. CLEARY
 J. C. KIRKPATRICK, Vice-President
 DR. J. O. GROOS
 J. E. MOGAN, Assistant Cashier
 C. W. KATES
 Officers and Directors of The Escanaba National Bank

are: J. K. Stack, J. C. Kirkpatrick, C. W. Kates, G. M. Mashek, J. O. Groos, H. W. Reade, J. J. Cleary, G. T. Stephenson and M. N. Smith. Collectively these men represent Escanaba enterprises with an investment of capital amounting to about \$9,500,000, employing some 1,700 men, and paying out annually in the community as wages \$1,400,000.

Carefully weighing all the factors which enter into the composition of a strong and healthy bank, it will be seen that the Escanaba National Bank possesses to a very large degree the essentials of a safe and successful bank.

Economical Device for Handling Outgoing Mail

WITH the multiplication of correspondence in the larger banking institutions there has arisen a necessity for economizing time and labor in handling the large amount of daily outgoing mail.

The device illustrated herewith, which is called the Mailometer, would seem to go far towards the solution of this difficulty. It is a combined sealing and stamping machine, which seals, stamps and counts envelopes at the rate of 250 per minute.

Not only does it handle the mail with

this astonishing speed, but it maintains a check upon the postage in this way: 1,000 stamps in a coil are securely locked in the Mailometer, and each stamp is automatically registered under lock, as it is affixed to the envelope. This avoids the promiscuous handling of stamps, with the possibility of loss, confining responsibility to a single em-

Detroit and marketed by the Mailometer Sales Co., Chicago and New York.



Successful School Savings Bank

New York, August 2, 1917.

Editor BANKERS MAGAZINE.

Sir: About six years ago my principal suggested the idea of a School Bank and remarked that if I thought well of it, I might proceed and organize one for our school, and he would encourage it. After making a thorough study of the subject, I organized the Savings Bank of Public School No. 14 on February 20, 1911. Since then, in the six years of its existence, we have saved for our pupils, over and above all withdrawals, more than forty-five thousand dollars! This is all the more remarkable when you consider that our school is located in one of the poorest neighborhoods in New York.

I thought this report would interest your readers and took the liberty of sending it to you.

Very sincerely yours,

HERMAN J. SENENBERG,

Bank Manager Savings Bank
of Public School No. 14.



14,000 Teuton Bank Clerks Are at Front

AT the annual convention of the German bank clerks at Magdeburg, Prussia, it was announced that 14,000 of its members were in service at the front.

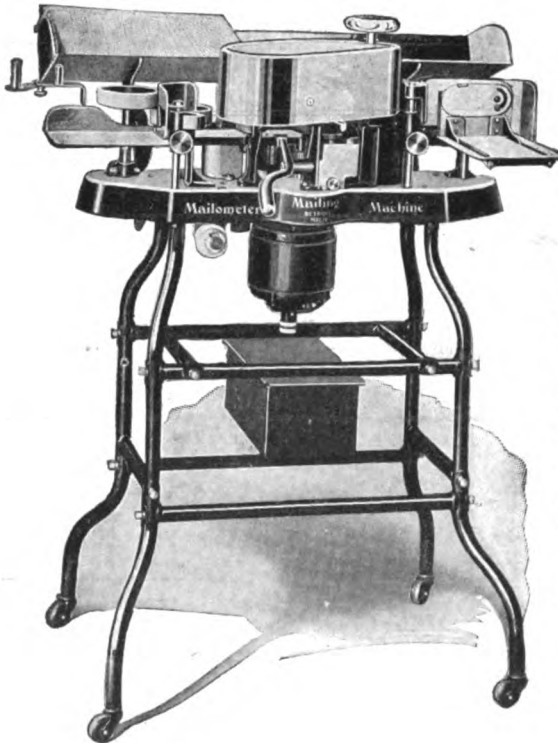

ployee, upon whom the machine "keeps tab."

On the score of economy it is said that the Mailometer seals, stamps and counts the envelopes for less than the cost of sealing alone under the old way.

Its advantage to banks does not consist alone in the speed with which ordinary mail may be handled, but it enables the transit department to save loss of interest and to convert checks into cash much more rapidly than has been possible heretofore.

The new device is manufactured in

Banking and Financial Notes

GUARANTY TRUST COMPANY APPOINTS MANAGING COMMITTEE

The Guaranty Trust Company of New York announces the appointment of a managing committee in order to facilitate the handling of its rapidly growing business in the various fields of banking in which it is engaged. Executive authority in the direction of the affairs of the company is vested in this committee, under the general supervision of the president, Charles H. Sabin. The committee is composed of six vice-presidents, viz.: Grayson M. P. Murphy, William P. Conway, Albert Breton, N. D. Jay, Eugene W. Stetson and John J. Lewis.

Decisions on all matters of current business, questions of office policy, the extension of the business of the institution, negotiations regarding loans and financing, reorganizations, and the general control of the offices and representatives in other cities of the United States and abroad, are in charge of this committee.

A statement of the Guaranty Trust Company, dated July 31, 1917, shows a capital of \$25,000,000; surplus and undivided profits, \$28,291,164.50; deposits, \$500,104,475.47; and total resources, \$603,212,379.84.

The company now has an organization of more than 1,500 employees.

ISSUES BOOKLET ON FRANCE AND AMERICA

Realizing that the arrival of the United States Army in France marked an epoch in the histories of the great sister republics, the Guaranty Trust Company has issued a booklet entitled "France and America." It briefly outlines some of the services which the trust company's recently opened Paris office offers not only to American business concerns and individuals, but also to those who are with the armies in

France; deals with the mutual interests and obligations of the two countries, and presents a readable sketch of the common love of liberty, justice and humanity that have united their peoples for nearly a hundred and fifty years.

The booklet will have a timely appeal because, through her heroic struggle, France has kindled a deeper sentiment in the United States than has ever before existed, although the land of Lafayette, Rochambeau and De Grasse has always held our regard. It makes clear the reasons why France is to-day "a country which maintains to the maximum of her power, without hesitation



The Branch
Our first President

Merchants National Bank

RICHMOND, VA.

Capital \$400,000
Surplus and Profits over 1,000,000

The Gateway to and Collection
Center for Southeastern States

Send Us Your Items

"ON TO RICHMOND"

Kings County Trust Company

City of New York, Borough of Brooklyn

Capital \$500,000 Surplus \$2,000,000 Undivided Profits \$800,000

OFFICERS

JULIAN P. FAIRCHILD, WILLIAM HARKNESS, D. W. McWILLIAMS, WILLIAM J. WASON, JR.,	JULIAN D. FAIRCHILD, <i>President</i> THOMAS BLAKE, <i>Secretary</i> HOWARD D. JOOST, <i>Assistant Secretary</i> J. NORMAN CARPENTER, <i>Trust Officer</i> GEORGE V. BROWER, <i>Counsel</i>
} <i>Vice-Presidents</i>	

ACCOUNTS INVITED.

INTEREST ALLOWED ON DEPOSITS.

and without weakness, her strength, her means, and her will."

APPOINTED ASSISTANT TRAFFIC MANAGER

The American Steel Export Company announces the appointment of Walter R. Morris as assistant traffic manager with headquarters in the Woolworth building, New York city. Because of suspended service for an indefinite period of American-Hawaiian steamers via Panama Canal, Mr. Morris resigned his position as assistant traffic manager of the American-Hawaiian Steamship Company, New York, to accept employment with the American Steel Export Company. Prior to his connection with the Panama Canal Line in 1910, then known as the Tehautepec Route, Mr. Morris was for a great many years associated with the Southern Pacific and Pacific Mail companies in their traffic departments at both San Francisco and New York.

PUBLISHES NEW A. B. A. CHECKS CATALOGUE

A new and unusually attractive catalogue of materials to aid bankers in their sales of American Bankers Association checks has just been issued by the Bankers Trust Company of New York.

The catalogue contains carefully prepared newspaper cuts, a postcard done in striking colors; and two street car cards in colors; and two attractive new booklets. "All over the Americas" describes the uses of "A. B. A." checks

in the Western hemisphere; "Oriental Travel Money—Ancient and Modern" gives helpful information to persons traveling to Hawaii, the Philippines, and the Far East. Curious forms of money used in ancient Japan are reproduced on the cover of this booklet.

So strong has been the demand from all over the country for lantern slides bearing the imprint of the local bank that new ones have been prepared with especial care and this year's slides are unusually beautiful. Of particular interest just now is the historical series, showing Bunker Hill and Washington Monuments, the Alamo, Independence Hall, and the Capitol.

A novel feature is the window display, consisting of the floating check so familiar to magazine readers. It is about 30 by 15 inches in size, and on it are seated two figures, cut from the cardboard, with their baggage. The check is suspended from the centre by a fine elastic cord, and the edges are held loosely in a horizontal position by invisible threads. When a small electric fan is concealed underneath, the check seems to be actually floating along.

Most interesting of all, perhaps, is the new motion picture, now being made, which will be ready for distribution September 15. This picture is being prepared with great care. A large demand for it is anticipated, judging from the success of the picture sent out last year, which has been seen by millions of persons all over the United States.



The Chemical National Bank of New York

(Established 1824)

A Bank for Bankers

THE unshaken solidity of this institution through every financial crisis since its founding in 1824 constitutes one of several reasons why it is the logical depository for the funds of Banks, Bankers, Corporations, Institutions, and Estates as well as Individuals!

Interest paid on Balances of Banks, Time Deposits and Special and Reserve Accounts.

Correspondence solicited

H. K. Twitchell, President
Percy H. Johnston, Vice-President
Francis Halpin, Vice-President
I. B. Hopper, Vice-President
E. H. Smith, Cashier

James L. Parson, Assistant Cashier
J. G. Schmelzel, Assistant Cashier
John B. Dodd, Assistant Cashier
Samuel T. Jones, Assistant Cashier
H. M. Rogers, Mgr. Foreign Dept.

DIRECTORS

Frederic W. Stevens
W. Emlen Roosevelt

Robert Walton Goelet
Charles Cheney
Percy H. Johnston

Arthur Iselin
Frederic A. Juilliard

Ridley Watts
H. K. Twitchell

REPORT OF NEW YORK STATE BANKING DEPARTMENT

The fact that 210 banks under the supervision of the New York State Banking Department increased their resources \$35,962,415 from February 28, 1917, to June 20, 1917, is brought out in the last report of the department. Deposits in these same institutions increased \$31,353,362, making a total of \$786,977,415. Surplus including all undivided profits on market value decreased from \$57,538,229 to \$36,897,246.

FEDERAL RESERVE ACT AMENDMENT

Under date of August 8, 1917, the Federal Reserve Bank of New York sent out a letter briefly summarizing the amendments to the Federal Reserve Act approved June 21, 1917:

Any bank or trust company becoming a member of the Federal Reserve System thereby is entitled to all the rights of a member bank, which include the following:

- (a) To rediscount eligible commercial paper with Federal Reserve Bank;
- (b) To receive advances from the Federal Reserve bank, for periods not exceeding fifteen days, on the member bank's own promissory note, secured by commercial paper or Government bonds or notes;
- (c) To obtain Federal Reserve notes and other currency as needed, from the Federal Reserve Bank;
- (d) To receive deposits of postal savings and other Government funds;
- (e) To "accept" draft and bills of exchange based on foreign or domestic commerce, subject to certain conditions, if state charter permits;
- (f) To have checks and drafts drawn upon it received at par by all Federal Reserve Banks;
- (g) To make its drafts on the Federal Reserve Bank available for immediate credit at any Federal Reserve Bank;
- (h) To participate in the check clearing and collection facilities of the Federal Reserve System.

The amended provisions of the Federal Reserve Act now in effect governing the reserve to be maintained by banks which are members of the Federal Reserve System, are as follows:

Country Banks:

Seven per cent of demand deposits,
Three per cent. of time deposits.

Reserve City Banks:

Ten per cent. of demand deposits,
Three per cent. of time deposits.



100 YEARS OF COMMERCIAL BANKING

LOUIS G. KAUFMAN
President

FRANK J. HEANEY

Vice President

WILLIAM H. STRAWN

Vice-President

NORBORNE P. GATLING

Vice-President

H. A. CLINKUNBROOMER

Vice-President

ROLFE E. BOLLING

Vice-President

WALLACE T. PERKINS

Vice-President

WALTER B. BOICE

Asst. Cashier

VINTON M. NORRIS

Asst. Cashier

RICHARD H. HIGGINS

Vice-President

BERT L. HASKINS

Vice-Pres. and Cashier

C. STANLEY MITCHELL

Vice-President

MAX MARKELL

Vice-President

GEORGE R. BAKER

Vice-President

HENRY L. CADMUS

Asst. Cashier

HENRY C. HOOLEY

Asst. Cashier

JOSEPH BROWN

Asst. Cashier

GEORGE M. HARD
Chairman

ACCOUNTS INVITED

Resources Ninety-six Million Dollars

Central Reserve City Banks:

Thirteen per cent. of demand deposits,
Three per cent. of time deposits.

The entire legal reserve of a member bank is now to be maintained on deposit with the Federal Reserve Bank, and there is no requirement of law as to the amount or kind of currency to be held by a member bank in its own vault.

BASEBALL TITLE TO BANKERS TRUST

By defeating the team from the Guaranty Trust Company on July 28, 1917, the score being 9 to 3, the Bankers Trust Company won the championship in the Bank Clerks League.

ENTERTAINMENT FOR A. B. A. AT ATLANTIC CITY

Elaborate plans of entertainment have been worked out for the A. B. A. convention which is to be held at Atlantic City the week of September 24, 1917. As the plans now stand, on Monday afternoon, September 24, there will be a yachting party at the Inlet, and in the evening a reception by the New Jersey Bankers Association on the Steel Pier, with dancing; Tuesday, at 4:30 p. m., there will be a rolling chair parade on the Boardwalk and out on the Steel Pier; and in the evening surf bathing by flood light at the Virginia Avenue Baths. An exhibition drill by life guards will be witnessed at 5 p. m.,

Wednesday, with a cake walk and dancing in the evening on the Steel Pier. Nothing formal was planned for either Thursday or Friday evening, the idea being to have a "go as you please" of the Boardwalk and the various piers.

NEW VICE-PRESIDENT CHATHAM AND PHOENIX

W. T. Perkins, formerly vice-president of the National City Bank of Chicago, became on August 15, 1917, a vice-president of the Chatham and Phoenix National Bank of New York. He will have charge of the Western business for the bank. Mr. Perkins was one of the assistant cashiers of the Hamilton National Bank at the time that bank was taken over by the National City Bank of Chicago and subsequently became an assistant cashier of this institution. From this position he worked his way to vice-presidency.

REPORTS INVESTMENT SITUATION

The August 15, 1917, monthly investment letter issued by Knauth, Nachod and Kuhne reports the present investment situation as follows:

Activity continues in most branches of business and the country handled last month sufficient transactions to swell the volume of bank clearings to the highest level ever touched in July. The large industries have an immense amount of orders on their books and were it not for the uncertainty caused by the devel-

"The Bank That Service Built"

**THE
SEABOARD NATIONAL BANK
OF THE CITY OF NEW YORK**

Capital \$1,000,000
Surplus and Profits (Earned) 3,168,263
Deposits 57,000,000

S. G. BAYNE, President

C. C. THOMPSON, Vice-President

O. M. JEFFERDS, Asst. Cashier

B. L. GILL, Vice-President

C. C. FISHER, Asst. Cashier

W. K. CLEVERLEY, Vice-President

J. D. SMITH, Asst. Cashier

L. N. DeVAUSNEY, Vice-President

B. I. DADSON, Asst. Cashier

IL. W. DONOVAN, Cashier

J. E. ORR, Asst. Cashier

DIRECTORS

SAMUEL G. BAYNE

HENRY C. FOLGER

STUART G. NELSON

WILLIAM K. CLEVERLEY

BENNETT L. GILL

JOSEPH SEEP

EDWARD J. CORNISH

EDW. H. R. GREEN

CHARLES C. THOMPSON

MICHAEL J. DEGNON

PETER McDONNELL

WILLIAM H. WOODIN

The success of this bank is founded upon a policy of painstaking, efficient and courteous service to all

ACCOUNTS INVITED

opments of the Government's price-fixing campaign and prevailing doubt as to the burdens of war taxation, the expansion in mercantile lines would be more pronounced. But the showing is quite remarkable for a country that is at war. This explains in a measure the resistance of the stock market to all efforts to depress prices. The seasoned dividend paying issues have held up well and although there have been periods of heavy selling, these, for the most part, have been followed by quick upward reactions. The relative firmness of both railroad and industrial shares may be accounted for largely by the unusual earnings that are being reported by many of the largest corporations in the United States.

COMMENTS ON OUR ECONOMIC POSITION

The July 25, 1917, issue of the monthly letter of the Mechanics and Metals National Bank of New York summarizes the economic position of the United States as follows:

The economic fruit of America's part in world affairs since the beginning of the war is token of what may still be ahead. We continue, by reason of our agricultural and mineral resources, our industrial capacity and our trade facilities, to be the centre of concentrated buying from abroad. Since the beginning of the war, the United States has gained tremendously in world position. This is measured in our trade figures. From August 1, 1914, up to the present time, we have sold our products to foreign countries at liberal profits to the amount of \$14,000,000,000.

Our favorable trade balance—surplus of exports over imports—has been \$7,500,000,000.

With this balance we have strengthened our international position in a manner that suggests what the future may be, if we go the way we have been going. In less than three years we have repurchased and brought back from abroad our own securities to an amount of \$3,000,000,000. We have loaned to other countries a still greater amount at full interest. We have imported more than \$1,000,000,000 in gold.

NEW YORK BANK AIDS INDUSTRY

The National City Bank has established an industrial service department, the purpose of which will be to help its patrons to solve their industrial problems. The department has been placed in charge of Vice-President F. C. Schwedtman, who has had much experience in industrial management.

"There are many signs," says the bank's announcement, "which indicate that production in all the industries is going to be more scientifically conducted in the future than it has been in the past. Industries are not going to grow up quite so much at random or be managed quite so much by rule-of-thumb as heretofore. They will be

National Bank of Commerce in New York

PRESIDENT

JAMES S. ALEXANDER

VICE-PRESIDENTS

R. G. HUTCHINS, JR.
HERBERT P. HOWELL
J. HOWARD ARDREY
STEVENSON E. WARD
JOHN E. ROVENSKY
GUY EMERSON

CASHIER

PARIS R. RUSSELL



AUDITOR

A. F. JOHNSON

ASSISTANT CASHIERS

A. J. OXENHAM
WILLIAM M. ST. JOHN
LOUIS A. KEIDEL
A. F. MAXWELL
JOHN J. KEENAN
GASTON L. GHEGAN
A. F. BRODERICK
EVERETT E. RISLEY
H. P. BARRAND
R. W. SAUNDERS
H. W. SCHRADER
R. E. STACK

MANAGER FOREIGN DEPARTMENT

FRANZ MEYER

CAPITAL, SURPLUS AND UNDIVIDED PROFITS OVER \$45,000,000

more carefully located, methods will be more generally standardized, relations with employees will receive greater consideration, and from the beginning of the process to the end every detail will be studied to obtain greater efficiency. Many of our manufacturers have been making good progress along these lines, but the investigations of the Federal Trade Commission show that, taking the whole body, there is vast room for improvement, even in the matter of calculating costs. A majority of them, according to the commission, lack an adequate system of cost keeping."

According to the bank's announcement, the war is causing an increase in our industrial capacity, and it will be a problem to keep this capacity employed when the war's demands fall off and the first urgent peace demands are satisfied.

"We must be able to hold our own in competition with other countries," the announcement says, "and, furthermore, we must understand that the home demand for everything can be increased by reducing the cost. If everything we consume were halved in price we could buy twice as much, provided the reduction was accomplished by a corresponding reduction in production costs."

To be well informed about a manufacturing business there is much that a banker ought to know beyond the amount invested in it, or even the

"quick" assets shown by the inventory and past profits shown by earning statements, and it is for the purpose of making it possible for bank officials to be informed of the facts that the bank has determined to establish its "service department."

GOES WITH MERCANTILE TRUST AND DEPOSIT

H.D. Campbell, vice-president of the Washington Savings and Loan Association of Seattle, Wash., became on September 1 treasurer of the Mercantile Trust and Deposit Company of New York. Mr. Campbell is a graduate of the University of Minnesota and has received his law degree from the same institution. Before his connection with the Washington Savings and Loan Company he practiced law for a time in Minneapolis and later was assistant manager of the Independent Telephone Company.

CONFERS MILITARY TITLE ON BANKERS

President Wilson recently conferred the title of Major General upon H. P. Davison, a member of the firm of J. P. Morgan & Co., who has laid aside his usual duties to become chairman of the Red Cross War Council. The title of Brigadier General was conferred upon G. M. P. Murphy, a vice-president of the Guaranty Trust Company, who has become a major of the National Reserve

Service

The Citizens National Bank of New York for sixty-six years has specialized in accounts of merchants, and is located in the heart of the district where the largest part of New York's mercantile business is transacted.

We are thoroughly equipped to render the best of service to correspondent banks covering their requirements of every nature in New York.

THE CITIZENS NATIONAL BANK OF NEW YORK

Capital, Surplus and Undivided Profits \$5,000,000

EDWIN S. SCHENCK, President

FRANCIS M. BACON, JR., Vice-Pres.

ALBION K. CHAPMAN, Cashier

JESSE M. SMITH, Asst. Cashier

GARRARD COMLY, Vice-Pres.

JAMES McALLISTER, Asst. Cashier

WILLIAM M. HAINES, Asst. Cashier

Corps. To H. D. Gibson, president of the Liberty National Bank, was given the title of Colonel. Mr. Gibson is general manager and director general of the Red Cross.

ISSUES BOOKLET ON FEDERAL RESERVE BANKS

The National Bank of Commerce in New York has prepared a booklet on the law, rules, and regulations governing acceptances, rediscounts, and open market transactions of Federal Reserve Banks.

MERCANTILE BANK IN VENEZUELA

The Mercantile Bank of the Americas, Incorporated, in New York, is organizing a subsidiary bank in Caracas, Venezuela. For some time the bank has, through its agents, been doing an active business in this country, but it is now adopting a broader policy and later expects to establish branches in other cities of that country.

STATEMENT OF METROPOLITAN TRUST

The last statement of the Metropolitan Trust Company of New York as of June 20, 1917, shows total resources of \$66,747,492.73, of which \$39,414,768.78 is in loans. The bank has a capital stock of \$2,000,000, surplus and undivided profits of \$5,067.472 and deposits of \$56,128,470.

NEW DIRECTOR METROPOLITAN TRUST

C. J. McDermott has recently been elected a director of the Metropolitan Trust Company of New York. Mr. McDermott is president of the Brooklyn Bar Association and a trustee of the Hamilton Trust Company of Brooklyn.

DEATH OF HENRY J. OLDRING

Henry J. Oldring, who was president of the old Mechanics and Traders Bank of Greenpoint at the time of its merger with the Corn Exchange Bank, died in Brooklyn on August 7, 1917. Mr.



A BETTER SERVICE

In these days of highly developed banking methods, we know that we can only make headway by providing a service which is a little bit better than the other fellow's.

ATLANTIC NATIONAL BANK

257 BROADWAY, NEW YORK

CAPITAL, SURPLUS AND UNDIVIDED PROFITS \$1,800,000

RESOURCES OVER \$20,000,000

Oldring was first employed by the old Farmers and Citizens Bank of Brooklyn and later with the First National Bank of Brooklyn. From there he went to the Mechanics and Traders as cashier and later became president.

FRANKLIN NATIONAL ON GENERAL BUSINESS

The Franklin National Bank of Philadelphia in its August digest of trade conditions sums up the general business conditions in the following manner:

Practically all factors underlying general business show large volume and a high degree of activity and in several cases a noteworthy advance has been made in the past month. Less favorable conditions, wherever found, are apparently the result either of temporary shortages of labor or materials, or of readjustment to some condition created by the war.

PHILADELPHIA BUSINESS CONDITIONS

The First National Bank of Philadelphia in its August 15, 1917, monthly news and financial letter reports general business conditions as follows:

General business in this district is excellent for most lines. The large industries are still dominated by Government orders which naturally come ahead of everything else. The margin of profit is relatively large, however, notwithstanding the increased cost of labor and raw materials. It is becoming each day, however, more difficult to do business, owing to the limited supply of many raw materials used extensively by Philadelphia manufacturers. A continuous process of readjustment is taking place in the effort to meet the extraordinary situation created by the war and the complications which result from it. There will be plenty of money for crop movement purposes, but it is clear that the total amount required may reach record proportions.

LEAVES SYRACUSE TRUST COMPANY

Anthony Lamb has resigned as vice-president and director of the Syracuse Trust Company. His position will be filled by E. B. Clare-Avery. Mr. Lamb was formerly vice-president and cashier of the Commercial National Bank of Syracuse at the time of its absorption by the Syracuse Trust Company.

ILION NATIONAL BANK IN NEW HOME

A new epoch in the history of the old and substantial Iliion National Bank of Iliion, N. Y., began last month when

Hoggson Brothers, the New York builders, turned over to the bank the keys to its new banking quarters. Not only did the people of Iliion take advantage of the invitation extended by the officers to attend the opening reception and inspect the banking room, but crowds from the surrounding country were present.

The quarters are thoroughly up to the minute in appearance and equipment, and the new exterior with four stately looking fluted pilasters and cornice has an aspect of substantial architectural beauty as well as structural strength and dignity.

Charles Harter, the present president of the Iliion National Bank, has held that office since 1886, and was one of the founders of the bank when it was organized in 1867, serving as the first cashier of the institution. The other officers of the bank are Arleigh D. Richardson, vice-president, and George H. Watson, cashier.

OPENS NEW BRANCH

Recently the Citizens Commercial Trust Company of Buffalo opened a new branch at 74 Grand street. The interior of the bank is finished in red mahogany and makes an unusually fine appearance. Miles Freeman, who formerly was at the bank's William street branch, has charge of the new office.

PITTSBURGH CONDITIONS

Commenting on local conditions, the People's National Bank of Pittsburgh in its August commercial and business letter says:

During most of the month of July weather conditions were favorable to maximum industrial operations in mill and furnace, which are sometimes interfered with by excessive heat. The Pittsburgh district was also comparatively free from labor strikes, such as prevailed in the middle west, in the mining districts of Arizona and Colorado, the lumber regions of the north-west, and in various other sections of the country. Local bank exchanges in July foot up \$342,000,000, an increase of \$60,000,000 over the same month last year, and were well above the monthly average of the year to date.

While the price-fixing legislation before congress did not interfere with current operations here in mine, mill and factory, it was of paramount interest in industrial circles. President Wilson's statement to the effect that there should not be one price for government supplies and

Resources

\$15,000,000.00

If intelligent handling of items and low rates appeal to you send us your Buffalo business



Try our Service
and you will be entirely satisfied

- A. D. BISSELL, President**
C. R. HUNTLEY, Vice-Pres.
E. H. HUTCHINSON, Vice-Pres.
E. J. NEWELL, Vice-Pres.
HOWARD BISSELL, Cashier
C. G. FEIL, Asst. Cashier
A. J. ALLARD, Asst. Cashier
G. H. BANGERT, Asst. Cashier

BUFFALO NOW THE AEROPLANE CENTER OF THE COUNTRY. Our industries are well diversified, but Buffalo is particularly noted for its intensive activities in:—Grain—Steel—Automobiles—Lumber—Aeroplanes, and many others in addition to being one of the most important Ports and Railroad Centers.

For information pertaining to the City or its industries—write us

Citizens Commercial Trust Company
Buffalo
Capital and Surplus, \$2,500,000

another and much higher price for private consumers, made a decided impression on public sentiment. This was reflected in the almost continuous sagging tendency in the market value of industrial shares, and it may have been responsible for the falling off in unfilled orders booked by the steel companies.

OLD COLONY TRUST DEPARTMENT

The Old Colony News Letter which is the house organ of the Old Colony Trust Company of Boston, contains in

its August number some interesting facts about the trust department of the bank. The letter says:

On July 1, 1917, the total par value of the securities held by this company, in its trust department, under its corporate trusts, amounted to over \$325,000,000.

To show the growth of this branch of the trust department's work, during the past decade, we submit the following table:

Year	Number of issues	Total authorized amount	Total amount issued.
1907	..253	\$714,114,000	\$550,453,500
1917	..302	1,101,831,000	938,156,000

OCEANIC COMMERCE COMMISSION

The foreign trade letter of the First National Bank of Boston commenting on the international oceanic commerce commission, says:

An important step in the government's program of regulating our industrial and commercial organizations is the recent establishment of an International Oceanic Commerce Commission whose prime function will be the adjustment of ocean freight rates. Details of this task are now being worked out by the chairman of the shipping board, as the representative of the United States Government in conjunction with the representatives of the Allies. It has been stated that all parties interested are desirous to arrange a universal schedule of ocean freight rates. Ocean freight rates at present are extremely high, on account of U-boat sinkings and a general shortage of cargo space for the transportation of foodstuffs and other export articles. It is hinted that our own shipping board, in conjunction with those commissions established by the Allies for the same purposes, will probably commandeer private shipping and centralize it under an international commission composed of the representatives of the allied nations. It is hoped that through this arrangement cargo spaces will be allotted in an impartial and fair manner, both to private and government shipping interests, and that the freight rates may be cut down thereby to reasonable figures.

ESTABLISHES BUENOS AIRES BRANCH

The First National Bank of Boston has opened its new Buenos Aires

The $\frac{B}{L}$ Bank of Chicago



We make a specialty of the collection of bill of lading drafts. We guarantee prompt, accurate and intelligent handling. This is one feature of our varied service offered correspondent banks.

We solicit correspondence regarding par collection of Western items for Eastern banks, and of Eastern items for Western banks.

UNION TRUST COMPANY
Chicago

An old, conservative bank doing strictly a commercial business—Established 1869



EQUIPPED FOR SERVICE

Located in a modern building with every facility for the efficient handling of its business, this bank is in a position to offer you prompt and adequate service in your Philadelphia banking transactions.

**UNION
NATIONAL
BANK**

PHILADELPHIA

Resources over
\$13,000,000



branch, Argentina, under the management of N. F. Tribe, who has for some time resided in Argentina. The First National has a paid-in capital of \$7,500,000 and a surplus fund of \$15,000,000. Deposits amount to \$109,448,481 and total resources are \$158,917,915.

BECOMES VICE-PRESIDENT NATIONAL SHAWMUT BANK

John Bolinger, assistant manager of the foreign department of the Guaranty Trust Company of New York, was elected a vice-president of the National Shawmut Bank of Boston on July 26. He assumed his new duties on August 1, and will have charge of the foreign commercial department of that institution.

Mr. Bolinger has been connected with the Guaranty Trust Company for almost thirteen years. He was appointed assistant manager of the foreign department in September, 1913.

Mr. Bolinger was born in Kaiser-augst, Switzerland, May 19, 1879, and

is a naturalized citizen of the United States. He gained his first banking experience with the Banque Cantonale, of Neuchatel, Switzerland. Later he was with the Basler Handelsbank of Basle. Subsequently he went to England and entered the London office of the Societe Generale, where he remained about one year before coming to the United States.

NEW QUARTERS FOR NEWPORT (N. H.) BANK

The First National Bank of Newport, N. H., has moved to temporary quarters to permit of the remodelling of its banking room by Hoggson Brothers.

The new exterior will be designed in harmony with the original architecture of the Richards Block, in which the bank is located, the entrance vestibule being accentuated by granite pilasters with moulded caps supporting a cornice and pediment carried out along classic lines.

Opposite the entrance, at the front of



At the Gateway to the Great Southwest

The National Bank of Commerce

IN ST. LOUIS

offers its services for the prompt and dependable handling of your banking business in this section of the country

Capital, Surplus and Profits, over \$13,000,000.00

*“Large enough to serve any—
Strong enough to protect all”*

TOM RANDOLPH, Chairman of the Board

JOHN G. LONSDALE, President

W. L. McDONALD, Vice-President

W. B. COWEN, Vice-President

J. A. LEWIS, Vice-President and Cashier

the banking-room, will be the officers' space separated from the public by a low marble rail, and adjoining this in the rear of the counter-screen will be the working space equipped with all the appliances that go to make the modern banking institution. The directors' room, finished in mahogany, will be in the rear of the building, as well as the coupon-booths and the safe deposit vault.

The counter-screen will have a wainscot of Listavena marble. The color scheme of walls and ceiling will be carried out in harmonizing tones.

A customers' room thirteen by twenty feet, equipped with all modern conveniences, will be located in the basement.

GOES WITH RED CROSS

John M. Miller, Jr., president of the First National Bank of Richmond, Virginia, has been appointed president of the Virginia division of the American Red Cross. H. W. Anderson, who formerly was president, has been

appointed chairman of the Red Cross mission to Rumania.

BANK MERGER AT RICHMOND

The merger of the Old Dominion Trust Company and the Richmond Bank and Trust Company, establishes in Richmond one of the largest trust and banking houses in the entire South. The consolidation of the two financial institutions has just been effected, the Richmond Bank and Trust Company passing out of existence, the merged institution retaining the name of the Old Dominion Trust Company. The officers of the latter are retained in full and the officers and clerks of the Richmond Bank and Trust Company are all provided for.

For months there have been rumors of the merger of several Richmond banks, but only the two mentioned were included.

The consolidated company will use the home of the Old Dominion Trust Company, one of the handsomest and

The National Shawmut Bank of Boston

President
WILLIAM A. GASTON

Vice-Presidents
HAROLD MURDOCK
ABRAM T. COLLIER
NORMAN I. ADAMS
ROBERT S. POTTER

Cashier
WILLIAM A. BURNHAM, JR.



Assistant Cashiers
HENRY F. SMITH
FRANK HOUGHTON
FRANK A. NEWELL
GEORGE H. S. SOULE
GEORGE E. FICKETT

Auditor
CLARENCE E. DUNAVEN
Credit Manager
JAMES E. RYDER

Capital \$10,000,000

Surplus \$5,000,000

Undiv. Profits \$3,600,000

most commodious banking houses in Richmond.

According to the latest statement the capital of the Old Dominion Trust Company is \$1,000,000, total resources over \$3,800,000, deposits in excess of \$1,600,000, and surplus and undivided profits more than \$1,190,000. The capital of the Richmond Bank and Trust Company is \$477,400, total resources more than \$2,600,000, total deposits in excess of \$1,325,000, and surplus and undivided profits \$200,000.

Officers of the Old Dominion Trust Company are: W. M. Habliston, president; M. C. Branch, vice-president; Henry E. Litchford, vice-president and treasurer; W. H. Slaughter, secretary, and Thomas W. Purcell, assistant secretary and treasurer.

The officers of the Richmond Bank and Trust were: Henry R. Pollard, Jr., president; W. J. Whitehurst, vice-president; S. T. Beveridge, second vice-president, and Clinton L. Williams, cashier.

HIBERNIA BANK AND TRUST COMPANY JOINS FEDERAL RESERVE

The Hibernia Bank and Trust Company of New Orleans, one of the largest state banks and trust companies in the South, has become a member of the Federal Reserve System. Some of the reasons for this step were thus stated by President John J. Gannon:

"When the Federal Reserve Act first became effective three years ago we seriously considered the advisability of joining the system, but at that time con-

ditions were such that membership in the system would have interfered to some extent with the privileges which we enjoy as a state bank and trust company, and we, therefore, postponed action until a later date.

"In view of the fact that recent amendments to the Federal Reserve Act eliminated all of these obstacles, our board of directors again considered the question with the result that we filed our application for membership.

"Our primary motive in applying for membership in the system at this time is our sense of duty to our country, because we believe that under the existing extraordinary conditions it is very important that we should have a strong and unified banking system.

"The Federal Reserve System has already demonstrated its great value to our nation during the short time of its existence, but in our opinion the coöperation of the larger state banks in the reserve and central reserve cities will be necessary if the system is to become the bulwark of financial strength which it should be and which we will need to keep business on an even keel, especially for the duration of the war and the period of readjustment which will follow.

"We have felt, therefore, that by joining the system now we are in a measure enlisting our resources in the nation's cause, and are thus contributing our share to the strength and stability of the financial condition of the country.

"Another consideration which prompted us to take this step at this

The National Stock Yards National Bank

AND

The National Cattle Loan Company

ST. LOUIS NATIONAL STOCK YARDS, ILLS.

Are the largest cattle financing institution in the Eighth Federal Reserve District

WIRT WRIGHT
President

O. J. SULLIVAN
Vice-President

ROBERT D. GARVIN
Cashier

time is the fact that under the amended law we will not only retain all of our charter rights as a state bank and trust company granted under the laws of the State of Louisiana, but, in addition, we will now enjoy all of the privileges and facilities which membership in the Federal Reserve System affords.

"Among the most important of these added privileges and facilities is the right to rediscount and the consequent ability to obtain whatever amount of currency may be needed at any time. Of course, this access to the resources of the Federal Reserve System is not very important under ordinary conditions, but it becomes of inestimable value to even the strongest bank in times of financial stress.

"Moreover, New Orleans is rapidly becoming a commercial and financial centre of the first magnitude, and we believe that as members of the Federal

Reserve System we will be in a better position to give every possible assistance in the development of the commercial possibilities of this section.

"We will, of course, continue to be subject to supervision and examination of the Louisiana State Banking Department, and of the New Orleans Clearing-house Association, and in addition we will now be subject to supervision of the United States Government through the Federal Reserve Board."

VIRGINIA STATE BANKS

On June 30, 1916, the 278 incorporated state banks of Virginia reported \$69,526,047.24 total deposits and \$99,655,889.91 aggregate resources. On June 20, 1917, deposits were \$84,446,028.41—an increase of \$14,919,981.17—and aggregate resources \$117,133,554.24—an increase of \$17,477,664.33.

SEND YOUR BUSINESS

ON THE

Twin Cities AND THE Northwest

TO THE

CAPITAL AND SURPLUS
TEN MILLION DOLLARS

We are prepared to meet your most exacting requirements and cordially invite you to write to us



Is It Not Sound Policy

to send your Baltimore business to the bank whose half century of experience gives assurance of efficiency and strength?

For the handling of collections and all other banking business, this institution is admirably equipped.

Large capital, surplus and resources enable this bank to offer you complete banking facilities and services which are real and not visionary.

The National Exchange Bank Baltimore, Md.

Capital & Surplus, \$2,480,000 Resources, \$12,048,000

WALDO NEWCOMER, President

SUMMERFIELD BALDWIN, Vice-Pres.

R. VINTON LANSDALE, Cashier

CLINTON G. MORGAN, Asst. Cash.

JOSEPH W. LEFFLER, Asst. Cash.

The number of banks on June 20, 1917, was 287.

NOMINATED PRESIDENT A. B. A.

R. S. Hecht of the Hibernia Bank and Trust Company of New Orleans has accepted the nomination for the presidency of the American Institute of Banking.

NEW HOME FOR SAN ANTONIO BANK

Active work has been commenced by Hoggson Brothers on the new individual bank building which they have designed and will erect and equip for the Lockwood National Bank, San Antonio, Texas.

The building will be constructed of Bedford limestone, following in architectural design the pure Greek-Doric style, the front having four engaged Doric columns supporting a heavy Greek pediment motive. The structure will present an appearance of great dignity, strength and beauty and will

be a worthy addition to the civic development of San Antonio.

Neither expense nor effort will be spared by the bank to make its new quarters the equal of any financial institution in the South. Owing to its increasing business, the directors of the bank have arranged to provide ample accommodations not only for present needs, but to take care of future requirements.

The Lockwood National Bank was organized in 1865, and has a capital of \$200,000. Its present officers are J. Muir, president; J. D. Houston, vice-president; M. Freeborn, cashier; E. W. Richardson and T. V. Muller, assistant cashiers.

THOUGHTFUL RECOGNITION GIVEN BY
BANK TO ASSISTANT CASHIERS

The National City Bank has very graciously sent to their friends and fellow bankers a formal notice of the resignation of two of their assistant

Established
1857



60 Years of Con-
servative Banking

The
**Mechanics-American
National Bank**
of St. Louis

Capital, \$2,000,000

Surplus, \$2,500,000

Resources, \$41,426,000

▲ STRONG BANK WITH THE EQUIPMENT, THE EXPERIENCE AND
THE STRENGTH TO GIVE THE BEST SERVICE

ACCOUNTS INVITED

WALKER HILL, President

FRANK O. HICKS . . .	Vice-President	JOSEPH S. CALFEE	Cashier
JACKSON JOHNSON . . .	Vice-President	CHARLES L. ALLEN . . .	Asst. Cashier
EPHRAIM CATLIN . . .	Vice-President	JAMES R. LEAVELL . . .	Asst. Cashier
	WILLIAM H. HETTEL . . .	Asst. Cashier	

cashiers. The announcement reads as follows:

"The directors of the National City Bank of Chicago announce with regret the resignations, as assistant cashiers, of Mr. Wallace T. Perkins, who has accepted a vice-presidency of the Chatham and Phenix National Bank of New York city, and of Mr. A. Waller Morton, who becomes a partner in the firm of Babcock, Rushton & Co., of Chicago.

"They both enter upon their new duties with our best wishes.

"Mr. Lee A. King and Mr. T. R. Thorsen have been appointed assistant cashiers to succeed Messrs. Perkins and Morton, whose signatures are revoked as of August 15, 1917."

CHICAGO BANK COMMENTS ON SHIPPING CONTROL

The August business and financial letter of the National Bank of the Republic comments on the ship control as follows:

With the federal shipbuilding controversy at an end, quick action is expected in the carrying through of the government's program for the rapid production of ships to defeat the submarine menace. Although there has recently been much exaggeration of the shipping losses sustained through submarines, the total tonnage that is being sent to the bottom is greatly in excess of new ship production, which fact lends color to the statements emanating from Germany that its U-boat campaign is succeeding. Accustomed to huge and ever-growing totals in our export trade, the country at large has been prone to minimize the importance of ocean shipping in the conduct of the war. More than ever before, the war has become a war of materials, the free transport of which is of vital importance.

BANK COMMENTS ON TRADE SITUATION

Regarding the trade situation in the United States, the National City Bank of Chicago in its August financial and business letter states:

The greatest factor in the trade situation is still the prospective expenditure of ten billion dollars for war supplies for the United States and its foreign Allies. Business generally is being conducted with great efficiency and notwithstanding the enforced reduction of profits through the exactions of the price-fixing campaign, the indications are that most industries will make an excellent showing on the year's business. Manufacturers and merchants everywhere are shaping their affairs with reference to providing for the vicissitudes of a "war market" and the possibility of a peace declaration before many months have elapsed.

We Are Now a Member of the Federal Reserve System

Through our membership in the Federal Reserve System and the St. Louis Clearing House Association, complete facilities are offered Banks and Trust Companies for handling their business in St. Louis and throughout the entire Mississippi Valley, upon most favorable terms.

Complete Financial, Trust, Bond, Real Estate, Safe Deposit, Savings and Farm Loan Departments.

Correspondence Invited

Mississippi Valley Trust Co.

Capital, Surplus and Profits over \$8,000,000

ST. LOUIS



There are many uncertainties to deal with in such a situation, but the thing to remember is that the crop outlook has improved, that most of the great industries have more working capital than they ever had before and that the country as a whole is protected by the largest gold reserve that any nation ever had at this or any other season. It is evident, therefore, that war or no war the United States is about the last nation for any sane man "to go short of" at this stage of the game.

CONVENTION OF ILLINOIS BANKERS ASSOCIATION

The twenty-seventh annual convention of the Illinois Bankers Association will be held in Quincy September 18-20. The program includes addresses by F. A. Vanderlip of New York; P. W. Goebel, president of the American Bankers Association; J. H. Puelicher of Milwaukee; Joseph Chapman, vice-president of the Northwestern National Bank of Minneapolis, and Bruce Baird, who is president of the Chicago chapter of the A. I. B.

ELECTS ADDITIONAL OFFICERS

At the meeting of the board of directors of the First National Bank of

Chicago held July 31, C. V. Essroger was elected assistant cashier, succeeding the late Edward S. Thomas in division A of the bank's official organization. Richard J. Cody was elected assistant cashier, retaining supervision of the clerical and bookkeeping departments of the bank, of which he had been in charge as chief clerk. James

*foreign exchange
is the clue*

to the international situation

The unprecedented increase in our foreign trade—the unfamiliar spectacle of our becoming a creditor nation—is causing business men and students to pay more attention to the study of foreign exchange. *What is it? How does it operate? How is it affected by international transactions?* ¶ These questions and many others are answered in "The Elements of Foreign Exchange" by Franklin Escher. The intricacies and perplexities of foreign exchange are made clear in this little book, which, in a popular and readable style, tells you just what you NEED and WANT to know about this important subject. Sent prepaid anywhere on receipt of check or money order for \$1.35.

Send for our catalogue of banking books.

Bankers Publishing Company New York
253 Broadway

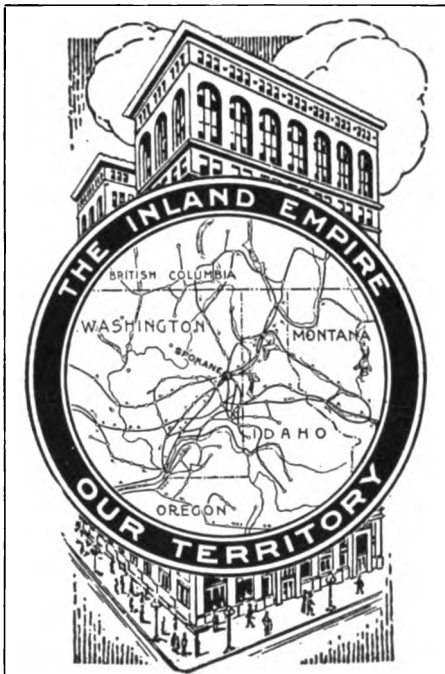

The Old National Bank of Spokane

WITH direct connections in every banking point throughout the "Inland Empire"—a region three times the size of Alabama, of which Spokane is the financial and railroad center—The Old National has the facilities to collect your Pacific Northwest items with exceptional economy and dispatch.

OFFICERS

D. W. TWOHY, President
T. J. HUMBIRD, Vice-President
W. D. VINCENT, Vice-President
J. A. YEOMANS, Cashier
W. J. SMITHSON
G. H. GREENWOOD J. W. BRADLEY
Assistant Cashiers

RESOURCES : \$20,000,000

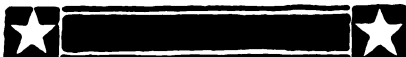

P. McManus was also elected an assistant cashier and will continue in the work of developing new business in which he has been engaged.

THE MORRIS PLAN IN CHICAGO

The Chicago Morris Plan Bank began business, informally, at 21 North La Salle street, on Friday, July 27. There were 500 callers in the course of the day, and 170 applications for loans were given out, for a total of \$36,000. The same pace was maintained on the half-day following; and on Monday, when the formal opening occurred, 398 applications for loans aggregating \$77,700 were given out.

The new bank, whose directorate comprises many of the foremost bankers and other business men of Chicago, has a cash capital of \$1,000,000. It is one of eighty-four similar institutions operating the Morris Plan in eighty-six American cities. The authorized capital of these companies is \$10,573,600, and they are lending \$2,250,000 monthly in small sums, to about 16,000 borrowers, mainly of the industrial class. To July 31 they had made over 300,000 loans, aggregating over \$40,000,000.

BANK REGISTERS TRADE MARK

The Third National Bank of St. Louis has registered in the United States patent office its trademark. It is a double eclipse with a large figure three in the middle and has been used for over a quarter of a century.

REPORTS CONDITIONS IN SOUTHWEST

The August financial digest published monthly by the Mechanics American National Bank of St. Louis, in commenting on local conditions, states:

This is the season when dullness often prevails, but the volume of business now being done by large mercantile concerns is highly encouraging. Most of the important manufacturing interests have good business in sight, but in a few lines the advance buying is not as heavy as it might be. Activity in the building industry has been restricted here as elsewhere by the high prices of material and the difficulty of securing prompt deliveries at any

price. Notwithstanding these drawbacks, however, there is more or less construction work being carried on in the residential districts. This reflects the heavy spending power of this community, which is very large, notwithstanding the high cost of living and the increased expense of doing business.

UNION-COMMERCE MERGER

The Union National Bank of St. Louis and the Bank of Commerce, National Association, will soon merge under the name of the Citizens National Bank. The new bank is to have a capital of \$3,000,000 and a surplus of \$2,000,000, and will be affiliated with the Citizens Savings and Trust Company.

DEATH OF ALEXANDER MCPHERSON

Alexander McPherson, chairman of the board of the Old Detroit National Bank, and a very widely known banker, died on July 22. Mr. McPherson was an organizer and president of the Detroit Trust Company, a member of the Detroit Board of Commerce, vice-president of the Buhl Malleable Iron Company, a director of the National Can Company, the Scotten-Dillon Company and of the State Bank of Fowlerville.

DETROIT BANK JOINS FEDERAL RESERVE

The People's State Bank of Detroit, Mich., recently by a unanimous vote of the board became a member of the Federal Reserve System. The bank has deposits of over \$67,500,000, and is one of the largest state banks in Michigan.



Why "Hospital" is in our name

THE older citizens of Providence know why the word "Hospital" occurs in our corporate name. Do you?

When this Company was chartered (1867) one of its objects was to aid the Rhode Island Hospital. A part of the annual profits went to the support of that institution. Later this arrangement was changed so that the hospital received outright a block of the Company's stock. The word "Hospital" remains in the name of the Company, a significant reminder of our honorable historic connection. We are proud of our name and are trying to live up to its spirit.

Rhode Island Hospital Trust Company
15 WATERMAN STREET, PROVIDENCE, R. I.

An advertisement

prepared by

EDWIN BIRD WILSON, Inc.

Financial Advertising

Bankers Trust Building
NEW YORK

DENVER BANK JOINS FEDERAL RESERVE

The International Trust Company of Denver, Colo., was recently admitted to the Federal Reserve System. Founded in 1892, this bank is the largest

DJÖRUP, EDWARDS & McARDLE

**Bank, Commercial, and Foreign
Exchange Audits and Systems**

42 BROADWAY **NEW YORK**

ADRIAN H. MULLER & SON

55 WILLIAM STREET, Corner of Pine Street, NEW YORK

AUCTIONEERS

The Business of Banks, Bankers, Investors and Dealers in Securities generally, receives prompt and careful attention.

STOCKS AND BONDS AT AUCTION

REGULAR AUCTION SALES OF ALL CLASSES OF STOCKS AND BONDS EVERY WEDNESDAY

Real Estate at Public and Private Sale

Prompt Returns on all business entrusted to us

state bank or trust company between the Missouri River and the Pacific coast states. It is the first state institution in Colorado and the first state institution of importance in the Rocky Mountain section to apply for admission to the Federal Reserve System. Through conservative banking methods and with the loyal support of many of

the strongest interests in Colorado, it has acquired its present position of leadership. The bank has a capital and surplus now of \$1,000,000 and deposits of over \$16,000,000. It is announced that the action of the bank in joining was prompted by patriotic reasons.

CHANGES IN OFFICERS OF SAN FRANCISCO FEDERAL RESERVE BANK

The vacancy in the governorship of the Federal Reserve Bank of San

The Bankers Service Corporation

of New York

Offers to client Banks a Service based on experience and measured by results—for the increasing of deposits.

We would welcome the opportunity of pointing out to you some truly remarkable records of growth resulting from plans devised and executed by us.

Bankers Service Corporation

258 Broadway, New York



JAMES K. LYNCH
Newly Elected Governor of the Federal Reserve
Bank of San Francisco



TRADE MARK

A New Factor in Banking

Every bank has the right to know whether the merchant or manufacturer who receives a loan is conducting a successful business based on modern methods.

This organization, through its Business Counselor Service, comes forward as a new and powerful factor in Banking. We analyze business conditions, make audits based on facts, and point the way to scientific successful administration.

Full particulars on request

The G. K. Parsons Corporation

ENGINEERS OF BUSINESS

Equitable Building

New York

San Francisco caused by the resignation of Archibald Hains, who becomes president of the new American Foreign Banking Corporation, has been filled by the election of James K. Lynch, vice-president of the First National Bank of San Francisco, and a former president of the American Bankers Association.

W. A. Day, assistant cashier of the Savings Union Bank and Trust Company, has been elected assistant deputy governor.

IRONWOOD, MICH., BANK BUILDING

The exterior of the individual building being built by Hoggson Brothers for the Gogebic National Bank of Ironwood, Mich., is sufficiently near completion to give some idea of the exceptionally fine home the bank is soon to occupy. The exterior is a massive and beautiful design of limestone and brick, carried out in the Greek Ionic order of architecture. Two stately columns with carved capitals and bases grace the front and there is a cornice and



W. A. DAY
Newly Elected Assistant Deputy Governor Federal
Reserve Bank of San Francisco



MODERN BANK BUILDING NOW UNDER CONSTRUCTION FOR THE
ROCKLAND TRUST CO., ROCKLAND, MASS.

THOMAS M. JAMES
ARCHITECT

185 DEVONSHIRE STREET,

BOSTON, MASS.

parapet, while the main entrance is dignified with a handsome carved stone pediment.

Plans for the decorations and equipment will make the interior of the structure equal to the standard set by its outward aspect.

CALIFORNIA PETROLEUM INDUSTRY

The American National Bank of San Francisco in its July 25, 1917, financial and business letter refers to the petroleum industry in California as follows:

The situation in the petroleum industry in California is the cause of considerable anxiety. During the six months ending June 30 the production for the state was 47,570,906 barrels, an average of 262,823 a day. In the same period, however, total crude oil stocks declined from 44,036,190 barrels to 37,020,263 barrels, a decrease of 7,015,927 barrels, or a daily average of 38,762 barrels. With consumption already so far ahead of production, and new consumers being added constantly, it is evident that ways must be found of bringing in new wells and increasing the supply if the industry is not to suffer through shortage of oil. The lands withdrawn by the government should be put into productive use under leasing arrangements, but even if this were done the problem of obtaining casings and other supplies would remain to be solved.

REPORTS CONDITION SAN FRANCISCO BANKS

The Anglo and London-Paris National Bank of San Francisco in its August financial and news letter re-

United States Corporation Company

65 CEDAR STREET
NEW YORK CITY

ACTS AS

Transfer Agent and Registrar

FURNISHES

Principal Offices for Corporations in all States and the Canadian Provinces

ports the condition of the banks of the city according to the call of June 20, 1917. The following figures show the gains in the city for one year less ten days:

DEPOSITS		1916	1917
Nat. banks...	\$196,087,411.62	\$242,199,486.88	
State com'l...	72,717,179.19	74,159,304.01	
Total Com'l.	\$268,804,590.81	\$316,358,790.89	
Sav. banks...	\$222,440,284.64	\$256,441,193.28	
LOANS		1916	1917
Nat. banks...	\$130,538,385.75	\$156,200,767.41	
State com'l...	34,441,069.34	45,100,554.57	
Total com'l.	\$164,980,055.09	\$201,301,321.98	
Sav. banks...	\$148,200,369.54	\$160,191,944.09	
RESOURCES		1916	1917
San Francisco			
National	\$281,444,060.98	\$326,339,071.55	
State com'l...	78,915,198.39	92,102,523.31	
Total com'l.	\$360,359,259.37	\$418,441,594.86	
Sav. banks...	\$250,826,408.67	\$278,055,649.07	

LA BANQUE NATIONALE

The last statement of La Banque Nationale with head offices in Quebec,

Unusual Conditions

Constantly they confront the banker in his business building effort.

Opportunity presents itself; passes; is followed by others.

Quick action is demanded —ACTION based upon specific knowledge.

In financial publicity timeliness is necessary as never before.

And timeliness is best assured through the services of the Staff of Financial Publicity Specialists maintained by

COLLINS PUBLICITY SERVICE
Philadelphia, Pa.

We are the Largest Manufacturers of
Home Safes and Pocket Savings Banks IN THE WORLD



Standard Oval Pocket

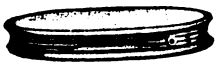

Simplex Round

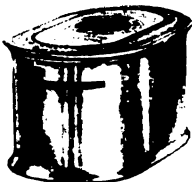

Gem Home Safe

Low in Price
High in Quality

Our Banks are endorsed by over 3,000 of the leading Banking Institutions of the United States. Write us for

FREE SAMPLES

Catalogue, illustrating our eleven different types, endorsements and plans of distribution.

NOTE:—The Standard Oval Pocket Bank holds quarters and smaller coins.

The Simplex Round Bank holds dimes. Can also be made to hold quarters and smaller coins.

The Gem Home Safe holds half dollars and smaller coins; also currency.

STRONGHART COMPANY
1510-12-14-1516 S. WABASH AVE.
CHICAGO, U. S. A.

Canada, is as of April 30, 1917, and shows total resources of \$36,596,248.42 with deposits of \$27,618,301.28. The bank has a paid-up capital of \$2,000,000 and a reserve fund of the same amount. Beginning with August dividends will be at the rate of nine per cent. This bank operates 235 branches and agencies in Canada and one in Paris.

APPOINTED EXCLUSIVE AGENTS

The American Steel Export Company has appointed Woodburn's Limited, of Montreal, Canada, as their exclusive agents for the provinces of Ontario and Quebec.

Woodburn's Limited have a close connection with many of the largest users and buyers of raw and semi-finished iron and steel and are familiar with the needs of users of all classes of me-

HYDRO-CRETE

TRADE MARK

A NEW CONCRETE FOR BANK VAULTS

PRACTICALLY

FIRE, WATER AND BURGLAR PROOF

VAULTS INSTALLED AND UNDER CONTRACT

Federal Reserve Bank	- - - -	New York City
Guaranty Trust Company	- - - -	"
Metropolitan Life Insurance Company	- - - -	"
Sixty Liberty Street Corporation	- - - -	"
Rhode Island Hospital Trust Company		Providence, R. I.

BY THE

HYDROLITHIC WATERPROOFING CO., Inc.

1328 Broadway

NEW YORK CITY

chanical equipment. They are particularly well known throughout the provinces of Ontario and Quebec and needless to say place at the disposal of Canadian consumers extensive facilities and vast sources of supplies.

CANADIAN BANKS MAKE LARGE GAINS IN DEPOSITS

The feature of the Canadian Chartered Bank's report for July was the

new high records which were established in both savings and non-interest deposits. Savings advanced by nearly \$500,000,000 and notice deposits for the first time in the history of the Dominion exceeded \$900,000,000.

Combined deposits increased by \$18,798,720 over the month of May, of which increase savings deposits accounted for \$5,849,823 and notice deposits for \$7,947,897. The nearest approach to the present high record for savings deposits this year was in the month of March when the total was \$448,151,528.

A secondary feature of the statement was the decrease in loans. Current loans in Canada for June at \$839,355,782 is a decrease of approximately \$15,500,000 from those shown in May. In call loans there is a further decrease of around \$2,500,000 in Canada and over \$9,000,000 in New York.

The central gold reserve shows a gain of over \$5,000,000 in current coin, but a decrease of over \$3,500,000 in Dominion notes.

Total liabilities showed a decrease of

Accurate News of Pacific Northwest

Have You Business or Investment Interests in Washington, Oregon, Montana, Idaho, Alaska or British Columbia?

The authoritative commercial and financial publication of this section is **BUSINESS CHRONICLE OF THE PACIFIC NORTHWEST** issued every Saturday Morning. It tells what you need to know of banking, investments, lumber, fish, apples, agricultural products, mining, foreign trade, railway and marine transportation, commercial and business affairs generally, and analyzes current progress and development. You may rely upon what you see in its columns.

Send for free sample copy. There is no paper like it anywhere.

BUSINESS CHRONICLE

EDWIN SELVIN, Editor

Alaska Building SEATTLE, U. S. A.



DEVELOPING
MAN-POWER
IN
BANKING



Some men, like machines, are replacable at cost, or less. Others are indispensable as the power which propels the modern super-dreadnought.

Modern banking needs these *power* men, men who can solve intelligently the intricate banking problems of today, who can create and develop new business, and who are capable of forming sound banking judgments. And there is a way of developing executive bankers, for the complex problems of present-day banking.

The New La Salle Course in Banking and Finance

offers for the first time, practical and fundamental training in banking—not merely for clerical work, but for the real brain work of modern banking. It makes a concrete appeal to bank officers, directors, cashiers, and bank employees, who have a spirit for the better things in banking.

A Few of the Noted Authorities in Banking and Finance Who Have Made this Course Possible

Elmer H. Youngman, Editor, The Bankers Magazine, New York City
H. Parker Willis, Ph. D., Secretary, Federal Reserve Board, Washington
George E. Roberts, National City Bank, New York City
Arthur B. Hall, A. B., Real Estate Expert, Chicago
Louis Guenther, Editor, Financial World, New York City
Frederick Vierling, Trust Officer, Mississippi Valley Trust Company, St. Louis
Edward M. Skinner, General Manager, Wilson Brothers, Chicago
William Bethke, M. A., Director, Department of Business Administration, La Salle Extension University
Samuel D. Hirschl, S. B., J. D., Member Illinois Bar, Chicago
Frederick Thulin, I.L. B., Formerly of the Union Trust Company, Chicago

O. Howard Wolfe, Cashier, Philadelphia National Bank, Philadelphia
Walter D. Moody, Managing Director, Chicago Plan Commission
R. S. White, Collection Manager, American Steel and Wire Company
C. M. Cartwright, Managing Editor Western Underwriter, Chicago
Warren F. Hickernell, A. B., Former Editor Brookmire Economic Service
Irving R. Allen, Sales and Advertising Counselor, Chicago

60-Page Book "Banking and Finance" FREE upon Request

This publication will be mailed free and post-paid to any bank officer or individual interested. It contains useful information on modern banking questions and shows clearly what this course can do for the individual or for a bank. You owe it to yourself and your business to know about this work. Write for your copy today.



Address

LaSALLE EXTENSION UNIVERSITY

"The World's Greatest Extension University"

Dept. 4312-D

Chicago, Illinois



ESTABLISHED 1865

PEIRCE SCHOOL

OF BUSINESS ADMINISTRATION

Pine Street, West of Broad

PHILADELPHIA

A Business Course, including banking, accounting, business management, commercial law and other practical subjects, which forms an admirable substitute for a college education and saves from two to three years of time.

Special Courses in banking and business administration for students who have had one or more years in college.

Secretarial Courses for those desiring to prepare themselves for secretarial work.

The school is known throughout the United States for the excellence and thoroughness of its business training. Its graduating classes have been addressed by ex-Presidents Taft, Roosevelt, Harrison and Cleveland.

One of the best school buildings in the country; large gymnasium.

Students may enter at any time during the school year.

Fifty-second Catalogue and Illustrated Booklet will be mailed upon application.

more than \$32,500,000 and the decrease in assets amounted to over \$33,000,000. Comparisons follow:

	July, '17.
Reserve funds	\$113,494,533
Note circulation	105,267,701
Demand deposits	449,689,670
Notice deposits	960,510,552
Deposits outside	177,974,187
Current coin	77,052,527
Dominion notes	122,617,160
Gold reserve	43,450,000
Call loans, Canada	76,085,220
Call loans, outside	159,309,133
Current loans, Canada	839,355,782
Current loans, outside	93,150,083
Total liabilities	\$1,790,434,357
Total assets	\$2,033,622,950

expected, will show higher average yields than for some years. In some western districts, the crops are reported

	July, '17.	May, '17.	June, '16.
Reserve funds	\$113,494,533	\$113,493,033	\$113,022,933
Note circulation	105,267,701	142,653,596	123,373,396
Demand deposits	449,689,670	443,839,847	428,117,340
Notice deposits	960,510,552	892,562,657	767,598,130
Deposits outside	177,974,187	206,682,376	176,922,950
Current coin	77,052,527	71,931,047	66,020,085
Dominion notes	122,617,160	126,238,965	142,638,872
Gold reserve	43,450,000	39,500,000	17,710,000
Call loans, Canada	76,085,220	78,514,798	86,776,474
Call loans, outside	159,309,133	168,692,675	182,757,013
Current loans, Canada	839,355,782	844,890,589	747,470,541
Current loans, outside	93,150,083	98,993,197	60,081,584
Total liabilities	\$1,790,434,357	\$1,822,959,711	\$1,598,154,315
Total assets	\$2,033,622,950	\$2,066,702,590	\$1,836,247,821

TRADE CONDITIONS IN CANADA

(From the Canadian Bank of Commerce monthly letter)

Indications are that the cereal crop of the Dominion will be quite as good, if not better, than that of a year ago. In the eastern provinces, favorable weather has resulted in satisfactory growth, and harvesting has already commenced. Threshing returns, it is fully

to be of an uneven character, but on the whole an average yield is expected.

BANKS ORGANIZED, FINANCED, BOUGHT AND SOLD, everywhere: ample funds always on hand for good new, or old dividend paying bank stocks, carrying official positions. Highest class, confidential selling and buying service rendered banks, bankers and investors. JOHN P. JONES, Monadnock Block, Chicago, Ill.

\$1,100,000
SAVED
 IN HANDLING
2,750,000,000
 POSTAGE STAMPS *through*



80% CHEAPER
 than by any
 other method

**MAN
 POWER
 SAVED**

Let Us Show YOU How To Save Money

MAIL-O-METER
 SALES COMPANY
 CHICAGO

MAIL-O-METER
 COMPANY
 DETROIT

MAIL-O-METER
 SALES COMPANY
 NEW YORK

The yield of wheat will approximate that of last year, but that of some grains will be less.

The Government has prohibited the export of the remainder of the 1916 wheat crop to the United States and has fixed a maximum price on the basis of \$2.40 for No. 1 Northern at Fort William. This maximum price is now being obtained. At the close of July the amount in terminal, interior terminal and public elevators was 11,844,303

bushels, as compared with 17,549,964 a year ago, and 2,324,881 in 1915. It has been officially announced that the Imperial authorities will provide tonnage to handle all available wheat. This will doubtless stimulate exports, which are already on a very large scale, amounting to \$244,394,586 for the twelve months ending March, as compared with \$172,896,445 and \$74,293,548, respectively, in 1916 and 1915. The value of wheat and wheat flour export-

New and Revised Edition

A Practical Work on Practical Banking **by a Practical Bank Man**

THE latest and best book
on Practical Banking
prepared by an active bank officer of wide
experience, and embodying the methods of
operation employed by the most progressive
banks. Explains in detail the actual work-
ing of each department, particular attention
being given the important subject of banking
credit.

THE PRACTICAL WORK OF A BANK

By **WILLIAM H. KNIFFIN, JR.**, Vice-President
First National Bank, Jamaica, New York City,
Author of "The Savings Bank and Its Practical
Work," "New York Savings Bank Cases," etc.

Contains seventeen chapters and over 600
pages, constituting a comprehensive and
authoritative treatment of all the phases of
bank work.

PRICE FIVE DOLLARS

Carriage Charges Prepaid

THE BANKERS PUBLISHING COMPANY

253 Broadway New York

THE SHELBURNE

Atlantic City, New Jersey

EUROPEAN PLAN EXCLUSIVELY

Situated Directly on the Beach

JACOB WEIKEL

ed was \$281,000,000, or 25 per cent. of the total exports of Canadian produce. This extraordinarily high value is due to the advance in the price, which, in the case of this grain, is 92 per cent higher than a year ago. The Index of the Department of Labour shows the following average increases in prices as compared with those of a year ago: All grains 63 per cent.; animal and meat products 15.3 per cent.; dairy products, 33 per cent.; all other foods, 44 per cent. Wheat and fresh vegetables show the greatest advances.

The value of the lumber, lath and shingles cut in 1916 was slightly less than in 1915, and amounted to \$66,072,222; of this \$58,365,349 represents lumber, of which 3,490,550 thousand feet board measure were cut as compared with 3,842,676 in 1915. In Eastern Canada the prospects for the lumber industry have been improved by the partial removal of the British embargo placed on shipments on private account. Canadian shipments are now

permitted without licenses from the British Controller of Timber Supplies, when forwarded as deck cargoes. Purchases by the Imperial authorities have been insignificant in amount. Production has been limited by the enlistment of large numbers of men in forestry battalions for service in Great Britain and France. In spite of this decided handicap, and the resulting decline in quantity, the value of the output for the current year will probably be about the same as for last year.

In British Columbia the mills continue to operate as fully as the labor supply will permit. There is some increase in the local demand arising out of the improvement in general conditions, but the prevailing activity is sustained chiefly by orders from other provinces and from abroad.

The steel and wooden craft in course of construction at the present time in British Columbia yards are valued at \$20,000,000. Among the vessels being built are two for the Dominion Govern-

Ask Your Stationer for
Bankers Linen and Bankers Linen Bond

Made in Flat Papers, Typewriter Papers and Envelopes

They are fully appreciated by the discriminating banker desiring high-grade serviceable paper for correspondence and typewriter purposes

SOLE AGENTS

F. W. ANDERSON & CO.

INCORPORATED

34 Beekman Street, New York

ment, eight for the Imperial Government, four for Norwegian shipping houses and seven wooden schooners for the lumber trade. This activity had its inception not more than a year ago and its development has had a very inspiring effect upon the business of the entire province. The traffic of the Port of Vancouver during the twelve months ending 31st March last, was the heaviest on record, the vessels entered inwards and outwards numbering 21,301, and registering 11,735,984 tons, as compared with 9,942,197 tons in 1916, and 10,347,563 tons in 1915.

The value of the exports of pulp, pulp-wood and paper for the twelve months ending 31st March was \$52,975,457 or 31.9 per cent. more than in the previous twelve months. The increase is due partly to the advance in price and partly to the increased output. In 1916, 2,833,119 cords of pulp-

wood were produced, as compared with 2,355,550 cords in 1915. A noteworthy development of the past decade has been the steady gain in the quantity of wood manufactured into pulp, while the quantity of pulp-wood exported has remained stationary.

The final returns of the British Columbia Department of Mines for the year 1916 show an output valued at \$42,290,462. Conditions were somewhat unsettled, as they have continued to be during the first half of the present year, but both the quantity and value of the output are steadily increasing. Strikes of the employees in the coal mines have been the principal drawback, but at present conditions in this respect are fairly settled, and there is reason for hope that the returns for the current year will exceed those of last year.

The Provincial Mineralogist of British Columbia says: "Had it not been that the Crow's Nest Collieries through a series of mishaps—accompanied by a serious shortage of labor due to the war, followed by a labor strike—were unable to make as large an output as expected and intended, the coal and coke production would have been much greater; but as it was, there resulted such a shortage of coke as to partially close the copper smelters, and these in turn compelled the copper mines to very much curtail their outputs. But for these untoward circumstances, it is certain that the output for 1916 would have approached the \$50,000,000 mark."

1917 Convention

American Bankers Association

Sept., 24th-29th.

First class accommodations will be at a premium. Make your reservation now

HOTEL ST. CHARLES

12 stories of solid comfort (fire proof) directly on the beach. Noted for cuisine and service. Booklet,

Newlin Haines Co.

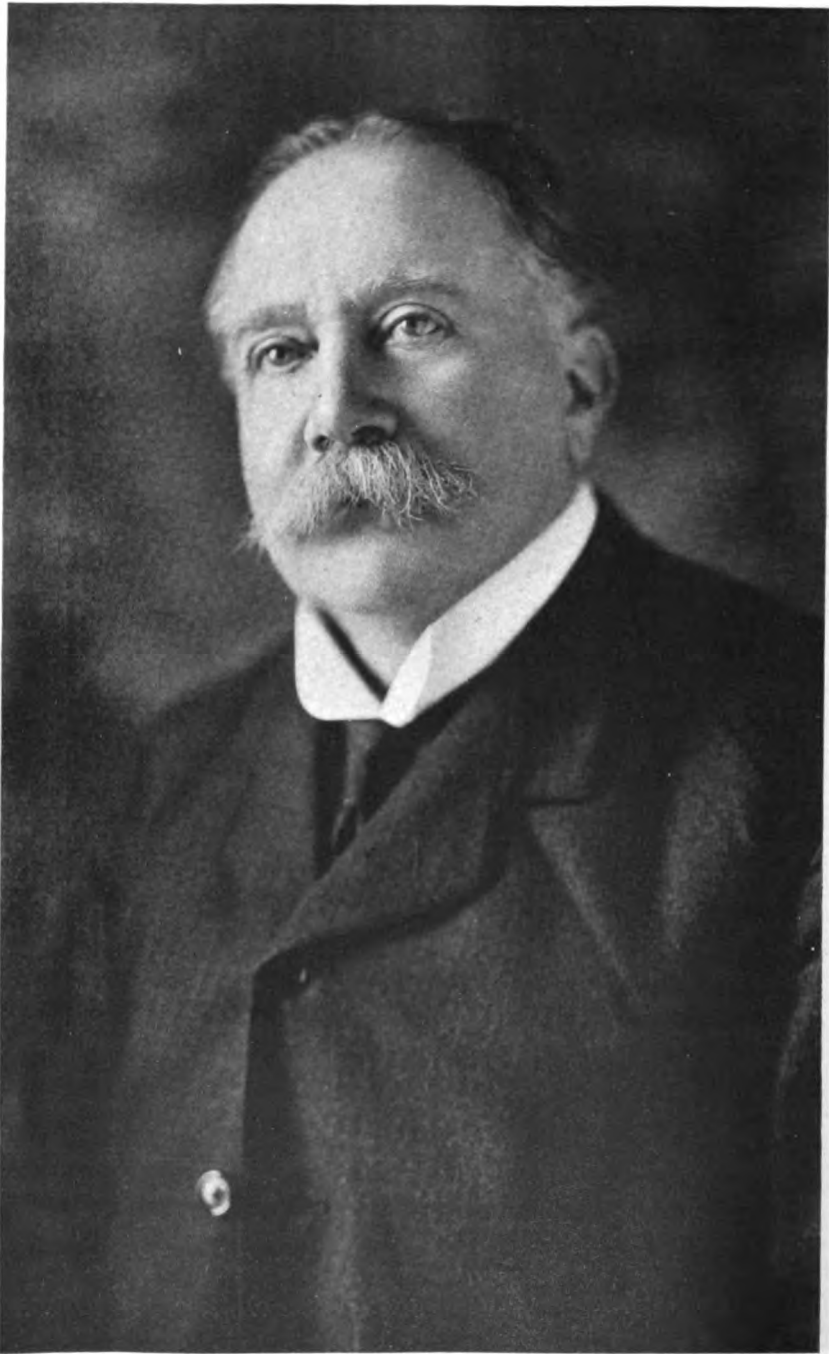

Copyright Harris & Ewing, Washington

LORD CUNLIFFE OF HEADLEY
Governor of the Bank of England

See page 476

THE BANKERS' MAGAZINE

ELMER H. YOUNGMAN, Editor

SEVENTY-FIRST YEAR

OCTOBER 1917

VOLUME XCV, NO. 4

The Bankers' Convention

CONSIDERABLE space is devoted, in a special section of this issue, to the Atlantic City convention of the American Bankers Association.

Since the meeting at Kansas City, a year ago, the country has become involved in the great European War. This convention is therefore one of the most momentous ever held. It goes without saying that the members of the American Bankers Association are enlisted in the war with all the energies and resources at their command. As President Goebel so tersely said in his annual address, "The business of this country is war." The bankers fully understand this fact, and they are so managing the funds committed to their keeping as to render their use most effective.

While the bankers are giving to the Government whole-hearted support, they will be among the happiest members of the community when the war ends with a victorious peace; for, contrary to an opinion which some seem to entertain, the bankers are not fond of war. They believe in steady, orderly progress, and not unnaturally are alarmed by the sudden upheavals which war brings. But they wish this war to end in one way, namely, by a decisive victory for our country. And the only kind of peace for which they long, or which they will even discuss, is one preceded by victory as an indispensable condition.

Properly enough, the banker has come to be one of the most respected and most trusted of any class in the community. This gives to the bankers a tremendous power in shaping public opinion, a power which is exercised in the course of the frank and friendly relations which the bankers sustain with those who deal with them.

The sentiments expressed at Atlantic City clearly show that in this great crisis in our national history the bankers have justified the public confidence in their patriotism. But far beyond words, shine the acts which the bankers have performed in sustaining the national credit and in maintaining sound and unimpaired the ordinary operations of trade in this serious emergency.

For a synopsis of what was done and said by the bankers at Atlantic City, our readers are referred to succeeding pages of this issue of THE BANKERS MAGAZINE.

A NEGLECTED OPPORTUNITY

IN recently making public the defalcation of the president of a well-known New York national bank, the Comptroller of the Currency took advantage of the opportunity to address some wise admonitions to the banks, with the aim of preventing similar defalcations in the future. All that the Comptroller says is true, and the admonitions were in all respects appropriate.

But the Comptroller did not take advantage of an obvious opportunity of stating also that the defalcation in question extended over several years, and included a period when the present occupant of the office of the Comptroller of the Currency was charged with the supervision of the national banks, and that it is a part of the duty of his office to discover infractions of the banking law such as the one under consideration.

He did take occasion to say that in previous reports he had made certain recommendations which would have tended to prevent defalcations of this kind, but neglected to say that he and his examiners, whose duty under the law it is to discover defalcations, failed in the performance of that duty.

Evidently, the Comptroller would rather tell twenty men what were good to be done than to be one of the twenty to follow his own teaching.

It is, of course, incumbent upon bank officers and directors to keep watch over the affairs of their banks, and not to rely upon the bank examiners to dig up defalcations that have been running along

for years. The bank which suffers from its own negligence can not shift the blame upon the Comptroller of the Currency and the bank examiners. It would be unreasonable to expect these officials, with their infrequent examinations and limited opportunities to discover acts of this kind which the officers of the bank had failed to find. But in a sense the examiners have an advantage in a case of this kind, where a superior officer was involved. The inferior officers come to consider anything done by a superior as beyond question. A man who is head of a great bank, and who has long held that position, grows to be an object of respect and veneration to those below him. He may do without question what would not pass muster if done by anyone else in the bank. The bank examiners, however, when they examine a bank, need be no respecter of persons. They can fearlessly challenge every transaction. This should have made it easier for them, in the present instance, to make the discovery. That they did not make it perhaps offers another example of the more or less superficial character of most official bank examinations.

When all is said, however, the fact remains that somebody must be trusted, and it is not unreasonable to expect that this person in a bank will be the superior officer. It also remains true, that in spite of the vigilance of officers and directors and of the bank examiners, occasional bank defalcations will occur.

In calling attention to this neglected opportunity on the part of the Comptroller of the Currency the object has not been to criticise that official, but merely to point out the benefits that might have accrued to the public had he taken advantage of the occasion to prescribe for himself the remedy he so confidently recommends to the bankers.

CANADIAN BANKS IN THE UNITED STATES

SEVERAL of the great chartered banks of Canada have branches in the United States, and the fact that new branches have been established here from time to time would seem to warrant the inference that the Canadian banks find in this country a profitable field for their operations.

It has been pointed out in previous issues that the banking laws of the respective states quite generally restrict the operations of branches of foreign banks to an exchange business, and to receiving funds for remittance abroad. They are, as a rule, denied the privilege of conducting a general deposit and discount business. It has been pointed out as well that when American banks, acting under authority recently given them, establish branches in foreign countries, they expect to encounter no such restriction upon their transactions, but hope to do a general banking business, including the receipt of deposits and the granting of discounts. Whether they may be granted these broad privileges in all cases, is another question.

It is at least an interesting subject of speculation to consider what will be the attitude of the Canadian banks and the Canadian Government should American banks seek to establish branches in Canada. The possibility of our banks wishing to gain a foothold in Canada is by no means a remote one, if an opinion may be ventured based upon the very close banking and business relations existing between the two countries.

The Federal Reserve Act limits the right to establish branches to national banks having \$1,000,000 capital and over. This minimum is so small compared with the average banking capital in Canada that both the Dominion Government and the Dominion banks might consider it just to exclude such banks on the grounds of insufficient capital. But quite likely, if American banks should seek hereafter to locate branches in Canada, the movement will originate with some of the very large banks in New York, Boston and Chicago to which the objection of insufficient capital would not apply.

So far as is at present known, a movement of this character is not contemplated, but in view of recent banking developments a discussion of its probability is not untimely.

The doctrine of trade reciprocity between the United States and Canada has been repudiated by the latter country. What will be the attitude of Canada should the question of banking reciprocity as above outlined become a practical matter?

It would seem desirable, in view of the growing financial importance of New York, that the present restrictions against foreign banks having branches here should be modified. This movement

might be hastened by the display of a liberal policy toward outside banks on the part of other countries.

NO DIVERSION FROM THE MAIN PURPOSE

THE chief business of the people of the United States from henceforth until their object shall be achieved consists in winning the war. From attainment of that supreme purpose no project, however alluring, should for a moment divert the energies of our people.

It was the declared aim of the German Emperor to make his troops more terrible than the Hun. In this nefarious ambition he has succeeded, and at the same time he has succeeded in uniting practically all of the civilized world against Germany. So that now the war is recognized as a conflict between civilization and barbarism. By the Emperor's words and the acts of his troops and submarine commanders, the war has been divested of all extraneous issues and made a simple clean-cut struggle between right and ruthless brute power. Not only has the German autocracy thus rendered certain the outcome of the war, but has irrevocably pronounced its own doom. Nations that have regard for their covenants and that purpose being bound by the recognized rules of civilization, will never consent to a peace with the present ruling powers in Germany. This fact was thus clearly stated for all the Allied Powers by President Wilson in his reply to the Vatican.

"We can not take the word of the present rulers of Germany as a guarantee of anything that is to endure, unless explicitly supported by such conclusive evidence of the will and purpose of the German people themselves as the other peoples of the world would be justified in accepting. Without such guarantees, treaties of settlement, agreements for disarmament, covenants to set up arbitration in the place of force, territorial adjustments, reconstitution of small nations, if made with the German Government, no man, no nation can now depend on."

Our business, then, is not to discuss any of these proposals with an irresponsible Government drunk with dreams of power, and the

authors of the horrible conditions which now exist, but to keep our minds and energies fixed upon the job in hand, which is to rid the world forever of such monsters and the ideas which they represent.

President Wilson has clearly and firmly stated our purpose, and it is the duty of every American to stand without faltering in support of that purpose.

Lord Cunliffe of Headley, Governor of the Bank of England

(From the LONDON BANKERS MAGAZINE, August, 1917)

WE have exceptional pleasure in presenting to our readers this month a recent portrait of the present Governor of the Bank of England—Lord Cunliffe of Headley. We find there is a certain coyness in Governors of the Bank of England with regard to any kind of publicity which is very hard to break down. In this matter Lord Cunliffe has certainly proved to be no exception, and it is only after many requests during the long period of his office that he has now submitted to the inevitable. Indeed, we feel that the way was, in a sense, paved for us by the almost enforced publicity to which Lord Cunliffe had to submit in his recent visit to the States, and it will be noted that the very excellent photograph which we give [see frontispiece] is the work of a Washington firm.

Speaking as we do with a knowledge of very many of those who have occupied the chair at the Bank of England during the past twenty-five years, the first comment we would make with regard to the present occupant is the exceptionally strong note of individuality which characterizes him. In one

sense, of course, it is entirely a matter of accident that Lord Cunliffe should have filled the position of Governor of the Bank for a longer period than any of his predecessors, the initial cause being that he happened to be in the chair at the outbreak of war; and the determination with which some of the original war finance problems were handled by him—to say nothing of the great complication of those problems—immediately forced upon the directors of the bank the adoption of the policy which has been so often advocated by writers on money market affairs, namely, something like continuity of management of the central institution. There are probably very few, however, who could have stood the quite abnormal strain of the responsibilities incidental to that position during the past few years, especially as it is a position which evokes daily criticism—a criticism, moreover, to which often no reply can be given, inasmuch as motives and causes actuating the policy cannot be disclosed in the midst of a great war. Indeed, it will be impossible to write a full and fair account of the part played by the Bank of Eng-

land in the crisis of the past three years until the crisis itself has passed. All the same, we believe it will not be without interest if at this juncture, and accompanying Lord Cunliffe's portrait, we give our readers a brief sketch of his career and offer a few general comments upon the policy of the bank during the past three unexampled years in the history of this country.

The grandson of one banker—James Cunliffe, of Blackburn, in Lancashire—and son of another—the late Roger Cunliffe, of Alexander Cunliffe & Co., of Lombard street—Walter Cunliffe was born in December, 1855, if not absolutely in Lancashire, of good old Lancashire stock. He was educated at Harrow, and although undistinguished as a scholar, he represented his school three times at Wimbledon in the schools' competition for the Ashburnham shield, shooting twice for the Spencer cup. From Harrow he went to Trinity College, Cambridge, and gained his "blue" in athletics, winning the inter-varsity mile in 1877. After taking his degree he travelled abroad and began life in earnest, working for a year as a stockman in Queensland, Australia. He has visited many parts of the world, either for business or sport—in fact, with the exception of South and Central Africa, there are few places which he has not seen, and many of his reminiscences of rough life in mining camps or his big game shooting expeditions are interesting.

Eventually he settled down in partnership with his brother Leonard as merchant bankers, or an accepting house, under the name of Cunliffe Brothers, which perhaps fortunately under the circumstances never aspired to doing a large business, and was one of the few of those houses who were not caught with their wings rather too far spread when the great war broke out in August, 1914.

In 1895 he was made a director of the Bank of England, and held that position until 1911, when he was elected deputy governor, in succession to Mr. A. C. Cole, who became governor.

On the outbreak of war Mr. Cunliffe, doubtless to his own consternation, found himself in the governor's chair, which he has occupied since 1913. Lord Cunliffe is now in the midst of his fifth year of office, as, so far, it has been thought desirable to make no change during the war. His only directorate is that of the North Eastern Railway Company, to which he was elected in 1905.

To recount the work of Lord Cunliffe during the three strenuous years of the war would be to fill not a short magazine article but many volumes. Each month since the outbreak of the conflict we have given in the *Bankers' Magazine* an article under the heading of "The Great Crisis," dealing with the financial developments incidental to the war, and there must be few, if any, of those developments in which Lord Cunliffe has not been directly concerned. It was at the end of 1914, and in direct recognition of the services performed to the financial community during the crisis following the outbreak of war, that he was raised to the peerage by His Majesty, on the recommendation of the ex-premier, Mr. Asquith, who, together with Mr. Lloyd George, was aware, from intimate experience, of the services which he had rendered.

It is highly interesting and somewhat instructive to think for a moment of some of the problems which have had to be dealt with during the three years by those responsible for the controlling of the banking system of the country. In the first place there was the obvious task of stemming the effects of the sudden outbreak of the European Armageddon, with its shattering effect upon the whole fabric of the international system of credit. Within the briefest space of time, arrangements had to be made at home for carrying on the banking of the country, and for providing the necessary currency requirements. Steps had to be taken to provide means for meeting the gigantic liabilities represented by outstanding

bills of exchange and also to deal with every case where the suddenness of the war occasioned temporary insolvency in directions where only time was required to liquefy frozen assets. The Stock Exchange, as we all remember, was closed, dealings in public securities on any important scale were at a standstill, and, although at the moment of the outbreak of the conflict, the trade balance was so overwhelmingly in favor of this country as to justify huge gold shipments to London, the very state of war and the consequent danger of shipping the metal, added to the many difficulties with which the country was called upon to contend. Indeed, as many writers have justly said, it was as though some great financial earthquake had occurred, interrupting completely and disorganizing for the time being the whole credit system of the world. Exceptional energy and ability were demanded, and also an unusual measure of courage. In no ordinary degree these attributes were displayed both by the then chancellor of the exchequer, Mr. Lloyd George, and by the governor of the Bank of England. Any halting measures, any lack of courage, might easily have created at that period such financial disaster as to imperil the very war itself at its commencement. But whatever minor mistakes may have been made, and it was inevitable that during a period when rapid action was the very essence of the situation, mistakes should have been made, and despite all the criticisms which have been offered at various stages of the crisis by the money market, it was at the time, and always will be, conceded that the courage and energy displayed by the governor of the Bank of England were mainly responsible for the complete absence of panic and the growing trust in the arrangements made for bridging the most difficult period of the crisis.

It will never be forgotten how, to meet the situation in the bill market and to preserve the prestige of London as a great monetary centre, bills to the extent of hundreds of millions were

discounted at the central institution under conditions which absolutely relieved all but the original parties to the bill of further liability. Moreover, it must be remembered that in those days we had not grown accustomed, as we have done since, to thinking and talking in terms of hundreds of millions, and when the financial history of the present war comes to be written, we fancy it will be generally allowed that there has been no greater example of financial courage than was then displayed in the almost prodigal liberality of the State and the bank in their arrangements for the assistance of the money market. And as on so many occasions where courage has dominated the situation, the reward of success followed, so that within a remarkably short period the chancellor of the exchequer was able to announce that the amount of undischarged liabilities to the Bank of England was really exceedingly small.

Moreover, to recall a minor but by no means unimportant incident, it is, we fancy, an open secret that it was the governor of the Bank of England who took the whole responsibility of placing a guard over the enemy banks on the 3d August, immediately after Sir Edward Grey's speech in the House of Commons, thus frustrating any attempts to remove their securities before war was actually declared.

But these were merely some of the preliminaries of the situation which had to be handled by the Bank of England at the outbreak of war. During the two and a half years considerably more than two thousand million pounds has been raised in actual long-dated loans by the Government, while if exchequer bonds and treasury bills are added the total is, of course, considerably over three thousand millions. All of these great loan flotations, though loyally participated in by the bankers in Lombard Street, have been organized and floated by the Bank of England, and so perfect has been the organization of that institution that in every case the operation has gone through with a

smoothness that has been little short of marvellous.

And yet, if the work and the problems of war finance had ended here, they might almost have been described as simple in character. But they have not. As we all know, there has been no graver aspect of war finance than that which has concerned itself with the financing of our imports from abroad. By reason of the colossal character of the war and the number of nations concerned in it, the trade balance in favor of the neutral countries, and against the belligerents, has been of a completely overwhelming character, while the burden has centered mainly upon Great Britain by reason of the extent to which, in addition to bearing her own share in the cost of the war, she has also financed a goodly part of the imports of her Allies as well. In this particular aspect of the situation the responsibilities of the Bank of England must have been stupendous, for although not defined by any Act of Parliament, it is none the less the primary responsibility of that institution to safeguard the gold supplies of this country. And yet, it is certainly no exaggeration to say that, so far as the adverse balance of trade itself was concerned, the figures were of such a character that no nation on earth could possibly have been able to control the gold position without the utmost skill and the greatest courage. Thanks, however, to concerted action on the part of the Allies and to the formation of a strong exchange committee, with Lord Cunliffe at its head, the situation has so far been dealt with in a conspicuously successful manner, although the moments of anxiety must have been frequent and great. Finally, however, as we all know, the financial arrangements pursued over a long period between America and this country became enormously strengthened by the actual entry of the States into the war, so that, so far as that country is concerned, the pressure of the problem has slightly relaxed. No small part of this problem of gold movements, how-

ever, has consisted, even in its physical aspect, of shifting the metal to the various centres required, and we believe it was largely by the ingenuity of Lord Cunliffe that at a very early stage in the war the idea was conceived of making Canada a centre first for receiving gold from New York intended for London, and later for feeding New York with gold when it became the turn of the Allies to settle their heavy indebtedness to the United States.

Moreover, throughout the whole of the war period down to the present time, it must be remembered that the Bank of England has had to fulfil the peculiarly difficult and delicate task of serving primarily and always the interests of the State, and at the same time continuing to fulfil its functions as the pivot of the money market, and to arrange matters that so far as might be possible ordinary financial business in Lombard street should continue. Under conditions such as these, it is scarcely surprising—it could hardly have been otherwise—that the one called upon to fulfil the unwelcome office of Governor of the Bank should have been exposed to constant criticisms. With a knowledge of the inwardness of events known to few, the bank's policy must often have been inspired by considerations entirely beyond the ken of the London money market, and it says much for the confidence which was inspired by Lord Cunliffe's general policy during the trying times at the beginning of the war that, despite criticism, the money market has placed increasing confidence in his judgment, even when the policy pursued has oft-times been contrary to its own immediate interests. Nor is this feeling of trust difficult to explain. It is not that mistakes may not have been committed, but in business as in other departments of life a strong leader always commands respect and confidence, and of courage and determination there has been no lack under Lord Cunliffe's governorship. There has been no task and no situation from

which he has finched, for one moment, and even some time since when, through illness, he should have been resting, he continued at his post under conditions which unquestionably involved serious risk to his health.

And now to the many services which Lord Cunliffe has already rendered to the nation must be recorded the fact that, together with our foremost statesman and diplomatist, Mr. Balfour, he took part in the mission to the United States immediately following the entry of that country into the war. By general consent that mission has come to be recognized as one of the most successful ever sent out from this country. On the political side a better choice than Mr. Balfour could not possibly have been made, and it is quite evident that his transparent sincerity made him a simply invaluable representative in clearing away any doubts, if they had previously existed, of our motives and aims in the present great war. And as regards finance, there was, of course, no one who was more intimate with every problem which has arisen since the outbreak of the war down to the present time than Lord Cunliffe, a circumstance which must have been of inestimable benefit in the many conferences on the other side of the Atlantic before the financial arrangements in connection with the granting of credits were finally concluded. Those credits so far as may be gathered have been arranged on terms thoroughly advantageous to this country, and amply reflecting the readiness of America to take its part in the war. It is well to remember, however, that where money matters are concerned, friendly sentiment in itself is not sufficient, and America was entitled to the fullest and most explicit information as to the general situation of the Allies. That the situation was adequately handled and expressed by our financial representative,

Lord Cunliffe, is sufficiently evidenced by the smoothness with which negotiations appear to have proceeded. Moreover, it must not be forgotten that, given a long continuance of the war, the monetary operations between America and this country are likely to be numerous and extensive. It seems to us, therefore, of no small advantage that the governor of the Bank of England—the first time, we imagine, that a governor has gone over in his own capacity—should himself have crossed the Atlantic and established the personal note, thus greatly assisting the further negotiations that may take place at later periods with regard to the general financial conduct of the war as affecting America and this country. Indeed, before ever America came actually into the war and before Lord Cunliffe had visited the States, a high compliment was paid both to this country and to its central institution by the fact that the Federal Reserve Board in the United States entered into arrangements for the Bank of England acting as its agent on this side of the Atlantic.

As we have already said, it will not be until after the war that the work of the Bank of England and the policy of its present head can be fairly or adequately appraised. We are still in the midst of the conflict, and possibly have yet to reach the period of greatest strain. All that has already been accomplished in the way of finance should, however, encourage hopes of a final triumph. Our own hope, and we know it is that of our readers, is that even before Lord Cunliffe vacates the chair at the Bank of England, it may be his good fortune to receive the only reward for his arduous labors for which he can possibly care, namely, the knowledge that the financial ship of State has been successfully guided through the long night of storm into smooth waters.



Enthusiasm vs. Apathy

Two Supply Depots on the Main Line to Success

By HARRY T. JONES, Chief Clerk Market and Fulton National Bank of New York

NOW and then, as we read the banking magazines, we learn that "So and So" has been promoted to the position of assistant cashier. More often we do not have to wait for the publication of the periodical, for the promotion has taken place before our very eyes. You, who have been honest, faithful, able and sincere in your work, start with others to analyze the cause of your fellow-clerk's advancement. In most cases, you ascribe it to "luck." If you will only stop to think, this is merely a subterfuge, which in itself shows that you are a poor analyst, in not delving deep enough into your subject. And yet the analysis, if one would apply the correct theories, would show the same result that we attain when analyzing the account of a depositor—whether he or it has been a source of value to the bank.

Invariably the promotion of the bank clerk to an executive position is due to nothing less than "enthusiasm." "I love my work" is a pet phrase of big business men, used as an explanation of how they managed to forge ahead and reach the top. But what was it that made them love their work? Enthusiasm is the answer. Truly, one cannot love a thing that he is not enthusiastic about. And so, in the analysis of a clerk's promotion, you must first strike that keynote of the entire situation, and learn from your deductions that the man in question surely stopped at the storehouse of "enthusiasm" to gather the fuel which would enable him to travel first-class on his journey through the banking world.

In showing how the rule of the analysis works, it is no more than fair to assume that your own position "in the rut" is not attributable to "luck." You, no doubt, have just as much brains as the other fellow, yet while his thoughts have been entirely confined to the business of banking, yours have had a tendency to run to other subjects, upon which you have displayed unlimited enthusiasm, and thereby you have become an expert in something foreign to the business world. You have devoted much time to the things that interested you, but have become apathetic to your advancement in the banking line, with the result that you have remained stationary. On the other hand, the man who was promoted chose to become interested in the banking business, devoted his time and enthusiasm to it, became an expert in his profession, and meanwhile remained apathetic to affairs which had no bearing upon his vocation.

ENTHUSIASM AND APATHY CONTRASTED

For the benefit of those who would dispute the assertion that "luck" plays no part in the promotion of the bank clerk, we can do a little analysis work right here. We will assume that two clerks in the same institution, Enthusiasm and Apathy, are subject to discussion. Enthusiasm has been with the bank only four years, and is promoted to assistant cashier. Apathy has been with the bank over twenty years, and still remains a bookkeeper. This situation exactly resembles the case of two accounts of the bank, a large one and a small one. The large account

may look very attractive on the deposit-slip, yet when analyzed found to be of less value to the bank, on account of the time-loss in realizing on the checks and the demand of interest payable for the privilege of using the certain percentage of the depositor's money, that is available. The smaller account may not have the monetary appearance on the books of the bank, that its big neighbor shows, yet it is more than possible for it to be a bigger source of profit to the bank, by reason of the fact that all the money in the smaller account is available for the bank's use, and is actually a larger sum than the percentage useful to the bank in the larger account.

Assuming then, that Apathy, in all the twenty years that he has been an employee of the bank, has done all that was assigned to him (nothing more) correctly, painstakingly and in manner satisfactory to officials, what extra percentage of his time has he given to the bank that it may use it as a source of profit in the promotion of the business? How much of his extra time can the bank realize on gratuitously, in case of emergency, or in the working out of a new system or ruling, by the powers that be, or in any of the various situations in which the bank may find itself requiring the help, assistance or suggestion of any one who cared enough about the welfare of the institution? In short, has the bank ever gotten anything from the clerk Apathy that it did not have to pay for at the normal rate?

Let us analyze the extra time of Apathy and see what it has been devoted to, also arriving at a decision as to whether the time thus employed has ever been a factor in what he so grudgingly terms, his "luck." He arrives on time in the morning and departs when his work is completed. In those hours there seems to be no apparent reason why he should display any more activity in the routine of his occupation than is necessary to accomplish his given task. He has a garden, at home, where all his extra time is exerted in the raising of things agricultural. The time,

energy and enthusiasm displayed in this direction, perhaps, have developed him into an expert in the particular line of endeavor that he is most interested in. It is even possible for Apathy to be able to devote more time to his garden than to the duties he performs at his desk in the place where he earns the wherewithal to keep his garden alive.

It will easily be seen, then, that this clerk has only given the bank a certain percentage of his time and brains, for which it has had to pay a price, reaping no harvest whatever from braininess, tact or industry displayed in the field of agriculture.

When the time arrives when the bank needs an additional assistant cashier, and the promotion of a clerk becomes imminent, is it to be assumed that the bank will take into consideration time devoted to furthering its interests; enthusiasm, ability and knowledge in projecting its ideas and policies, or will it be able to discern the capability in the man who has given all his extra time to the furtherance of ideas of gardening? The answer to this question is quite apparent to everyone, the analysis of Apathy being complete, with the simple deduction that what so many people term "luck" is nothing more nor less than the shaping of one's own resourcefulness.

Now let us proceed to analyze the time of the clerk, Enthusiasm.

His arrival at the bank has taken place long before any of the other clerks deem it advisable to put in an appearance. He is occupied with thoughts of speeding up his own work or studying methods whereby the bank may be able to save a little time, labor and money. After his given task of the day is completed, he may devote his time to the work of others, shouldering some of it himself, and at the same time developing a keenness, intuitiveness and a general knowledge of the banking business. He may even go so far as to be able to discuss, learnedly, with officers of the institution, some knotty problem that has arisen with regard to the day's business. He is

content to stay at the bank long after he is supposed to be on his way home, for this enthusiastic clerk is devoting his extra time to his bank, by thinking up new ideas to master the ever-increasing work, or he may be showing his business acumen in a hundred different ways to the end that his bank derives an extra benefit from his labors. It is plainly to be seen that this clerk is giving his regular time to his employers for a stated price and throwing in his extra time as a gratuity. But meanwhile what is happening? He is learning to become an expert in the line of his field of endeavor, and at the end of four years of hard and enthusiastic work, combined with study and ability, he has arrived. The bank is fully cognizant of the fact that Enthusiasm is an asset rather than a liability, and when the time comes for promotion, naturally chooses for an executive position the man upon whom it has realized the most, from the viewpoint of usefulness, and upon whom it can still further rely.

The clerk Enthusiasm represents, with his four years of full time, given to his bank in unlimited measure, what has been shown to have been of inestimable value; a fine investment for the bank. The clerk Apathy is shown to be only a fair investment, to say the least.

ENTHUSIASM AVAILABLE TO ALL

Enthusiasm is free to everyone; it is simply a case of whether one desires to stop at the fountain and imbibe, or whether he does not think it worth the while. There never was any contention that, individually, the bank clerk has not done a world of good, but it is almost overwhelming to think what good can be done when all work together in harmony and with enthusiasm. One must realize that no bank can expect a clerk to draw ginger ale from a fire hydrant or bring ten anywhere except between nine and eleven. At the same time, there are nine hundred and ninety-nine ways to show that you are a live wire, if the white heat of enthusiasm is inside of you.

Any bank's employees may be likened to the home team in a game of base ball, hitting the ball and running the bases to the best of their ability. The bank's officers are on the coaching line, urging us on to win the game. Every one has a chance to score, but he surely has to step up to the plate and deliver a hit, before the coacher has a chance to do his part. While awaiting your turn at bat, be a booster for your institution. A booster is one who does all the good he can, for all the people he can, in any way he can, and every time he can, with lots of enthusiasm. A knocker is a thing that hangs outside the door.



Investment Bankers Association Convention

THE possibility of a conflict in the dates of the sixth annual convention of the Investment Bankers Association of America and the campaign of the next Liberty Loan has caused the officers of the association to set November 12 as the date of its annual meeting. The convention will be held in Baltimore, but as yet the length of the session has not been decided.

"This action," stated Secretary

Frederick R. Fenton, "is taken on account of the fact that a very large proportion of our membership took a leading part in the distribution of the last Liberty Loan, and have offered their services to the Government for the distribution of the next issue, and because it seems likely that the original dates fixed for the convention might fall within the period during which the next campaign will be under way."



Direct Advertising

DIRECT advertising as a business builder is of more than ordinary importance to bankers. Within recent years a new use of this medium has come into prominence, employing it to *stimulate inactive accounts*. It is not only an effective agency for securing new business from strangers, and equally effective in work on inactive accounts, but has also great value as an agency for conserving business.

Although some bankers claim that direct advertising is the most effective medium in use to-day for reaching people in large numbers, the majority maintain that direct advertising is only a good business-builder when used in connection with other advertising mediums.

Without questioning the sincerity of those who have expressed different opinions as to the value of direct advertising, we shall consider this subject from various angles, leaving each reader to form his own conclusions as to the true value of direct advertising as a business-builder for banks, and to decide for himself how it should be used.

As long as there are different races of people, with likes and dislikes, peculiar to themselves, with vastly different social and financial conditions, it is imperative that various forms of advertising be used in order to reach them all. Direct advertising should be but one of several forms of advertising used

by our banks in connection with business building. Personally, I use direct advertising liberally, but in conjunction with other mediums. It is but one number on my program of deposit building.

PREPARATION

An essential factor in all direct advertising is a mailing list of live prospects; another factor equally as important is a message full of human interest. The safe delivery of that message to the person for whom it has been prepared is still another important factor. Unless all these elements are included in your direct advertising plan, good results are not possible.

Even before work on a list has begun, a decision should be reached as to what field a bank wishes to reach. Thousands of dollars are wasted annually in the preparation or purchase of lists of names that cannot be used to advantage; and that fact should serve as a warning, especially to beginners in direct advertising, to lay out this work before undertaking to prepare lists of names that are to comprise the bank's mailing lists. I have known banks to purchase many thousands of names, when they already had a larger mailing list than they could use effectively.

GENERAL AND SPECIAL LISTS

Direct advertising is confined to general lists of names or to lists of special classes. If confined to a general list,

the results are generally unsatisfactory. The reason for this is that any message that is made to fit a mixed class of people must deal in generalities, and therefore is too indefinite in its application to make the reader feel that it is a message to him personally. Much better results follow where direct advertising is confined to special classes. By specialization in this way, one can deliver a message which touches the personal affairs of individuals, and makes every hearer feel that you are writing confidentially to him, and to him only.

Lists of names may either be purchased from directory companies, or built up under the direction of a competent clerk in the bank. Personally, I prefer the latter method, as it invariably insures the completion of a list of names which are suited exactly to the bank's requirements.

LIVE LISTS NECESSARY

Even though great care may be exercised in checking lists, it is well-nigh impossible to keep a list up to the point where it represents live prospects only. People move from one locality to another, some die, and consequently a certain percentage of literature mailed out is certain to go astray or be returned unclaimed. No bank has the power to change this fact. Even the printing companies and bank service corporations, which advocate direct advertising as the greatest deposit-building agency, have not suggested to their clients an effective way of culling lists in order to keep only live prospects on them. About all that these specialists seem able to do in this connection is to admonish bankers that they must keep out all "dead wood" from their lists. There is not a bank in the United States that has a list of names representing live prospects only. If their lists were analyzed they would find many cases where persons had moved to other states, some of their people may perhaps have been killed on the battlefields of Europe, and others have been

dead for years; and still their names remain on lists as live prospects.

One reputable agency partial to mailing lists, advises its clients as follows: "*All the names that seem promising should be culled, and a final list made up that covers every prospect in the territory. Then your appeals would reach every person from whom there is a prospect of obtaining business; yet none of your matter would be wasted on those who have no business to give you.*"

This is good advice—but how is it to be followed?

Success in direct advertising depends to a large extent upon the ability of our bankers to maintain a live list. No bank, therefore, can afford to neglect this work. If you are unwilling to expend the time necessary to look into each case individually, it is very doubtful whether direct advertising will pay you—especially, in large cities where the population is made up of many wage earners.

ONE HUNDRED PER CENT. DELIVERY NOT POSSIBLE

The claim advanced by many enthusiastic direct advertising men, that this medium saves ammunition because it hits the target in all but a very few cases, cannot be counted upon too heavily. To illustrate: Banks in communities where the people are principally farmers, will score more hits for every hundred pieces of literature mailed, than is possible for banks in our larger cities where the population is more transient. Commenting on their success with direct advertising, a bank in a southern state says, "We have practically no letters returned by the postoffice and we have a large mailing list." What bank situated elsewhere than in a very rich farming district can say as much for direct advertising? The people in this North Carolina town are principally farmers, many of whom have lived upon farms in this vicinity for decades, and not a few of them all their life.

Very different is the case of one bank in a large city. This bank some time

ago abandoned a mailing list of 65,000 names after using it for three years. Commenting upon their experience with mailing lists, this bank writes: "We gave our lists the best possible attention both in the preparation thereof and in maintenance, and still we were unable to keep lists which might be said to contain live prospects only. At no time during the three years did we have less than two clerks employed whose duty it was to check our lists daily in order to eliminate the names of all persons known to be dead, or who had moved away or opened accounts. Notwithstanding the fact that we used great care in maintaining these lists, each time we mailed out a piece of advertising matter to the list of names, the number of returns of unclaimed literature increased.

"Just before we abandoned our lists we were receiving as returns of unclaimed letters nearly ten per cent. of all literature mailed. Confronted with the fact that one out of every ten persons was 'Not at this Number,' as was indicated by the stamp of the postoffice department, four of our regular employees were selected to go into the field, check up our lists, and make daily reports. Within thirty days these four men had gathered sufficient evidence to prove to us beyond any doubt that our direct advertising was not a success because of the disposition of the population of our city to move from place to place. Many persons had been gone for months from their old address without our knowing about their departure. In other cases, persons on our lists were dead, and some of them had been so for several years. In nearly 8,000 cases houses were found vacant, and our literature was discovered lying about on the porches crumbled and faded."

A large savings bank in Chicago writing on this subject says: "Like most people, we find it difficult to keep our mailing lists up-to-date. Out of 6,941 letters mailed, 1,750 were returned to us."

A comparison of these three cases should serve as a warning and check

the impulse to plunge into a campaign of direct advertising without studying the disposition of the people to move from place to place.

PERSONAL DELIVERY

Personal delivery of all direct advertising by bank employees, is a recent innovation. This makes possible the taking of a receipt for all literature from the person to whom it is delivered.

Any bank having a large city mailing list can well afford to use one or more of its employees to deliver its literature. Only occasionally will the expense exceed one or two cents per item, the present mailing cost. At the rate of two cents for every item delivered, an employee should be able to make good wages. Personal delivery will have the tendency to enhance the importance of the transaction in the mind of the person receiving the literature, especially if a receipt is requested.

The fact that a representative of the bank in uniform makes the delivery, insures your literature careful consideration on the part of the recipient. By this new method a bank can deliver for a price not to exceed two cents literature of any weight, for which the post-office department would charge much more. Also, the person delivering a bank's literature is placed in a position where he can check up his lists. Being in the field in person he is thrown into constant touch with the individuals themselves, and is likely to know of changes of residence, of deaths, and who are not good live prospects. Information of this sort is imperative, if a bank is to receive a maximum of results from direct advertising.

MEN, OR WOMEN?

Some bankers are meeting with great success by confining direct advertising principally to women. These banks have found that as a rule women are more susceptible to a direct appeal than are men. In the first place, direct advertising goes largely into the American home, and is delivered during the day when the mistress of the house is

usually at home, the husband being away on business. If addressed to the mistress, she is present to receive it from the postman, and not being encumbered with the cares of business she is at leisure to give the mail her undivided attention. She reads the message at once, perhaps decides to act upon it at once, and is apt to call her husband's attention to it upon his return. Thus a bank gets the attention of both by addressing its literature to women. In the American home wastebaskets are not as handy as in our offices, and for this reason also, a bank's literature will usually be placed on a mantle or a table where it will secure attention from time to time.

LETTERS VS. CIRCULARS

When a bank confines its direct advertising to circulars and booklets, thereby excluding personal letters, the results will probably be merely nominal. A personal letter is only a little less effective than a personal interview, and for this reason no bank ought to put on a campaign of direct advertising without using this highly effective weapon. Printed literature in some instances will be the means of securing new business, but generally in a limited number of cases only. If it is accompanied by a letter, much greater results are certain to follow. Although circulars have been used by banks for some years, there are still some bankers who doubt the propriety of using bright-colored circulars which border on the sensational. They lack dignity and that personal touch, both of which are necessary in order to get good results. Personally, I prefer to use a good letter in direct advertising for banks, enclosing on special occasions an appropriate piece of printed literature.

Frequently letters come to my attention which are not personal, but are circulars disguised as letters. In some letters I find the message is written in a flippant style, while others contain unnecessary slang, and still others are nothing more nor less than a "big brag" of what the bank has done, is doing,

and intends to do. Naturally, the person addressed is not interested.

THE COST

Too often bankers see only the first cost, the five cents spent for every name. As a matter of fact, this first cost is the smallest. It takes, on an average, five separate pieces of advertising matter in order to secure a remunerative number of accounts from the persons solicited.

CULLING OUT "DEAD WOOD"

At the close of business each day, compare the names of all new depositors, new borrowers, new safe deposit box renters, with all lists of prospects for business in the respective departments, cancelling from these lists the names of those who that day became patrons of one or more departments.

On these daily lists will be found the names of some who have never been solicited. These are strangers who have drifted into the bank as the result of some of its publicity work other than direct advertising. Add the names of all such persons to lists in departments where they are not patrons. To illustrate: A man opens an account to-day and it is found that his name does not appear on any of the bank's lists used in its direct advertising. Although this person is now a depositor, an investigation shows that he is not a patron of any other department. Therefore, add his name to lists of prospects in all departments except the banking department.

Each day, compare the names of depositors reopening their accounts, and cancel from the lists of closed accounts all these names. Add to this list of closed accounts the names of all depositors closing that day, and thus your record of former depositors will be kept down to date, and will always be complete.

If the bank makes a number of loans a day, it would be well to compare the names of all new borrowers daily with lists in other departments, especially noting if these new borrowers are pa-

trons of other departments. If not, add their names to the several lists, as they are good prospects for other departments.

Death notices appearing in newspapers should be consulted carefully and all names appearing thereon, which also appear on the banks lists, should be stricken from the lists.

A copy of every new city directory or telephone directory should be obtained upon publication. Copies of registers or rosters containing the names of

members of churches, lodges, social or political clubs or commercial organizations should also be obtained. These lists of names supply about the only source of information whereby a bank can successfully cull out the "dead wood" from its mailing lists, unless the bank follows the plan of delivering its literature by a representative in the field. In that case its representative would be in a position to cancel the names of all those who are no longer prospects.



Banks Aid Movement For Pure Bred Livestock

CALF and pig clubs for boys and girls have been organized through the coöperation of local bankers in five counties of New York State, according to a statement from the State College of Agriculture.

Under the plan of organization the local banks advance money for the purchase of pure bred calves or pigs, taking promissory notes from the boys and girls, who agree to care for the animals under instructions furnished by the State College of Agriculture. When the animals are sold the interest bearing notes are paid at the bank and the profits belong to the boys and girls.

Local breeders associations, farm bureaus, and other organizations are often interested in these live stock clubs and prizes and awards of merit are given at local fairs, or at the time the animals are sold, to the youngsters who have the best records in caring for their animals.

According to F. L. Griffin of the State College of Agriculture at Cornell University, who has charge of the educa-

tional side of this work, livestock projects are one of the best means of building up community interest in better live stock and of training young people to be good farmers. The bankers who coöperate in this movement feel that they are not only helping their own business but also contributing to the important work of building up the nation's food supply at a time when every effort is needed.

Among the first clubs organized in New York are: The Second National Holstein Calf Club at Elmira, Chemung county; The First National Bank Purebred Club at Cobleskill, Schoharie county, and The State Bank Calf Club of Trumansburg, Tompkins county.

Pig clubs have been organized at Middletown, Orange county, and at Waverly, Tioga county, both local banks assisting in each case.

Correspondence concerning organization and methods of starting live stock clubs should go to F. L. Griffin, College of Agriculture, Ithaca, N. Y.

Banking and Commercial Law

CASE COMMENT AND REVIEW

An Order to Buy that Proves to be a Promise to Pay

THE old trick of inducing buyers to sign an order for goods that is so worded that, by detaching a part, becomes a complete and regular promissory note, is ever with us; and many are those who have been duped thereby. An innocent purchaser of some household article signs his name to a paper without reading the fine print, assuming that having been assured by the clever salesman that he was only placing an order for the goods, subject to approval, finds to his regret that he has obligated himself to pay for something he does not want and cannot return, and bears his loss with the best grace he can muster. The sum may not be large enough to warrant legal action, and he may have neither time nor money to test his legal rights. Therefore these cases do not often come before the courts. However, there comes a time when one with fighting blood in his veins resolves to test the issue and lets the holder of the note sue. Fraud is abhorrent to the law; and a transaction tainted with deceit has no legal support. Fraud is a serious offense. It is a good defense.

In the present number we present a case where a woman signed an innocent paper which, instead of being an order, or other harmless document, turned out to be a promissory note calling for four payments of \$25 each. She thought she was signing an order for goods to be paid for as sold. Instead, she signed the above mentioned note, the order and the note being couched in such terms that upon detaching a portion, which was separated by an indistinct perforation, the promissory note was created.

The doctrine of *caveat emptor* (let

the buyer beware), or in this instance, let the signer take heed what he signs, does not obtain. A note procured in this manner is not a contract at all. There is no assent on the part of the maker to the same. It acquires no vitality.

On the other hand the fraud may consist in misrepresentation, so that the signer assents to what he is doing. He may intend to make a note, but the reasons for his intent may be brought about by false statements. A note of this character has some vitality. The minds of the parties have met. The two have agreed to the same proposition, whatever may have been the mental processes that lead up to the agreement. The circumstances of the transaction have much to do with the legal status of the case, but in this instance a milliner of limited experience was not considered as capable of reading the fine print of this contract with its legal consequences, and she was held harmless by her promise to pay. (Stevens vs. Pearson in this issue.)



When the Bank Man Holds Your Will

We have stated in this department that a national bank may do many things that would otherwise be illegal to protect itself against loss. It may run a brickyard, buy a barrel of whiskey to save itself from loss by reason of a stop payment being disregarded (holding the aforesaid whiskey for a time as a liquid asset?), take over real estate, and a multitude of other things that occur in the day's work.

Likewise it may do many things as a courtesy. It may take the trunk of a depositor and store it for the summer

in its cellar, without charge, act as intermediary in real estate transactions, and hold deeds, mortgages and other documents to be delivered upon the fulfillment of certain conditions. It may be custodian of your will.

William Perdue mailed his will to the Exchange National Bank, Spokane, Wash., in 1909. The bank acknowledged the receipt of the same. Perdue died in 1911. His heirs thought him intestate and so settled his estate. The will was delivered in 1914. Had the will been probated the plaintiff would have been entitled to \$4,000. The testator was well known to the bank officials and it was evidently a case of oversight. An injustice was obviously done the plaintiff through the bank's neglect. Was it liable? Was this a "special deposit?"

The court holds in this instance that the bank is not liable. If banks were to hold wills as a "special deposit" and become liable for all their legal possibilities of loss, they would incur liabilities of an unknown and unknowable amount, and endanger their safety as a depository of money and nullify their functions as banking institutions. It was unfortunate that the bank officers did not remember holding such a will. It was costly to the beneficiary. It was kind of the bank, but risky. It would be well if banks stuck to their knitting, for that is task enough to keep them busy. (See Myers vs. Exchange National Bank.)

Leading Cases

National Bank as Bailee of Will

WASHINGTON

Failure to Perform Voluntary Agreement to Deliver Will—Special Deposit Powers of National Banks.

Supreme Court, Washington, May 11, 1917.

MYERS VS. EXCHANGE NAT. BANK.

Where testator mailed his will to a national bank for safe-keeping in a sealed

envelope with a letter requesting the bank to hold the will subject to his order during life, and, upon satisfactory proof of his death, to deliver it to either of two parties, and the bank acknowledged receipt of the letter and sealed envelope, saying that the envelope had been filed for safe-keeping, under the terms of the letters which passed between testator and the bank there was no liability on the bank *ex contractu* or *ex delicto*, under Rem. Code 1915, sections 1289, 1292, providing that any person having custody of a will shall, within thirty days after he receives knowledge of testator's death, deliver the will into the superior court, etc., for its failure to deliver up the will.

Action by Annie Myers against the Exchange National Bank. From judgment dismissing the action, plaintiff appeals. Affirmed.

STATEMENT OF FACTS AND OPINION

Webster, J. This is an action for damages. A demurrer to the amended complaint having been sustained and the plaintiff declining to plead further, a judgment was entered dismissing the action. The plaintiff has appealed.

The essential allegations in the complaint are that the respondent is, and at all times hereafter stated was, a national bank doing business in the city of Spokane; that it has from the beginning been the custom of all banks, including the respondent, to receive and accept wills for safe-keeping, to be delivered as directed upon the death of a testator; that Enos S. Perdue, under the name of William Perdue, was for a number of years a resident of the city of Spokane, a customer of the respondent, one of its stockholders, and was well known to its officers; that in April, 1909, Perdue mailed, from the city of Los Angeles in the state of California, his last will and testament to the respondent for safekeeping, in a sealed envelope, with a letter requesting it to hold the will subject to his order during his lifetime, and, upon "satisfactory proof" of his death, to deliver it to either his friend Michael D. Shea of Spokane or a brother, William Perdue, of Glenmont, Ohio, and that respondent acknowledged receipt of the letter and sealed envelope, saying that the en-

velope had been filed for safe-keeping. It is further alleged that Shea was well known to the officers of the bank, was a resident of Spokane, and kept a place of business therein; that Perdue died in February, 1911, in the state of Ohio; that, believing Perdue died intestate, Shea, at the instance of the heirs of Perdue, was appointed administrator of his estate; that the estate was settled and distributed to the father and mother of Perdue, they being his sole heirs at law; that none of the beneficiaries under the will knew that the will existed until its delivery to Shea in October, 1914; that the respondent, through its president and other officers, had notice and knowledge of the death of Perdue pending the administration of the estate; that the appellant, under the terms of the will, would have received in excess of \$4,000 had the will been produced; that the respondent retained the will in its possession until October, 1914, when it delivered it to Shea inclosed in the sealed envelope; that the estate of Perdue had then been administered and closed and the property dissipated or lost, and that up to that date the respondent "concealed the existence" of the will from the appellant, the other beneficiaries named in the will, and from Shea and the brother, William Perdue.

The respondent demurred to the complaint upon two grounds: (1) That it does not state facts sufficient to constitute a cause of action; and (2) that the action had not been commenced within the time limited by law.

The appellant, if we correctly interpret the brief, relies: (a) Upon the contract evidenced by the two letters; and (b) upon the statute of this state. The sections of the statute relied upon are 1289 and 1292, 1 Rem. Code, which provide that any person having the custody of a will shall, within 30 days after he shall have received knowledge of the death of the testator or testatrix, deliver the will into the superior court having jurisdiction or to the person named in the will as executor, and that any person "who shall wilfully fail or neglect" to so deliver a will shall be

liable to every person interested in the will for damages by such neglect.

The respondent is a national bank, and the solution of these questions necessitates an interpretation of the National Bank Act and a review of the decisions of the federal courts. This obviously presents a federal question. The applicable provisions of this act are found in Federal Statutes Annotated, vol 5, §§ 5133, 5136, 5169, 5211, and 5228 (U. S. Comp. St. 1916, §§ 9658, 9661, 9711, 9774, 9815). Section 5133 provides that:

"Associations for carrying on the business of *banking* [italics ours] under this title may be formed by any number of natural persons, not less in any case than five."

Section 5136, subd. 7, provides that every association shall have power:

"To exercise by its board of directors, or duly authorized officers or agents, subject to law, all such incidental powers as shall be necessary to carry on the business of *banking*; by discounting and negotiating promissory notes, drafts, bills of exchange, and other evidences of debt; by receiving deposits; by buying and selling exchange, coin, and bullion; by loaning money on personal security; and by obtaining, issuing, and circulating notes according to the provisions of this title."

Section 5211 provides that every association shall make to the Comptroller of the Currency "not less than five reports" during each year; "each such report shall exhibit in detail and under appropriate heads the resources and liabilities of the association at the close of business on any past day by him specified." Section 5228 provides that in the contingencies there stated, which are not material here, it shall be lawful for the association "to deliver special deposits."

The act authorizing the creation of a bank of the United States received its first interpretation by the federal Supreme Court in the case of *McCulloch vs. Maryland*, 4 Wheat, 316, 4 L. Ed. 579. The question there presented was

whether a state could tax a branch of the Bank of the United States. In deciding that a state has no such power the court said:

"The court has bestowed on this subject its most deliberate consideration. The result is a conviction that the states have no power, by taxation or otherwise, to retard, impede, burden, or in any manner control the operations of the constitutional laws enacted by Congress to carry into execution the powers vested in the general government. This is, we think, the unavoidable consequence of that supremacy which the Constitution has declared. We are unanimously of opinion that the law passed by the Legislature of Maryland, imposing a tax on the Bank of the United States, is unconstitutional and void."

It has been held that the same rule applies to national banks. *Farmers' & Merchants' Nat. Bank vs. Dearing*, 91 U. S. 29, 23, L. Ed. 196. The reason assigned is:

"The national banks * * * are instruments designed to be used to aid the government in the administration of an important branch of the public service."

In *Easton vs. Iowa*, 188 U. S. 220, the president of a national bank was convicted and sentenced, under the provisions of a statute of the state of Iowa, for receiving a deposit at a time when he knew the bank was insolvent. In reversing the case the court said that the federal law creating and regulating national banks "has in view the erection of a system extending throughout the country, and independent, so far as powers conferred are concerned, of state legislation, which, if permitted to be applicable, might impose limitations and restrictions as various and as numerous as the states."

In *McCormick vs. Market Bank*, 165 U. S. 538, it was decided that a national bank in process of organization, but which had not been authorized by the Comptroller of the Currency to commence the business of banking, was

not liable for a breach of a five-year lease which it had executed with a view to obtaining certain offices to be used and occupied by it for banking purposes: This view was based on the provisions of the federal statute, to the effect that no such association shall transact any business "except such as is incidental and necessarily preliminary to its organization," until it has been authorized by the Comptroller to commence the business of banking. In the course of the opinion the court said:

"* * * The lease is void, cannot be made good by estoppel, and will not support an action to recover anything beyond the value of what the defendant has actually received and enjoyed."

In *California Bank vs. Kennedy*, 167 U. S. 362, 17 Sup. Ct. 831, 42 L. Ed. 198, the action was brought to recover a judgment against a national bank which had sought to subscribe for stock in a savings bank. Both banks had become insolvent. The action was based upon a statute of the state of California, on the theory that the national bank was a stockholder in the savings bank and in consequence liable under the laws of the state to pay the debts of the savings bank in proportion to the amount of stock held and owned by it. The bank had received a dividend from the state bank before the latter became insolvent. The record presented two questions:

"(1) Do the statutes of the United States (Rev. Stat. § 5136 et seq.), relating to the organization and powers of national banks, prohibit them from purchasing or subscribing to the stock of another corporation?

"(2) The transfer of the stock in question to the bank being unauthorized by law, does the fact that, under some circumstances, the bank might have legally acquired stock in the corporation estop the bank from setting up the illegality of the transaction?"

Both questions were resolved in favor of the immunity of the national bank. In deciding the first question, the court said:

"As to the first question, it is settled that the United States statutes relative to national banks constitute the measure of the authority of such corporations, and that they cannot rightfully exercise any powers except those expressly granted, or which are incidental to carrying on the business for which they are established. *Logan County Bank vs. Townsend*, 139 U. S. 67, 73. No express power to acquire the stock of another corporation is conferred upon a national bank, but it has been held that, as incidental to the power to loan money on personal security, a bank may, in the usual course of doing such business, accept stock of another corporation as collateral, and by the enforcement of its rights as pledgee it may become the owner of the collateral and be subject to liability as other stockholders. *National Bank vs. Case*, 99 U. S. 628 [25 L. Ed. 448]. So, also, a national bank may be conceded to possess the incidental power of accepting in good faith stock of another corporation as security for a previous indebtedness. It is clear, however, that a national bank does not possess the power to deal in stocks. The prohibition is implied from the failure to grant the power."

Addressing itself to the second question, it was said:

"Whatever divergence of opinion may arise on this question from conflicting adjudications in some of the state courts, in this court it is settled in favor of the right of the corporation to plead its want of power; that is to say, to assert the nullity of an act which is an ultra vires act. * * * 'A contract of a corporation, which is ultra vires, in the proper sense, that is to say, outside the object of its creation as defined in the law of its organization, and therefore beyond the powers conferred upon it by the Legislature, is not voidable only, but wholly void, and of no legal effect. The objection to the contract is, not merely that the corporation ought not to have made it, but that it could not make it. The contract cannot be ratified by either party, because it could not

have been authorized by either. No performance on either side can give the unlawful contract any validity, or be the foundation of any right of action upon it.' * * * As said in *McCormick vs. Market National Bank*, 165 U. S. 538: 'The doctrine of ultra vires, by which a contract made by a corporation beyond the scope of its corporate powers is unlawful and void and will not support an action, rests, as this court has often recognized and affirmed, upon three distinct grounds: The obligation of any one contracting with a corporation to take notice of the legal limits of its powers; the interest of the stockholders not to be subject to risks which they have never undertaken; and, above all, the interest of the public that the corporation shall not transcend the powers conferred upon it by law.' * * * Applying the principles of law thus settled to the case at bar, the result is free from doubt. The power to purchase or deal in stock of another corporation, as we have said, is not expressly conferred upon national banks, nor is it an act which may be exercised as incidental to the powers expressly conferred. A dealing in stocks is consequently an ultra vires act. Being such, it is without efficacy. *Pearce vs. Railroad Co.*, 21 How. 441, 445 [16 L. Ed. 184]. Stock so acquired creates no liability to the creditors of the corporation whose stock was attempted to be transferred. *Cook on Stock and Stockholders*, vol. 1, p. 435, note 1 to section 316, and authorities there cited."

It was further held that the bank was not estopped from questioning its ownership of stock and consequent liability because of its receipt of dividends on the stock of the savings bank.

The same principles were announced in *Concord First Ntl. Bank vs. Hawkins*, 174 U. S. 364, where a receiver of an insolvent national bank sought to enforce a stockholder's liability against another national bank which, prior to its insolvency, had purchased of a third party, with a portion of its surplus funds, a number of shares of stock of the insolvent bank as an investment. In

meeting an argument that the liability was not contractual, but statutory, the court said:

"In the present case it is sought to escape the force of these decisions by the contention that the liability of the stockholder in a national bank to respond to an assessment in case of insolvency is not contractual, but statutory. Undoubtedly, the obligation is declared by the statute to attach to the ownership of the stock, and in that sense may be said to be statutory. But as the ownership of the stock, in most cases, arises from the voluntary act of the stockholder, he must be regarded as having agreed or contracted to be subject to the obligation. However, whether in the case of persons *sui juris*, this liability is to be regarded as a contractual incident to the ownership of the stock, or as a statutory obligation, does not seem to present a practical question in the present case."

Merchants' National Bank vs. Wehrmann, 202 U. S. 295, had its origin in a bill for the dissolution of a partnership, a receiver, and an account. The partnership was formed to purchase, improve, divide into lots, and sell a lease-hold. The *Merchants' National Bank* took nine shares as security for a debt, and afterwards became the owner of them in satisfaction of the debt. It developed that a contribution was required to pay the debts of the firm. Some of the parties being insolvent, the bank was charged with the full share of an insolvent partner. Differentiating between a corporation and a partnership, the court said:

"But when a similar transfer is made of a share in a partnership it means that the transferee at once becomes a member of the firm and goes into its business with an unlimited personal liability, in short, does precisely what a national bank has no authority to do. * * * As the bank was not estopped by its dealings to deny that it was a partner, it was not estopped to deny all liability for partnership debts."

In *First Ntl. Bank of Ottawa vs. Converse*, 200 U. S. 425, it was decided

that a national bank cannot take stock in a new speculative corporation with the common double liability in satisfaction of a debt. In *Farmers & Merchants' Ntl. Bank vs. Smith*, 77 Fed. 129, it was held that the bank was not liable upon its guaranty of a mortgage bond which it had sold on commission as a broker, because the brokerage business was not within the legitimate sphere of banking. In *Bowen vs. National Bank*, 94 Fed. 925, 36 C. C. A. 553, it was held that the bank was not liable on its engagement to pay debts of a third person when such person had no funds on deposit, a fact known to both the plaintiff and the bank. The case was complicated by the fact that the plaintiff relied upon the guaranty and cashed the checks on the faith thereof. The court said there was in the federal act authorizing the creation of national banks "no grant of power to guarantee the debt of another, nor can such guaranty be said to be incidental to the business of banking." It is important to bear in mind that neither of these cases presented the question of a guaranty upon an indorsement of commercial paper taken in the ordinary course of banking and rediscounted.

Commercial Ntl. Bank vs. Pirie, 82 Fed. 799, 27 C. C. A. 171, voices the same principle. In *Cooper vs. Hill*, 94 Fed. 582, 36 C. C. A. 402, it was held that a national bank which has lawfully acquired a mining property has implied authority to pump the water out of the shafts and drifts to put it in a condition in which it could be examined by a purchaser, but that it has no authority, when no purchaser was found, to expend money in prospecting for paying ore upon the property in which none had ever been discovered. In *Hotchkin vs. Third Ntl. Bank*, 219 Mass. 234, 106 N. E. 974, it was held that the bank was not liable in damages for the breach of an executory contract to sell and deliver shares of the capital stock in another corporation, which it did not have, but which belonged to a client whom it sought to represent. The court distinguished between stock ac-

quired by a national bank in payment or in satisfaction of a loan and the buying and selling of stocks as a source of revenue or profit.

In support of the theory that the will was a special deposit within the meaning of National Bank Act, § 5228, supra, the appellant has cited *National Bank vs. Graham*, 100 U. S. 699, 25 L. Ed. 750. In that case a national bank received for safe-keeping certain government bonds, which the jury found were lost by the gross negligence of the bank or its officers, and returned a verdict for the depositor for the value of the bonds. It was held that National Bank Act, § 5228, supra, authorized National banks to deliver "special deposits," implying clearly that a national bank as a part of its legitimate business may receive such "special deposits," and that the phrase "special deposits" thus used embraces deposits such as that here in question.

Among other cases cited by the court to sustain its view is *Foster vs. Essex Bank*, 17 Mass. 479, 9 Am. Dec. 168. In that case the special deposit was a cask containing gold. Quoting from *Pattison vs. Syracuse Ntl. Bank*, 80 N. Y. 82, it was said:

"A reference to the history of banking discloses that the chief, and in some cases the only, deposits received by the early banks were special deposits of money, bullion, plate, etc., for safe-keeping, to be specifically returned to the depositor; that such was the character of the business done by the Bank of Venice (the earliest bank) and the old Bank of Amsterdam, and that the same business was done by the Goldsmiths of London and the Bank of England, and we know of none of the earlier banks where it was not done."

In *American Ntl. Bank vs. E. W. Adams & Co.*, 44 Okl. 129, it was held that a stock of shoes was not a special deposit within the meaning of the National Bank Act. In that case the shoes were received by the bank as a special deposit, and stored in a room under its control and adjoining its office.

There is a wide hiatus between a cask containing gold, coin, money, bullion, and plate and a stock of shoes. No case has been cited in which a federal court has held anything to be a special deposit except something having an intrinsic value. In *National Bank vs. Graham*, the court adverted to the fact that the cashier of the bank cut the coupons from the bonds and placed the proceeds to the credit of the depositor.

Section 5136 and 5228 of the National Bank Act should be read and construed together. It must be kept in mind that national banks can only be incorporated to carry on the business of banking. Section 5136, subd. 7, defines the manner in which banking shall be carried on; that is:

"By discounting and negotiating promissory notes, drafts, bills of exchange, and other evidences of debt; by receiving deposits; by buying and selling exchange, coin, and bullion; by loaning money on personal security; and by obtaining, issuing, and circulating notes according to the provisions of this title."

The words in this section "by receiving deposits" and the words "special deposits" in section 5228 mean substantially the same thing, viz. that the deposit must be such as is fairly embraced in the "business of banking." The meaning is made clear in *California Bank vs. Kennedy*, supra, where it is said that the statute relative to national banks constitutes "the measure of the authority of such corporation," and that they cannot rightfully exercise any powers except those specially granted, or which are incidental to the carrying on of business for which they are established. The right to receive deposits is expressly granted. The right to receive special deposits is impliedly granted, but these special deposits must be incidental to the business of banking.

The purpose of the National Bank Act is twofold: First, the bank is an agency of the federal government to aid it in carrying out its enumerated powers; second, the bank is designed to afford a safe means of doing business.

The act confers large powers upon the Comptroller of the Currency in aid of the accomplishment of both of these ends. It provides many checks and balances. The bank is required to make frequent reports to the Comptroller. Each report must exhibit in detail "the resources and liabilities" of the association. If a national bank may be permitted to hold a will for safe-keeping for one of its customers, it may do so for all. It is obvious that a large city bank might thus become the custodian of many hundreds of wills. If liable at all in consequence of such holding, there might arise many large obligations which would not appear in the report to the Comptroller and of which he would have no knowledge, thus nullifying at least some of the safeguards of the statute.

It is alleged in the complaint that it has been the custom of the respondent to receive wills for safe-keeping. Language may be found in *National Bank vs. Graham* which would impose a liability upon the bank under this allegation, but we think this case is modified by the later opinions of the federal Supreme Court which we have received. The view of the later cases is that the power to receive such a deposit must be expressly granted or fairly implied. It is elementary that no rights can spring from a customer that violates a law. *Paul vs. Seattle*, 40 Wash. 294, 82 Pac. 601.

Is the respondent liable under our statute? We have determined that there is no liability upon the respondent, either *ex contractu* or *ex delicto*, under the terms of the letters which passed between the respondent and *Perdue*. It is equally plain that, under the federal decisions which we have reviewed, the state cannot impose any liability upon a national bank by adding any powers to those expressly granted or fairly implied in the act authorizing its creation. There is another reason why the appellant cannot recover under our statute. The decree of distribution in the administration of the *Perdue* estate was entered on the 23d day of July, 1912.

This action was commenced in October, 1915, more than three years after the last act in the administration of the *Perdue* estate was performed. Then, if at all, the cause of action arose. An action upon the statute for a penalty must be commenced within three years from the date the cause of action arose. 1 Rem. Code, § 159, subd. 6. The cause of action, if any, is under this section, and not under subdivision 4, "an action for relief upon the ground of fraud." This view is supported by the recent decisions of this court: *Thomas vs. Richter*, 88 Wash. 451, *Golden Eagle Min. Co. vs. Imperator-Quilp Co.*, 161 Pac. 848; *Cornell vs. Edsen*, 78 Wash. 662.

It is argued by the respondent that the cause of action arose, if at all, at the time the property was appraised, in view of the fact that the respondent's president was one of the appraisers, and that this fact is relied upon by the appellant as showing the knowledge of the bank of the death of *Perdue*. We need not decide whether this date or the date of final settlement and distribution of the estate controls, as the statute operates as a bar in either case.

The judgment is affirmed.

164 Pac. Rep. 951.



Note Obtained by Fraud

MINNESOTA

Supreme Court, Minnesota, July 20, 1917.

STEVENS VS. PEARSON.

Defendant gave to the Donald-Richard Company an order in writing for certain goods and at the same time signed a promissory note at the bottom of the order, detachable from the order by an indistinct perforation. It is virtually conceded that the note was procured by fraud. Plaintiff is an indorsee of the note. There is evidence sufficient to sustain a finding that plaintiff was chargeable with notice of the fraud and that defendant was not negligent in signing the note.

Action by Fred L. Stevens against Bessie Pearson. There was a verdict

for defendant, and a new trial being denied, plaintiff appeals. Order affirmed.

STATEMENT OF FACT AND OPINION

Hallam, J. Plaintiff brings this action as indorsee of a "detached" note given by defendant to the Donald-Richard Company. The note was dated July 27, 1915, was payable in installments of \$25 each in four, six, eight, and ten months after date, and was indorsed over to plaintiff under date of October 13, 1915. Defendant contends that the note was obtained by fraud of one Hussey, the agent of the Donald-Richard Company, and it is conceded that if Hussey "made the representations that defendant claims were made to her, then he practiced fraud upon her" and defendant "would not be liable to the Donald-Richard Company." That he did make the representations claimed by defendant is not denied.

This leaves only the question whether, under the negotiable instrument law, plaintiff has a better right of recovery than his transferror.

Fraud, in procurement of a signature to a promissory note, may consist of a trick or artifice by which a person is induced to sign the note without knowledge of the fact that it is a note, as where the paper is folded in such manner as to conceal its true nature. A note procured by fraud of this character is not a contract at all, for there is no real assent on the part of the signer and it is wholly void and acquires no vitality, even in the hands of an innocent purchaser for value, unless the signer is guilty of some negligence, and in such event the liability to the innocent purchaser is predicted on negligence or estoppel and not on original assent. This is common law doctrine. G. S. 1913, § 6015, embodies this doctrine and perhaps enlarges it.

On the other hand, fraud may consist of misrepresentation which induces a real assent to the note, so that the party understands that he is signing just the contract that he does sign. A note obtained by fraud of this character

has some vitality. There has been a meeting of the minds. The note is subject to the defense of fraud, but it is voidable only. In the hands of a bona fide holder for value the defense of fraud is not available. In an action on a note so procured, the question of negligence is not an element.

The court instructed the jury, in substance, that section 6015 of the statute applied to this case, that though defendant proved the fraud alleged, still if she was negligent in signing this paper she had no defense against plaintiff, and then also instructed them that in no event was the defense of fraud available if plaintiff took the paper without notice or knowledge of the fraud.

This was perhaps a more favorable instruction than plaintiff was entitled to. It was if the evidence brought the case within the statute for in such case, in the absence of negligence of the signer the bona fides of the holder does not avail him. But this fact is not of great importance on this appeal, for whatever may be said of the character of the fraud in this case, we are of the opinion that the evidence is sufficient to sustain a finding that plaintiff was chargeable with notice of the fraud and that defendant was not negligent.

The fraud charged was that Hussey induced defendant, who is a milliner conducting a small store, to order a line of toilet articles with the understanding that she was to pay for them only as sold, and if they did not sell or were not satisfactory, the company would take them back, and that Hussey induced defendant to sign what was apparently only an order, but which in fact was an order with a note at the bottom with the paper perforated in such a way that the note could be detached.

It would be uncharitable to Hussey to charge the fraud wholly or even mainly to him. The whole framework of the document presented to defendant to sign was manifestly designed to enable agents to perpetrate the very fraud which Hussey in fact committed. The contract is long, on a large yellow sheet, and in fine print. Conspicuous at the

start is this "special agreement" of the seller:

"We hereby agree to buy back at the purchase price all of the goods in this order remaining on hand at the termination of this agreement, if purchaser so desires."

The time of termination of the agreement is not fixed. Hussey paraphrased this language but very little. The document is on its face designated an "order" for goods subject to "approval" of the seller. It fixes the terms of payment at four, six, eight, and ten months and gives "privilege of cash discount" of 6 per cent. on maturity of first payment. It is at the bottom of this that the instrument in form a promissory note is found. It is part of the sheet on which the order is printed and is separated from it by means of an indistinct perforation. On casual inspection it might look more like a continuation of the contract and a specification of the terms of payment under it, than a promissory note. Just above the "perforation" in the fine print is the language "the attached note is tendered in settlement of this order and the company is authorized to detach same when this order is approved and shipped." The places intended for signature are such as to confuse. Defendant's name appears twice at the foot of the order, once written by herself, once by another, as well as at the bottom of the note.

If the whole of the yellow sheet is read closely it will be seen that the detachable portion is a promissory note, but it will be seen also that the note is out of harmony with the rest of the "order," so much so that one who had made the agreement would hardly give such a note except by inadvertence, and so much so that, if this action had been brought by the payee, the defense that defendant had not sold the articles and desired to return them would be perfectly available. The value of the note is accordingly largely in its detachment and transfer. The form of the document is well calculated to aid a salesman in securing from a customer a

promissory note which he does not consciously give. In fact, it is not easy to see any purpose in incorporating this detachable note into the contract, except a purpose to deceive.

Plaintiff was a lawyer of many years' experience. He had taken thousands of dollars worth of these notes before. He knew they were detached from contracts. The taking of these notes was regular business with him, and as they were collected, the proceeds were deposited in a special fund and this fund he used to take over more notes. He left the notes in the hands of the company's attorney for collection. There had been a considerable number of suits. The company paid all expense of collection and of the litigation incident to it.

Fraud in the inception of the note having been proved, it rested with the plaintiff to prove that he was a purchaser in good faith and for value. G. S. 1913, section 5871; *Bank of Montreal vs. Beecher*, 133 Minn. 81. We think the evidence presents facts abundantly sufficient to put plaintiff on inquiry and to charge him with notice of the fraud perpetrated on defendant.

As to the alleged negligence of defendant in signing her name to this note, we need only say that we think the average intelligent milliner of small business experience, with this document before her, complicated and contradictory in its terms, would find difficulty in understanding its legal effect and might easily be led into signing her name, as defendant did, without realizing that she was putting afloat a negotiable promissory note. The books abound in cases where courts have relieved parties from the terms or provisions of contracts which by reason of fine print or other device are easily susceptible of being overlooked or not understood by the party bound by them. *Insurance Co. vs. Slaughter*, 12 Wall, 404, 20 L. Ed. 444; *Blossom vs. Dodd*, 43 N. Y. 264, 3 Am. Rep. 701. Caution should be exercised in affording such relief, but we think the evidence in this case is such that the jury might find that defendant was not negligent in

signing this note and that she was not bound by it.

Order affirmed.

(163 N. W. Rep. 769.)



Overdrafts

KANSAS

Ultra Vires Consideration.

Supreme Court of Kansas, Jan. 6, 1917.

SAYLORS VS. STATE BANK OF ALLEN.

It is not ultra vires for a bank to agree to honor overdraft checks for a regular customer.

When an agreement has been effected whereby certain profits and advantages have been procured by a banking corporation, a defense that the contract was ultra vires will not be countenanced to permit the bank to avoid its undertaking pursuant to such contract.

The president of a bank made an agreement with a stock buyer whereby the latter was to purchase live stock and ship them to market and pay for them by drawing checks on the bank. The bank agreed to pay these checks, and was to receive \$3 per carload of the live stock thus bought and shipped, and 8 per cent. interest on the money used in this business. The returns from the shipments were made to the bank, and the stock buyer's account was credited from time to time with the net proceeds. *Held*, that the bank cannot avoid its liability to pay a check, given in payment of cattle purchased by the stock buyer pursuant to such agreement.

(163 Pac. Rep.)

Action by T. M. Saylor against the State Bank of Allen and others. From a judgment for plaintiff, the defendant bank appeals. Affirmed.

STATEMENT OF FACT AND OPINION.

Dawson, J. The State Bank of Allen appeals from a judgment in which it was held liable to the face value of a check drawn by a customer of the bank in favor of the plaintiff, and which the bank declined to pay. The circumstances which were held to subject the bank to liability on the check may be

briefly stated: The village of Allen is situated in a stock-raising district in the northern part of Lyon county. A man by the name of Kelly was one of the local stock buyers. He needed funds with which to do business, and some years ago Kelly and William Hood, president of the bank of Allen, made an oral agreement by which Kelly was to go about the community purchasing live stock, and that he should issue checks on the bank of Allen in payment therefor, and the bank agreed to honor Kelly's checks thus drawn. The cattle were to be shipped to the Kansas City live stock market, and the net proceeds to be credited to Kelly's account, less interest at 8 per cent. on the sums of money thus used by Kelly, and less also the sum of \$3 per car of live stock which the bank should receive for financing Kelly's transactions. Pursuant to this arrangement Kelly prosecuted the business of stock buying throughout that community for several years. The bank honored his checks, and usually, but not invariably, exacted its toll of \$3 per car. It does not appear that it regularly or rigidly exacted interest on Kelly's overdrafts, but it always paid his checks according to their mutual understanding, except the check which is the subject of this lawsuit.

It appears that in 1915 the bank commissioner began to object to the bank's method of transacting business with Kelly, and some slight changes were made in their mode of doing business. Thereafter the cattle were shipped to Kansas City in the name of William Hood, president of the bank; and at one time Hood personally loaned Kelly \$1,000 to extinguish his overdraft and to give him some working capital. In a further effort to satisfy the bank commissioner, the bills of lading for the cattle shipped to Kansas City were attached to sight drafts drawn on the Kansas City consignee for the approximate value of the live stock shipments, and Kelly was immediately credited by the bank with the sum of each sight draft thus drawn, so that under the new mode of bookkeeping between Kelly and the bank, his over-

drafts would not be so large, nor so common, nor continue for several days at a time as was the case when the bank merely carried Kelly's overdrafts until the return on the shipments arrived from Kansas City. Kelly did not prosper in his stock buying business, although it aggregated over \$400,000 in volume during the years when the bank thus financed his transactions. When his cattle sales in Kansas City did not show a profit, the bank did not exact its share of \$3 per car. One time the president of the bank told Kelly that he was paying too much for cattle, and Kelly asked him: "Are you going to quit me?" Hood replied: "No; I will not quit you." Kelly said: "Whenever you get ready to quit, let me know in time, so I can quit clear with the people." Hood said: "I will give you plenty of time, we ain't going to quit you."

Thus the relations of Kelly and the bank continued until August, 1915, when Kelly bought 27 cattle from the plaintiff and gave his check for \$1,880 on the Bank of Allen in payment therefor in the usual manner. The cattle, or most of them, were shipped to Kansas City in the name of William Hood, president of the bank, in the usual manner. Some of plaintiff's cattle were traded for others which were shipped in their stead. The plaintiff deposited the check in an Emporia bank, and in due course it was presented to the defendant bank, where it was dishonored and protested. The bank informed the plaintiff that Kelly's balance in the bank at that time was \$905.78, and that if plaintiff would procure a check from Kelly for that sum it would pay it. The plaintiff declined, and, having learned later of the arrangement outlined above, he brought this action against Kelly and the bank, and recovered judgment for the full amount and interest.

The bank appeals, and assigns error: (1) The bank's arrangement to pay Kelly's checks was ultra vires and void; (2) no consideration; (3) incompetent evidence; (4) instructions given and refused; (5) that the special findings entitled defendant to judgment.

There is not much merit in the con-

tention that the bank's arrangement to pay Kelly's checks was ultra vires and void. Certainly the statute (Gen. Stat. 1909, section 498) which provides that the officer of a bank who pays out the bank's funds on an overdraft is himself personally liable to the bank for such payment does not so declare. That statute simply adds an additional security to the bank for such payments. Chapter 88 of the Laws of 1915, which forbids banks to engage in trade or commerce, does not cover such transactions as those of Kelly and the bank. The bank was not buying and selling live stock. It was furnishing funds—loaning money—to Kelly to engage in this business, and this is one of the principal legitimate functions of banking. We do not understand that even the federal law or its administration puts an absolute ban on overdrafts. And the state bank commissioner's circular letter, announcing his intention to cooperate with the Comptroller of the Currency to restrict the allowance of overdrafts, says:

"In future, no overdraft will be allowed with the consent of this department, and if upon any report or examination of any state bank operating under the laws of this state, it is disclosed that any overdraft or cash item has been allowed to continue for a period of ten days, such fact shall be considered evidence of unwise management and shall necessitate more frequent examinations.

"After March 1, 1915, any overdrafts or cash item that have been carried for ten days must be immediately charged from the bank's assets."

It is obvious from the paragraphs just quoted that, by the operative interpretations of the chief officer administering our state banking law, overdrafts are not illegal, for certainly the bank commissioner did not thus intend to countenance infractions of a positive statute for intervals of less than ten days. The restriction and discouragement of overdrafts is wise supervision of banking and wise bank management, and ordinarily they are only to be tolerated when practiced with great pru-

dence and within narrow limits (Laws 1915, c. 92), but their absolute prohibition must await further action by the Legislature; and an undertaking by a bank to honor an overdraft by paying the check of a regular customer of the bank for a purchase of cattle which are assigned to the president of the bank, and the proceeds of the sale of which are handled by the bank for its protection, cannot be avoided on a specious plea of *ultra vires*, nor by the fact that the bank commissioner disapproves the practice of allowing overdrafts. The prudence, or lack of prudence, in the conduct of the bank concerns the bank commissioner, and the officers, stockholders, and depositors of the bank. But the bank's agreement to furnish funds to its customer, Kelly, for legitimate business concerns those for whose benefit the agreement was made, and the plaintiff was one of the latter. *Anthony vs. Herman*, 14 Kan. 494; *Ballard vs. Bank*, 91 Kan. 91; *Norman vs. Rullman*, 93 Kan. 791; *Bank of Garnett vs. Cramer*, 7 Kan. App. 461; *German Nat. Bank vs. Grinstead*, 21 Ky. Law Rep. 674.

Viewing this question from another angle, it should be noted that, pursuant to the arrangement between Kelly and the bank by which Kelly's checks were to be honored, the title to plaintiff's cattle passed to the president of the bank, and they were shipped in the latter's name to Kansas City, and the proceeds thereof went to swell the bank's assets—to meet Kelly's checks, of course—but nevertheless they became assets of the bank. In such a situation, the bank could not escape its obligation to pay Kelly's check for plaintiff's cattle, even if its agreement with Kelly was *ultra vires*. In *Cooper vs. National Bank*, 40 Kan. 5, it was said:

"It is claimed that because the defendant is a national bank, it had no right to take this property and agree to turn back the proceeds to plaintiff, and that the cashier, in making this agreement, exceeded his authority. The bank took the property to secure its own claim; it was all personal property, and was not of more than twice the

value of the claim to be secured; it received the property, secured its own claim, and then refused to account for the balance. We think if it had the power to take the property and secure its own claim, it ought to have power to pay back the balance to plaintiff. It would be a very strange proposition of law for the bank to receive property upon a chattel mortgage or an agreement to secure its own claim, and not be compelled to account for any balance remaining after its own claim was satisfied."

The case of *Ballard vs. Bank*, 91 Kan. 91, 97, is not altogether like the present case, but is pertinent on the question of *ultra vires*, where it is said:

"It is suggested that the making of such an agreement was beyond the power of the president of a national bank, or of the bank itself. The contract was not immoral or forbidden, and even if when made it was invalid for want of capacity on the part of the officer or of the bank, it was so far carried out that a defense on that ground cannot successfully be interposed. See cases cited in *Harris vs. Gas Co.*, 76 Kan. 750, 92 Pac. 1123.

To summarize this phase of the case, the arrangement between Kelly and the bank was not illegal, though the statute fixes a personal liability on bank officers who pay overdrafts, nor although the bank commissioner requires overdrafts of more than ten days' duration to be charged off. And if an agreement to pay overdrafts was *ultra vires*, the bank could not avoid its agreement to pay them when it had appropriated the consideration for the overdraft checks issued pursuant to such agreement.

The contention that there was no consideration for the bank's agreement to pay Kelly's checks needs little discussion. It was to receive \$3 per car for all live stock purchased and shipped by Kelly pursuant to the understanding between Kelly and the bank. That it did not always exact that sum is immaterial. It exacted that sum on about 350 carloads. Kelly transacted about \$400,000 worth of business through the bank as a result of this arrangement.

Such extensive dealings might well tend to stimulate and develop the bank's general business. These considerations were sufficient. Moreover, the president of the bank took title to the cattle acquired from plaintiff, and the bank kept control of the proceeds of the cattle within its own hands. This was another sufficient consideration.

The evidence to which defendant objects reads:

"Q. Mr. Kelly, I wish you would state to the jury whether the agreement that you testified to yesterday, as having been made with the bank, in January, 1909, was ever changed or modified in substance? (The defendant objected to the question for the reason that it called for a conclusion of the witness, and not a statement of a fact, and is incompetent, irrelevant, and immaterial, and is not proper rebuttal because fully covered in direct examination.) A. It was never changed."

Having proved the original contract and the conduct of the parties pursuant to it, affirmative testimony that it was never changed was unnecessary; but one feature of the defense was that to comply with the requirements of the bank commissioner a change in the mode of business between Kelly and the bank was instituted. On that point, the evidence of Kelly was competent as rebuttal, and was introduced as such. Were it otherwise, its introduction would not be fatal. Civ. Code, sections 141, 581 (Gen. St. 1909, sections 5734, 6176).

There was no error in the court's refusal to instruct the jury to return a verdict for the defendant. We have examined the instructions given and refused, and we think those given fairly covered all phases of the controversy, but we discover nothing therein which needs discussion.

A scrutiny of the special findings does not show them to be inconsistent with the general verdict, and the first and most important of these rendered a judgment for the defendant impossible. It reads:

"Q. 1. At the time of the purchase of the Saylor's cattle by Kelly and the issuance of the check in controversy, was there a contract between defendant Kelly and defendant the State Bank of Allen to the general effect that defendant Kelly should buy live stock and draw checks upon the defendant bank in payment therefor, and that the defendant bank should pay said checks regardless of the state of the defendant Kelly's account with said defendant bank? A. Yes."

Whether the bank was to pay all Kelly's checks or only to pay so far as the return drafts for stock shipments would meet was a fair question for the jury, and the general verdict has resolved it against the defendant. Nowhere do we find anything substantial or prejudicial on which to disturb this judgment, and consequently it is affirmed. All the Justices concurring.

ON REHEARING

In a petition for a rehearing, which reargues appellant's contentions as originally presented, but which were disposed of in our opinion, and about which we are still satisfied, it is said:

"The court omits all reference to one of the most important points relied upon by appellant, to-wit, *Kelly's fraud on the bank.*"

What counsel for appellant had to say about this in their brief was not overlooked, although it was not considered necessary to comment on it in our opinion. However, in deference to criticism of counsel, we now make the observation that the record does not disclose any fraud on the part of Kelly; no fraud was pleaded as a defense to the action, and the first finding of the jury, quoted in our opinion in full, is conclusive against the appellant's contention.

The petition for a rehearing is denied. All the Justices concurring.

(163 Pacific Rep. 454.)

Building and Loan Association

NEW YORK.

*Shareholder's Rights in Building and Loan Association.*Supreme Court New York, Trial Term
Kings County, February 23, 1917.

WALLIS VS. EAGLE SAVINGS AND LOAN ASSOCIATION.

Where plaintiff subscribed for stock in a savings and loan company, signing a written agreement whereby she not only subscribed for the stock, but also applied for membership in the company, and agreed to abide by its articles of association and all regulations made thereunder, the certificates of stock issued to plaintiff, providing that the legal holder would be paid by mailed check a semi-annual cash dividend of six per cent. each year for a period of twelve years from date of the certificate, when its face value should become payable, unless previously paid, by giving sixty days' notice in writing to the secretary, and that, by giving sixty days' notice in writing to the secretary, the legal holder at any time after a year might withdraw the principal paid, together with any accrued and unpaid dividends, plaintiff was a shareholder or member of the company, and not a creditor, and her rights were to be measured and determined, on the company's being in financial difficulties and her desiring her principal back, by the relations which existed between the company and herself; as shareholder, she was amenable to the rules and regulations of the company respecting the withdrawal and payment of her shares, and was bound by the provision of the banking law as to the manner in which such claims shall be paid in cases where associations are practically in process of liquidation.

Action by Agnes C. Wallis against the Eagle Savings and Loan Company.
Judgment for defendant.

Manning, J. This is an action for money had and received, and is brought by the plaintiff against the defendant to recover the sum of \$1,300 principal and certain accrued interest, which, added to the principal, makes her total claim \$1,512.02, and for this amount she asks judgment as of February 15, 1917.

The facts, about which there is no real controversy, are as follows: On January 8, 1901, the plaintiff subscribed for ten shares of the defendant's stock, such shares being known as

"Class C" certificates, for which she paid the sum of \$100 per share, or \$1,000 in all, at the same time signing a written subscription form or agreement whereby she not only subscribed for the stock, but also applied for membership in the defendant company, and agreed to abide by its articles of association and all regulations made thereunder. On May 21, 1901, she subscribed for three more shares in class C, paying therefor \$100 per share, or \$300 in all, and at the same time agreed to abide by the articles of association of the defendant company and all regulations made thereunder. There was issued to the plaintiff at the time of her first subscription a certificate for ten shares of the par value of \$100 each, and at the time of her second subscription three certificates of the par value of \$100 each. All the certificates are identical in form and phraseology, varying only in amounts and dates, and each contains the following clause respecting payment:

"In consideration of such payment the legal holder will be paid by mailed check a semi-annual cash dividend (six per cent.) each year for the period of twelve years from the date of this certificate when its face value shall become payable unless previously paid, by giving sixty days' notice in writing to the secretary. The legal holder hereof may at any time after one year from the date of this certificate withdraw the principal paid herein together with any accrued and unpaid dividends."

The certificates contained this further clause upon the face thereof:

"This certificate is issued by authority of and subject to the provisions of the articles of association of the corporation and the regulations adopted thereunder."

The company seems to have prospered for several years after the plaintiff had become a member and made her investment, and the proof shows that she realized the following sums as dividends, viz.: Dividends at the rate of six per cent. per annum were paid semi-annually from the date of the issuance of the certificates to and including Janu-

ary 1, 1912; from July 1, 1912, to July 1, 1914, dividends at the rate of five per cent.; on January 1, 1915, no dividend was paid; and on July 1, 1916, the last dividend of two and one-half per cent. was paid. The total amount of these dividends so paid to the plaintiff amounts \$1,017.91.

On January 8, 1913, plaintiff's first investment had "matured," but she took no action thereon, nor had she filed any withdrawal. On May 21, 1913, her second investment "matured," but she took no action, nor did she file any notice of withdrawal; in fact the plaintiff did nothing looking toward the demand or collection of her money until the 17th day of November, 1914, a period of nearly two years beyond the maturity of her shares, when she filed a notice of withdrawal. The company meanwhile had begun to suffer financial reverses, and the situation became so tense that the attention of the courts and the banking department was invited. Accordingly, on the 11th day of December, 1914, an order was made and entered by the Appellate Division, distributing a loss amounting to a certain percentage among all the members of the association pursuant to section 404 of the Banking Law. After this order was made, and on or about the 31st of December, 1914, the plaintiff cancelled her notice of withdrawal, and thereafter did nothing until May 11, 1915, when she filed a new notice of withdrawal, dated May 10, 1915, and this notice, from a point of time, expired July 13, 1915.

At the time plaintiff filed her notice there were on file with the defendant company notices of withdrawals aggregating \$10,993.15, and the company had an outstanding indebtedness of \$50,000. On July 12, 1915, at the maturity of the notice, the company had in cash \$28,556.03, and there were withdrawal notices on file amounting to \$287,655.83, and the company had an outstanding indebtedness of \$75,000. On November 18, 1915, the board of directors, having regard to the extraordinary situation in which the company was placed and in compliance with the

provisions of Banking Law (Laws 1914, c. 369), section 398, passed a resolution, providing for the payment of all withdrawals ratably and in proportion, and on January 17, 1916, the superintendent of banks ordered the board of directors not to rescind such resolution. No withdrawal has been paid to any one since the latter part of May, 1915, and the amount of withdrawals now on file is \$692,497.62. The company claims to be solvent, and a fund is being accumulated out of which payments may be made upon the order of the board of directors and the superintendent of banks.

The plaintiff claims that she is entitled to the immediate payment of her money, her contention being that she is a "creditor" and not a member or shareholder of the company, and, further, that the "certificates" which she holds contain, in effect, an absolute "guaranty" of payment. The defendant contends that the plaintiff has no right to the immediate payment of the investment, and maintains that she should be compelled to await the time when others similarly situated are paid from the company's funds, in the manner provided by the statute. Plaintiff's counsel, in a very able and instructive brief, cites many cases, which, however, are distinguishable from the particular facts in the present case. The decision of the Court of Appeals in *Tautphoeus vs. H. & S. B. & S. Ass'n*, 185 N. Y. 308, is emphasized. That case, however, is also easily distinguishable from the present one. The instrument sued upon in that case, contained on the back of this indorsement:

"This certificate is guaranteed * * *
As to payment of principal sum * * *
on thirty days' written notice * * *
at any time after seventy-two months
from date hereof."

Here, as will be observed, there was an absolute and unqualified guarantee of payment which the court very properly held could not be affected by any of the by-laws. The court says at page 315:

"If, indeed, the absolute guaranty of payment printed on the back of the cer-

tificate had been omitted and the articles of association were made a part of the contract, then the purchaser would naturally examine them to ascertain when his certificate was payable."

I am convinced that the plaintiff in this case is not a creditor of the association, but her status is that of a shareholder or member, and that her rights are to be measured and determined by the relations which exist now, and have in the past existed, between the company and herself; that as such shareholder she is amenable to the rules and regulations of the association respecting the withdrawal and payment of her shares,

and, further, that she is bound by the provision of the Banking Law which provides the manner in which such claims shall be paid, in cases where associations are, as the defendant company is, practically in process of liquidation.

To hold otherwise would simply give the plaintiff a preferential place in the line of payment over others whose claims, no doubt, are just as valid as hers, and this would not be legal or equitable.

Judgment is rendered for the defendant.

(163 N. Y. Sup. 470.)



New York Chapter Announces Educational Program

IN accordance with the preparedness spirit manifested throughout the nation, New York Chapter of the American Institute of Banking is about to do its part in the promotion of efficiency among a large number of bank men and women of this vicinity. This will be accomplished through the educational courses of the Chapter which commence on October 4. Last year out of a membership of about 2,200 nearly 800 men were registered in the various courses, and there is every prospect for an equally large enrollment this year in spite of the fact that so many of the members and bank men of New York city have joined the colors.

New York Chapter, acting in conjunction with the department of extension teaching of Columbia University, will this year offer courses in banking and kindred subjects which will be divided under three different heads as follows: (1) The Standard Course following the regulations prescribed by the board of regents of the A. I. B. and covering bank organization and administration, including trust company functions, credits and loans, and the law of bankruptcy; law of contracts, law of business relations, negotiable instruments law, principles of economics, and money, banking and exchange.

(2) The preparatory course for the

younger men comprises work in elementary banking practice, commercial geography, business English, economics and the financial history of the United States.

(3) Special courses in accounting, bank advertising, bank machinery, French, Spanish, foreign trade, international exchange, mental arithmetic, public speaking and debating. The officers of instruction for these courses consist of men from Yale, Columbia, New York University and College of the City of New York, and other well-known experts on the various subjects.

In recognition of the fact that women are taking their places beside the men in so many of the banking houses of the city and are showing such sincere interest in this work, New York Chapter stands ready and anxious to offer its facilities to them. With that end in view, several of the courses mentioned above have been prepared specially with the thought of adapting them to the needs of the women employees of banks. It is expected that a large number will seize the opportunity to train themselves to such an extent that they can, with a well-founded confidence, command salaries equal to those of the men whose places they are taking.

War Taxation and Bond Issues

F. O. WATTS, president of the Third National Bank, St. Louis, addressed the Business Men's War Convention at Atlantic City, September 20, on the subject of "War Taxation and Bond Issues." This convention was held under the auspices of the U. S. Chamber of Commerce.

Mr. Watts spoke of the notable examples of unselfish devotion in the early part of the war, and said: "What has been done by those answering the call in personal service is but the promise for all, and all are ready to furnish personal service or extreme drafts on income, to the point of sacrifice. All we ask is that the financial necessities of the country be levied in the same spirit in which we stand ready to meet them."

The speaker made a stinging arraignment of bias as it has entered into a consideration of the war taxation and continued: "Happily such bias seems to be limited to the radicals in and out of Congress while the great majority are approaching the whole subject with the desire to adjust the new business, necessary to put our greatest force into the war, at the minimum of injustice to the individual and the maximum efficiency in the productiveness of the country."

In the course of his discussion, Mr. Watts pointed out many doubtful expediciencies that had been suggested eliminated, and summed up as definite conclusions the following:

(a) It is quite necessary for us to put our extreme resources for the common use of those at war with the Central Powers;

(b) Being unable to sell our credit or our property in other countries we must rely wholly on our national income;

(c) The demands are and will continue such that at least ten billion dollars

will be required of us annually, or approximately twenty-five per cent. of our annual income;

(d) Not business as usual, but unusual economies and production will be necessary in order to increase the savings from pro-war estimates of five billions to war necessities of ten billions.

(e) The Government must take the war cost from the current income of the people;

(f) The people will furnish the funds in either of two ways, or preferably both ways.

By a system of taxation or by purchasing bonds.

The speaker devoted the greater part of his address to a discussion as to whether war funds should be raised by taxation or by bonds and the question as to whether such bonds if issued, should be subject to taxation. He reviewed in discussing the former, the special report of the United States Chamber of Commerce, the policies recommended by some of the leading financiers, and learned treatises from the pens of America's foremost economists.

According to Mr. Watts, the safe course would be to raise not more than twenty-five per cent. of the excess of war requirements by taxation during the first year of the war and to raise the remainder by bond issue. This is approximately the amount proposed by the bill pending in Congress. Subsequent increases, if necessary, should be carefully made, and to some extent should reach all the people as a matter of right and for economic effects. Speaking of tax on bonds, Mr. Watts said:

"The bond issues to be made should be on a business basis. The Government should let the bonds bear such a rate as will create for them a demand by the people whose income above tax

requirements will be available. The next and the next issues of Liberty Bonds could be placed under appeals to patriotism. Americans will lose sight of Government justice on such appeals but the sums saved in the taxation of all the people and withheld from the thrifty investors in Government bonds is saved at a price too dear. Let the Government give an investor to understand that it will pay the market price and it will be found that from issue to issue the investing class will plan for and continue a steady demand for what is the best security in the world. Placed on such a business the bonds should not be exempt from the taxes to be imposed for war purposes. The injurious possibilities in the continued issuance of tax exempt bonds have become manifest. Many schedules have been made showing how such bonds would be largely increased in value by the exemption and in the end would greatly disturb the market for other securities. The difficulty of obtaining new capital is now very great. The railroads and many large industrial corporations, though doing business at record capacity, find that when funds are obtainable at all it is at a price out of keeping with the business and the credit standing of the borrower. Nothing

could increase these difficulties more than to continue to give the artificial and preferential value to the Government bonds. The change in our policy would not add materially, if any, to the ultimate cost of the funds of the Government, but that phase should be the least consideration."

Mr. Watts placed his finger on the error of the current legislation by calling attention to the fact that the class who have most benefited by the war conditions in this country, and who are, after all, the real capitalists—the farming class—have not been called upon to pay any part of the tremendous tax levy. He said that the farmers of this country are as patriotic as any other class of citizens and it is only due to a misconception and a species of cowardice on the part of the lawmakers that they are not called upon to contribute. The net incomes from the farms constitute one-third of the annual income of the nation. The Senate eliminated from the proposed bill that part of the tax on consumption, of which they might have paid a part.

The address was concluded with a well-deserved tribute to the President and others in authority upon the intelligent and masterful way in which preparations for the war have gone forward.



Facilitating Exports of American Food Stuffs to British West Africa

OWING to the prohibition of the export of food stuffs from Great Britain the Secretary of the Colonies has instructed the governors of all the British West African Colonies that all future supplies of food stuffs must be obtained from the United States, and for this purpose a service of steamers

between New York and West Africa will be maintained. In this connection it will be of interest to shippers and exporters to note that the Bank of British West Africa, Ltd., which has branches all over West Africa, has an agency in New York City at No. 6 Wall street.

New York University in Wall Street

FOR an educational institution serving Wall Street to be able to live up to all expectations of growth and success in a season said to be one of the most abnormal in the history of finance, is a noteworthy record. Such was the performance of the Wall Street Division of New York University School of Commerce and Accounts and Finance in the third year of its existence; and to those teachers and business men who conceived the idea of a "University in Wall Street," the satisfactory progress made by the school since its inception is evidence that the seeds of this unique educational enterprise have not fallen on barren ground.

Progress, it is said, is inherent in Wall Street. Mark the record of banks, trust companies and investment houses in the past five years. It has been one of steady growth. Offices have been outgrown, new buildings have been erected to satisfy the ever-increasing demand for space and still it is patent that financial institutions are expanding apace. The Wall Street Division has not failed to reflect this rapid development, for in its second year it had to seek larger quarters in order to carry on its work, and subsequently acquired additional rooms where newly organized classes might be held.

But the growth of this financial school must not be measured solely by square feet of floor space. What is the most important evidence in judging its development is the organization and expansion of its educational programme. The building up of a curriculum which will touch every phase of finance and at the same time keep abreast of current problems has been the aim of the school, and by means of close coöperation between business and education there has been developed a group of studies which realize that aim. It must not be assumed that the programme is devoted exclu-

sively to highly specialized courses. Underlying the so-called vocational studies are the courses which constitute the elements of a broad business education. The young man or woman—for the Wall Street Division is a co-educational school—ambitious to combine early business experience with special training is given the opportunity to lay the foundation for a financial career. Accounting, Economics, Business English, Commercial Law, Money and Banking, the principles of finance—these are some of the fundamental requirements for a commercial education which are given emphasis in the programme of the school, and it is an evidence of the increasing desire for thorough training that these courses are attracting large numbers of students each year. Possessed of a body of elementary knowledge, the student is in a position to make the most of the specialized courses in Banking and Brokerage, and should he be pursuing a regular university course, is equipped with the initial requirements for the degree of Bachelor of Commercial Science. Of the special courses related to Wall Street, most of these have been developed, literally on the ground, as a result of the valuable coöperation on the part of the financial concerns, and such other courses as have been introduced have been adapted to downtown conditions. The fields of investment and banking have engaged the attention of the Wall Street Division, and in planning studies in these branches of finance, their particular requirements have been carefully considered. Out of the experience of previous years gathered through contact with the financial institutions special courses have been evolved. In the investments group are now offered: Principles of Investments, Railroad Bonds, Public Utility Investments, Financial Investigations. Eco-

conomic Studies, Brokerage Methods, Bond Salesmanship, and Stock Brokerage. Each of these has a separate appeal, and the students drawn to these classes represent every side of the security business and include managers of bond departments, salesmen, and young employees who are seeking advancement. Measured by enrollment, attendance and examination results the Investments group has proven very successful during the past year, and when it is considered that office forces in the Wall Street district were overtaxed with work owing to the heavy market of last winter the success of these classes is all the more noteworthy.

In the building up of a group of subjects devoted to banking the school has received much in the way of efficient coöperation from the various banks and trust companies. Beginning with courses dealing with Money and Credit and History and Methods of Banking, the group has been gradually enlarged until now it embraces specific as well as general subjects which go far to cover every phase of the business. First principles are dealt with in Money and Banking; legal considerations are studied in Law of Banking and Commercial Paper; Methods, that is, office organization and the several systems as developed in the modern bank are taken up in Banking Practice, a course which is in charge of an experienced bank officer. The noticeable activity among New York banks in the field of foreign exchange has been reflected in the classes dealing with that branch. For beginners there is the course in the Elements of Foreign Exchange. Students have been drawn largely from the bigger institutions, but there have been sufficient numbers from private banks and from trust companies to indicate the increased usefulness of the course. Advanced Foreign Exchange, or Foreign Exchange Accounting takes the student from principles into practice. This course has been conspicuously successful and has attracted a group of foreign department men each year whose work has been characterized by scholarship and application.

Of the courses not specifically devoted to banking, those in Bookkeeping and Accounting draw many students from banks and trust companies. From Bookkeeping the beginner can advance to the principles of Accounting, and having mastered the principles he is ready to take up the advanced problems met with in Accounting Practice. This year an addition to the Accounting group, of particular interest to trust companies, will be made by the organization of a class in Fiduciary Accounting. This course, as its name implies, will be concerned with the study of accounting as related to the administration of trust estates. A trust company officer will have charge of the work.

This coming year, if judged by present conditions in business should be a fruitful one for the Wall Street Division of New York University. There is no doubt that the circumstances of war have affected and will continue to affect the financial institutions. Already a shortage of employees, in some cases acute, is apparent. The draft and voluntary enlistment have caused the withdrawal of a large number of men from positions where training and experience count. Already there have been marked changes in the office forces of several concerns; vacancies have been filled by boys and young men, and there has been a notable addition of women to the staffs affected.

This war time reorganization raises a problem for all concerned. Banks and trust companies must face it for the duration of the conflict. Fitting these beginners to take the places of experienced employes is the problem they are confronted with. In helping to meet this task successfully so that the level of business efficiency will not be lowered by reorganization, there is a distinct opportunity for education to be of service. Situated as it is in the financial center and deriving as it does the benefit of an advisory board representative of the banking and financial interests the Wall Street Division of New York University should be in a position to furnish timely and valuable coöperation.

A Significant and Eloquent Speech

VISCOUNT ISHII of Japan at the Tomb of Washington

IN the name of my gracious sovereign, the Emperor of Japan, and representing all the liberty-loving people who own his sway, I stand to-day in this sacred presence—not to eulogize the name of Washington—for that were presumption—but to offer the simple tribute of a people's reverence and love.

Washington was an American, but America, great as she is, powerful as she is, certain as she is of her splendid destiny—can lay no exclusive claim to this immortal name. Washington is now a citizen of the world; to-day he belongs to all mankind. And so men come here from the ends of the earth to honor his memory and to reiterate their faith in the principles to which his great life was devoted.

Japan claims entrance to this holy circle. She yields to none in reverence and respect—nor is there any gulf between the ancient East and the new-born West too deep and wide for the hearts and the understandings of her people to cross.

It is fitting then that men who love liberty and justice better than they love life—that men who know what honor is—should seek this shrine and here, in the presence of these sacred ashes, re-dedicate themselves to the service of humanity.

It is a fitting place, at this time, when all the world is filled with turmoil and sufferings, for comrades in a holy cause to gather and here renew their fealty to a righteous purpose, firm in the determination that the struggle must go on until the world is free from menace and aggression.

Japan is proud to place herself beside her noble allies in this high resolve and here, in the presence of these deathless ashes, she reaffirms her devotion to the

cause and the principles for which they wage battle, fully determined to do her whole part in securing for the world the blessings of liberty, justice and lasting peace.

As the representative of my people,



VISCOUNT ISHII

The Distinguished Head of the Imperial Japanese Commission, now in the United States.

then, I place this wreath upon the tomb of Washington with reverent hands; and in so doing, it is my proud privilege to again pledge my country to those principles of right and justice which have given immortality to the name of Washington.

Australia and America United in Common Cause

By WILLIAM A. HOLMAN, Prime Minister of New South Wales
[From a Speech Delivered at the Hotel Gotham, New York,
September 18, 1917]

AUSTRALIA is sunk in an almost incredible distance of ocean from the centres of European strife; 12,000 miles separate us from the intrigues, the difficulties, and the struggles of the Old World. We were isolated; we were under no compulsion of any kind, and you must accept my assurances—it is impossible to waste time in demonstrating it—we had no interests of any kind to serve, and no end to gain by entering upon such a war. It is a fact that as a result of the war the territory of Northern New Guinea has fallen into our hands. We have it. We shall keep it. We propose to keep it. We do not propose to let the Germans come back there and establish a base of operations against us, but nothing could be more ridiculous than the suggestion that that was a motive. It was an accident and not a motive.

We saw after three days of delay, which caused the most agonized heart-searchings in Australia, our own mother country coming to the support of her ancient ally, France, and from that moment every Australian heart beat with but a single sentiment, and a single emotion, that in this great trial, this battle of Armageddon, in which the forces of tyranny and the forces of right were ranged on either side, the last power of the Australian democracy should be exerted, the last resource of Australia should be exhausted, before we would permit an enslaved humanity to crouch again under the bidding of the military tyranny of the Central Powers.

There was a time when it would have

been impossible to speak in these lofty terms of the resolutions of democracy. But there was a time when it was believed that democracies were necessarily sordid; that they were guided by selfish aims, and inspired only by short-sighted and narrow views. For two or three years the action of Australia, the action of Canada, the action of Newfoundland was a puzzle to the observing and critical world. It was difficult to believe that large masses of common people were acting in this lofty spirit. Now, I venture to say that the final illustration afforded by the action of the United States is a final proof of the readiness with which democracies, great democracies, guided by great leaders, such as the leader that Providence has seen fit in His mercy to raise—for the people of the United States during this great crisis can rise above all considerations of self and make every sacrifice that may be necessary to discharge their historic task, and take the role of protectors of the future interests of mankind.

We want peace; we all want peace, but we want an enduring peace. Peace today, peace upon the terms offered by our enemies, would mean not peace, but the peaceful sloth denounced by Milton, the peaceful sloth on our part which would be the opportunity for the intensive warlike preparations on the part of the enemy. Peace today would mean the immediate preparing for the war of the future; it would mean the blighting of all progressive and democratic civilization with the military curse; it would mean the turning of Europe and of America into war camps; it would

mean the introduction of conscription not as an emergency matter to carry us over some great national crisis, but as a portion of our permanent institutions both here, in the United States, in the free nations of Europe, and in Australia itself; it would mean the concentration of all the intellectual powers of the world not upon the solution of the problems raised in the progress of civilization; not in advancing the arts of peace and of conservation, but those of war and of destruction. All science, all knowledge, all education would be prostituted to the cause of a greater and more effective warfare. Those of us who want peace want peace in order that we may be devoted to the tasks of peace; in order that we may forward the interests of humanity, and such peace can only be gained by continuing the war until we have finally destroyed, in Europe, the element which makes such permanent peace impossible. That is what we have to do, and how it is to be done is for the great statesmen of the nations to say, your President, the Councilors of England.

I would say to you that I myself, a man of peace all my life, a man who has been opposed to war on every occasion, one who has, in his own humble sphere and in his own humble capacity, urged always the claims of arbitration, of reason, of international understandings, that I am prepared to subordinate and sacrifice every other aim to the successful issue of the present war. I am prepared to let those who have flung this great calamity upon Europe realize that there is a judgment to come, that there is a penalty which awaits the evildoer.

I cannot tell you how much I feel, how much every Australian feels, the recent accession of the mighty power of the United States to the cause of the Allies. There is no sword like the sword of justice. It is that sword which is drawn in the present struggle. It has been used, and used with the utmost valor, by those who have gone thus far under enormous difficulties during the last three years, and it will be used with no less heroism by the gallant sons of

America who are now coming to turn the scale in the favor of humanity, who are now bringing their heroism and their devotion to the cause of freedom to bear upon these stricken fields, and I hope—I feel certain—that within a very little time from now, when we meet again, we may all rejoice over a common victory over a common foe, a victory which will leave us, the democracy of the world, free to work out, without fear and without trembling, the destinies of mankind.



Banks to Aid Hoover

THE following letter has been sent by the Comptroller of the Currency to certain national banks in towns and cities with a population of three thousand and over:

Hon. Herbert C. Hoover, Food Administrator, in the public interest is desirous of securing from responsible and confidential sources weekly reports as to the retail prices paid by consumers for food in towns and cities throughout the country.

He desires to find correspondents in each place who will take the trouble to inform themselves at the end of each week as to the prices which are being charged by the retail grocers and food dealers for thirty of the principal articles of food as shown on the inclosed list, and has therefore requested the Comptroller of the Currency to cooperate with him in this direction to the extent of asking the national banks throughout the country, in each town of 3,000 population or over in which there is a national bank, to recommend to the Food Administrator some person or persons who will agree to gather and to forward to the Food Administrator in Washington the figures and information desired.

It has been suggested that perhaps intelligent and patriotic women can be found in each town and city who will be willing to give their services for this purpose—possibly the wives or daughters of the officers of the banks would agree to inform themselves and forward to Washington the information sought—as a work of public service in these war times.

There will be no expense attached to this service on the part of the persons thus acting, nor is it contemplated that any compensation should be paid for the services so rendered. The necessary blank forms will be furnished by Food Administrator Hoover, who will also furnish to the correspondents thus selected the official envelopes, which can be used in mailing the statements weekly to Washington. No stamps will be required on these envelopes.

Please address your reply direct to the Hon. Herbert C. Hoover, Food Administrator, Washington, D. C. (attention: Statistical Department), suggesting to him the name of some person whom you recommend for this service and who will be willing to render such service.

Thanking you in advance for your courtesy and your prompt attention to this request, which I trust may commend itself to your patriotism in this crisis, I remain,

Respectfully,

JNO. SKELTON WILLIAMS,
Comptroller.

Bank Training in Wall Street for Women

VOLUNTARY enlistment and the selective draft have seriously depleted the labor supply in all lines of industry. Particularly affected are the banking interests where responsible positions have been held by young men who have responded so willingly to the call. Many of the banking houses have taken women in large numbers because the work required is such that women can do it, but the great difficulty is to get women who have had training or practical experience.

At the request of several banks and trust companies the Wall Street Division of New York University has arranged a short course especially adapted to the needs of women employed in banking institutions or who desire to secure positions.

The theory and practice of banking are thoroughly covered, including the operation of the most modern mechanical devices used in banking institutions and a review in the necessary arithmetic. The instruction will be given by William H. Kniffin, Jr., a practical banker, author of "The Practical Work of a Bank," "The Savings Bank" and other standard works on banking, and a teacher of experience.

The course will be intensive and so developed as to make plain the reasons for each banking operation. The class will meet twice each week for fifteen weeks. The following is a brief synopsis of the course:

1. The place of the bank in the business world.
2. The instruments of banking and their use. (Money, checks, notes and bills of exchange.)
3. National banks and the Federal Reserve System.
4. Savings banks, trust companies, and state banks.
5. Deposits and the receiving teller.
6. The paying teller and his cash.
7. Bank checks and their collection. (The transit department.)
8. The collection department.
9. Bank accounting and the uses of the various books.
10. Analysis of a bank statement.
11. Arithmetic of banking and short methods.
12. Loans and discounts, from book-keeping standpoint.
13. The work in the credit department. Collecting credit information.
14. Bank correspondence and care of bank records.
15. General review and examination.

The course should equip the student with the following:

(A) Technical instruction in the various matters that pertain to the work

PUBLISHED BY THE CORN EXCHANGE NATIONAL THE ADVANCE

PHILADELPHIA, SEPTEMBER 25, 1917

LOOK

AND

SEE

THE

REASON

WHY

WE

BUY

AND

SELL

OUR

GOODS

AND

SELL

OUR

GOODS

SEE

THE

REASON

WHY

WE

BUY

AND

SELL

OUR

GOODS

AND

SELL

OUR

GOODS

SOME few months ago we advised caution in making long term contracts. Since then we have entered the war, and business has been most active.

Many plants are still operating at capacity, but in some lines, not influenced by Government contracts, there is a hesitation that brings to not a few lips the anxious inquiry "how is business?"

The ratio of profits secured the past few years cannot continue indefinitely. It would appear that more moderate profits would be better than holding for any great length of time goods bought at high record prices.

There is no need for worry now, but if your business is not influenced by war purchases we would again suggest very careful study of conditions before contracting too far ahead for goods.

Charles F. Wall
President

Wise Precaution Suggested

of a bank, with the end in view of making her an intelligent worker, knowing the correlation of the various activities of a bank.

(B) Instruction and thorough drill in the use of adding, transit and bookkeeping machines.

(C) Practice in arithmetical calculations used in bank work. Full information can be secured from A. W. Taylor, director of Wall Street Division of New York University, 25 Broad street.



No Premature Peace

By HON. CHARLES N. FOWLER,
Ex-Congressman from New Jersey

IN point of principles involved this is the most momentous war that has ever been waged in the history of the human race. It is as much bigger in point of principle as it is greater in point of money expended, now approaching the hundred billion mark. It is as much bigger in point of principle as it is in point of men engaged, now

approaching the thirty million mark. It is as much bigger in point of principle as it is in point of peoples who have taken sides, now approaching nine-tenths of all mankind. And shall we throw away this opportunity of placing the entire world upon the firm and everlasting foundation of self-government—government founded upon right, justice and humanity?

Let there be no premature peace. The answer of the Allies must be, No peace until the world is made safe for democracy and representative government.

This greatest of all wars may end within three months. It may last three years. The probabilities are that it will not go into July of next year, but if it lasts thirty years there must be no ignoble peace, no compromise of the great principles at stake. A glorious victory on the one hand and an unmistakable defeat on the other are essential to a conclusive and final decision of the issues involved, if the principle of self-government, government resting upon right, justice and humanity, is to be established throughout the world.

Book Reviews

INTEREST TABLES. By Montgomery Rollins. Montgomery Rollins, Boston, Mass. Price, \$0.50.

This is a vest-pocket edition showing interest on one thousand dollars for one day to six months, inclusive, on the basis of 360 days to the year. Also for one day to 184 days, inclusive, on the basis of 365 days to the year. Contains special tables for $4\frac{1}{4}$ and $5\frac{1}{2}$ per cent. rates.



STORY OF THE TRUST COMPANIES. By Edward T. Perine. G. P. Putnam's Sons. Price, \$2.00.

The present book is intended, with an avoidance of technicalities, to sketch

the beginnings and advances of the older trust companies, and to bring the individual narratives of a number of the largest institutions down to 1916.

The book covers a wide range of financial and historical data, depicts the quaintness of trust company undertakings of old, and as to our own times is a recital of great deeds constantly undone. It is an account of high ideals, profound discernment, and merited success, all presented with the charm of an entertaining story.



HOW TO ADVERTISE. By George French. Doubleday Page Co. Price \$2.00.

In this book Mr. French probes the causes of the amazing waste in adver-

tising and shows how to build advertisements that "get results."

He avoids the pit-falls of generalities, and drives home his points with concrete examples of advertisements that have made or missed their mark.

The thorough treatment of every aspect of the subject recommends this book as a work of reference and of fresh ideas for everyone whose business bears in any way upon advertising.



THE VALUE OF MONEY. By B. M. Anderson, Jr. Macmillan Co. Price, \$2.25.

Since the value of money can not be studied successfully as an isolated problem, it has been necessary to consider virtually the whole range of economic theory; the whole theory of value; the role of money in economic theory and the functions of money in economic life; the theory of values of stocks and bonds, of "good will," established trade connections, trade marks, and other "intangibles;" the theory of credit; the causes governing the volume of trade, and particularly the place of speculation in the volume of trade; the relation of "static" economic theory to "dynamic" economic theory.



READINGS IN MONEY AND BANKING. By Chester A. Phillips. The Macmillan Co. Price, \$2.10.

This volume contains selections from the best available literature dealing with money and banking and is carefully indexed so as to enable the student to turn readily to the phase of the subject in which he is most interested.

In fifteen selections, covering about fifty pages, the subject of foreign exchange is treated clearly and comprehensively. A group of chapters on foreign banking systems is designed to place the reader in a position to criticize constructively our own banking system. A thorough analysis of the

weaknesses of that system before the reform of 1913 constitutes a background for a detailed study of the Federal Reserve System.



BANKING FORMS. New York. The Banking Law Journal. Price, \$1.00.

For its eleventh year-book the "Banking Law Journal" of New York has published a practical and up-to-date set of banking forms, arranged in groups covering the various departments in a commercial banking institution, and also including forms for trust companies and savings banks.

In addition to illustrations and descriptions of the standard forms used in the classes of institutions named, due attention is given to the many new banking forms and devices for facilitating the routine work of banks which have been demanded by the marvelous growth of the banking business in recent years.

Forms of the character embodied in this book are most useful, since they give a large amount of practical banking information in compact shape. In the present instance they have the advantage of being printed in a most attractive and convenient style.



EXERCISES AND QUESTIONS FOR USE WITH "PRINCIPLES OF MONEY AND BANKING." By Harold G. Moulton. University of Chicago Press. Price, \$0.54.
PRINCIPLES OF MONEY AND BANKING. Price, \$3.00.

It is coming to be more and more recognized that if study is to be of lasting value it must be supplemented by an abundance of interpretative questions and concrete problems.

"Principles of Money and Banking" to which this volume of exercises applies, discusses the pecuniary organization of society and the development of our currency system. Bimetallism, paper money, and the silver movement are some of the questions presented.

The second portion of the book is

International Banking and Finance

SPECIAL

The **BANKERS
MAGAZINE**

SECTION

THE closer commercial and financial relations between the leading nations of the world tend continually to increase the interest which the bankers of one country have in the affairs of other countries. With the extension of American banking into foreign fields, and the growth of New York and other cities of the United States as banking centres, the bankers of this country desire to keep well informed as to the progress of trade, banking and finance the world over.

It is to meet these requirements that the department of International Banking and Finance has been established and will be maintained as a leading feature of The Bankers Magazine.

The Russian Market; Its Possibilities and Problems

By A. J. SACK, Director, Russian Information Bureau, New York

THE present war and the Revolution undoubtedly opened a new era in Russian industrial development, and there is no question but that by a proper and active policy the United States will share largely in this development in Russia.

Russia needs the help of American capital and business enterprise in her economic development. The United States, with a surplus capital and with a steadily increasing industrial production, requires the immensely large Russian market as an outlet for its trade and its investment. The two countries are in a position to supplement their respective economic requirements.

The present war has created many changes in the prospects for the development of a close economic coöperation between Russia and the United States. but even prior to the War there is strong evidence showing the tendency towards economic coöperation between Russia and the United States. The changes effected by the present war are therefore only an emphasized continuation of the natural tendency towards an American-Russian economic rapprochement.

The United States' export to Russia always has been greater than Russia's export to the United States. By comparing the Russian and the United States' statistics referring to the United States' export, the following table is obtained:

UNITED STATES EXPORT TO RUSSIA

(Yearly average in millions of dollars.)

	—According to—	
	United States Statistics.	Russian Statistics.
1878-1890	11.9	15.5
1891-1900	7.5	22.0
1901-1910	16.7	28.3
1911-1913	25.4	42.3

In this table preference must be given to the Russian statistics. A great part of the goods en route from the United States to Russia was frequently re-loaded in West-European ports and therefore appeared in the United States' statistics as export to Germany, Great Britain or Holland. "The United States is playing a greater part in our trade," says the official report of the Russian Ministry of Finance, "than can be seen in our statistical reports. The real amount of our trade with the United States is not obvious, on the one hand, because of our undeveloped direct trade relations, and on the other hand because of the middleman's part, played until now by Germany and Great Britain."

This official Russian statement can be reversed to interpret the American side of the situation. Russia is playing in the United States trade a considerably larger part than can be seen in United States statistics. The two countries have need of one another and, therefore, trade between them developed even under the most adverse circumstances. It is impossible to say what was the real amount of American-Russian trade, but assuredly considerable quantities of Russian goods were successfully brought into this country and great quantities of American goods were successfully brought into Russia.

GOODS NEEDED IN THE UNITED STATES IMPORTED FROM RUSSIA

Russia supplies the United States almost exclusively with raw materials. In 1910 Russia's entire export to the United States, according to Russian statistics, amounted to 4.84 million dollars. Of this, 4.69 million dollars—about ninety-seven per cent.—was raw mate-

Commercial New York covered daily

To eliminate the possibility of the loss of two days' time in the collection of items, the "Irving" covers Manhattan Island personally.

Every morning before ten o'clock thirty-five messengers leave the note teller's department and by early afternoon, they have personally presented every one of that day's collection items on Manhattan Island, downtown Jersey City and Commercial Brooklyn.



IRVING NATIONAL BANK

WOOLWORTH BUILDING NEW YORK

Strictly a Commercial Bank.

Resources over \$100,000,000

rials. Such products as hides and skins, wool, horse manes, horse tails and bristles hold first place among these exports. Russian statistics accredit these goods with a yearly average of 2.22 million dollars for the period 1906-10 out of 3.82 million dollars of Russia's entire export to the United States.

Second place should be given to licorice root. It is of interest to observe that the United States is almost the sole market for Russia's licorice root. In 1910, out of 29.24 million pounds of Russia's total export of licorice root, 27.73 million pounds were exported to the United States.

Besides the products mentioned above, it is necessary to call attention to Russia's export of rubber waste, manganese ore, flax and hemp. According to United States reports, the export of these goods to the United States was greater than the Russian statistics show. During the period 1906-10 the United States' import of rubber waste averaged 4.83 million pounds, accord-

ing to Russian statistics, and 6.53 million pounds according to the United States' reports. As for manganese ore, Russia reported 24.33 million pounds and the United States reported 30.4 million pounds. The most noteworthy difference is found in the statistical reports relating to Russia's export of flax and hemp. According to the Russian statistics, the yearly average of Russia's flax exported to the United States during the period 1906-10 amounted to 481,100 pounds. According to the United States' statistics, it amounted to 6,786,000 pounds. The corresponding figures for hemp are 241,800 pounds in Russian statistics.

According to the statistics of both countries, therefore, during the ten years previous to the present war there has been a remarkable increase in the exportation to the United States of Russian raw materials consisting chiefly of licorice root, hides and skins, furs, hair and bristles, wool, hemp, horses' manes, horses' tails, pulp and rubber

waste. The American statistics show also that a considerable amount of flax and flax tow must be added to this list.

During the war, on account of the restrictions placed by the Russian Government on the movement of Russian raw materials to the United States, it has been difficult to secure a free importation from Russia to this country. There has been, however, a very steady increase in the demand for Russian raw materials of all kinds. This is particularly true of furs and fur skins, of hides and skins, especially calf skins and goat skins, and also of Russian seeds. A typical illustration is the fact that prior to the war the United States purchased most of its sugar beet seed for planting purposes in Germany. Germany in turn secured the bulk of this seed from Russia. Since the war direct relationships have been opened and the United States has imported large quantities of Russian sugar beet seed. Careful estimates show that there is a market demand in the United States for from 60 to 75 million dollars' worth of Russian raw material, which forms a nucleus for a large reciprocal trade with America, and to some degree discounts the idea that the trade between the United States and Russia is not supplemental in nature.

**GOODS NEEDED IN RUSSIA IMPORTED FROM
THE UNITED STATES**

As to the United States export to Russia, there is again a great difference

in the Russian and the United States statistics relating not only to trade totals, but to individual articles of trade.

Cotton holds first place in the United States export to Russia. It has been noted before that the amount of cotton exported to Russia by the United States in 1910, according to statistics on this side, was 30.89 million pounds, whereas Russia reports 164.95 million pounds. And undoubtedly, even Russian statistics do not cover the entire amount of cotton coming originally from the United States.

Machinery and technical supplies hold second place in the United States export to Russia. And here special mention must be given to agricultural machinery and implements. During 1901-5, according to Russian statistics, the entire United States export of machinery to Russia amounted to 3.23 million dollars, yearly average; of this 2.73 million dollars covered the United States export of agricultural machinery and implements. Reports for the period 1906-10 give 4.94 million dollars as the entire machinery export, of which 4.43 million dollars covers the export of United States agricultural machinery and implements to Russia.

It is interesting to note that in the United States statistics relating to the export of agricultural machinery and implements to Russia, larger figures are given than those above. Reports on this side give 3 million dollars as the annual average for the period 1901-5, as against the 2.73 million dollars quoted by the Russian reports. Corresponding figures for the period 1906-10 are 5.17 million dollars, according to American statistics, and 4.43 million dollars, according to Russian reports. For 1913 there is 5.31 million dollars according to the United States' statistics and 4.7 million dollars, according to Russian reports. It is natural to expect the Russian figures to be higher than the American, because the Russian estimate is a combined estimate of the price in the American port plus freight, insurance, loading expense, and even often including the profit of the West-European middleman. The report of

Liberty Trust Company

8, Place Edouard VII.

Total Resources Over

\$10,000,000

PARIS · FRANCE

The First National Bank of Chicago

welcomes and appreciates the accounts of banks and bankers. Its extensive clientele, developed during more than fifty years of consistent, considerate service, is splendid endorsement of the agreeable and satisfactory relations maintained with correspondents.

Capital and Surplus, \$20,000,000

JAMES B. FORGAN
Chairman of the Board

F. O. WETMORE
President

the Russian Ministry of Finance explains the situation very clearly. "Part of the American machinery," says the report, "after being reloaded in Germany, England or Denmark, is registered in our statistics as coming from these countries and not from the United States."

The same may be said about copper, which holds third place among the goods imported in Russia from the United States. According to Russian statistics, the United States copper imported averaged yearly 8.88 million pounds during 1901-10. On the other hand, according to the United States statistics, the amount was 18.52 million pounds. It is seen that the amount of United States copper that entered Russia, according to American statistics, was more than double the amount given in Russian reports. The Russian Ministry of Finance gives again a very definite explanation of the situation: "We receive United States copper,"

says the report, "through Germany's and Great Britain's hands."

A remarkable discrepancy occurs further in the statistics relating to United States flour imported in Russia. According to Russian Statistics, the yearly average import of United States flour of every kind, excluding potato flour, during the period 1906-10 amounted to 15.7 million pounds. On the other hand, according to the United States statistics, the yearly average export to Russia of only wheat flour, for the same period amounted to 75.81 million pounds. The flour is exported mostly to Finland and because of the lack of direct connections with the United States, it is registered in Finland as brought from Germany. This fact has been mentioned more than once even in the German official reports.

The accompanying table shows growth of the United States export to Russia before the war, according to the United States statistics.

The figures just quoted, together

COX & CO. (France) Ltd.

place their branches in France at the disposal of the Military and Naval forces of the United States, in Europe, for the remittance of funds and general banking business.

This bank was formed as a subsidiary of Cox & Co., founded in 1758, 16 Charing Cross, London, the official British Army Agents, for the convenience of the British Army in France.

Branches have been established with a British Staff at all the chief military bases.

Paris, Rouen, Havre, Boulogne, Amiens, Marseilles,

and agencies at

COX & CO., 16 Charing Cross, London,

and

LONDON & SOUTH-WESTERN BANK, LTD.,

170 Fenchurch Street, London.

who are the joint proprietors.

UNITED STATES YEARLY AVERAGE EXPORT TO RUSSIA (In Thousands of Dollars)

	1891-1895	1896-1900	1901-1905	1906-1910	1911-1913
Cotton (raw)	4,811.0	3,006.0	5,909.0	5,478.0	5,685.5
Agricultural machinery and implements	323.4	684.4	3,000.0	5,178.0	7,729.7
Copper (unmanufactured)		822.0	1,632.0	1,112.0	1,322.7
Wheat flour	136.0	395.0	773.0	1,895.0	3,360.0*
Leather (prepared)....		1.3	1.8	162.0	1,075.3**
Machine oil and paraffin	1.0	9.1	71.1	151.2	232.8**
Rosin	241.0	285.0	275.0	320.0	737.0
Typewriters		126.1	172.7	367.8	846.9
Cash registers	26.0	124.0	249.4**
Sewing machines.....		28.1	36.3	232.9	768.3**
Scales of every kind..	29.4	70.5	54.0	57.0	58.6**
Twine, cord, etc.	11.7	28.5	299.9	753.0	1,646.4

*This is the figure for 1911. No figures are given for 1912 or 1913.

**Figures for 1913.

with the figures quoted previously regarding Russia's export to the United States, show quite clearly along what lines the American-Russian trade rapprochement had begun to develop even before the war, before the remarkable changes produced in the economic situation of both countries. Russia sup-

plies and will supply this country with raw materials of the highest quality. The amount of Russian raw materials brought to this country is much greater than can be seen from Russian or even United States statistics. By creating direct connections with Russia, by careful study of the conditions of the Russian market, by an active trade policy, the amount of raw materials brought to the United States from Russia can be multiplied many times to the benefit of both countries.

On the other hand, the United States supplied and will supply Russia with all kinds of machinery, with all kinds of products that presuppose a highly developed industrial culture. The possibilities of such trade, very apparent before the war, are emphasized by the events of the war. Germany, which in 1913 held 52.6 per cent. of all Russia's import, is now withdrawn from the field. By proper and active policy, the United States can now not only develop

NOYES & COMPANY

Established 1879

Foreign Bills

Government and Municipal Bonds

8, Place Edouard VII.

PARIS - FRANCE

that line of her trade with Russia that showed a natural tendency to develop before the war, but even introduce into the Russian market a full line of goods never before brought into Russia from the United States.



Trading With Latin-America

AMONG recent books on the subject of foreign trade there is one issued by the Irving National Bank of New York, entitled "Trading with Latin-America," which constitutes an interesting departure from the customary treatment of that subject. It treats our always interesting trade relations with Latin-America in a live, business-like way which should appeal strongly to the business man. In outline it is broad and comprehensive, giving a detailed description of commercial conditions now prevailing in the several republics of Central and South America, and suggestions regarding the utilization of these conditions to the mutual advantage of all exporters interested in entering this field and of the Latin-American peoples themselves as well.

There is a series of helpful suggestions on methods of approach—a particularly interesting subject in view of the general tendency of the average North American business man to overlook the differences between the personal characteristics, environment, language, education, and general point of view of the Latin-American and those of the ordinary every-day business man. The book states:

"Sales plans and methods must be adapted to conditions. These differ in various countries and localities. Unless the manufacturer is willing to conform, it is best not to make an attempt to win the trade. A most dangerous policy is to take a 'flyer' in foreign business."

The handbook shows what the methods of meeting and doing business with these people should be, and in a variety of ways makes easier the commercial contact which our commercial representatives find so difficult. The South



Advice to Investors

Purchase your securities through responsible dealers who have proper facilities for investigations and a reputation to maintain for reliable advice.

K. N. & K. are always posted on general market conditions, and their views are at the disposal of investors through their monthly review of

"The Investment Situation"
Write for pamphlet *L-I*

Knauth · Nachod & Kuhne

Members of New York Stock Exchange.

**Equitable Building,
NEW YORK CITY.**

Americans are anxious and ready to carry on commercial transactions with us at any and all times.

Financial conditions are discussed in their relation to the carrying on of successful trade negotiations, and various well-defined ways and means of financing these commercial transactions are submitted for the reader's consideration.

The chapters on Export Commission Houses and Export Merchants, Export Department Organization, Export and Foreign Trade Journals, and Suggestions for an Export Library, will be found of particular interest to the exporter for whom this work has been compiled.

Statistics regarding Latin-America, its climate, population, currency situation, buildings, and market-places—the latter an interesting phase of the life of these people in revealing their local manner of buying and selling their wares—are given in detail.

THE BANK OF CHOSEN

Incorporated by Special Charter of Imperial Japanese Government

(¥0.50 — 1 Yen)

Subscribed Capital, Yen 20,000,000

Paid-Up Capital, Yen 12,500,000

Head Office, Seoul, Korea

Principal Branches:

KOREA: Chemulpo, Pyongyang, Wonsan, Fusan

MANCHURIA: Mukden, Dairen, Changchun, Newchwang, Harbin, Antung

JAPAN: Tokyo, Osaka, Kobe

Affiliated Bank:

VLADIVOSTOK: Matsuda Bank

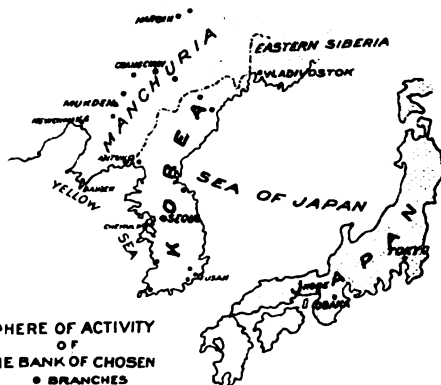

SPHERE OF ACTIVITY OF THE BANK OF CHOSEN
• BRANCHES

Principal American Correspondents:

Guaranty Trust Company of New York
Irving National Bank, New York
National City Bank of New York
National Bank of Commerce in New York

Yokohama Specie Bank, New York and San Francisco
Canadian Bank of Commerce, San Francisco and Seattle

The necessity for preparing catalogues to show the Latin-American purchaser the kind of merchandise to be submitted for his inspection, is emphasized in this book which shows in detail the kind of results that can be obtained by compiling a high grade catalogue and accompanying it with a personally written letter in which the merits of the particular article to be sold are brought to the prospective customers' attention.

The book on the whole presents to the exporter a complete and concise handbook of valuable and well-arranged information upon the entire Latin-American situation, and a copy of it will be forwarded by the Irving National Bank to those interested upon written request.



English Joint Bank in France

LLOYDS Bank (France), formed in 1911 as a separate company to represent Lloyds Bank in Paris, it has

been announced, will change its name to Lloyds Bank (France), and National Provincial Bank (France), Limited, under the joint proprietorship of Lloyds Bank and the National Provincial Bank. The head office of the bank will be in London and the capital will be increased from £600,000 to £1,200,000.



Bank of British West Africa, Limited

THIS bank, whose head office is in London, reported net profits for the year ending March 31, 1917, of £64,759. Of this sum £14,000, being three and one-half per cent. for the six months to end of September, has already been distributed in interim dividend, and the directors recommended the payment of a final dividend at the rate of four and one-half per cent. for the second half year, absorbing a further sum of £18,000, making the distri-

**Save
and
Serve!**



**Buy
Liberty
Bonds!**

Space donated by Redmond & Co., New York

tribution for the year eight per cent. less income tax. The directors have further applied £10,000 to writing down premises and furniture account, £5,000 to the staff fund, £5,000 to the bank's insurance fund, and they have added £10,000 to reserve. The balance of £18,176 16s 5d is carried forward.

Branches at Manchester and at Nsawam (Gold Coast), and the bank's own agency at New York, were opened during the financial year, and since the close of that period, branches at Jos (Nigeria, at Fernando, Po, and at Mazagan (Morocco) have been established.

Owing to his acceptance of high state office, Viscount Milner, G.C.B., G.C.M.G., retired from the board in December, 1916.

The vacancy thus caused has been filled by the election of the Earl of Selborne, K.G., G.C.M.G., as a director and chairman of the board. Under the articles of association, Lord Selborne retires, but offers himself for re-election.

The Bank of British West Africa, Ltd., has a subscribed capital of £1,400,000 and a reserve of £220,000.



Yokohama Specie Bank Opens Seattle Branch

THE Yokohama Specie Bank, Ltd., whose head office is at Yokohama, Japan, has opened a Seattle office in handsome quarters in the Central Building, at the corner of Third avenue and Marion street. H. I. Kudo, who formerly lived in Seattle and was a student at the University of Washington, is agent in charge of the local branch, and T. Innoyue, assistant agent. The Seattle branch will not conduct a commercial banking department, but will confine its operations to the handling of foreign exchange, letters of credit, drafts and the facilitating of export business to the various

BANKAKTIEBOLAGET SÖDRA SVERIGE

Head Office: HELSINGBORG, Sweden

Branches: STOCKHOLM, GOTHENBURG, MALMÖ, BORÅS and in 48 other
Places in Sweden

(\$0.26 = 1 Kr.)

Capital Paid Up	. . .	Kr. 30,000,000
Surplus About	. . .	Kr. 15,000,000
Resources About	. . .	Kr. 260,000,000

The organization and excellent relations of this Bank secure to its clients the most efficient handling of their business on moderate terms

Inquiries and applications for terms are cordially invited and will find prompt attention

Principal New York Correspondents { The Mechanics & Metals National Bank
The National City Bank of New York

countries in which the bank is represented.

To celebrate the opening of the branch and the entrance of the bank into the Seattle field, Mr. Kudo was



R. ICHINOMIYA

Manager New York Branch, Yokohama Specie Bank, Ltd.

host at an elaborate banquet at the Hotel Washington on the evening the branch was opened. The guest list included officials of Seattle banks, visiting officials of the Yokohama Specie

Bank, Japanese consular officers and Seattle men prominent in the export business. Several notable addresses were made, in which the speakers referred to the long continued friendship between the two great nations of the Pacific, and emphasized the service this great banking institution would give in the expansion of Seattle's foreign trade.

In this connection it may be mentioned that the Yokohama Specie Bank has maintained a branch in New York since 1887. For the past ten years this branch has been under the able management of Mr. R. Ichinomiya.



John MacGregor Grant

THE representative in New York of the Banque Russo-Asiatique, Mr. John MacGregor Grant, is a man of wide experience in financial affairs and of important banking and commercial connections. Besides being the New York representative of Russia's largest bank, he is president of John MacGregor Grant, Inc.; United States manager Second Russian Insurance Co. and president of the American Traffic Co.

At the age of eighteen Mr. Grant entered the employ of the Caledonian Bank of Scotland, and from 1896 to 1902 was assistant manager of the foreign exchange department of the Merchants Loan and Trust Co., Chicago. In 1902 he became associated with the American Express Company's Chicago

The Union Bank of Manchester, Limited

Head Office
17 York St., Manchester, Eng.

Liverpool Office
45 Castle St., Liverpool, Eng.

and branches covering the whole of the district tributary to these two cities, and also WEST YORKSHIRE; including SHEFFIELD, BRADFORD, SALFORD, BIRKEN-HEAD, OLDHAM, BOLTON, BURY, ROCHDALE, STOCKPORT, HALIFAX (ENG.), HUDDERSFIELD, etc., etc.

(\$5=£)

Nominal Capital	\$12,500,000
Paid-up Capital -	2,750,000
Reserve Capital	3,500,000
Subscribed Capital	6,250,000
Reserves	1,903,470
Surplus over Liabilities	<u>8,153,470</u>

Bankers in the United States and Canada are invited to make use of the Bank's services for all kinds of banking business in the district where the Bank operates, and in Great Britain generally. Collections promptly dealt with, and proceeds remitted by draft or cable transfer on New York, or as desired. Favourable terms.

office and was made manager of the financial department in Europe, with headquarters in London. In 1907 he was appointed assistant treasurer of the American Express Company in New York and placed in charge of the company's financial business.

In these several capacities Mr. Grant has gained most valued financial experience which specially qualifies him as representative here of one of the great European banks.

BANQUE RUSSO-ASIATIQUE

This institution's New York Agency is at 120 Broadway. The New York office of the bank has been opened in view of the coming economical, financial and industrial development of Russia and in recognition of the importance of a connection between the two great Republics that will assist towards a better understanding of each other. At present the New York office is not prepared to accept funds either for de-

posit or for remittance to Russia. Its aim is primarily to form a link between the two countries that will tend to establish closer, more friendly and more sympathetic economic relations.

It is recognized that in the development of her great natural resources, Russia will require the assistance of American capital, American equipment and experience born of America's own great struggle for national existence fifty years ago. A new Russia is slowly but surely emerging—a Russia that will welcome friendly trade relationship with a country having no political designs or ambitions to dominate—and notwithstanding the various alarming, pessimistic and, in some instances, malicious reports, regarding the present conditions in Russia, those who know Russia and who recognize the innate good sense of the Russian people, know also not only that the future of the new Russia is assured, but also that her industrial and financial position stands firm on the rock of her wonderful un-

developed natural resources, backed by one hundred and eighty millions of honest, industrious, generous-hearted people.

The New York office of the bank expects to be of material assistance in the

in Russia are for any reason unsatisfactory.

The Banque Russo-Asiatique is, of all the Russians banks, the largest, the most progressive, and the closest in touch with Russia's financial and industrial interests. It has one hundred and thirty-three branches in Russia; its capital is roubles 55,000,000; its surplus roubles 35,000,000, and its deposits roubles 1,200,000,000, which latter, at the normal rate of exchange, is equivalent to \$600,000,000 in American money.

The relative importance of the Banque Russo-Asiatique may be seen from the accompanying statement:



Bankaktiebolaget Sodra Sverige

THIS bank, whose head office is in Helsingborg, Sweden, has total resources of Kr. 216,377,680, a capital of Kr. 25,000,000 and a reserve of Kr. 12,600,000. Net profits for the year 1916 were Kr. 2,757,800.

Since 1902 the capital of this bank has increased from Kr. 10,000,000 to Kr. 25,000,000. The dividend rate over the same period has increased from eight per cent. to ten per cent.



An American Bank for Foreign Trade in Northern Brazil

THE Mercantile Bank of the Americas, Inc., New York, will shortly open an American Bank at Para, Brazil. This bank has been extending its business gradually by the establishment of American institutions in Peru, Ecuador,



JOHN MACGREGOR GRANT
New York Representative Banque Russo-Asiatique

new development and freely offers its services and coöperation to those interested either in furthering trade with Russia or in developing her resources. Mr. Grant is particularly anxious to be of assistance to banks in this country that maintain accounts with the Banque Russo-Asiatique and branches, as well as to banks whose present connections

	Capital	ROUBLES Surplus	Deposits
Banque Russo-Asiatique	55,000,000	35,000,000	1,200,000,000
Russian Bank for Foreign Trade.....	60,000,000	21,000,000	950,000,000
Petrograd International Bank	60,000,000	35,000,000	860,000,000
Volga Kama Bank	21,000,000	23,000,000	811,000,000
Azoff Don Bank	60,000,000	50,000,000	790,000,000
Russian Commercial & Industrial Bank.....	35,000,000	10,000,000	700,000,000
Siberian Bank	30,000,000	18,000,000	600,000,000
Petrograd Discount Bank	30,000,000	15,500,000	300,000,000

Leu & Co.'s Bank, Limited

Zurich, Switzerland

FOUNDED 1755



Capital Fully Paid Up } Frs. 46,000,000
and Reserve Fund }

Every description of Banking and Foreign Exchange business transacted.

Drafts and Letters of Credit issued payable in all parts of the world.

Telegraphic Transfers Effected.

Booking and Travel Department.

This bank is thoroughly equipped for handling business between the United States, Switzerland and other European countries.

LONDON AGENTS: London and Southwestern Bank, Ltd.; Credito Italiano; Swiss Bankverein.

Agents and Correspondents in all parts of the World

MANAGERS

CHAS. J. BRUPBACHER

H. DIETLER

R. G. BINDSCHIEDLER

Venezuela, Colombia, Nicaragua, and other Central American Republics, as well as in Paris, Barcelona and Genoa.

The Amazon River district is probably one of the territories that has not as yet been extensively exploited by Americans. The entry of this American Bank for foreign trade in the district mentioned should be interesting to bankers, manufacturers and importers, as it will, no doubt, tend to develop American trade and extend our relations over a new and vast commercial field.



Report National Bank South Africa, Limited

WITH a subscribed capital of £2,850,000 and a reserve fund of £700,000 the National Bank of South Africa, Limited, with head offices in Pretoria, South Africa, and New York offices at 10 Wall, on March 22, 1917,

showed total resources of £38,618,353. Deposits amount to £27,246,501 and the profit and loss account balances at £1,034,924 with gross profits after deducting interest taxes, etc., £1,034,924. With this bank are incorporated the Bank of Africa, Limited, established 1879, the National Bank of the Orange River Colony, Limited, established 1877, and the Natal Bank, Limited, established 1854.



The Mitsui Bank, Limited, Tokyo

THE June 30, 1917, balance sheet of this bank shows net profits for the half year of yen 2,151,225, which was appropriated as follows: To reserve fund, yen 1,350,000; to pension and provident funds, yen 56,100; to bonus, yen 215,100; to dividends to shareholders, yen 500,000.

This bank has a paid-up capital of

MERCANTILE BANKING COMPANY, Ltd.

Avenida Francisco I. Madero No. 12

CITY OF MEXICO, D. F.

Capital and Surplus, \$600,000.00

GEO. J. McCARTY, President K. M. VAN ZANDT, Jr., Vice-President and Manager H. C. HEAD, Cashier FCO. COUDURIER, Asst. Cashier

Members: American Bankers' Association, Texas Bankers' Association, Mexico City Clearing House

GENERAL BANKING TRANSACTED TELEGRAPHIC TRANSFERS

Foreign Exchange Unsurpassed Collection Facilities Throughout the Republic

SEND US YOUR MEXICO BUSINESS

WRITE US UPON ANY SUBJECT WHICH MAY BE OF INTEREST TO YOU IN THE REPUBLIC OF MEXICO. P. O. Address: Apartado 1846.

yen 20,000,000 and a reserve fund of yen 10,850,000.



Imports and Exports of British South Africa

THE May 30, 1917, trade report of the National Bank of South Africa, Limited, gives a table showing the imports and exports for British South Africa during the three months ended March 31. This compares favorably with the same period in 1916.

Manager Royal Bank of Canada in New York

F. F. WALKER, formerly Montreal manager of the Royal Bank of Canada, has been appointed manager of the branch of the Royal Bank of Canada in New York. R. L. Ritchie, branch manager for the bank at Regina, Winnipeg, and Halifax, succeeds Mr. Walker at Montreal.

	THREE MONTHS ENDED MARCH 31 1917.	1916.
	£	£
IMPORTS		
Apparel and Slops	656,390	655,343
Cotton Manufactures	1,279,119	951,714
Articles of Food and Drink	1,298,593	1,479,209
Furniture	81,532	105,294
Haberdashery and Millinery	233,050	262,082
Hardware and Cutlery (Fencing Materials, Tools, etc.)	327,401	266,366
Agricultural Implements	98,311	70,207
Iron and Steel, Manufactured—except Machinery	326,516	260,855
Leather Goods (Boots and Shoes, etc.)	304,442	368,569
Machinery	519,267	466,258
Railway Material	20,196	26,547
Printed Books	59,313	56,718
Motor Cars	195,644	184,952
Wax—Paraffin and Stearine	136,773	48,967
Wood and Timber	222,147	236,663
Woollen Manufactures	228,084	190,410
All other Merchandise, not specified above	2,933,492	2,772,979
Total Merchandise Imported	8,920,270	8,402,943
Imports for South African Government	341,536	446,694
Specie	477,287	224,275
Grand Total Imports	9,739,093	9,073,912
EXPORTS		
Animals, Living	13,729	13,334
Coal	70,632	63,044
Diamonds	1,792,319	881,051
Ostrich Feathers	55,948	147,544
Articles of Food and Drink	628,625	572,392
Hair, Angora	88,424	191,426
Hides and Skins	598,603	399,834
Copper	512,162	449,451
Other Ores and Minerals	161,142	93,647
Wool	2,095,810	1,868,240
All other Merchandise, not specified above	368,412	300,792
Total South African Produce	6,383,804	5,010,755
Imported Goods Re-exported	750,781	455,799
Specie	16,147	8,515
Grand Total Exports	7,150,732	5,475,069

Banking and Financial Industry

SPECIAL

**The BANKERS
MAGAZINE**

SECTION



THE LIBERTY NATIONAL BANK *of* NEW YORK

CAPITAL \$3,000,000.00

SURPLUS 3,000,000.00

UNDIVIDED PROFITS 1,010,300.00

OFFICERS

HARVEY D. GIBSON President
DANIEL G. REID Vice President
CHAS. W. RIECKS Vice President and Cashier
ALEXANDER M. HALL, 2nd Vice President
ERNEST STAUFFEN, Jr. Vice President
JOSEPH A. BOWER Vice President
FREDERICK P. McGLYNN Assistant Cashier
THEODORE C. HOVEY Assistant Cashier
LOUIS W. KNOWLES Assistant Cashier
FREDERICK W. WALZ Assistant Cashier
SIDNEY W. NOYES Assistant Cashier



National Bank of South Africa, Limited, Head Office, Pretoria

The National Bank of South Africa, Limited

THE National Bank of South Africa, Limited, acts as bankers to the Government of the Union of South Africa, in the provinces of the Transvaal, the Orange Free State and Natal, three out of the four provinces of the Union. Its head office is in Pretoria which is the administrative capital of The Union of South Africa. The London offices are at Circus Place, London Wall, and at 18 Saint Swithins Lane. The New York office is at 10 Wall street.

The bank was constituted in 1890 under a concession from the Volksraad of the late South African Republic; at the conclusion of the South African war

—in 1902—the concession was abandoned and the continued incorporation of the bank provided for by an order in council of the British Government passed in August of that year. At that date the capital of the bank was \$5,500,000 (£1,100,000) with power to increase to \$20,000,000 (£4,000,000). Twenty-five hundred shares are held by the Government who thus have a direct interest in the bank. Under progressive management the bank made steady growth and in 1910 purchased the business of The National Bank of the Orange River Colony, an institution which had been in existence for over thirty-two years and had a considerable number of branches and a very



National Bank of South Africa, Ltd., Simmonds Street Branch, Johannesburg

firm hold in the banking business in the Orange River Colony. The purchase price was \$2,013,750 (£402,750). A considerable portion of the amount was paid out of profits and the remainder was written off by annual instalments. The acquisition of this valuable business did not involve the issue of further capital, which remained the same until 1912, when arrangements were come to for the acquisition of The Bank of Africa, Ltd. The Bank of Africa, Ltd., was an institution established in 1879 and had sixty-three branches, principally in the Cape and Rhodesia. The purchase of this bank necessitated the increase in the capital of The National Bank to \$11,750,000 (£2,350,000 in £10 shares) fully paid. On this date the total capital and re-

erves were \$13,600,000 (£2,720,000).

The number of offices at the end of 1911 amounted to 137, but after the absorption of the business of the Bank of Africa, which gave The National Bank a valuable hold on business in the Cape Province and Rhodesia, the number of offices open in 1913 exceeded 200.

A further expansion took place in 1914 when The National Bank purchased the old-established business of The Natal Bank, Ltd. The Natal Bank, Ltd., had been established for sixty years, were bankers to the Government in the Province of Natal, and had a number of branches and good connections throughout that province. The absorption of this business made it necessary to further increase the capi-



National Bank of South Africa, Ltd., Natal Bank Branch, Johannesburg

tal, which now stands at \$14,250,000 (£2,850,000) with a reserve fund of \$3,500,000 (£700,000).

The bank now has a firm hold on the business in every province of the Union of South Africa, Rhodesia and Portuguese East Africa.

The business of the bank, apart from the amalgamations with other banking institutions, has shown remarkable progress. The number of branches and agencies is now 306. A progressive statement of the principal figures in connection with the bank's business is given herewith. The capital and reserves of the bank will illustrate the recent expansion in the bank's business (£ calculated at \$5.00).

CAPITAL AND RESERVES		
1893	\$2,528,915	£505,783
1900	5,744,500	1,148,900
1905	6,150,000	1,230,000
1912	13,600,000	2,720,000
1915	16,537,100	3,307,420
1916	16,565,200	3,313,040
1917	17,750,000	3,550,000

Deposits constitute an important feature of a bank's business, and their growth is an indication of public confidence in the institution. As will be seen, The National Bank of South Africa figures show a very healthy position.

DEPOSITS		
1893	\$6,728,905	£1,345,781
1900	5,941,145	1,188,229
1905	39,107,425	7,821,485
1912	82,118,280	16,423,656
1915	104,163,110	20,832,622
1916	121,215,985	24,243,197
1917	136,232,505	27,246,501

*South African War period.



National Bank of South Africa, Ltd., Central Branch, Commissioner Street, Johannesburg

NOTE CIRCULATION

Every effort has been made to encourage the use of notes in South Africa in view of the importance of economizing in the use of gold. The success which has attended these efforts is shown in the progressive totals of the bank's note issue.

1893	\$496,860	£99,372
1900	1,392,790	278,558
1905	1,460,375	292,075
1912	4,051,225	810,245
1915	5,818,705	1,163,741
1916	6,231,415	1,246,283
1917	8,946,935	1,780,387

The cash assets of the bank, which include coin in the bank's coffers, cash with bankers in London, investments at call and money in London, show a strong percentage to the demand li-

abilities, indicating the liquid nature of the assets. The progressive figures are as shown herewith:

	CASH ASSETS	
1893	\$5,313,490	£1,062,698
1900	5,882,835	1,176,567
1905	19,654,570	3,930,914
1912	26,737,430	5,347,486
1915	43,847,780	8,769,556
1916	46,660,640	9,332,123
1917	53,849,365	10,769,873

On March 31, 1917, the liquid assets of the bank represented fifty-three per cent. of the liabilities to the public, an eminently satisfactory position.

HIGH RANK AS A COLONIAL BANK

The National Bank ranks as one of the premier British colonial banks; it has important connections throughout



National Bank of South Africa, Ltd., Strand Street Branch, Cape Town

the world and has a well established position among the large and powerful institutions which are a feature of British colonial banking.

A number of the important buildings which have been erected to accommodate the bank's growing business are shown in accompanying illustrations.



National Bank of South Africa, Ltd., Pritchard Street Branch, Johannesburg



National Bank of South Africa, Ltd., St. George's Street Branch, Cape Town



National Bank of South Africa, Ltd., Durban Branch

In many towns in South Africa the National Bank offices, situated in the centre of the commercial activities of the place, are a prominent local architectural feature. The bank has opened seven branches in the occupied German territory in West Africa, the chief offices being Windhuk, Luderitzbucht and Swakopmund. Branches have also been opened in the East Coast at Dar-es-Salaam and Tanga, also in British East Africa at Mombasa and Nairobi. The administration of the bank closely watches trade developments in Africa

and the rapid progress of new commercial and mining centres is marked in its early stages by the opening of a banking office by the National Bank of South Africa, Ltd.

THE MANAGEMENT

The Hon. Hugh Crawford, who is chairman of directors, has a long and honorable record in South Africa as a public servant. He was a member of the Legislative Council for some years, and is known and respected in all commercial circles.



National Bank of South Africa, Ltd., Natal Bank Branch, Durban

Mr. Edward Charles Reynolds received his early training with the London and Westminster Bank, Ltd. (now London County and Westminster Bank Ltd.) and has been in the service of the National Bank of South Africa, Ltd., since the institution was founded. He assumed the general managership of the bank at the end of 1909, and is closely identified with the rapid progress made since that date. He has built up a reputation for being a far-seeing and progressive banker, indefatigable in his efforts to further the interests of the bank. He is assisted in his duties by Mr. William Dunlop, who prior to his appointment as assistant general manager was associated for many years with the bank's business in Johannesburg and the important and wealthy gold mining interests whose activities

centre there. In 1915 Mr. Reynolds visited New York and arranged for the opening of an agency of the bank at 6 Wall street, under the able and progressive management of Mr. Robert Eaton Saunders.

Mr. Saunders has had wide experience in South Africa, New York, London and the European continent, of a character especially qualifying him as branch manager of an important institution like the National Bank of South Africa, and his knowledge and judgment, combined with unflinching courtesy, have already placed the New York Agency in a strong position. Mr. Saunders is ably assisted by Mr. W. L. Trumble, who has been in the bank's service over twenty years, chiefly in the London and South African offices.

The progress of New York Agency has



National Bank of South Africa, Ltd., Port Elizabeth Branch

been rapid and the bank has been obliged to move into larger and more commodious premises on the first floor of 10 Wall street. In London the bank has two offices; the chief office is in Circus Place, London Wall, where a large staff is employed. The manager, Mr. Douglas Cunningham, is well known in City circles, is on the council of the Institute of Bankers, and ably controls the bank's large interests in that city.

THE BANK'S PRESENT POSITION

The last report and balance-sheet submitted to the shareholders this year shows that the deposits of the bank have reached the total of \$136,230,000 (£27,246,000), which is in excess of

any other institution doing business in South Africa. The gross profit was \$5,174,620 (£1,034,924), which after deduction of expenses, including provision for all contingencies, leaves a balance of \$2,093,170 (£418,634) for distribution; \$847,500 (£169,500) was paid in dividends to shareholders at the rate of six per cent.; \$875,000 (£175,000) was placed to reserve fund; \$125,000 (£25,000) to pension fund, and \$245,670 (£49,134) was carried forward to next year.

GENERAL BUSINESS OUTLOOK IN SOUTH AFRICA

In his speech to the shareholders on the 22nd June, this year, the Hon. Hugh



London Office,
National Bank of South Africa, Ltd.

Crawford, chairman of the board of directors, after drawing attention to the various points in the balance-sheet, dealt with the outlook in South Africa. Mr. Crawford said:

“It is customary on these occasions to attempt a brief review of the general situation in South Africa, and in following this precedent I first desire to remark upon the prosperous condition



National Bank of South Africa, Ltd., East London Branch

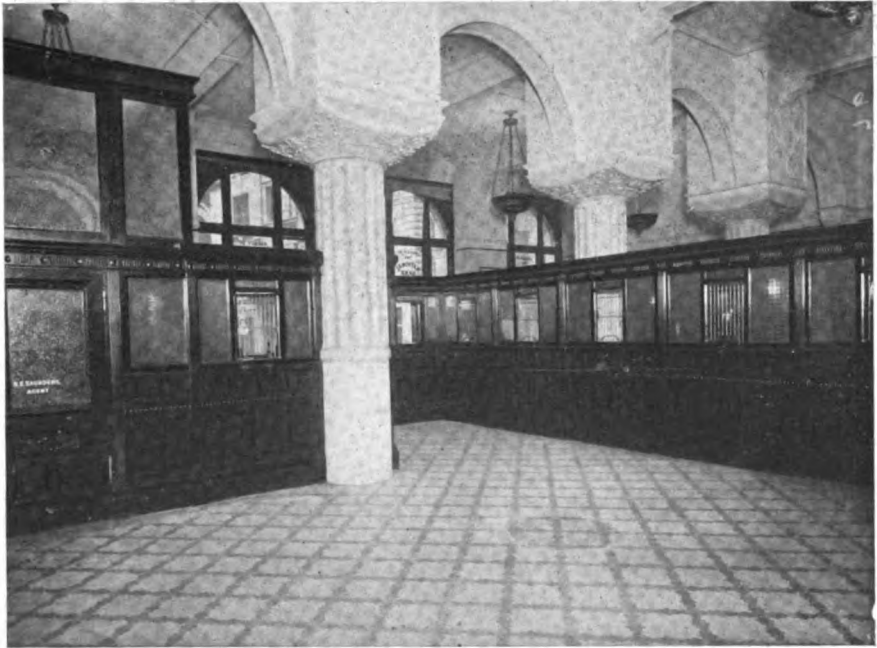

National Bank of South Africa, Ltd., Main Banking Room, New York Agency

of the country's trade. So far it has not suffered; on the contrary, producers have, as a result of the war, been obtaining quite exceptional prices. As evidence of the flourishing state of trade, I may point out that at December 31 last deposits with the South African Banks amounted to no less than £55,000,000 as against a total of £45,000,000 as at December 31, 1913—a striking comparison when we take into consideration the large sums which have left South Africa for investment in War Loans oversea and the success of the last Union Loan, which produced nearly 4½ millions new money. Scarcity of ocean freight is, however, having an embarrassing effect on both exports and imports.

“The price of nearly all commodities has reached a high level and, in some quarters, a sharp reaction upon the cessation of hostilities is predicted, while in others the view is held that there will be no sudden slump in prices. In all probability an era of prosperity will outlast the war for perhaps two or three years, to be followed, however, by re-

action when supply again begins to overtake demand. In the meantime our productive powers are being steadily developed. New industries are springing up in various parts of the Union, and in many instances the establishment of one fresh enterprise brings about the inauguration of several dependent undertakings; all this makes for progress of the most natural and healthy kind and gives us encouragement to believe



National Bank of South Africa, Ltd.,
Lourenco Marques Branch



National Bank of South Africa, Ltd., Private Office of R. E. Saunders, New York Agent

that after a long era of experiment we are at last commencing to develop our resources in earnest.

"The gold mining industry still takes pride of place and its outlook is healthy. The Union's output for 1916 was £39,489,774 as against £38,627,461 in 1915. Notwithstanding the greater output, the dividends, in the aggregate, were less than in the previous year. Increased working costs, attributable to war conditions, have set a serious problem for the lower grade mines, but increasingly efficient methods go a long way towards counteracting this adverse factor. Several new areas have been given out on lease by the Government during the year and very satisfactory results have been attained at the newer mines on the far East Rand. Diamond mining has revived and the prices realized for diamonds must be deemed very satisfactory. Tin was produced in the Union to a value of £356,447, as compared with £340,428 in 1915. The industry, while having disappointed the optimistic estimates of a few years ago,

is still an important one in which great hope is placed. Copper remains in good demand and has been produced to a value of £1,132,140 as against £817,793 in 1915. The Union's output of coal amounted to over 10,000,000 tons, valued at £2,715,313, which figures show substantial increase when compared with those for 1915. Freight difficulties have interfered somewhat with the export trade, but the falling away in this respect has been more than made up by the greater demand for bunker coal. Regarding the farming industry and to refer first to wool, I would remind you that a year ago we thought the price had attained an almost inflated point, but the year with which we are dealing has seen continued advancement. The quantity exported in 1916 was valued at £6,601,657, as against £5,380,031 in 1915. Restricted shipping facilities and the consequent accumulation of wool at our ports have imposed no inconsiderable strain on merchants and institutions connected with the financing of this branch of our



National Bank of South Africa, Ltd., Public Space, New York Agency

export trade. Mohair was exported to a value of £1,115,685. The production of ostrich feathers—once such an important industry—is an enterprise concerning which it is still impossible to chronicle progress. As this product is not only a luxury but one, the demand for which is governed by the capricious decrees of fashion, it is difficult to predict its immediate future, but so beautiful is the article that surely it must eventually regain its popularity. Meanwhile it is unfortunate that those who have specialized in this branch of farming do not seem to have shared in the welcome rains which have visited most other parts of the Union. Their efforts to otherwise turn their land to account must thereby have been partially frustrated. It would be imprudent to hazard a guess as to the value of the maize crop, but ultimately it must reach gigantic figures.

“To-day private enterprise is yielding large results, but when capital becomes available for the more extensive conservation of moisture there will, I am

convinced, be further development in the farming industry. The capital expenditure necessary to lead to the great attainments of which the land is capable will, however, be heavy, and the task is one for Government rather than for private enterprise. In regard to the maize export trade, fortunately for the farmers the Imperial Government has arranged to provide shipping facilities. The growth of wattle bark is an industry upon which we have in the past built great hopes, but here again freight disabilities have interfered. But they have brought compensation, as witness the efforts of those enterprising, and I am happy to say, successful people who have provided in Natal a plant for the extraction of tannin. This plant is already of great benefit and will when extended be of much greater importance to the large wattle growing tracts of Natal and part of the Transvaal. Fruit growers have also suffered and must for a time, I fear, continue to suffer from restricted opportunities of securing freight to the great markets over-

sea. They need, however, not be discouraged. They have already studied to some purpose the requirements of these markets and with the restoration of normal conditions rapid strides should be made. Meanwhile it would not, I think, be inappropriate to turn attention to the canning and drying of fruit, an industry which, as I pointed out last year, seems one naturally to be engaged in because we have the sugar farmer at our door. Sugar planters continue to do well and to have excellent prospects. The country has great hopes for this industry and confidence in those directing it. The export of meat, commenced as an experiment a year or so ago, promises to develop into a most important industry, and our stock farmers are indebted to the enterprise which has provided them with an avenue to the markets oversea. We have great opportunities for developing this trade and there are signs that we are not neglecting to avail of them. In recent years animal life has hardly kept pace with human consumption, and at least one country which formerly exported beef on a large scale has now to import.

"The resources of South Africa have, however, scarcely been tapped by the markets of the world and it has been estimated that the annual increase leaves a large surplus available for export. Scientific breeding will, moreover, speedily yield great improvement in quantity and grade. Mention was made at our meeting last year of the projected manufacture of ammonium sulphate, and I am pleased to say that production has become an accomplished fact. To sum up, I am fully convinced that prosperity lies before us, although in these times it is difficult to discern what the immediate future has in store. For a time our trade may be hampered by the conditions of war which, for some time, have been more severely limiting freight facilities. We shall, however, have to endure this temporary inconvenience, and the lack of certain commodities formerly imported from oversea may cause us to investigate our resources and to devise substitutes. In

the same way should exportation of certain of our products be restricted, we may learn to more largely turn our raw material to account in South Africa.

"With the restoration of peace there are, I think, likely to be introduced many improvements in the commercial and social life of the great Empire of which we are a unit. There will, I feel, be greater sympathy and less distinction between the richer and the less fortunate classes. There will, let us hope, be increased opportunity for scientific education, although this may mean less time for the classical subjects now so universal in our colleges. Last year I referred to the decimal system and the metric system of weights and measures, advocating the adoption of both. I preserve the same mind on this subject and again plead for the change as a time and labor saving measure and one calculated to facilitate commercial intercourse with other nations."

AN INSTRUMENT OF TRADE

Through its extensive local and foreign connections The National Bank of South Africa, Ltd., has been an important instrument in the development of home and outside trade. In both fields there is a growing opportunity for rendering even greater service, and wise provisions are made from time to time to meet these enlarged requirements. How effectively the bank has met past demands upon its facilities may be seen from the figures already quoted, and what has been done affords the best assurances for the future. The management fully realize, however, that such great changes are going on in trade and banking that to meet the needs of the times will require unusual alertness. Fortunately, the capital equipment of the bank is large and the experience already gained such as should be of great value in dealing with future problems as they arrive. While aiming to supply all proper demands for banking extension, the policy of maintaining a proper proportion of capital and reserves to general liabilities and of keep-

Banking and Financial Notes

AMERICAN FOREIGN BANKING CORPORATION

At a recent meeting of the board of directors of the American Foreign Banking Corporation, of New York, A. H. Wiggin was chosen chairman of the board of directors, Archibald Kains, president; Hayden B. Harris and T. Fred Aspden, vice-presidents, and C. A. Mackenzie, treasurer and secretary.

The new corporation will operate under the regulations of the Federal Reserve Board.

Officials of prominent banks located in various parts of the country are represented on the board of directors, mak-

ing it an exceptionally strong corporation. Following are the directors: T. Fred Aspden, vice-president American Foreign Banking Corporation, New York City; Gerhard M. Dahl, vice-president Chase National Bank, New York City; Norman H. Davis, president Trust Company of Cuba, New York City; C. L. Farrell, president Essex County National Bank, Newark; Ernest A. Hamill, president Corn Exchange National Bank, Chicago; Hayden B. Harris, vice-president American Foreign Banking Corporation, New York City; C. A. Hinsch, president Fifth-Third National Bank, Cincinnati; W. R. Irby, president Canal Bank and Trust Company, New Orleans; C. T. Jaffray, president First and Security National Bank, Minneapolis; Archibald Kains, president American Foreign Banking Corporation, New York City; John G. Lonsdale, president National Bank of Commerce, St. Louis; Levi L. Rue, president Philadelphia National Bank, Philadelphia; John Sherwin, president First National Bank, Cleveland; E. V. R. Thayer, president Merchants National Bank, Boston; Fred Vogel, Jr., president First National Bank, Milwaukee; Albert H. Wiggin, president Chase National Bank, New York City, and H. B. Wilcox, vice-president Merchants-Mechanics First National Bank, Baltimore.



Mr. Branch
Our first President

Merchants National Bank

RICHMOND, VA.

Capital \$400,000
Surplus and Profits over 1,000,000

The Gateway to and Collection
Center for Southeastern States

Send Us Your Items

"ON TO RICHMOND"

CHANGES IN THE CHEMICAL NATIONAL BANK

Percy H. Johnston, vice-president of the Citizens' National Bank, of Louisville, Ky., has been elected vice-president and director of the Chemical National Bank, of New York. Francis Halpin, formerly cashier, and I. B. Hopper, formerly assistant cashier, were also elected vice-presidents. Edward H. Smith, assistant cashier, was appointed cashier, to succeed Mr. Halpin,



The Chemical National Bank of New York

(Established 1824)

Capital, Surplus and Undivided Profits, \$11,000,000

Co-operation with Banks

Early in its history this institution, through its conservative policies, won the confidence and patronage of other banks.

Unbroken adherence to this conservatism throughout the almost one hundred years of our existence has drawn to us a Banking clientele of the highest order, to whom we offer banking facilities and service of an exceptional character.

Interest paid on balances of Banks, Time Deposits, and Special and Reserve Accounts.

Correspondence solicited

H. K. Twitchell, President
Percy H. Johnston, Vice-President
Francis Halpin, Vice-President
I. B. Hopper, Vice-President
E. H. Smith, Cashier

James L. Parson, Assistant Cashier
J. G. Schmelzel, Assistant Cashier
John B. Dodd, Assistant Cashier
Samuel T. Jones, Assistant Cashier
H. M. Rogers, Mgr. Foreign Dept.

DIRECTORS

Frederic W. Stevens
W. Emlen Roosevelt
Robert Walton Goelet

Charles Cheney
Arthur Iselin
Frederic A. Juilliard

Ridley Watts
Herbert K. Twitchell
Percy H. Johnston

and John B. Dodd and Samuel T. Jones were appointed assistant cashiers.

COMMENTS ON PRICE FIXING BY LAW

A recent issue of the financial and business letter of the Mechanics and Metals National Bank of New York contains a discussion of the price fixing by law. The bank says:

"Government price regulation has given us one of the most important and intricate problems which American industry has ever been obliged to face, and whatever form or extent the federal control of staples essential for war may finally assume, it would seem that sweeping readjustment of normal commercial relations is inevitable. Readjustments will not be brought about simply. For beyond the government's own necessities, which prompted the price-fixing under federal control, the matter concerns the outside market whose prices otherwise would be determined by the free play of the supply and demand of given commodities. Fed-

eral control of certain staples that remain to be offered after government necessities are filled, particularly if those staples are restricted and inadequate to meet the total demand, will involve many problems and bring about manifold complications. Then, too, the matter of fixing prices of the products of labor, without at the same time exercising control over the price of labor itself, is destined to create problems, more or less serious according to circumstances, for settlement.

"Unfortunately, precedents offer no guidance whatever. The iron, steel, copper and coal industries, like the food industry, are moving in new and unknown grounds. The old grounds were charted and known; on those grounds industry had been built to the position it occupies to-day. But now an entirely new order of affairs obtains. In the last analysis, the success of the new departure rests altogether upon the spirit in which the readjustments are made. Prices that are not subversive,

**The
National Shawmut Bank
of Boston
Service**



Departments:
Banking Trust
Foreign Transfer
Investments Safekeeping

The dominant idea in every department of this institution is service—courteous, intelligent, willing service.

Your Account Invited

but that stimulate growth and act as an incentive to effort by allowing an adequate return on capital invested, will make for success of the plan. Anything else will fly in the face of sound economic principle and operate to defeat the plan."

BECOMES DIRECTOR MECHANICS AND METALS

F. W. Roebing, Jr., treasurer of J. A. Roebing Sons' Company, of New York, has been elected a director and a member of the Executive Committee of the Mechanics and Metals National Bank, of New York.

E. V. R. THAYER PRESIDENT CHASE NATIONAL

Eugene V. R. Thayer, president of the Merchants National Bank, of Boston, was elected president of the Chase National Bank of New York. Mr. Thayer will succeed Albert H. Wiggin, who will become chairman of the board of directors, which position has been made vacant by the resignation of A. Barton Hepburn.

Mr. Hepburn resigned as chairman of the board to take effect January 1, 1918. Mr. Hepburn feels that he has earned a respite from routine work and makes this change in order to have more leisure for the things he wishes to do. He remains as a director, retains his stock holdings and will have the same interest and ambition in the future growth and prosperity of the Chase as he has had in the past. Mr. Wiggin is the third chairman of the

board of the bank, the Chase National Bank having been one of the first corporations to establish this office. Mr. Hepburn's predecessor in this office was Henry W. Cannon. Mr. Wiggin, like his predecessor, will continue to make the office an active one.

The senior officers, Messrs. Hepburn, Wiggin, Thayer, Miller, Tinker, Schmidlapp, Dahl and Andrews were constituted an advisory board. Mr. Hepburn was made chairman of the same, so that the Chase National Bank will continue to have the benefit of his counsel and advice.

Mr. Thayer is now president of the Merchants National Bank of Boston, one of the leading institutions in New England, a position which he has occupied for six years. He has long been prominent in the affairs of his native city and is too well known to the business world to need additional comment. Mr. Thayer will also be a director and vice-president of the Chase Securities Corporation.

CHANGES IN AMERICAN EXCHANGE NATIONAL BANK

At a recent meeting of the board of directors of the American Exchange National Bank of New York, L. S. Tieman and M. P. Moseley were elected vice-presidents. Mr. Tieman was formerly assistant cashier and was at one time a member of the firm of Carlton and Moffat. Mr. Moseley is a newspaper man and was president of the New York Commercial.



100 YEARS OF COMMERCIAL BANKING

LOUIS G. KAUFMAN
President

FRANK J. HEANEY
Vice-President

WILLIAM H. STRAWN
Vice-President

NORBORNE P. GATLING
Vice-President

H. A. CLINKUNBROOMER
Vice-President

ROLFE E. BOLLING
Vice-President

WALLACE T. PERKINS
Vice-President

WALTER B. BOICE
Asst. Cashier

VINTON M. NORRIS
Asst. Cashier

RICHARD H. HIGGINS
Vice-President

BERT L. HASKINS

Vice-Pres. and Cashier

C. STANLEY MITCHELL
Vice-President

MAX MARKELL
Vice-President

GEORGE R. BAKER
Vice-President

HENRY L. CADMUS
Asst. Cashier

HENRY C. HOOLEY
Asst. Cashier

JOSEPH BROWN
Asst. Cashier

GEORGE M. HARD
Chairman

ACCOUNTS INVITED

Resources Ninety-six Million Dollars

THE GUARANTY NEWS

The patriotic number of the Guaranty News, which is the publication of the Guaranty Club of the Guaranty Trust Company of New York, contains a number of extracts from the diary of an American Ambulance Driver at the French front. These are taken from the diary, of J. G. B. Campbell, of the foreign department of the bank, written during the year 1916 when he was driving an ambulance for the American Ambulance Section No. 1. Regarding the Germans' blind obedience to duty, Mr. Campbell writes:

"One story shows the Germans' absolute, blind obedience to duty. In a *poste d'écoute* a French *caporal* found by listening to the voices in the German post, that he knew one of the men. He called out, and the answer showed that he was right. In front of him was a German who had worked with him in Paris, and with whom he had been very friendly. They went up on the parapet and had a long talk. When relieved, the Frenchman reported to his Colonel, and was ordered to try to get some information from the German. Charged with that mission, he called out to his friend on the following night, who answered that he had reported the incident, and was ordered not to hold any more converse

and to shoot on sight. The Frenchman said, "You would not shoot an old friend. I am coming over to see you." The German called back, "Don't show yourself; I must shoot." The Frenchman did not believe it possible, and got up on the parapet, and was killed at once. Every Frenchman there, remarking on the story, said he would have disobeyed orders and would not have shot his friend. There is a lot in that story."

REPORT OF HANOVER NATIONAL BANK

As of September 11, 1917, the Hanover National Bank of New York showed total resources of \$199,392,499.82 and deposits of \$171,797,179.42. United States deposits amounted to \$4,661,000.00. Loans and discounts were \$122,571,967.63. The bank has a capital stock paid-in of \$3,000,000, a surplus fund of \$14,000,000, an undivided profits less expenses and taxes paid \$2,924,734.54.

ADDRESS ON BUSINESS AND FINANCE

Francis H. Sisson, vice-president of the Guaranty Trust Company of New York, on September 19, 1917, made an address before the Illinois Bankers' Association at Quincy on "Over the Top" in Business and Finance." Re-

National Bank of Commerce in New York

PRESIDENT
JAMES S. ALEXANDER

VICE-PRESIDENTS
R. G. HUTCHINS, Jr.
HERBERT P. HOWELL
J. HOWARD ARDREY
STEVENSON E. WARD
JOHN E. ROVENSKY
GUY EMERSON

CASHIER
FARIS R. RUSSELL



AUDITOR
A. F. JOHNSON

ASSISTANT CASHIERS
A. J. OXENHAM
WILLIAM M. ST. JOHN
LOUIS A. KEIDEL
A. F. MAXWELL
JOHN J. KEENAN
GASTON L. GHEGAN
A. F. BRODERICK
EVERETT E. RISLEY
H. P. BARRAND
R. W. SAUNDERS
H. W. SCHRADER
R. E. STACK

MANAGER FOREIGN DEPARTMENT
FRANZ MEYER

CAPITAL, SURPLUS AND UNDIVIDED PROFITS OVER \$45,000,000

garding the lessons of the war, Mr. Sison says:

"These lessons are obvious to us all; thrift in place of waste, simplicity instead of self-indulgence, respect for authority in place of careless anarchy, patriotism instead of localism, breadth instead of narrowness, service instead of selfishness. If these be a part of the harvest of war, whatever be its cost, it will not have been in vain, and it will have paved the way for better days to come. If we can learn that neither money nor power are sufficient things in themselves for men to live for or die for; that, after all, the greatest sense of achievement comes in the triumphs of spirit in a righteous cause, our dead will not have died for naught."

STATEMENT OF GUARANTY TRUST

Total resources of \$613,535,033.59 are shown by the financial statement of the Guaranty Trust Company of New York, as of September 8, 1917, which has just been issued. Deposits on that date totaled \$503,804,200.85.

Comparison of these figures with those of September 20, 1916, shows an increase of \$98,361,331.89 in resources, and of \$86,355,190.69 in deposits, in a little less than a year.

In January, 1915, when Charles H. Sabin became president of the Guaranty Trust Company, its total resources were somewhat over \$269,000,000, and its

total deposits a little more than \$211,000,000.

The remarkable deposit growth of this company is clearly indicated in the following table taken over a two-year period:

Deposits September 25, 1915	\$323,390,925
Deposits September 20, 1916	417,449,010
Deposits September 8, 1917	503,804,200

PROMOTION FOR JOHN A. TERRACE

John A. Terrace was recently appointed an assistant manager of the foreign department of the Guaranty Trust Company of New York, with which institution he has been connected since March, 1916. Before coming to New York he was acting manager of the Royal Bank of Canada, in Montreal, and prior to that was with the Bank of Scotland in Edinburgh and London. Mr. Terrace is thirty-four years of age, and was born in Dysart, Scotland.

ADDRESS ON INFLUENCE OF WAR AND TRADE

G. A. O'Reilly, foreign trade representative Irving National Bank, New York, delivered an address before the National Petroleum Convention at Atlantic City on September 13, 1917, on the influence of the war on domestic and foreign trade. Regarding the war's bearing upon future trade, Mr. O'Reilly said:

This, then, is the theory I would submit concerning the war's bearing upon the future of our trade: First of all, we must be prepared

Service

The Citizens National Bank of New York for sixty-six years has specialized in accounts of merchants, and is located in the heart of the district where the largest part of New York's mercantile business is transacted.

We are thoroughly equipped to render the best of service to correspondent banks covering their requirements of every nature in New York.

THE CITIZENS NATIONAL BANK OF NEW YORK

Capital, Surplus and Undivided Profits \$5,000,000

EDWIN S. SCHENCK, President

FRANCIS M. BACON, JR., Vice-Pres.
ALBION K. CHAPMAN, Cashier
JESSE M. SMITH, Asst. Cashier

GARRARD COMLY, Vice-Pres.
JAMES MCALLISTER, Asst. Cashier
WILLIAM M. HAINES, Asst. Cashier

to depend upon ourselves exclusively. After the war, our best friends among the nations, whatever their disposition towards us, will be kept quite busy attending to troubles of their own.

Next—we must nationalize our foreign commercial theories and in order to do this effectively we must educate our people at home to a full realization of the meaning and value of nationality as applied to commercial methods. Then, we should capitalize our American characteristics, just as we would capitalize any other available asset and, after that, drive into the consciousness of the foreigner the fact that we and our methods, including our perhaps amusing characteristics are to be taken seriously—and that if he is to proceed safely, he must include in his business theories a healthy respect for American spheres of influence; American tone, and above all, American nationality.

WILL CLEAR THROUGH FEDERAL RESERVE

The Guaranty Trust Company has arranged to make its daily clearing house settlement through the Federal Reserve Bank of New York.

Within the last few months a number of other institutions which, like the Guaranty, are not members of the Federal Reserve System, have opened similar accounts for the handling of their clearing house balances. Such funds kept with a Federal Reserve Bank are

considered a part of the depositing bank's legal reserve. This arrangement also obviates the necessity of transporting millions of dollars through the streets each day.

L. E. PIERSON ON TRADE ACCEPTANCES

One of the first bankers in New York to take up the discussion of trade acceptances and one who is considered now an authority on this matter, L. E. Pierson, chairman of the board of Irving National Bank of New York, recently made another speech on acceptances before the War Convention of American Business held at Atlantic City. Mr. Pierson's former treatise has been published by the bank.

In his recent address, Mr. Pierson makes the following suggestion:

Taking the five great cereal crops the government full benefit from the action of this convention in its behalf, and to establish a nationally representative center in which its interest constantly may be promoted, it is suggested that the Chamber of Commerce of the United States be requested to appoint a committee of three persons to work, jointly if possible, with similar committees of the American Bankers'



THE need of a good New York
Banking Connection is great to-
day—perhaps greater than ever before.

ATLANTIC NATIONAL BANK

257 BROADWAY, NEW YORK

CAPITAL, SURPLUS AND UNDIVIDED PROFITS \$1,800,000

RESOURCES OVER \$20,000,000

Association and the National Association of Credit Men to the end that the trade acceptance may be established in business practice throughout the country.

ELECT DIRECTOR GUARANTY TRUST

Hon. W. Murray Crane, former United States senator from Massachusetts, was elected a director of the Guaranty Trust Company of New York at a recent meeting of the board of directors of that institution.

IRVING BANK INCREASES CAPITAL

At a recent special meeting of the stockholders of the Irving National Bank of New York it was voted to increase the capital stock from \$4,000,000 to \$4,500,000. This is one of the steps in the joint stockholding agreement between the Irving National Bank and the Broadway Trust Company of New York. The new stock will be sold at \$150 and the privilege of purchase will be offered to stockholders on the ratio of 3 to 1 according to the agreement which states that the stock of the two companies must be held on that ratio.

REPORTS CROP CONDITIONS

The September 15, 1917, financial letter of Knauth, Nachod and Kuhne of New York takes up in a concise and businesslike manner the investment situation throughout the country. Regarding the crop conditions, the letter says:

Taking the five great cereal crops the government figures suggest a total yield this year of 5,709,000,000 bushels as against a total production last year of 4,703,000,000 bushels. This shows a gain for the year of at least one billion bushels for the five great crops with a total money value far in excess of that reported at this season in any previous year. The figures show that there is little chance for a shortage of cereal food in the United States this year. As to the extent of the export balance, it is clear that that will depend largely on the willingness of the people to continue to economize in the use of wheat. With \$2 a bushel assured for next year's crop the American farmers may be expected to sow the greatest wheat crop ever raised.

A TRIP THROUGH A TANNERY

Number Eight of the monthly magazine devoted to the interests of the City Bank Club of the National City Bank of New York, contains a good article on a trip through a tannery by James Mathews, assistant cashier. The article

is so written that without difficulty the more technical points may be understood and it unquestionably covers an industry about which little is known in banking circles.

BECOMES OFFICER GUARANTY TRUST

At a meeting of the executive committee of the Guaranty Trust Company of New York, on September 17, Rowland E. Cocks was appointed an assistant trust officer.

Mr. Cocks began his employment with the Guaranty Trust Company as messenger in December, 1904. He was made head of the individual trust division of the trust department four years ago and remained in this position until his present promotion.

**E. P. TATE BECOMES ASSISTANT
TREASURER**

One of the appointments made recently by the Guaranty Trust Company of New York is that of Edmund Parker Tate, who became an assistant treasurer of the company on September 13. Mr. Tate has been associated with the Guaranty since 1905, having entered the



EDMUND P. TATE
Assistant Treasurer Guaranty Trust Company,
New York City

Resources

\$15,000,000.00

If intelligent handling of items and low rates appeal to you send us your Buffalo business



Try our Service
and you will be entirely
satisfied

A. D. BISSELL, President
C. R. HUNTLEY, Vice-Pres.
E. H. HUTCHINSON, Vice-Pres.
E. J. NEWELL, Vice-Pres.
HOWARD BISSELL, Cashier
C. G. FEIL, Asst. Cashier
A. J. ALLARD, Asst. Cashier
G. H. BANGERT, Asst. Cashier

GROWTH --- ONE YEAR

DEPOSITS

September 8, 1917 . . . \$14,804,336.00

September 20, 1916 . . . 7,484,024.00

INCREASE . . . \$7,320,312.00—97%

Citizens Commercial Trust Company
BUFFALO, N. Y.

institution at the age of fifteen as a messenger. He was successively a member of several departments and on January 31, 1915, became purchasing agent, a position in which he achieved signal success.

He was appointed chief clerk of the company in September, 1916, and developed the chief clerk's department from a small organization to one with a staff of twenty-five members, and activities which reach out into every phase of the company's business.

In Mr. Tate's new position he will have charge of the entire clerical organization of the Foreign Department which includes three hundred employees. He will have special jurisdiction over the accounting and collection divisions; and will assist in the educational work of the whole department.

For the past year he has also been president of the Guaranty Club, an organization composed of the company's eighteen hundred employees.

POINTS OUT DUTY OF ALL BANK MEN ON LIBERTY LOAN

"The M. and M. Journal," which is the monthly publication of the employees of the Mechanics and Metals National Bank of New York, contains in its September number a most timely article on the duty of bank officers and bank clerks in helping the nation during war. The article says:

The premier duty of every bank man, from officer to office boy, is then to become a volunteer salesman of Government bonds. Utilize every opportunity of making a sale and let not an opportunity of getting the bonds a little publicity pass untaken. Interest your fellow

passengers in a railroad train, talk about it to the person sitting beside you in the elevated, subway or trolley. By so doing remember that you are doing a patriotic and by no means invaluable service to your country, and are affording yourself worthwhile training and experience along lines that all would-be bankers must familiarize themselves.

BANKER ISSUES WAR HELP CALL

Major Grayson M. P. Murphy, vice-president of the Guaranty Trust Company of New York, and now serving as head of the Red Cross Commission in France, recently cabled a call for supplies. He urged the knitting of sweaters, mufflers, etc., stating that last winter all records for cold and misery among the people were broken.

CHANGES IN MERCANTILE TRUST AND DEPOSIT COMPANY

P. S. Duryee, formerly president of the firm of Duryee and Barwise, wholesale dealers in teas and coffees, and who has been in charge of the New York office of the Red Cross War Fund has been appointed assistant to the president of the Mercantile Trust and Deposit Company of New York. H. D. Campbell, formerly vice-president of Washington Savings and Loan Association of Seattle, has been appointed secretary and treasurer.

GUARANTY TRUST DIVIDEND

The Guaranty Trust Company of New York, at a recent directors' meeting, declared a dividend at the rate of five per cent. for the quarter ending September 30, 1917. At the same meeting T. E. Wilson, president Wilson and

DJÖRUP, EDWARDS & McARDLE

Bank, Commercial, and Foreign
Exchange Audits and Systems

42 BROADWAY

NEW YORK

Company, Chicago, was elected a director of the bank.

BANK OPENS BRANCH IN CONQUERED TERRITORY OF GERMAN EAST AFRICA

R. E. Saunders, manager of the New York agency, the National Bank of South Africa, has received cable advice from his head office that the bank has opened a branch at Tabora in the conquered territory of German East Africa. Tabora is an important distributing centre on the main caravan route to Lake Victoria Nianza. The Germans attach considerable importance to this town and also to Dar-es-Salaam and Tanga, where the National Bank of South Africa, Ltd., some time ago also opened branches.

"THE METTICO METEOR"

The September number of "The Mettico Meteor," which is published in the interest of employees of the Metropolitan Trust Company of New York contains an excellent article on the commercial resources of West Virginia, by Irwin G. Jennings. The article is well illustrated and shows the strength of the banks as well as business conditions.

MERCHANTS BANK PLACES STOCK IN VOTING TRUST

It has been agreed that interests in control of the Merchants National Bank of New York, will place their holdings in a voting trust which will run for five years and comprises 20,001 shares purchased by the Royal Bank of Canada and New York interests. The trustees of the trust will be J. R. Bruce and F. F.

Walker, New York agents of the Royal Bank of Canada, and Dean Sage of the firm of Zabriskie, Murray, Sage and Kerr. It is held that the trust agreement will insure the retention of the present management and will avoid possible future changes by the minority holders securing some of the stock now held by the majority.

INSURES EMPLOYEES

The Metropolitan Trust Company of New York has insured all of its employees with the Metropolitan Life Insurance Company under the continuing policy plan. The amount is the annual salary of each employee and premium payments are made by the trust company so that there is no charge to the employee. This plan embraces only those at the time in the employ of the bank and future employees must remain in the employ of the company for six months before they will be eligible for insurance.

REGULATION OF EXPORTS

All the vital features of Government export control, stripped of their legal verbiage so that the busy man may grasp them quickly, are explained in the pamphlet, "The Regulation of Exports Under the Espionage Act," issued by the Guaranty Trust Company of New York.

This pamphlet, which is of particular importance to those concerned in foreign trade, contains the list of articles which cannot be exported without licenses, and makes clear the restrictions



BERTRAM I. DADSON

Assistant Cashier Seaboard National Bank, New York

Mr. Dadson was born in Brooklyn in 1883. After graduating from Public School No. 15, Borough of Brooklyn, he attended the Boys' High School and entered the employ of the Seaboard National Bank as office clerk at the age of 15 years. He arose to the position of loan clerk, in which capacity he has served for the past ten years.



JAMES E. ORR

Assistant Cashier Seaboard National Bank, New York

Mr. Orr was born in Philadelphia and graduated from the public and high schools of the Borough of Brooklyn. He has been associated with the Seaboard National Bank for twelve years, entering as a messenger and working up through the various departments and, until recently, filled the position of chief clerk.

governing the two distinct classes of exports under Government regulation. One of these classes relates to the shipment of articles to the enemy and to European neutral countries; the other to certain commodities whose export is prohibited to countries other than those named in the first class. A list of destinations to which shipments are not permitted, and a list of those to which shipments are allowed under licenses, are included. How and where licenses may be obtained, and the nature of the information required to fill out the forms of application are also clearly outlined.

The Guaranty Trust Company announces that its Foreign Trade Division is prepared to furnish information relating to the new rulings and procedure

of the Exports Administrative Board as they are issued.

SUGGESTIONS IN REGARD TO LIBERTY LOAN

At a joint meeting of Groups I and II of the New York State Bankers' Association, last month, Elliott C. McDougal, president of the Bank of Buffalo, made the following suggestions in regard to the new Liberty Loan.

Whatever rate of interest or other conditions may accompany the new issue of Liberty Bonds, whatever may be our opinion as to the wisdom of such conditions, I am sure that we bankers will do our best to help our Government to sell the bonds. It is unnecessary for me to make any suggestions as to rates and conditions. The Secretary of the

Is It Not Sound Policy

to send your Baltimore business to the bank whose half century of experience gives assurance of efficiency and strength?

For the handling of collections and all other banking business, this institution is admirably equipped.

Large capital, surplus and resources enable this bank to offer you complete banking facilities and services which are real and not visionary.

The National Exchange Bank Baltimore, Md.

Capital & Surplus, \$2,480,000 Resources, \$12,048,000

WALDO NEWCOMER, President
SUMMERFIELD BALDWIN, Vice-Pres. CLINTON G. MORGAN, Cashier
JOSEPH W. LEFFLER, Asst. Cash. WILLIAM R. WEBB, Asst. Cash.

Treasury knows that he can have, for the asking, the advice and assistance of the very best bond houses and bankers in this country.

I shall make only two suggestions out of the many which occur to me.

First: Whatever may be the terms, conditions and requirements, they should be clearly outlined in advance; if possible, one month, and, in any event at least two weeks before the opening of subscriptions. Many think, with regard to the first issue of Liberty Bonds, that details could easily have been fixed and announced in advance. As the first issue was an experiment, there is room for honest difference of opinion on this point. With the experience of that campaign to guide the Treasury Department, with the best expert advice in this country at its service for the asking, there should be no difficulty in naming well in advance, exact terms, conditions and regulations. When these are named, they should be scrupulously adhered to. This would enable the bankers of this country to give to the public authoritative information and to answer

questions intelligently. In the first Liberty Loan campaign, this was impossible. Not only were bankers without instructions on many points, but, when they applied to the Federal Reserve Bank for authoritative rulings so that they could answer the questions asked by the public, they could not get replies that were either prompt or clear. Even admitting that this was excusable in the first attempt, it would be entirely inexcusable now.

Second: I suggest that every available agency be employed in the endeavor to reach the public. The most important Government agency for this purpose is its staff of postmasters. Many who would not buy bonds from a bank might buy them from a postmaster. The average postmaster is no busier than the average banker; in many cases he is not nearly so busy.

R. G. HUTCHINS WILL RETURN TO
UNITED STATES

It is announced that R. G. Hutchins, vice-president of the National Bank of Commerce in New York, who headed

ADRIAN H. MULLER & SON

55 WILLIAM STREET, Corner of Pine Street, NEW YORK

AUCTIONEERS

The Business of Banks, Bankers, Investors and Dealers in Securities generally, receives prompt and careful attention.

STOCKS AND BONDS AT AUCTION
REGULAR AUCTION SALES OF ALL CLASSES OF STOCKS AND BONDS EVERY WEDNESDAY

Real Estate at Public and Private Sale

Prompt Returns on all business entrusted to us

the mission to Russia sent by that bank will soon return to New York, having accomplished the purpose for which he went to Russia. H. P. Barrant, assistant cashier in the foreign department, will remain in Stockholm with other members of the bank's party until the Russian situation clarifies.

HOPEFUL OF COMING LIBERTY LOAN

Frank A. Vanderlip, president of the National City Bank of New York, recently speaking before the Bond Club of New York, stated that while the task of raising the next loan was tremendous, there was a better organization, and a well educated public. He stated that he was not a bit pessimistic about the loan no matter what the amount might be. Benjamin F. Strong, governor of the local Federal Reserve Bank, also spoke expressing the greatest confidence and stating that with the present workings of the Federal Reserve system there was little likelihood of an upset to money market conditions.

BANK REPORTS GENERAL CROP CONDITIONS

The National City Bank of New York, in its September business and financial letter, has an optimistic report of agricultural conditions throughout the country. The letter says:

The most important feature of the business situation is the gratifying progress made by the crops during the last month. The small grain is now harvested. Wheat is threshing out better than expected. Oats are a tremendous crop, big in yield and fine in quality, and barley and rye are good. Corn only wants to be let alone by the frost, to make a crop larger than the record by 300,000,000 bushels, and larger

than last year's by 800,000,000 bushels. Potatoes, beans, garden products and fruits will be in abundant supply. The pack of all kinds of canned and dried goods will be much larger than usual, but is being put up on a higher basis of costs than usual.

To sum up, the yield of agricultural products now promises to be large, and with prevailing prices the purchasing power of the agricultural districts in the coming year will be beyond all past experience.

This situation is very reassuring because it puts a solid basis under business for the coming year. It means that a great reserve of purchasing power exists in the country, more in fact than can be exercised with the present war requirements. It should put the farming industry permanently on a better basis financially. Moreover, although agricultural products will bring prices which, taken together with the large yield, will be very remunerative to the growers, the supply is sufficient to meet the needs of the population, and to give assurance that the necessities as a rule will not average higher than during the last year, and in most cases should be lower.

P. J. EBBOTT GOES TO PLATTSBURG

Percy J. Ebbott, assistant cashier of the National Park Bank of New York for the past two years, and also in charge of out of town bank business, is in the Officers' Training Camp at Plattsburg.

REPORT STATE SAVINGS BANKS

That the savings banks in the State of New York, now numbering 141, have enjoyed a season of prosperity is shown in the reports filed with the State Superintendent showing their condition from July 1, 1916, to July 1, 1917.

The figures submitted to the New York State Banking Department show that the savings banks' resources on July 1 last totaled \$2,172,916,413.91 as compared with total resources of \$2,053,171,981.23 on July 1, 1916, a gain for the period of \$119,744,432.68.

The amount due depositors on July 1, 1916, was \$1,883,242,203.58, while on

Converting Deposits Into Reserve

is the present day test of your ability to turn a losing account into one of profit.

The best collection system is the one that converts out-of-town checks into available cash in the shortest time.

The transit department of this bank receives and despatches mail 24 hours each day.

Send for our booklet

**“The Transfer of Reserves
To Federal Reserve Banks”**

THE

Philadelphia National Bank

(ORGANIZED 1863)

July 1, 1917, it totaled \$1,991,469,-146.62, an increase for the year of \$108,226,943.04.

During the year ending June 30, 1916, there was deposited with the savings banks, not including dividends credited for that period, \$448,017,922.02, while during the year ending June 30, 1917, a total of \$503,048,944.15 was deposited, showing an increase for the latter period of \$55,031,022.13. During the year ending June 30, 1916, the amount withdrawn amounted to \$422,895,728.29, while during the year ending June 30, 1917, the amount withdrawn totaled \$465,850,758.11, an increase of \$42,955,029.82.

During this period savings banks increased their surplus on estimated market value of stocks and bonds from \$168,986,926.06 to \$179,274,939.62, or \$10,288,013.56. The surplus on par value of stocks and bonds increased from \$189,194,044.78 to \$201,619,592.25, a gain of \$12,425,547.47.

On July 1, 1916, the number of open accounts in the savings banks was

3,335,538, while on July 1 of this year there were 3,452,111 such accounts, an increase of 116,573. During the former period 587,140 accounts were opened or reopened, while during the latter period the total of these accounts was 638,477, a gain of 51,337.

Dividends credited and paid during the year ending June 30, 1916, amounted to \$66,610,020.14, while during the year ending June 30, 1917, they aggregated \$71,022,361.29, an increase of \$4,412,341.15.

BOOKLET ON TRADE ACCEPTANCES

For the purpose of widely disseminating information about trade acceptances and to promote their general adoption, Robert H. Treman, Deputy Governor of the Federal Reserve Bank of New York, has published a booklet entitled “Trade Acceptances.” The booklet deals with this form of commercial paper, in an exhaustive and comprehensive manner, but so lucidly that anyone can readily understand the subject.



ESTABLISHED 1865

PEIRCE SCHOOL

OF BUSINESS ADMINISTRATION

Pine Street, West of Broad

PHILADELPHIA

A Business Course, including banking, accounting, business management, commercial law and other practical subjects, which forms an admirable substitute for a college education and saves from two to three years of time.

Special Courses in banking and business administration for students who have had one or more years in college.

Secretarial Courses for those desiring to prepare themselves for secretarial work.

The school is known throughout the United States for the excellence and thoroughness of its business training. Its graduating classes have been addressed by ex-Presidents Taft, Roosevelt, Harrison and Cleveland.

One of the best school buildings in the country; large gymnasium.

Students may enter at any time during the school year.

Fifty-second Catalogue and Illustrated Booklet will be mailed upon application.

The booklet sets forth how the use of trade acceptances will do more to increase American financial efficiency than almost any other element. The practice will reduce costs and inaugurate economies, and thus lessen the expense of conducting business. It will decrease business losses and commercial failures; enable the seller of merchandise to make a quick turn-over of his capital; secure an early profit, and make his capital available for increasing his business. The use of trade acceptances will also reduce the losses of interest and the losses from bad debts. It will permit a more economical distribution of merchandise and food products, through obtaining low rates of interest, as trade acceptances can be rediscounted at a lower rate than any other form of mercantile paper.

FLORENCE SPENCER APPOINTED ASSISTANT CHIEF CLERK

Miss Florence Spencer has been appointed assistant chief clerk of the Na-

tional City Bank of New York in charge of the women employees of the bank.

"Number Eight" describes her career as follows:

"Born in Marion, Ind., Miss Spencer's parents moved to Chicago, Ill., when she was a little girl. After graduating from preparatory school, Miss Spencer attended the University of Chicago and there specialized in French, English and Sociology. Later she decided to fit herself for the work of librarian and took a course at the University of Wisconsin. For two years she was assistant librarian in the Armour Institute of Technology where she had at one time been a student. In 1906, on the occasion of what was to be but a brief visit to New York City, Miss Spencer decided to locate here. After considering various opportunities she decided to cast her lot with the National City Bank, and accepted the position of librarian for the bank, created by and offered to her by President Vanderlip. In this capacity Miss Spencer



EQUIPPED FOR SERVICE

Located in a modern building with every facility for the efficient handling of its business, this bank is in a position to offer you prompt and adequate service in your Philadelphia banking transactions.

**UNION
NATIONAL
BANK**



PHILADELPHIA

Resources over
\$13,000,000



MISS FLORENCE SPENCER

Assistant Chief Clerk, National City Bank, New York

served for a period of nearly eleven years. During that time she built up the bank's library from a mere collection of business files to a highly special-

ized financial library. In addition to this, Miss Spencer has given valuable service in connection with the organization of the women employees. The organization committee formed in October, 1916, elected her chairman, in which capacity she served until that committee completed its work, and a more permanent form of organization was adopted. On April 1, 1917, Mr. Vanderlip appointed her executive secretary of women, and on July 1, 1917, it became necessary for her to resign from her position as the bank's librarian in order to devote her entire time to her new work."

TO PAY INTEREST ON RECEIVER'S CERTIFICATES

Andrew E. Kalbach, receiver of the Second Avenue Railroad Company, announces that he is authorized to pay the interest on \$3,140,000 outstanding receiver's certificates of that company, at the rate of six per cent. per annum, for the six months period ending October 1,



A NEW CONCRETE FOR BANK VAULTS

PRACTICALLY

FIRE, WATER AND BURGLAR PROOF

VAULTS INSTALLED AND UNDER CONTRACT

Federal Reserve Bank	- - - -	New York City
Guaranty Trust Company	- - - -	"
Metropolitan Life Insurance Company	- - - -	"
Sixty Liberty Street Corporation	- - - -	"
Rhode Island Hospital Trust Company		Providence, R. I.

BY THE

HYDROLITHIC WATERPROOFING CO., Inc.

1328 Broadway

NEW YORK CITY

1917. This interest will be payable at the office of the Guaranty Trust Company of New York, 140 Broadway, New York City, upon presentation of such certificates for appropriate endorsement.

The receiver is also authorized to issue new certificates to such holders of the old certificates as desire to receive the new ones in exchange. Such new certificates will be dated October 1, 1917, and will be due October 1, 1918, but will be redeemable at the option of the receiver on April 1, 1918, at par and accrued interest. It is provided that if the receiver finds it advisable, these certificates shall bear interest coupons and the terms of the certificates shall be properly modified so as to refer to such coupons. Exchange may be effected at the office of the Guaranty Trust Company on and after October 1, 1917.

CHANGES IN BUFFALO BANK

It is announced that J. Alfred Edwards and Leslie P. McDougal have

been elected assistant cashiers of the Market Bank of Buffalo. The board of directors deemed this action necessary owing to the rapid increase in the bank's business.

BANK OF BUFFALO HAS NEW HOME

On September 17, 1917, the Bank of Buffalo opened its doors for business in its new home at Main and North Division streets, Buffalo. Preceding the opening three days were devoted to the clients that they might call and inspect the fine new quarters. One of the bank's new facilities is an added number of tellers, each one having the duty of paying checks and receiving deposits from a certain number of customers. Regarding this change the bank says in the letter announcing the opening in its new quarters:

"A customer is not compelled to stand in line at a receiving teller's window and then stand in line again at a paying teller's window.

"Each teller will become better acquainted with his own customers and

will be allowed more freedom in the use of his judgment. Our business has grown so heavy that, under the old system our tellers were in danger of becoming merely routine men. Under the new system, each teller will feel a closer personal interest in, and touch with, his own customers, and each customer will feel as much at home as if he were doing business with a small separate bank. We hope that this system will not only please our customers but that it will develop our tellers."

COMMENTS ON GENERAL CONDITION OF BUSINESS

In a recent business and financial letter the First National Bank of Philadelphia says:

"Uncertainty over the effects of the Government's price fixing campaign, and inability of business men to tell what proportion of their profits the federal authorities will take in war taxes, have been the controlling factors making for uneasiness in business affairs. This unsettlement has been increased, sentimentally at least, by the utterances of the radical senators at Washington who apparently desire to seize, under the guise of war taxes, about nine-tenths of the profits cleared last year by the great industrial corporations."

COMMENTS ON GOVERNMENT LUMBER PURCHASES

Regarding the large purchases of lumber by the government, the Corn Exchange National Bank of Philadelphia in "The Advance," which is its monthly organ, says:

Since the war began and our government has become a large purchaser, the business has been put on a very sound basis, and while the general public feel that the mill men and lumber men are getting very high prices, still statistics will show that the prices of to-day are only reasonable and with the large increased cost of production merely bring fair returns for the investments.

The government has been very fair towards the mill men. All they want to know is that the lumberman can do his part and the government will deal with its cards on the table.

REPORTS CONDITIONS IN PITTSBURGH DISTRICT

In reporting local business conditions in the Pittsburgh district, the Peoples National Bank of Pittsburgh in its Sep-

America At War



The nation's one great business today is war.

We must all speak, act and serve together for victory.

Our national aims and ideals must by all be known, that all may act as one.

The Bankers of America are spreading this information—and profitably. A definite plan of action is available through



**COLLINS
PUBLICITY
SERVICE**

Philadelphia, Penna.

tember business and financial letter says:

The most important change directly affecting the Pittsburgh district was the announcement of prices fixed by the government for bituminous coal f. o. b. at mines. These prices range from \$1.90 a ton in Alabama to \$3.25 in Washington, a rate of \$2 applying to Pennsylvania and several other large producing fields. This is a reduction of \$1 a ton on the price tentatively agreed upon in July at a conference between representatives of the government and of leading producers in the chief producing states, and the ruling became effective at once. It was announced, however, that subsequent rulings would be made to meet developments in the trade as they arose. A few days preceding the announcement of this price-fixing policy peremptory orders had been issued to forty-six railroads to give preference over other traffic to shipments of coal to the Northwest via the Great Lakes.

AN IMPORTANT MERGER

The consolidation of the Safe Deposit and Trust Company and the Peoples Savings Bank, both of Pittsburgh, to be known after September 29 as the Peoples Savings and Trust Company



A MODERN SAVINGS BANK BUILDING RECENTLY COMPLETED
AT HARRISON AVE. AND DUDLEY ST., BOSTON. FOR THE ELIOT SAVINGS BANK

THOMAS M. JAMES
ARCHITECT

185 DEVONSHIRE STREET.

BOSTON, MASS

of Pittsburgh, marks an important event in Pittsburgh financial circles.

Both institutions have enjoyed continuous existence for over fifty years, the Safe Deposit and Trust Company being the oldest trust company in Pittsburgh. For many years the two institutions have been closely affiliated, the stock of the Peoples Savings Bank being owned entirely by the Safe Deposit and Trust Company with the exception of qualifying directors' shares. Both institutions have long been officered and directed by practically the same men, and have occupied the same quarters. The merger is simply in keeping with the progressive spirit which has long characterized the institutions, and is marked by little or no change in the personnel of the officers and directors.

The old institutions were among the leaders in their respective fields at the time of consolidation, and the new institution begins business with assets over \$22,000,000 and trust funds \$39,000,000, together with the accumulated

good will and prestige of half a century. In view of the consolidation, extensive improvements have been made in the banking quarters at the corner of Fourth avenue and Wood street, which are now numbered among the most handsomely appointed in the country. The capital and surplus of the new institutions is \$9,000,000

Mr. A. C. Robinson, the president of the Safe Deposit and Trust Company, will act in a similar capacity for the new company. Mr. D. McK. Lloyd, who was president of the Peoples Savings Bank for over twenty-seven years, will continue with the new institution as a vice-president. Mr. J. O. Miller, secretary and treasurer of the Safe Deposit and Trust Company, will also be a vice-president of the new company.

**PROMOTION IN OLD COLONY TRUST
COMPANY**

Charles W. Stevens, president Boston chapter the American Institute of Banking, has just been made an

The National Stock Yards National Bank

AND

The National Cattle Loan Company

ST. LOUIS NATIONAL STOCK YARDS, ILLS.

Are the largest cattle financing institution in the Eighth Federal Reserve District

WIRT WRIGHT
President

O. J. SULLIVAN
Vice-President

ROBERT D. GARVIN
Cashier

assistant cashier of the Old Colony Trust Company of Boston. Mr. Stevens has been in the banking business for sixteen years and entered the employ of the Old Colony in 1907, where for the last four years he has been coupon teller. Mr. Stevens has served as a member of the board of governors and for several years as secretary and treasurer of the Boston chapter of the A. I. B. His promotion at this time will be welcome news to members of the Institute all over the United States, as Mr. Stevens is well known and has been a regular attendant at conventions.

BANK MEN RECEIVE MILITARY COMMISSIONS

A number of men who were connected with the National Shawmut Bank of Boston and who joined the Officers' Training Camps have received commissions in the army. Following is the list:

Majors: Benjamin Joy, formerly vice-president, cashier and director, and Robert Homans, director; Captains: T. Jefferson Coolidge, 3rd, George L. Aspinwall and A. B. Onthank; Second Lieutenants: Robert S. Potter, formerly assistant cashier, and A. W. Chisholm.

OPENS BUENOS AIRES BRANCH

Recently the First National Bank of Boston commenced business in the new branch office in Buenos Aires, Argentina, which is located at the corner of San Martin and Bartolomé Mitre. At the close of the first four days' business, the management reports that 225 ac-

counts had been opened, total deposits exceeding \$4,000,000. Noel F. Tribe is the manager.

BANK REPORTS ON COTTON TRADE

Commenting on the cotton situation, the First National Bank of Boston, in its September business and financial review, says:

"An important matter in the outlook for the new cotton year, beginning this month, is the probability of lessened exports due to scarcity of ships. Mercantile opinion of the crop prospects at this time, which is formed from reports emanating from southern manufacturers and southern distributors of goods, inclines to the belief that the crop will yield well over 12,500,000 bales, with average conditions obtaining till the first frost. The basis of this opinion is the good fructage of a sturdy though small plant, and the maintained inducement of a very high price to encourage rapid picking. The movement of the crop will be delayed at home by railroad congestion. Whether these conditions can bring about lower price levels before January will depend largely upon the measure of financial assistance required in the early months of the movement.

"Production has been restricted still more by excessive heat and the desire of operatives for summer vacations. The scarcity of labor is being felt more than in normal years in southern centres in consequence of adjustment to conditions imposed by the National Child Labor Act. Thus far the profits of mills are not being cut out by the labor developments, but manufacturers are urging selling agents to check any tendency to very late contracts until it is clear what winter wage and working conditions will be. A majority opinion prevails among merchants that as many goods as mills can make for the rest of the year will be wanted at profitable prices and the immediate conditions in jobbing distribution are favorable."

OSBORNE OF MERCHANTS NATIONAL JOINS ARMY

From vice-president of one of Boston's largest banks to an ordinary private in the First Heavy Maine Artillery is the latest move in the career of David M. Osborne of Boston and Manchester-by-the-Sea, son of Thomas

Mott Osborne, famous Sing Sing reform warden.

Osborne has resigned his position as vice-president of the Merchants' National Bank at a large salary, to serve his country at a salary of \$30 a month.

IMPROVEMENTS AT PROVIDENCE
NATIONAL BANK

Extensive improvements have been made in the quarters of the Providence National Bank, Providence, R. I., consisting of new officers' space and a new directors' room. The improvements are carried out in Colonial style, in keeping with the fine old building the bank has occupied since 1801.

RICHMOND CHAMBER OF COMMERCE
HOLDS JUBILEE

Richmond's foremost business organization, the Richmond, (Va.) Chamber of Commerce, recently celebrated its fiftieth anniversary at a meeting at the

**BANKS ORGANIZED, FINANCED,
BOUGHT AND SOLD,** everywhere; ample funds always on hand for good new, or old dividend paying bank stocks, carrying official positions. Highest class, confidential selling and buying service rendered banks, bankers and investors. JOHN P. JONES, Monadnock Block, Chicago, Ill.

Jefferson Hotel. About 400 men representing nearly all of the city's commercial and industrial organizations were present. When the Richmond Chamber of Commerce was formed in 1867 the South and Virginia were all in the throes of poverty and depression. The present situation is best described by one of the local papers:

Fifty years ago Richmond, with a population of less than 50,000 souls, was slowly recovering from the final woes of the surrender at Appomattox Courthouse and new buildings were slowly taking the place of those burned during the evacuation. Records show that at that time the property valuation was less than \$18,000,000, as compared with \$125,000,000. Capital and surplus of Richmond banks at the close of the war was \$1,000,000, and to-day it is nearer \$25,000,000. Richmond's city directory of 1886 contained 170 pages, while the 1917 book has nearly 2,000. The recovery from the \$30,000,000 fire during the evacuation was slow, but in recent years construction has been greatly increased. The fire, however, wrought little or no change in the financial section, which continues on East Main Street, near the postoffice.

STATEMENT RICHMOND FEDERAL
RESERVE BANK

With rediscounts of the Federal Reserve Bank of Richmond reaching the enormous amount of \$19,681,000 for the week ending September 15, a new high mark was established by the local federal institution. The previous high figures were made for the week ending July 21, when securities amounting to \$11,151,000 were handled in the six days. The heavy activities of the week were due to the calling in of Liberty Loan deposits throughout the district.

BREAKS RECORD FOR CLEARINGS

With clearings amounting to \$7,408,089, on September 11, all daily records of the Richmond Clearing House Association, Richmond (Va.), were broken, while the total clearings for the month ending September 19, inclusive, amounted to \$78,582,375, being \$32,468,649 in

We are the Largest Manufacturers of
**Home Safes and Pocket
Savings Banks** IN THE
WORLD



Standard Oval Pocket

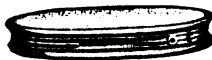

Simplex Round



Gem Home Safe

Low in Price
High in Quality

Our Banks are endorsed by over 3,000 of the leading Banking Institutions of the United States. Write us for

FREE SAMPLES

Catalogue, illustrating our eleven different types, endorsements and plans of distribution.

NOTE:—The Standard Oval Pocket Bank holds quarters and smaller coins.

The Simplex Round Bank holds dimes. Can also be made to hold quarters and smaller coins.

The Gem Home Safe holds half dollars and smaller coins; also currency.

STRONGHART COMPANY
1510-12-14-1516 S. WABASH AVE.
CHICAGO, U. S. A.

SEND YOUR BUSINESS

ON THE

Twin Cities AND THE Northwest

TO THE

**CAPITAL AND SURPLUS
TEN MILLION DOLLARS**



We are prepared to meet your most exacting requirements and cordially invite you to write to us

excess of the corresponding dates last year.

**RICHMOND MAN ON EXECUTIVE COUNCIL,
A. I. B.**

W. A. Roper, assistant cashier of the Bank of Commerce and Trust, has been elected a member of the National Executive Council of the American Institute of Banking. Mr. Roper is the retired president of the Richmond Chapter, American Institute of Banking, and is active in financial circles. He is the second Richmonder who has been honored with a place in the council, the other member being George H. Keesee, cashier of the Federal Reserve Bank of Richmond.

The local chapter has a membership of over 300 and is doing an excellent work among the young bankers of the city. L. B. Thomas of the Merchants National Bank is president of the chapter.

CLINTON G. MORGAN PROMOTED

The National Exchange Bank of Baltimore announces the following changes. Clinton G. Morgan has been appointed cashier and William R. Webb assistant cashier.

**ACTING CHIEF NATIONAL BANK
EXAMINER**

The Comptroller of the Currency announces that Elmore F. Higgins, of Alabama, assistant chief national bank examiner at Chicago, has been appointed acting chief national bank examiner for

the Fifth Federal Reserve District, with headquarters at Richmond, succeeding temporarily the late Thomas P. Howard, chief national bank examiner, who was killed in an automobile accident.

UNION TRUST COMPANY OF CHICAGO

Two important announcements were recently made by this institution—mem-

**The ^{B/L}
Collection Bank
of Chicago**



We have a special proposition for any bank or corporation handling bill of lading drafts on Chicago and Eastern points.

**UNION TRUST COMPANY
Chicago**

*Strictly a Commercial Bank
Member of the Federal Reserve System
Established 1869*



At the Gateway to the Great Southwest

The National Bank of Commerce

IN ST. LOUIS

offers its services for the prompt and dependable handling of your banking business in this section of the country

Capital, Surplus and Profits, over \$13,000,000.00

*“Large enough to serve any—
Strong enough to protect all”*

TOM RANDOLPH, Chairman of the Board

JOHN G. LONSDALE, President

W. B. COWEN, Vice-President

W. L. McDONALD, Vice-President

J. A. LEWIS, Vice-President and Cashier

bership in the Federal Reserve System, and the doubling of the floor space occupied.

The reserve power of the company, which was already very large, is further increased by joining the Federal Reserve System and the ability to serve depositors materially enlarged. Additional space was provided to more fully meet the present demands and the growth in the company's business.

CHICAGO BANK COMMENTS ON PRICE FIXING

The National Bank of the Republic of Chicago, in its September business and financial letter, comments on trade conditions as follows:

Just now the stimulation of industry to larger production in order to meet the needs of our fighting forces is far more vital than the question of price. A possible effect of price regulation may be inferred from the misgivings in the soft coal trade following the recent announcement of the maximum prices which shall obtain at the mines. It is claimed that in a great many small mines operations will have to be suspended because of inability to produce the coal at the prices named unless wages and the cost of supplies are re-

duced accordingly. Although lower coal prices are to be welcomed by the public and the manufacturing interests of the country, most of the railroads and large manufacturing corporations, which already have long term contracts for coal, will not be immediately affected by the executive order which applies only to new business. In view of this fact, it is claimed by some operators that there will be little incentive to produce beyond what is needed to fulfill their contract obligations, especially as their labor supply, already inadequate, is being further reduced through the operation of the military draft law.

BANK WRITES TO LIVE STOCK BREEDERS

The National Stock Yards National Bank of National Stock Yards, Illinois, has sent a letter to live stock breeders, feeders, and financiers, urging the breeding of herds and utilization of crops. The letter says:

Our farmers will probably produce this year the greatest crops of feeding grains and roughage of our history.

Patriotism, which means efficient prosecution of the war, and our best economic interests lead us to the same conclusions.

First, the farmers and live stock men of this country must maintain and increase their breeding herds for the profitable period after the war.

Second, the feed crops raised this year must be further utilized in the finishing of animals fit for slaughter.

These two plans present the surest means of profitably marketing feed crops in the face of their probable large yield and possible railroad congestion.



DEVELOPING
MAN-POWER
IN
BANKING



Some men, like machines, are replacable at cost, or less. Others are indispensable as the power which propels the modern super-dreadnought.

Modern banking needs these *power* men, men who can solve intelligently the intricate banking problems of today, who can create and develop new business, and who are capable of forming sound banking judgments. And there is a way of developing executive bankers, for the complex problems of present-day banking.

The New La Salle Course in Banking and Finance

offers for the first time, practical and fundamental training in banking—not merely for clerical work, but for the real brain work of modern banking. It makes a concrete appeal to bank officers, directors, cashiers, and bank employees, who have a spirit for the better things in banking.

A Few of the Noted Authorities in Banking and Finance Who Have Made this Course Possible

- | | |
|---|---|
| <p>Elmer H. Youngman, Editor, The Bankers Magazine, New York City
H. Parker Willis, Ph. D., Secretary, Federal Reserve Board, Washington.
George E. Roberts, National City Bank, New York City.
Arthur B. Hall, A. B., Real Estate Expert, Chicago.
Louis Guenther, Editor, Financial World, New York City.
Frederick Vierling, Trust Officer, Mississippi Valley Trust Company, St. Louis.
Edward M. Skinner, General Manager, Wilson Brothers, Chicago.
William Bethke, M. A., Director, Department of Business Administration, La Salle Extension University.
Samuel D. Hirschl, S. B., J. D., Member Illinois Bar, Chicago.
Frederick Thulin, LL. B., Formerly of the Union Trust Company, Chicago.</p> | <p>O. Howard Wolfe, Cashier, Philadelphia National Bank, Philadelphia.
Walter D. Moody, Managing Director, Chicago Plan Commission.
R. S. White, Collection Manager, American Steel and Wire Company.
C. M. Cartwright, Managing Editor Western Underwriter, Chicago.
Warren F. Hickernell, A. B., Former Editor Brookmire Economic Service.
Irving E. Allen, Sales and Advertising Counselor, Chicago.</p> |
|---|---|

60-Page Book "Banking and Finance" FREE upon Request

This publication will be mailed free and post-paid to any bank officer or individual interested. It contains useful information on modern banking questions and shows clearly what this course can do for the individual or for a bank. You owe it to yourself and your business to know about this work. Write for your copy today.

Address

LaSALLE EXTENSION UNIVERSITY

"The World's Greatest Extension University"

Dept. 4312-D

Chicago, Illinois



Accurate News of Pacific Northwest

Have You Business or Investment Interests in Washington, Oregon, Montana, Idaho, Alaska or British Columbia?

The authoritative commercial and financial publication of this section is BUSINESS CHRONICLE OF THE PACIFIC NORTHWEST issued every Saturday Morning. It tells what you need to know of banking, investments, lumber, fish, apples, agricultural products, mining, foreign trade, railway and marine transportation, commercial and business affairs generally, and analyzes current progress and development. You may rely upon what you see in its columns.

Send for free sample copy. There is no paper like it anywhere.

BUSINESS CHRONICLE

EDWIN SELVIN, Editor

Alaska Building SEATTLE, U. S. A.

President, E. S. Hecht, vice-president Hibernia Bank and Trust Company, New Orleans, La.; vice-president, J. C. Thompson, auditor Northwestern National Bank, Minneapolis, Minn. Members of executive council for three years, Clarence A. Rathbone, Boston, Mass.; Wilfred A. Roper, Richmond, Va.; Joseph A. Seaborg, New York City, N. Y., and Frank J. Maurice, Detroit, Mich.

ST. LOUIS BANK ENLARGES QUARTERS

It is announced that work will soon begin on the present quarters of the National Bank of Commerce of St. Louis in remodeling the building formerly occupied by the Post-Dispatch and a connection made on each floor of the three buildings owned by the bank on Broadway from Olive to Pine Streets. The enlarging is the result of the continual growth in the volume of business transacted and the promise of still further increase with the extension of the bank's field of operation.

F. O. WATTS ADDRESSES BUSINESS MEN'S CONVENTION

F. O. Watts, president of the Third National Bank of St. Louis, addressed the Business Men's Convention at Atlantic City on September 22 on the subject of war taxation. The bank was represented by F. O. Watts, president; R. S. Hawes and F. K. Houston, vice-presidents.

ISSUES BOOKLET ON CROP REPORTS

The Continental and Commercial National Bank of Chicago has issued the crop report and general business condition booklet for 1917. It is an excellent review, presenting in a concise form a resumé as seen by leading business men and bankers throughout the country. There are many large and extensive tables but the following table giving the estimated crop yield is of interest:

Crop	1917 Bushels	1916 Bushels
Wheat	660,000,000	640,000,000
Corn	3,200,000,000	2,583,000,000
Oats	1,527,000,000	1,251,000,000
Barley	208,000,000	181,000,000
Rye	57,000,000	47,000,000
All cereals	5,652,000,000	4,702,000,000
Potatoes	493,000,000	285,000,000
Hay (tame) tons	82,000,000	90,000,000
Cotton, bales...	11,000,000	11,400,000

CONVENTION OF AMERICAN INSTITUTE OF BANKING

The Fifteenth Annual Convention of the American Institute of Banking was held at the Hotel LaSalle, Chicago, September 12, 1917. The convention was presided over by President E. G. McWilliam of the Guaranty Trust Company of New York.

Owing to war conditions the convention was limited to a single business session of one day. At the opening of the convention the entire body rose in tribute to the members who are enlisted in the service of our country.

The following officers were elected:

Autumn at the Shore

A few days or a week at the shore will work wonders with the busy man or woman who find it impossible to take an extended vacation.

THE ST. CHARLES

offers every possible inducement to those seeking rest and relaxation. Write for booklet and terms.

NEWLIN HAINES CO.
ATLANTIC CITY - - - N. J.

St. Louis and the Mississippi Valley

Through our membership in the Federal Reserve System and the St. Louis Clearing House Association, complete facilities are offered Banks and Trust Companies for handling their business in St. Louis and throughout the entire Mississippi Valley, upon most favorable terms.

Correspondence
invited



**Mississippi Valley
Trust Co.**
SAINT LOUIS

GOES WITH MISSISSIPPI VALLEY TRUST CO.

Leo Osthaus, Jr., formerly representative for the Guaranty Trust Company of New York in Southern Illinois and Missouri, has accepted a position with the Mississippi Valley Trust Company, St. Louis, in the sales organization of the bond department.

CONDITIONS IN AND ABOUT ST. LOUIS BY
JOHN G. LONSDALE, PRESIDENT THE
NATIONAL BANK OF COMMERCE,
IN ST. LOUIS

In analyzing St. Louis conditions in the Autumn, we realize that this is the beginning of the business year, and therefore at this time we are in a position to gauge conditions and plan accordingly.

The cotton crop and its products alone at prevailing prices will aggregate an amount greater than the first Liberty Loan, more than two billion

dollars, while through the campaign of diversified crops launched by bankers, and exemplified by the farmers, cotton will prove to be largely a surplus money crop, and will add great wealth to the country known as the cotton belt, for which we are bankers. The grain crops, too, are abundant—wheat, oats and corn—and the stabilization of the prices of these products assures a greater purchasing power to the farmer.

The lumber industry has enjoyed unusual prosperity and prices are very satisfactory. This has added to the great distribution of money all over our section of the country.

As to the stock and cattle business, while the prevailing high prices have been tempting and have caused the sale of breeding stock, we have preached and are still preaching conservation of this asset, the great value of which cannot yet be reckoned.

Established
1857



60 Years of Con-
servative Banking

The
**Mechanics-American
National Bank**
of St. Louis

Capital, \$2,000,000

Surplus, \$2,500,000

Resources, \$39,233,000

A STRONG BANK WITH THE EQUIPMENT, THE EXPERIENCE AND
THE STRENGTH TO GIVE THE BEST SERVICE

ACCOUNTS INVITED

WALKER HILL, President

FRANK O. HICKS . . . Vice-President	JOSEPH S. CALFEE Cashier
JACKSON JOHNSON . . Vice-President	CHARLES L. ALLEN . . . Asst. Cashier
EPHRON CATLIN . . . Vice-President	JAMES R. LEAVELL . . . Asst. Cashier
WILLIAM H. HETTEL . . Asst. Cashier	

The manufacturing industry in St. Louis is having its inning, and we are supplying the needs not only of our own country, but of foreign countries as well.

Pending the movement and activities of these crops and industries, money is in good demand, the rates prevailing the same as in New York and Chicago, so in summing up, I should say of conditions in St. Louis that we show the balance on the right side of the ledger.

CROP CONDITIONS IN NORTHWEST

Regarding crop conditions in the Northwest, the Northwestern National Bank of Minneapolis, in its September business and financial letter, says:

The crops in Montana will be better than was expected last month. Conditions are so uneven that estimates are difficult, if not impossible. In some places they run from no crop of wheat at all, to 18 bushels. The northern sections have been, perhaps, the least favored, though some areas will do fairly well. There may be an average for the state of one-third of a normal crop. Serving somewhat to balance things, there was a large increase in the 1917 wheat acreage; also, the usual yield

per acre for this state runs two or three times larger than that reached in Minnesota, North Dakota and South Dakota, so that "one-third of a normal crop" means more here than farther east. Also, the quality of grain is very good.

The crops in the remaining part of this reserve district run more evenly than Montana and North Dakota. In northern South Dakota the wheat yield will probably be about 12 bushels to the acre, though this estimate is quite too high for the Northwest. In the north central and northeastern parts of the state, oats will run about 35 to 40 bushels and barley 25 to 30 bushels. In the east central part, barley and oats are generally excellent, corn backward and with prospects of but a fair crop, wheat yielding all the way from 7 to 20 bushels. The southern Rosebud country is getting the best crop it has ever harvested—wheat 25 bushels, oats 50, and barley about 65.

TELLS EMPLOYEES HOW TO HELP WIN WAR

The Fidelity Trust Company of Kansas City, Missouri, in "The Fidelity Spirit," which is the publication of the bank, contains the following good hints on how to help to win the war:

Do not think that your part in helping to win the war is so small that it is of no use. There is no service, however small it may seem, that will not help.

Save the wheat. Eat one wheatless meal every day. Use corn, oatmeal, rye or barley bread. Put the loaf on the table and cut it only as needed. If you use baker's bread order it in advance so that you will be doing



Mink Lining With Alaska Seal Collar

MEN'S FUR AND FUR LINED COATS

\$25.00 to \$500.00

CLOTH COATS WITH FUR COLLARS

\$25.00 to \$90.00

C. C. Shayne & Co.

Manufacturers of

Strictly Reliable Furs

126 West 42d Street, New York

\$1,100,000
SAVED
 IN HANDLING
2,750,000,000

POSTAGE STAMPS *through*



SEALS · STAMPS AND COUNTS
 250 ENVELOPES PER MINUTE

80% CHEAPER
 than by any
 other method

**MAN
 POWER
 SAVED**

Let Us Show YOU How To Save Money

MAIL-O-METER
 SALES COMPANY
 CHICAGO

MAIL-O-METER
 COMPANY
 DETROIT

MAIL-O-METER
 SALES COMPANY
 NEW YORK

your part in stopping waste by aiding the baker to make no more than his customers need. Save on the meat. You will help yourself by so doing, for this will have a tendency to reduce the price. The supply and demand law still lives, remember. There is plenty of demand and will be, for all the meat America can produce. Help conserve the supply. Don't waste the fats. Save in every possible way. In the use of every possible foodstuff. If every one in America will save one ounce of sugar daily, it will mean a saving of 1,100,000 tons for the year. All these savings will affect the price, remember, and price is an item of interest these days.

Remember the French and English, the Italians and the other nations right next door to war. Consider our fortunate location in that respect, far from the ravages of war, our beautiful land as yet unscathed. Remember this and decide to help feed those nations over there

fighting the battles of democracy. Remember—and help, no matter how small your part!

**KANSAS CITY MEN WIN CITY BANK
 SCHOLARSHIP**

The annual scholarship given to the American Institute of Banking by the National City Bank of New York was awarded this year to E. B. Bradbury and J. B. McCarter, both from Kansas City chapter, and both from the Commercial National Bank of Kansas City, Kansas.

Elmer B. Bradbury, recently elected secretary of Kansas City chapter, has been with the Commercial National for nine years, during which time he has worked in every department of the bank and at present is manager of their transit department.

J. Brack McCarter has been working in the Commercial National for ten years, during which time he has been in nearly every department, and at present holds the position of auditor.

Needless to say, both of these men are graduates of the Institute and they have been active in the various classes conducted by Kansas City chapter. Both men are also proficient debaters. It is a singular tribute to Kansas City chapter that it should furnish the two men who win the coveted honor of the City Bank Scholarship this year.

REPORTS TRADE WITH FAR EAST

The figures given by the American National Bank of San Francisco, in its financial letter of August 25, 1917, relative to the increase in trade between this country and the Far East, are very interesting. Following is the comparison between 1916 and 1917:

Exports to—	1917	1916
China	\$37,306,388	\$25,131,459
British E. Indies..	37,090,430	24,696,872
Japan	130,472,189	74,470,931
Russia in Asia...	130,300,542	131,111,792
Australia and New Zealand	82,043,469	74,002,526
Philippines	27,545,470	23,421,172
British E. Indies..	37,090,430	24,696,872
Imports from—	1917	1916
China	\$105,905,531	\$71,655,045
British E. Indies..	217,610,056	177,423,346
Japan	208,127,478	147,644,228
Australia and New Zealand	18,874,571	64,553,441
Philippines	42,436,247	28,232,249

CHARTERED BANKS OF CANADA

According to the return of the chartered banks of the Dominion of Canada made to the Minister of Finance, July 31, 1917, the twenty-one listed banks show a total paid-up capital of \$111,647,959 and a reserve fund of \$113,499,203. Public deposits are \$450,849,356, with public deposits in Canada payable after notice \$929,442,340. Deposits elsewhere than in Canada are \$183,846,718. Deposits made by banks in Canada amount to \$8,731,151, while

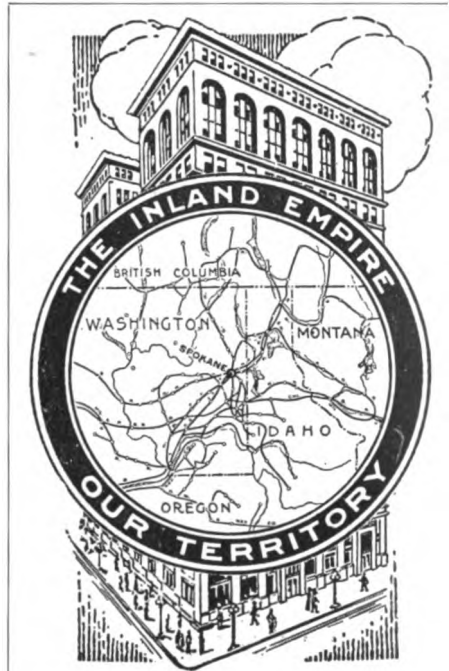

The Old National Bank of Spokane

WITH direct connections in every banking point throughout the "Inland Empire"—a region three times the size of Alabama, of which Spokane is the financial and railroad center—The Old National has the facilities to collect your Pacific Northwest items with exceptional economy and dispatch.

OFFICERS

- D. W. TWOHY, *President*
- T. J. HUMBERD, *Vice-President*
- W. D. VINCENT, *Vice-President*
- J. A. YEOMANS, *Cashier*
- W. J. SMITHSON
- G. H. GREENWOOD J. W. BRADLEY
- Assistant Cashiers*

RESOURCES : \$20,000,000

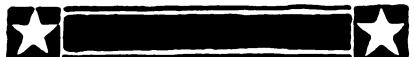

the amount due to banking correspondents elsewhere than Canada and the United Kingdom are \$23,806,270. Total liabilities are \$1,827,273,169, with total assets of \$2,072,686,194. Current loans and discounts in Canada are, not including call and short loans, \$829,560,700, and loans elsewhere than in Canada are \$90,253,882.

MUTUAL BUILDING AND LOAN SOCIETY OF HAWAII

The July 23, 1917, statement of the Mutual Building and Loan Society of Hawaii, Limited, with head offices in Honolulu, shows total resources of \$282,186.04 and a total paid-in capital of \$215,814.95. Total earnings for the year amounted to \$18,664.71, with net earnings of \$14,295.40.



Must Finish What We Have Set Out To Do

By GEORGE L. TICKNER,

Vice-President National Bank of Syracuse, N. Y.

THE war must continue to a satisfactory conclusion, no matter how unsatisfactory our material or financial condition may be. The war is international and is being fought that democracy and freedom may still reign, and what may happen to an individual or business concern is relatively of slight moment since this nation, with its Allies, all fighting to maintain freedom, must stand or fall together. It is better to come out broke with freedom surviving than to come out with all the world's goods and enslaved by the present German autocracy.



Pioneer Financial Institutions

THE first bank in England was established by Francis Child, a London goldsmith, who died Oct. 4, 1713. This pioneer financial institution was

opened in 1663, and a number of rival goldsmiths soon opened similar concerns. The Mint in the Tower of London had been the depository for the cash of the merchants until Charles I seized the money as a loan. Then the traders began to deposit their cash with the goldsmiths in Lombard Street. The first bank in the world was established in Italy in 808 by Lombard Jews. The oldest existing bank is the Bank of Barcelona, Spain, which was founded in 1401. The Bank of England was started in 1694.



Banks Giving Employment to Women in Large Numbers

THE surprising rapidity with which women are being recruited into banks to fill the positions of men made vacant by the draft or voluntary military service, is disclosed by a report given out by the standing committee on employment of the Mayor's Committee of Women on National Defense at 6 East 39th Street.

According to the report 51 banks and trust companies were visited by two volunteer investigators. The investigators said that women have been taken on in these banks in large numbers in the last few weeks; in many instances, they said, employers had anticipated the draft and other inroads on their working force because of the war, and long ago started to train women substitutes. The report said:

"In the National City Bank 325 women are already employed; in the Guaranty Trust Company, 200; the Chase National Bank, 56; Farmers Loan and Trust Company, 76; Bankers Trust Company, 160; National Park Bank, 76; Equitable Trust Company, 100; Corn Exchange Bank, 70, in one department; Brown Bros., 60. The percentage of women to men employed runs as high as one to three or four. In only two of the banks visited investigators were told that women would not be employed under any circumstances."



Open Case

An Easy and Positive Means of Identifying Signatures

THE comparative ease with which anyone's handwriting may be imitated, even by an amateur forger, constitutes one of the great worries of the banking business.

In cases where the paying tellers are familiar with their depositors' signatures, it is not always possible, in the rush of business, to give to every check that careful scrutiny that would enable a clever forgery to be detected, and many imitated signatures are so nearly perfect that only a handwriting expert could detect the difference between them.

But there are thousands of signatures on bank paper about whose genuineness the bank has no present means of

determining. Reference is made to endorsements.

It is not practicable, of course, to verify all signatures to bank paper. This would consume too much time, and in most cases it is unnecessary.

But what is highly desirable, if banks are to be protected against the large losses they now annually incur through forged checks and forged signatures to savings bank deposit receipts, is to have a standard signature to which they can refer with confidence, knowing absolutely that it can not be imitated, much less practically duplicated.

The handwriting of the same person varies under different circumstances. A case is recalled by the present writer



Press the fingers against the Identigraph Stone



Put the card under shield and press the fingers in the three openings



Pull out card, raise working table

who presented a check at a New York bank a few years ago and was refused payment on the ground that the signature did not correspond to that on file. A few minutes later a check from the same drawer was presented again by the same person and promptly paid.

It is possible, as will be explained later, to have on file in the bank an unvarying signature, which if also used on checks would positively avoid cases like that above cited, and would afford the bank an absolutely sure means of verifying all signatures.

The handwriting of some persons changes with their varying moods. A person with an emotional temperament will write differently according as he is elated or depressed, while everybody writes differently as the ink, pens and paper are either good or bad. A temporary nervous condition will also materially vary the handwriting, as will also exposure of the hands to cold shortly before making a signature.

These facts have come within the common observation. Banks have paid

quite dearly, as a rule, to learn what they know about signatures.

But if these difficulties are experienced with regard to written signatures—and the case has been rather understated—what shall be said of the signatures of illiterate people who can only make their mark? There is room for distinguishing traits in handwriting, but certainly very little where only two marks are used in making a cross of some kind.

On account of the ease with which this simple form of signature may be imitated, savings banks have sustained very heavy losses where pass-books have fallen into the hands of persons not entitled to them, but who perhaps from being a relative could answer all questions satisfactorily, and of course were able to imitate this primitive form of signature.

There is only one absolutely dependable form of signature in the case of illiterates. Namely, the use of fingerprint identification, which also has many advantages over written signatures.

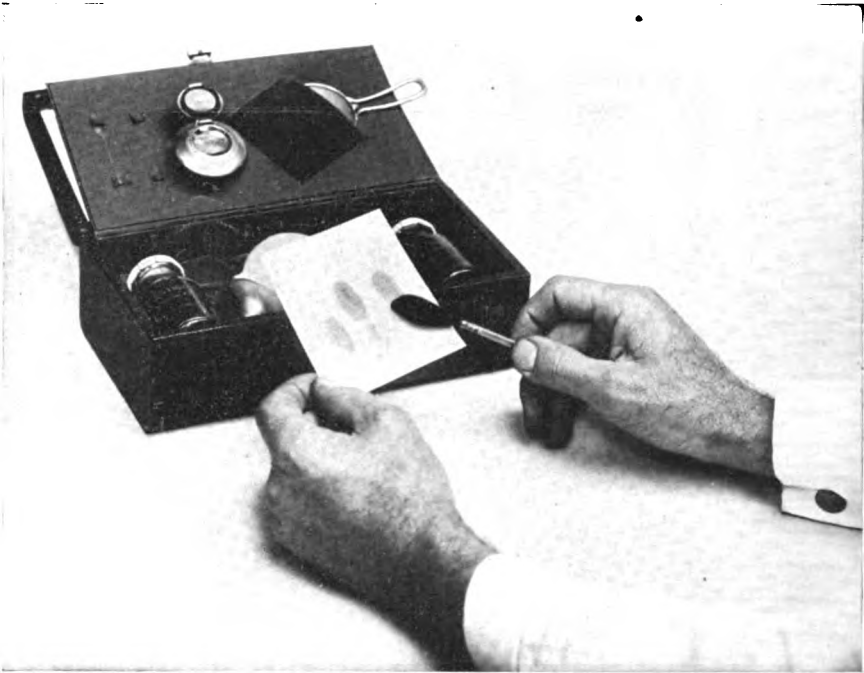

Open metal cup. Dip camels hair brush into it and brush powder in circular motion over the card to develop Identigraph joints

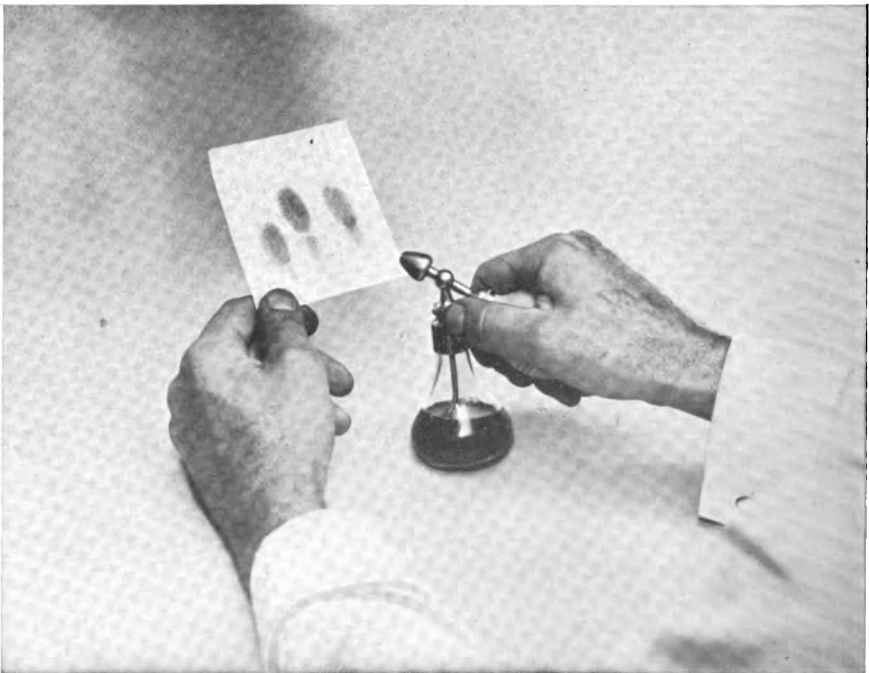

Take atomizer and spray fixing liquid on developed Identigraph to fix and make permanent



The finished Identigraph print ready to file—less than a minute

The value of finger-print identification, particularly in handling the accounts of illiterates, is thus strikingly stated by W. H. Kniffin, Jr., the well-known savings bank authority, in his valuable treatise "The Savings Bank and Its Practical Work."

"It is not a difficult matter to steal a pass-book and by a little skilful maneuvering obtain all the data necessary to pass the usual test; especially is this true of foreigners, who are coming to our shores in ever-increasing numbers, and are rapidly becoming a factor to reckon with in savings bank management. The most dangerous frauds are those perpetrated by members of the same family, when all test questions are easily answered.

"Some banks will not accept the money of illiterates, and in so doing they negative the very purpose of their existence. Were they not designed to care for the money of the masses—those who could not properly care for their own? And if they were created primarily as depositories for the poor and

ignorant it is hardly fair to penalize a man's ignorance by refusing to take his money when he appears with it. And yet, the bank is not called upon to take undue risks, and such it undoubtedly takes when it accepts the money of the man whose identity is hard to establish. These 'Americans in the making' are not always easy to identify. They are clannish, often shrewd and difficult to do business with without an interpreter, and cases are frequent where the book has been stolen by a boarder and the usual tests successfully passed and money obtained without great risk of detection. In one case, in opening an account for another (both Poles), the one depositing wrote his own name instead of that of the owner of the fund, and for five years the bank was dealing with one man having another man's name on his book. When payment was asked, it took a long time to get the matter straightened out. A finger-print test would soon have demonstrated they were different people.

"There is but one sure test of identity,

and that is the finger prints. These are not, as many would suppose, mere smudges of black, but 'steel engravings' wrought on the tips of the fingers by the Almighty, as distinctive as the lathe work on a ten-dollar bill and as lasting as human life. No man ever writes his name exactly twice alike;



JAMES J. MORGAN

President The Identigraph Company, Inc., New York

but he carries a signature on his finger tips that never changes from the cradle to the grave. According to the English expert, Galton, the chances of exact duplication are one in sixty-four billion.

"This is no new discovery, for the Chinese have used them many years, and in police work everywhere finger print identification has long been used as a sure means of identifying criminals. In its adaptation to savings banking, it is, however, a comparatively recent innovation."

As to the ease in reading finger prints, Mr. Kniffin says:

"Tellers working with both finger prints and signatures express a preference for the finger prints as the easiest and quickest read."

Through use of the Identigraph, illustrated above, bankers have an inexpensive and perfectly sure means of avoiding all loss from forged signatures. That is, they have a positive means of establishing the correctness of any signature, thus enabling them to make certain the identification of genuine signatures.

The Identigraph is an extension of the finger-print method, but differing from other uses of this device by completely doing away with ink, using a sensitized plate on which an impression is made without ink or liquid of any kind.

This completely obviates the objection of soiled fingers, which rendered other methods of using finger-prints impracticable.

Furthermore, by using three fingers instead of one, a record of finger-print signatures is obtained that it is impossible to confuse with any other signature, and one which may be easily and quickly verified. In fact, one without any experience whatever in the use of finger-print signatures can in a moment detect a real signature of this kind from any attempt at imitation, the reason being that the difference between the prints of any three fingers is so great as to be instantly recognized even by a novice.

The fact that the Identigraph offers a thoroughly dependable means of verifying signatures, that it is cheap, can be used without soiling the fingers in the least, and that its records can be read instantly and correctly by any intelligent clerk, will commend its use to all banks seeking to safeguard the funds of their depositors in every practicable way, and to conduct the affairs of their institutions with due regard to the more efficient methods.

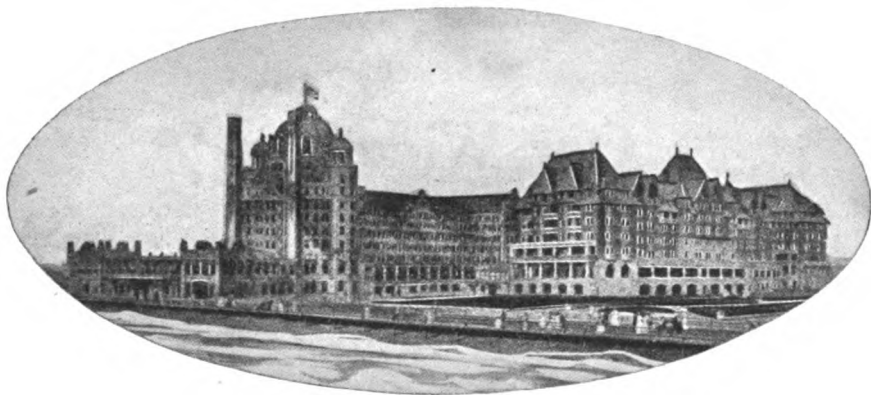

The Marlboro-Blenheim, Convention Headquarters

Forty-Third Annual Convention American Bankers Association

Atlantic City, N. J., September 24-29, 1917

WITHIN sound of the manifold voices of the sea, the cheering thousands who attended the forty-third annual convention of the American Bankers Association at Atlantic City, N. J., September 24 to 29, roared forth their patriotism in tones that rose clear and loud above the angry crashing on the waves on the beach.

It was a dramatic convention, whose unmistakable keynote was patriotism.

The spirit of the bankers—the spirit of America—was voiced by President Nicholas Murray Butler of Columbia University in an address that was scholarly, logical and eloquent, and whose patriotic fervor aroused the great audience of bankers to the highest pitch of enthusiasm. This was not only the distinguishing feature of the convention, but it was probably momentous in the future history of the country, for Presi-

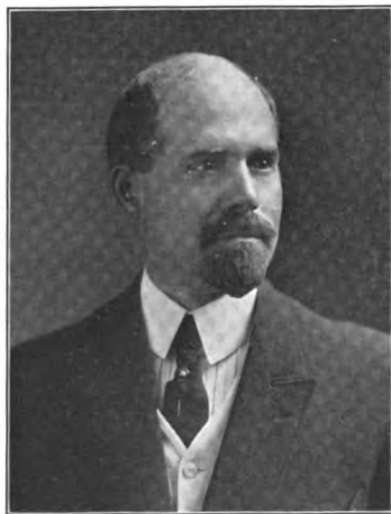

CHARLES A. HINSCH

President American Bankers Association; President Fifth-Third National Bank, Cincinnati

dent Butler in demanding that La Follette be expelled from the United States Senate spoke the sentiments of the

Our Widening Circle

of business friendship is best shown by the following figures, from statements made the comptroller:

DEPOSITS

September 5, 1900	.	\$11,471,000
August 25, 1905	.	15,480,000
September 1, 1910	.	20,505,001
September 4, 1912	.	23,967,000
September 12, 1914	.	25,116,000
September 2, 1915	.	29,639,841
September 12, 1916	.	39,163,000
September 11, 1917	.	42,371,000

There are reciprocal advantages between customers and bank, both of high standing.



CORN EXCHANGE NATIONAL BANK
PHILADELPHIA

CHESTNUT at SECOND

bankers and of every other patriotic American.

But his address had even a higher significance. He pointed out that the war virtually represented the quest of a new world, and that upon this voyage of discovery—fraught with the future civilization of mankind—America was now embarked and to stop short of complete and unconditional victory over those who oppose our course would presage the swift relapse of the world into an unspeakable night of barbarism.

No purpose here exists to paraphrase Dr. Butler's memorable address. It is worthy of complete presentation, and this will be found in succeeding pages. It was beyond all question the great event of the Atlantic City convention, for it fittingly expressed what every banker and every true American feels in this crisis of our national history.

Because it fell to the lot of President Butler to speak for the bankers and for the country, and because he performed his duty with such truth and spirit that no one could possibly surpass his restrained but lofty eloquence, the really great utterances of other speakers shone less conspicuously.

But if anybody asks a banker or anyone else why this country is at war, a complete and irrefutable answer to that question will be found in the carefully-prepared address of Hon. W. G. McAdoo, Secretary of the Treasury. With the clear precision of the most dispassionate historian, Secretary McAdoo traced the course of events which finally led to our entrance into the war. He gave, in minute detail, an account of the events which happened, the action of Germany in derogation of American rights, the promises solemnly and repeatedly made by the Imperial German Government that these outrages would

be stopped, and the violation of every promise thus given.

No banker, no American, after hearing or reading Mr. McAdoo's address made at this convention will ever again ask: "What are we fighting for?" He



ROBERT F. MADDOX

Vice-President American Bankers Association; Vice-President Atlanta (Ga.) National Bank

will know beyond the possibility of any doubt whatsoever.

Let those who doubt our ability to finance the war read his statement that if our present capacity for raising funds for war is in the same proportion as shown in the Civil War, we can raise the stupendous sum of seventy-four billions of dollars!

Every American banker must have

HATHAWAY, SMITH, FOLDS & Co.

Commercial Paper

45 Wall Street, New York

**Chicago, St. Louis, Boston,
Philadelphia, Pittsburg,
San Francisco, Seattle**

Empire Trust Company

MAIN OFFICE:

**EQUITABLE BUILDING
120 BROADWAY, NEW YORK**

FIFTH AVENUE OFFICE:

580 FIFTH AVENUE, Corner 47th Street

LONDON OFFICE:

41 THREADNEEDLE STREET, E. C.

**This Company is the Fiscal Agent of the
State of New York for the sale of
Stock Transfer Tax Stamps**

shuddered in horror as he listened to the eloquent story of an eye-witness of the evidences of German brutality presented by Dr. Newell Dwight Hillis, pastor of Plymouth Church, Brooklyn, N. Y. No American will ever condone the crimes he recounted, nor stop fighting until those guilty of them are brought to justice, and until the autocratic military system which rendered them possible is swept forever from the earth.

In strong, devoted patriotism, the address of President Goebel was in absolute harmony with the exalted spirit of the convention. Here is a citizen of German birth whose noble example of patriotism, as Secretary McAdoo so fittingly said, many native Americans might well study and imitate.



JOHN MCHUGH

President Clearing House Section ; Vice-President Mechanics and Metals National Bank, New York



W. D. VINCENT

Former President Clearing-House Section American Bankers Association ; Vice-President Old National Bank, Spokane, Wash.

From the purely patriotic side, the forty-third annual convention of the American Bankers Association must remain in the memory of those who were there as the greatest assembly within the long and notable history of this organization. It spoke the purpose of the bankers in clear and unmistakable language, and their purpose is exactly that of the entire American people—to keep up this war without relenting until complete victory is achieved by the United States of America and her Allies and the terms proposed by us and our brothers in arms shall be unconditionally accepted by those now arrayed against us on the battlefields of Europe.

Every aim of the bankers, every act of the banks in relation to the vast enterprises of trade and industry, will steadily hold in mind this inflexible purpose.

In giving prominence to the addresses

U. S. Army or Navy

Red Cross or Y. M. C. A.

Letters of Credit are the safest and most convenient medium for carrying funds.

During the war we are issuing such Credits, *free of commission*, to officers and men in the U. S. Army and Navy, and to those engaged in Red Cross or Y. M. C. A. work.

We have also sent our American representative to France for the convenience of our friends, with headquarters at the office of the Credit Commercial de France, 20 Rue Lafayette, Paris.

BROWN BROTHERS & CO.

Philadelphia

NEW YORK

Boston

BROWN, SHIPLEY & COMPANY

Founders Court, Lothbury
LONDON, E. C.

123 Pall Mall
LONDON, S. W.

mentioned above, it has not been intended to lose sight of two other notable features of the convention—the addresses of Lord Northcliffe and Mr. Brand, both distinguished members of the British Commission now in this country. They brought to the bankers and to the people of the United States generally messages of the greatest importance, dealing with the actual financial and economic experiences of Great Britain in the war, and offering to us valued suggestions as to how our efforts may be made most efficient. These eminent gentlemen were listened to with the greatest interest, and their statements were repeatedly cheered. They were both most heartily thanked by a vote of those who heard them.

The resolutions presented by Mr. Jo-



OLIVER J. SANDS

Chairman Executive Committee National Bank Section; President American National Bank, Richmond, Va.



JOSEPH WAYNE, JR.

Chairman Committee on Resolutions; President Girard National Bank, Philadelphia

seph Wayne of Philadelphia, as chairman of the committee on resolutions, and adopted by the convention by an enthusiastic and unanimous vote, gave clear expression to the patriotic spirit of the American Bankers Association.

From the banking side, this convention was also one of great importance. The controversies which have sometimes raged over comparatively trivial matters were wholly absent, and there was a unanimity of sentiment which showed very clearly that in the face of emergencies the bankers of the country can sink their differences and unite for the common good. This spirit of the convention was most aptly expressed in the speech made by Mr. George M. Reynolds—introduced by President Goebel as the “best-loved banker in America.”

“The Bank That Service Built”

THE
SEABOARD
NATIONAL BANK

of the City of New York

Opened 1883

	Capital	Surplus and Undivided Profits	Deposits
Sept. 22, 1884	\$500,000	\$89,000	\$1,542,000
Dec. 1, 1885	500,000	120,000	2,493,000
Oct. 7, 1886	500,000	117,000	2,766,000
Oct. 5, 1887	500,000	127,000	2,536,000
Oct. 4, 1888	500,000	127,000	4,293,000
Sept. 30, 1889	500,000	132,000	5,157,000
Oct. 2, 1890	500,000	166,000	4,907,000
Sept. 25, 1891	500,000	183,000	5,507,000
Sept. 30, 1892	500,000	205,000	6,225,000
Oct. 3, 1893	500,000	246,000	5,481,000
Oct. 2, 1894	500,000	228,000	6,686,000
Dec. 13, 1895	500,000	235,000	7,681,000
Oct. 6, 1896	500,000	279,000	7,606,000
Oct. 5, 1897	500,000	306,000	11,058,000
Sept. 20, 1898	500,000	384,000	12,826,000
Sept. 7, 1899	500,000	555,000	15,144,000
Sept. 5, 1900	500,000	743,000	15,967,000
Sept. 30, 1901	500,000	1,015,000	20,171,000
Sept. 15, 1902	500,000	1,157,000	23,003,000
Sept. 9, 1903	500,000	1,338,000	16,618,000
Sept. 6, 1904	500,000	1,409,000	21,548,000
Aug. 25, 1905	500,000	1,478,000	23,612,000
Sept. 4, 1906	1,000,000	1,183,000	25,863,000
Aug. 22, 1907	1,000,000	1,434,000	23,809,000
Sept. 23, 1908	1,000,000	1,649,000	37,517,000
Sept. 1, 1909	1,000,000	1,765,000	30,992,000
Sept. 1, 1910	1,000,000	1,960,000	26,157,000
Sept. 1, 1911	1,000,000	2,082,000	30,548,000
Sept. 4, 1912	1,000,000	2,226,000	39,592,000
Oct. 21, 1913	1,000,000	2,525,000	32,797,000
Sept. 12, 1914	1,000,000	2,725,000	33,023,000
Sept. 2, 1915	1,000,000	2,845,000	44,234,000
March 7, 1916	1,000,000	2,856,000	55,858,000
May 1, 1916	1,000,000	2,860,000	60,143,000
March 5, 1917	1,000,000	3,078,400	57,840,000
Sept. 11, 1917	1,000,000	3,316,500	57,660,000

We Cordially Invite Business on This Record

S. G. BAYNE, President

C. C. THOMPSON, Vice-President

B. L. GILL, Vice-President

W. K. CLEVERLEY, Vice-President

L. N. DeVAUSNEY, Vice-President

H. W. DONOVAN, Cashier

O. M. JEFFERDS, Asst. Cashier

C. C. FISHER, Asst. Cashier

J. D. SMITH, Asst. Cashier

B. I. DADSON, Asst. Cashier

J. E. ORR, Asst. Cashier

Mr. Reynolds told the bankers that they must act unitedly in this crisis for the public good, and that they must overcome their prejudices in regard to rediscounting, and freely use the facilities of the Federal Reserve System in order that the tremendous demand upon the banks for credit may be fully met.

Passing from the dramatic aspects of this convention, which necessarily grew out of existing conditions, hardly less remarkable were other features of the Atlantic City meeting.

In the first place, the attendance at the general sessions was probably larger than ever before, the large hall of Young's Million Dollar Pier being well filled at each meeting.

But the most striking fact is the capacity which these members are showing for serious consideration of practical problems of banking and finance, largely made possible through the organization and development of the various sections, enabling the different classes of bankers to devote some of the sessions to the consideration of matters in which they are specially interested. The State Bankers Section, the National Bank Section, the Trust Company Section, the Savings Bank Section and the Clearing-House Section particularly afford such an opportunity. This tends to relieve the general sessions of the convention from the consideration of subjects which are in some cases of limited interest, thus offering more time to give to matters of general concern. At the same time any member who is interested in the proceedings of the various sections may attend their meetings, and as a matter of fact the sessions of the various sections were largely attended at this convention. It is only just to say that some of the very best work done at the convention of the American



FRANK W. BLAIR

President Trust Company Section ; President Union Trust Company, Detroit

Bankers Association is done by the Sections. This specialization in the organization has been also an important factor in raising the membership to the present high figures.

The American Bankers Association has now grown to be great and powerful, and the responsibility that rests upon it is worthily maintained. Its annual conventions are growing in interest and importance, and it may be said that this year's meeting was without parallel in holding the attention of the many bankers who were present from all sections of the country.

No good purpose is served by making comparisons between different conventions with respect to the entertainment

The Merchants National Bank

of the City of New York

FOUNDED
1803

Capital, Surplus and Undivided Profits over \$4,500,000

For over one hundred and fourteen years this bank has been noted for its conservative and efficient management, and offers today to the banking public the service of a thoroughly up-to-date institution.

Directors

J. E. Aldred
Aldred & Co., New York

Nicholas F. Brady
President, New York Edison Co.

Theodore E. Burton
President

Arthur V. Davis
President Aluminum Co. of America

Eberhard Faber
Vice-Pres. Eberhard Faber Pencil Co.

Raymond E. Jones
Vice-President

Arthur G. Meyer
Dry Goods Commission, New York

William F. Neu
Treas. Steel Roll Supply Co., N. Y.

Charles E. Potts
Pres. J. B. Locke & Potts,
Commission Merchants

Carl F. Sturhahn
U. S. General Attorney
Fire Reassurance Co. of Paris

William F. Wall
Pres. Wall Rope Works, New York

George Zabriskie
Zabriskie, Murray, Sage & Kerr,
New York

Advisory Council

Joseph W. Harriman.....New York
President Harriman National Bank

Anthony R. Kuser.....Newark, N. J.
Vice-Pres. Public Service Corpora-
tion of New Jersey

Waldo Newcomer.....Baltimore, Md.
President National Exchange Bank

Dean SageNew York

George C. Van Tuyl, Jr., Chairman
New York
President Metropolitan Trust Co.

Frederick T. Walker.....New York
Agent, Royal Bank of Canada

Officers

THEODORE E. BURTON, President
RAYMOND E. JONES, Vice-President
HARRY T. HALL, Vice-President

OWEN E. PAYNTER, Cashier
FRANK L. HILTON, Asst. Cashier
IRVING S. GREGORY, Asst. Cashier

228th Semi-Annual Dividend
Paid July 2d, 1917

features. In years gone by the charge has been made that the conventions were chiefly valuable as entertainments. If that charge was ever true, it is not so now. The conventions of the American Bankers Association are serious, dignified gatherings of strong and earnest men who meet once a year to renew acquaintances and to consider questions of vital concern to the banks and to the whole people. The entertainment features are purely incidental, and by no means overshadow the deliberations of the convention. This year there were but a few modest entertainments provided, but Atlantic City itself furnished ample amusement for everybody. Governor Edge and Mayor Bacharach told the bankers that they were welcome—a fact of which they had no doubt whatever.

In many respects Atlantic City constitutes an ideal place for a large convention of any kind. The sea and the many attractions are strong magnets, while the numerous fine hotels with their immense reception halls permit the assembling of large numbers of people without the least discomfort. Proximity to the great eastern cities is also an advantage. These and other factors have led to the suggestion that Atlantic City be made the permanent meeting place for future conventions. Many claims could be put forth for a decision to this effect, but there are two objections of some weight. The honor of entertaining the convention of the American Bankers Association is one that the bankers believe should be passed around among the leading cities of the country, and then Atlantic City, with its many advantages, is yet less centrally located than some other points. While, therefore, Atlantic City may not for the present have the honor of entertaining

the bankers each year, it is certain, judging by their pleasant experience this time, that they will be glad very often in the future to visit again "America's greatest playground."

SYNOPSIS OF PROCEEDINGS

The forty-third annual convention of the American Bankers Association was called to order by President P. W. Goebel at Young's Million Dollar Pier, Atlantic City, N. J., September 27, at 9:30 o'clock. After addresses of welcome by Governor Walter E. Edge of New Jersey and Mayor Harry Bacharach of Atlantic City, President Goebel delivered his annual address, which was in part as follows:

EXTRACTS FROM PRESIDENT'S ANNUAL ADDRESS

This is one of the most eventful years in the history of nations. If we have not made progress, we have made haste. I think we have made progress. It is surely progress when exigency demands that we make the wisest and most economical use of our resources. It is perhaps strange that this mighty war has not yet added anything of importance to the list of human discoveries and inventions. In the past fifty years there have been many—more than it was possible to adapt to practical uses. There has been a demand for new things, for new appliances of various kinds. Inventive genius has been stimulated by offers of rewards. Men and governments have been eager to try anything of promise, but, as yet, nothing has been forthcoming. It is as if the world had been saturated with products of human ingenuity and there was need to wait for new ones until we have learned to use wisely those which we have. So we are learning under the pressure of war new lessons in adaptability, in economy, in thrift, in production; we are learning how better to use our soil, our mines, our factories, our railroads, our ships, our men, our money and our credit.

We have much to learn yet. We are far from the goal, but we seem to me to have gotten beyond the novice stage. We seem to be moving forward now with steadiness and precision. If we have learned our first lesson well, we shall continue to move in that manner to final victory, victory over the common enemy of the world and victory



THIS bank has been primarily established for the facilitation of trade between the United States and the Philippine Islands, and offers exceptional facilities in respect to the negotiation of Bills of Exchange, opening import and export Letters of Credit, transmission of funds, etc.

Philippine National Bank

Woolworth Building

New York

—a greater victory—over our indifference, our wastefulness, our greed and ourselves. It is only with confidence and pride that we can watch the march of events—the disappearance of the differences that divide us, the gradual but steady converging of the lines that mean a people as well as a nation united firmly and forever in loyal adherence to democratic principles.

This most eventful of years in the history of nations has also been the most eventful in the history of the American Bankers' Association, and the most active. Banking has been subject to all the influences that affected other lines of business endeavor. The misgivings and uncertainties have touched us all. Precedents have been discarded, traditions have been cast aside and we have gone on adapting ourselves to new and strange circumstances with a surprising and gratifying readiness. Our Association has also shown remarkable adaptability. Not only has it attended to its routine of affairs, but it has gone afield and found new work to do for the common benefit.

The Federal reserve system, not only as a protection against panic, but as an operating banking scheme, having a position in the financial doings of the day, has been the bulwark of the country in these eventful times. I shudder to think of what would have inevitably happened if we had been at the mercy of the old banking system. During the past year, and especially since the declaration of war, the reserve system has given a new demonstration of its ability to insure financial peace.

To the Federal Reserve Board every banker has looked with confidence. The Board is charged with great responsibilities, but the bankers are not relieved of their share of the obligation because the Board exists. The members of the Board have unusual opportunities to secure information and to study conditions. They have made liberal regulations. They have made rediscounting easy. They urge the amendments to the Reserve Act which have proved of decided advantage. The privilege of borrowing against eligible paper as collateral for fifteen days has been of the greatest convenience and is perhaps more extensively used than the rediscount privilege.

The change in reserve requirements has caused much discussion. The fear of an undue credit expansion and a currency inflation is frequently expressed. Under the existing conditions, it seems to me that both credit and currency expansion are necessary. We are all inclined to measure the possibilities in such a case by the disastrous experiences that attended expansion or the need for it under the old system. We must remember that we now have the machinery by which the tendency to expansion can be controlled, and we have watchmen. Under any plan of banking, confidence must be placed in some human element. No auto-

matic system for the regulation of credit has yet been devised; none is possible. The situation, as I view it, is perfectly safe, provided we exercise good judgment and requisite care. We now control the system. It no longer controls us.

There may be danger in the change in reserve requirements, but it has not yet manifested itself. Here again I feel that the application of sound judgment and foresight is more important than fixed percent-



PETER W. GOEBEL

Former President American Bankers Association;
President Commercial National Bank,
Kansas City, Kansas

ages of reserves to liabilities written in the law. If experience shows that bankers generally haven't sound judgment, the reserve provision can be readjusted. It is our job to keep our banks sound, and I am not yet willing to believe that we are not able to do it.

The reserve banks should be used by and receive the support of every banker. It is our system, and the greater use we make of it, the stronger it will be. We make our banks stronger by adding to the strength of the reserve system. It is, therefore, my opinion that state banks, particularly those whose business is chiefly commercial, will

The Yokohama Specie Bank Limited

[Yokohama Shokin Ginko]

HEAD OFFICE, YOKOHAMA, JAPAN

Capital Subscribed .

Capital paid up . . .

Reserve Fund

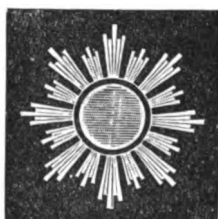

(\$0.50=1 Yen)

. . . Yen 48,000,000

. . . Yen 36,000,000

. . . Yen 22,100,000

DIRECTORS

JUNNOSUKE INOUE, Esq., President

YUKI YAMAKAWA, Esq., Vice-President.

NAGATANE SOMA, Esq.

KOKICHI SONODA, Esq.

RIYEMON KIMURA, Esq.

ROKURO HARA, Esq.

MASNOSKE ODAGIRI, Esq.

TCHUNOSUKE KAWASHIMA, Esq.

BARON KOYATA IWASAKI.

KONOJO TATSUMI, Esq.

BRANCHES AND AGENCIES

TOKYO
OSAKA
LONDON
BOMBAY
SYDNEY
HONGKONG
HANKOW

CHI-NAN
PEKING
DAIREN
ANTUNG-HSIEN
FENGTIEN
CHANGCHUN
KOBE

NAGASAKI
LYONS
HONOLULU
CALCUTTA
SINGAPORE
SHANGHAI
TSINGTAU

TIENTSIN
NEWCHWANG
RYOJUN
LIAOYANG
TIEHLING
HARBIN

Agencies in United States

New York

San Francisco

Los Angeles

Seattle

The Bank buys and receives for collection Bills of Exchange, Issues Drafts and Telegraphic Transfers and Letters of Credit on its various branches and elsewhere, and transacts a general Banking Business.

NEW YORK OFFICE - - - 120 BROADWAY

R. ICHINOMIYA, Agent

find their way, one by one, into the system. It must be so because self-protection is a powerful motive, quite powerful enough without the aid of patriotism. As it is now, the state banks are the beneficiaries of a stability to which they do not generally contribute.

All the banks of the country have extraordinary duties to perform in these trying times. They have assumed these new tasks willingly. One of them is to assist the government in the sale and distribution of war loan bonds. This duty naturally falls to the banks. The banker is the financial adviser of his community. To him the people turn even when the government calls and patriotism dictates. The financial machinery is under his control. So when the Secretary of the Treasury called on the banks to assist in floating the two billion dollar Liberty Loan issue, the banks, with scarcely any exception, devoted their entire energies to the task and greatly aided in the achievement of the splendid success of that campaign.

The business of this country is war. Business not directly necessary to war must be, at least, incidental to it. It is no time to consider new enterprises. However profitable one may appear, unless its immediate purpose is to increase the chance of success in war, it had better be postponed. We need no new and untried methods in either business or banking. The matter of first importance is that bankers should have their institutions fully equipped and ready to meet extraordinary as well as ordinary demands upon them.

The banks are obligated not only to look after the commercial needs of their customers, but also to assist them to a full participation in all government loans. In the last analysis, it is only through the banks that bond issues can be successfully placed. The banks have, therefore, to bear this new responsibility in addition to all the others.

The liberal extension of credit for all constructive enterprises is absolutely essential. For the banker to withhold credit, when the credit is to be used in production, is near treason; it is giving aid and comfort to the enemy; it is impairing the chances of success in war. The extension of credit for the sake of profit or for speculative purposes is almost as vicious as its refusal for productive enterprise. Feeding a speculative fever cannot fail to have an after-war effect; the trouble sure to follow might leave its tracks for a century. I do not wish to prophesy. Just what may happen after the war no man knows; but we do know that if we follow sane rules, if we keep our banks clean and liquid now, the inevitable after-war effects will be more easily handled.

Let us have no misunderstanding as to what liquidity now means. In these days it means something more than quick assets. It means the possession of a good proportion

of paper eligible for rediscount at the Federal Reserve Bank, both by member and by non-member banks. No bank should hesitate to have recourse to the rediscount privilege. Reliance must be placed on the reserve banks. They are there to be used. The railroads were the first of all the great economic forces to organize themselves for the service of war. They readjusted their schedules, forgot profit and turned themselves to the great task of maintaining transportation and insuring the distribution of commodities whose quantity was unprecedented.

The railroads have been most patriotic, but it seems to me that the real lesson is found in the lack of railroad facilities, in the failure to have a reserve which would permit the railroads to meet the emergency. Despite the great efforts of the masters of transportation, the greatest difficulty is found in moving commodities. The long campaign of repression is bearing bitter fruit. The situation bespeaks the need of justice for the railroads, of fair rates, of liberal treatment and of the summary discontinuance of persecution.

The conduct of the people of the country has been exactly what we would expect. On them, on the home, falls the great burden. It is in the hearts of the people that we must look for the final assurance of success in every venture, and in their hearts now we find the confidence of victory. The people must supply the soldiers, support the charities, maintain the Red Cross, do the saving, furnish the labor and pay the bills. The army and navy are filled with volunteers, the draft of men was accepted without trouble, the training camps for those ambitious to lead overflowed. The first Liberty Loan was oversubscribed. Lawns were turned into gardens. Production has been greatly increased. The boys are drilling. The girls are knitting. Everything is as it should be with the people. They look with patience and hope to the leaders who will devise the ways and provide the means to secure the return of peace.

Peace seems a long way off, but whether it comes this year or next, or years hence, it will be unworthy the name if it is not the peace of victory. To the victory we desire and are going to have, we need not look with a blush of shame. We desire no conquests of land or men. Now, as in the past, we ask only freedom for those enslaved and more freedom for ourselves—the right to be unmolested where commerce leads us, where we may exchange what we have for what we want; the right to gain knowledge from others and implant in the hearts of men the desire for virtue, truth and righteousness. Our consciences are clear and our duty is plain. Each one must do the best that is in him in whatever position he is placed. To the home we owe devotion, to the country, loyalty; to ourselves

The Bank of Taiwan, Ltd. (TAIWAN GINKO)

Incorporated by
Special Imperial Charter, 1899



(\$0.50 = 1 yen)

Capital Subscribed	yen 20,000,000
Capital Paid-up	yen 17,500,000
Reserve Funds	yen 5,080,000

Head Office
TAIPEH, FORMOSA

BRANCHES

JAPAN—Tokyo, Yokohama, Osaka, Kobe.
FORMOSA—Ako, Giran, Kagi, Karenko, Keelung, Makung,
Pinan, Shinchiku, Tainan, Takow, Tamsui, Taichu.
CHINA—Amoy, Canton, Foochow, Hankow, Kiukiang, Shang-
hai, Swatow.
OTHERS—Hongkong, London, Singapore, Bombay, Soera-
baya, Semarang.

London Bankers
CAPITAL & COUNTIES BANK
LONDON & SOUTHWESTERN BANK
PARR'S BANK

New York Correspondents
IRVING NATIONAL BANK
NATIONAL CITY BANK
HANOVER NATIONAL BANK
NATIONAL BANK OF COMMERCE
GUARANTY TRUST COMPANY
EQUITABLE TRUST COMPANY

The Bank has Correspondents in the commercial centres of
Russia, Manchuria, Indo-China, India, Philippine Islands, Java,
Australia, America, etc.

AGENCY OF THE BANK OF TAIWAN, LTD.,
Room 308 The City Investing Building.
Tel. Cort. 2414-2415 : : 165 Broadway, New York

adherence to the ideals of the Republic. We cannot fail.

Secretary McAdoo was to have spoken at the morning session, but was unable to be present until the following day. His place on the programme was taken by Benjamin Strong, Jr., governor of the Federal Reserve Bank of New York, who spoke on the Federal Reserve System.

George M. Reynolds, a former president of the American Bankers Association, and president of the Continental and Commercial National Bank, Chicago, spoke on "Business in War Times."

The bankers, said Mr. Reynolds, has his finger on the pulse of the nation's business, the banker is doing not only what every other business man does, but he is doing more in cooperating with the government," he said, the banker provides money for the man furnishing the foodstuffs. He finances the farmer that he may raise his crops and then enables him to transport them. In every hamlet of the country is a soldier. He wears no uniform nor shoulder straps, but he is performing a work that is the second essential for winning the war. The first essential is the armies at the front.

Some persons like to pretend that the American business man is not patriotic and that bankers are money-grabbers and have no interest except in the things they can get. But I believe that the banker is the foremost man in his community in laboring for the public good and the general welfare. You bankers have come together in this convention to record your patriotism and it is no compliment that you are patriotic. It is in the discharge of our duties to our consciences that the public will know what we stand for long before the war is over. The men who go into the trenches are the ones who are entitled to the greatest glory and honor, because they have placed their very lives in jeopardy for this righteous cause. But though we are in this second place, it is absolutely essential if we are to win the war, that behind the men in the trenches there be a great industrial army which shall send over to them an unceasing supply of food, material and munitions. But in every hamlet throughout this country there is a soldier serving his country. He may not be in uniform, he may not have a gun over his shoulder, but he is doing the best he knows how. The biggest problem before the nation today is the trans-

port of men and materials abroad. For this Congress has already appropriated a billion dollars. All business problems must be met in this big way. Each man should treat the subject as though he were the one personally attacked. It is unfortunate that we



GEORGE M. REYNOLDS

Former President American Bankers Association;
President Continental and Commercial
National Bank, Chicago

should have to discuss taxation at the same time as the second loan comes up.

Efficiency in business means cooperation all along the line, and efficiency can be shown in individual work if we get this cooperative spirit among ourselves. Our only desire and duty is to back the President and the Administration. Then we need have no fear as to our success in the coming loan. All questions of policies, politics or partisanship should extend no further than discussion.

What is the duty of the banker? The raising of foodstuffs is the thing of the first importance and all bankers must not only help to promote greater acreage but a better

Kings County Trust Company

Brooklyn, New York

Established 1889

Capital	- - - -	\$500,000.00
Surplus	- - - -	\$2,000,000.00
Undivided Profits	- - - -	\$841,000.00

OFFICERS

JULIAN D. FAIRCHILD, President

Vice-Presidents

JULIAN P. FAIRCHILD	WILLIAM HARKNESS	D. W. McWILLIAMS	WILLIAM J. WASON, Jr.
THOMAS BLAKE, Secretary		HOWARD D. JOOST, Asst. Secretary	
J. NORMAN CARPENTER, Trust Officer		GEORGE V. BROWER, Counsel	

Starting with a Surplus of \$250,000, our Surplus and Undivided Profits are now almost six times our Capital.

Brooklyn and other New York business of out-of-town banks solicited



CHARTERED 1886

Brooklyn Trust Company

Main Office—177 MONTAGUE ST., BROOKLYN, NEW YORK

Branch—1205 FULTON ST.

Manhattan Branch—90 BROADWAY

Departments: BANKING—TRUST—FOREIGN EXCHANGE

OFFICERS

DAVID H. LANMAN	EDWIN P. MAYNARD, President	HERACE W. FARRELL	Asst. Secretary
FRANK J. W. DILLER	Vice-President	HERBERT U. SILLECK	Asst. Secretary
WILLIS McDONALD, Jr.	Vice-President	AUSTEN W. FENCHOEN	Asst. Secretary
FREDERICK T. ALDRIDGE	Vice-President	GILBERT H. THIRKIELD	Asst. Secretary
WILLARD P. SCHENCK	Secretary	FREDERICK B. LINDSAY	Asst. Secretary
	FREDERIC R. CORTIS, Auditor		

quality of the things produced. He must do all that he can to support legitimate business, for if we refuse to do so it will be like throwing sand in the gearbox of our war business. The banker must cast off that old fallacy of the fear of showing rediscunts. Let him cooperate with the Federal Reserve system and at the same time cooperate with the business in his own community.

Do your duties quietly at home, without brass bands, and you can do much, in your own way, for democracy and national self-defense. And when this war is over America will stand forth conspicuous among all the nations of the world who have stood for justice, freedom and right.

The afternoon session was occupied by listening to reports of the various Sections, until 2:30 o'clock, when Lord Northcliffe, chairman of the British War Commission to the United States, spoke on "How Long." Lord Northcliffe said in part:

There is one subject upon which many of my American friends think I can speak, and that is in respect of the loans made by the United States to the Allies. I have found well-educated people who think that these loans cross the Atlantic in some mysterious way. As a matter of fact, every cent advanced is spent in an increase of wages in Bridgeport, in Bethlehem and in other of your cities. All the money is spent here, and much of the money will come back in the form of subscriptions to the Liberty bonds, for I have no doubt that the American workingman will subscribe as liberally as have our workmen for our national loans. And I may tell you that last loan exceeded six billions of dollars, and that there were five millions of subscribers to it, many of them men working at the forges, in the shops, on the railroad, in the counting houses, on the farms, and even on the ships.

These loans to the Allies, in my opinion, are beneficial quite apart from the fact that they are supporting the war through the navies of France, Great Britain and the armies in Belgium and in Russia. We have come to the conclusion that though the evils of war are great, the circulation among the workers is very beneficial. Wages were never higher in Great Britain than they are now, and I know from personal investigation that that is so here in the United States. Far be it from me to glorify war. I have seen too much of the horrors of it to ever care to see it again; but we must look at both sides of it, we must realize that if we are to get in subscriptions to these loans the working people must have their

share of the vast amount of capital necessary to the waging of the war.

The belief in a short war was widely spread by pernicious propagandists, who told the world that the war would be short in order that the world should not prepare. They throw out these peace delusions week after week, not with any intention of accomplishing peace, but with the intention of



LORD NORTHCLIFFE
Chairman British War Mission

weakening the Allies' preparations. That is so very obvious that it is surprising that any intelligent person should take any notice of those peace offerings.

If you look carefully at them you will see that they never mean to give back or move back an inch from the ground they have stolen. They never cease their violence. You will notice that even at the moment that one German department is talking about peace another German department is bringing out a new, horrible engine of war. Their Government may be a very efficient one from their point of view. From my point of view it is very badly co-ordinated. I shall believe in the prospect of peace when I find that the Germans have released some of the Belgians whom they have enslaved and some of the French women they have dragged into captivity and worse. They are doing nothing

**United States
Mortgage & Trust Company**

**Capital and Surplus
\$6,000,000**

This Company invites inquiries from members of the American Bankers Association desiring new or additional facilities in New York City.

*Interest Credited Monthly
on daily balances*

**Main Office: 55 Cedar St.
New York**

Announcing the consolidation of Peoples Savings Bank, Pittsburgh, Pa. (founded 1866), and The Safe Deposit and Trust Company of Pittsburgh (founded 1867), to be known after September 29th, 1917, as

**PEOPLES
SAVINGS
AND TRUST CO.
OF PITTSBURGH
FOUNDED 1867
CAPITAL AND SURPLUS \$9,000,000
WHERE WOOD CROSSES FOURTH**

President..... A. C. ROBINSON
Vice-President..... D. McK. LLOYD
Vice-President..... ROBERT WARDROP
Vice-President..... W. D. GEORGE
Vice-President..... J. O. MILLER
Secretary and Treasurer..... J. BOYD McKOWN
Assistant Secretary..... S. E. HARE
Asst. Treas. & Mgr. Mgt. Dept..... C. W. KISER
Assistant Treasurer..... GEORGE ARMOR
Trust Officer..... W. H. ERRETT
Asst. Trust Officer..... M. B. HOLLAND
Manager Real Estate Dept..... W. K. BROWN
Auditor..... S. F. MURPHY
Assistant Auditor..... S. MUNNELL, Jr.
Manager Vault Dept..... THOS. L. SHEAFER

DIRECTORS:

W. K. Shiras	Benjamin Thaw
D. McK. Lloyd	Henry Chalfant
J. D. Lyon	Fredrick C. Perkins
George E. Painter	J. M. Shields
Robert Wardrop	Hon. William A. Way
George W. Crawford	Alexander C. Robinson
John H. Ricketson, Jr.	W. L. Clause
T. H. B. McKnight	F. H. Lloyd
W. D. George	W. C. Robinson
	J. O. Miller

**Resources over - - \$21,000,000
Trust Funds over - \$39,000,000**

Nassau National Bank of Brooklyn

46 Court Cor. Joralemon St., Brooklyn, N. Y.

Member of New York Clearing House

Capital \$1,000,000

Surplus (earned) \$1,000,000

OFFICERS

G. FOSTER SMITH, President
T. SCHENCK REMSEN, Vice-President

H. P. SCHOENBERNER, Cashier
ANDREW J. RYDER, Assistant Cashier

The Largest National Bank on Long Island

Notes and Drafts

Notes and Drafts

Send Your New England Collections to

**Dorchester Trust Company
Boston, Mass.**

Absolutely Direct Service to Every Point in N. E.

No Exchange Charges

of the kind. They are following the most ancient device in history. They are talking about peace and making war.

When I think of all the sad things that I have witnessed in the last three years I have this one consolation: That after all, as your chairman said today, the war is bringing the allied peoples together. We have all learned many things about France which we did not know and we are all proud of France. We have seen what a small nation—the 6,000,000 of Belgians that are still living under the heel of Prussia—we have seen with what dignity they can stand the presence of the oppressor. We have seen that Italy, goaded for years by Austria, has decided to throw off the chains that have been placed around her enterprise and her freedom. And we have seen here in the United States a peaceful people like your people and our people aroused to the fact that it is essential for the world's happiness that the state of tyranny imposed by Prussia shall not be further extended.

I can assure you that we from Great Britain, while very confident of our power to defend ourselves, most cordially and gladly welcome the help that is coming from the magnificent young men that I see in your training camps.

This great assemblage of bankers is further proof that the great burden England has borne in financing the war is to pass into worthy and generous hands, for if the Americans are extravagant—and I am afraid they are—it is equally true that they are a generous people, and already, by the troops they have sent to Europe and by the ships full of supplies that they have sent, they have shown earnest proof of the fact that they are heart-to-heart and hand-in-hand with those who have borne this burden for the last three years.

Following Lord Northcliffe President Nicholas Murray Butler of Columbia University, New York, made the most notable address of the convention, being frequently interrupted by enthusiastic cheering, especially when he demanded that Robert M. La Follette be expelled from the United States Senate.

Dr Butler said the war against Germany was being fought in two places; that this country was fighting across the sea, and fighting here, where "evil-minded sedition, conspiracy, cowardice, and treason" existed.

"Our soldiers," he said, "can fight a soldier's enemy, but you and I have got to fight sedition and cowardice. Have the American people lost their capacity for corporate indignation? There is a provision in the Constitution of the United States that

either house of Congress may by a two-thirds vote expel a member. What are they thinking about, those honorable, patriotic men, to sit there and be contaminated by having Robert M. La Follette breathe the same air with them? Have we no courage? Are



NICHOLAS MURRAY BUTLER
President Columbia University

we so mealy-mouthed that we are afraid to make trouble with an object like that?"

Applause and laughter followed these words, and Dr. Butler continued:

"Believe me, gentlemen, this is no laughing matter. It is the solemnly serious problem before our people. The other day Charles Edward Russell, a distinguished Socialist, who went by appointment of the President of the United States on the recent mission to Russia, stated in a public place that the Russian downfall was in no small part due to the reading by those poor ignorant Russian soldiers of this man's speeches in the Senate and on the hustings as evidence that the United States was not united and sincere in this war. Why, you might just as well put poison in the food of every boy

Old Colony Trust Company

BOSTON

Condensed Statement September 6, 1917

ASSETS

Loans	\$102,940,611.76
Investments	8,650,684.75
Exchanges for Clearing House.....	1,860,611.73
Customers' Liability under Acceptances and Letters of Credit.....	14,458,488.58
Banking Offices	2,635,000.00
Cash and due from Banks.....	34,364,422.23
Total	\$164,909,819.05

LIABILITIES

Capital, Surplus and Undivided Earnings.....	\$13,780,383.38
Reserved for Interest and Taxes.....	904,866.53
Acceptances and Letters of Credit.....	14,982,720.60
Deposits	135,241,848.54
Total	\$164,909,819.05

MEMBER OF THE FEDERAL RESERVE SYSTEM

Capital, \$1,000,000

Surplus, \$1,000,000

Total Resources, \$17,000,000

Incorporated 1792

The National Union Bank

BOSTON, MASS.

Boston's oldest bank, originally chartered in 1792, with an unbroken record of continuous dividends for one hundred and twenty-five years.

Its medium size gives assurance of personal attention to its depositors.

OFFICERS

HENRY S. GREW, President

WILLIAM S. B. STEPHENS, Vice-President
ALEXANDER WHITESIDE, Vice-President

ARTHUR E. FITCH, Cashier
JOHN W. MARNO, Asst. Cashier

that goes to his transport as to permit that man [La Follette] to talk as he does!

"Mr. President, I feel stirred from the very depths of my heart when I think that there are among our people those in high public place who have been trusted by confiding constituencies who will with their eyes wide open betray the Government of the United States in this war. And do you see the significance of these coolings about peace which come from Berlin? Do you recognize their significance? They are intended to weaken your effort and mine, in the hope that we may stay our hand before the new world of which we are in search has been discovered and organized. Any human being who asks for peace short of unconditional surrender is asking us to organize for another and still greater war. Peace is not an ideal. Peace is a state attendant upon the accomplishment of an ideal. The ideal is freedom, liberty to satisfy human wants and aspirations. Give us those and peace is secure."

THE SECOND DAY

At the second day's session Hon. Carl Vrooman, Assistant Secretary of Agriculture, spoke on "Civic Soldiers in the War for Democracy," especially describing what the farmers of the country were doing in helping win the war.

Hon. W. G. McAdoo, Secretary of the Treasury, then spoke on "The Second Liberty Loan." Secretary McAdoo was received with great enthusiasm, and his address was frequently cheered. It is not possible here to present a full report of this speech, which was of great length and of remarkable ability. The Secretary's statement of our reasons for entering the war was clear, full and convincing and absolutely accurate from the standpoint of history. The Secretary said in opening his address:

Gentlemen of the American Bankers Association, it gives me great pleasure to meet the members of this association and to express to you in person my deep appreciation of the patriotic and cordial support the bankers of the United States have given to the Government in the important financial operations in which the Treasury has been engaged since the outbreak of the European war. They deserve high commendation also for the notable services they rendered and

for the contributions they made to the Red Cross war fund. Nothing could be more creditable to the American people than their extraordinary generosity in providing this monumental fund for mercy.

The credit of the Federal Government throughout its history has been maintained inviolate; its obligations have always been scrupulously observed; its engagements have always been honorably fulfilled. The national credit is the first bulwark of defense of the nation's rights. If that credit be impaired, the whole economic and financial structure of the country is imperiled. Finance is so fundamental to war that the first duty of every nation upon the outbreak of hostilities is to conserve its financial resources and to make the national credit impregnable and sufficient for all the purposes of the war.

In all of the great financial operations in which the Government has been engaged in the past, and in all of those in which it must engage in the future, the American banker must, because of his knowledge, experience, ability and influence, become the first line of defense and offense. His thorough cooperation with the Government relieves the task, however stupendous, of any doubt. To you, the patriotic bankers of America, has come a great responsibility and a great opportunity—the responsibility of helping your Government solve its huge financial problems successfully, and the opportunity to serve your country in ways peculiarly useful and effective at this time.

He made the following brilliant close:

Fellow countrymen, we are at one of those great points in the progress of civilization where pregnant issues for the whole human race are to be determined. It is an inspiring thought that noble, free, peaceful, and liberty-loving America has been called by God to powerfully influence, if not to determine, the course of future events. We have a grave responsibility, and I know that we shall discharge it worthily of American patriotism and American idealism. These problems are of unparalleled novelty and magnitude. The means of determining action must frequently be more instinctive than logical. We are traversing unknown and uncharted seas. Our compass must be the steadfast cooperation of the best wisdom and intelligence of the country, inspired by a lofty patriotism which neither obstacles can discourage nor death defeat. America's sacred rights must be vindicated; a just and lasting peace must be established; democracy must be triumphant; despotism must be destroyed; and, when these great things have been accomplished, everywhere throughout the length and breadth of the civilized world men shall proclaim noble America as the valiant knight who came

State Street Trust Company

BOSTON, MASS.

MAIN OFFICE, 33 STATE STREET

BRANCH OFFICES

Massachusetts Avenue Branch
Cor. Massachusetts Ave. and Boylston St.

Copley Square Branch
579 Boylston St.

Interest Allowed on Accounts of \$300 and Over

DEPOSITS

July 1, 1910	-	-	-	-	-	\$12,448,680.93
July 1, 1912	-	-	-	-	-	15,646,215.53
July 1, 1914	-	-	-	-	-	17,063,395.45
July 1, 1916	-	-	-	-	-	26,164,957.12
July 1, 1917	-	-	-	-	-	28,494,306.44

Beacon Trust Company

TWO OFFICES

20 MILK STREET

3 SO. MARKET STREET

BOSTON, MASS.

Capital	-	-	-	\$600,000.00
Surplus and Profits	-	-	-	\$1,100,000.00
Deposits	-	-	-	\$15,075,000.00

	Capital	Surplus and Profits	Deposits
January 1, 1905	\$400,000.00	\$164,710.00	\$1,795,937.33
January 1, 1908	400,000.00	347,800.00	3,579,671.07
January 1, 1911	600,000.00	498,600.00	9,093,040.59
January 1, 1914	600,000.00	791,110.30	10,958,625.10
January 1, 1917	600,000.00	1,056,522.94	14,166,794.09
October 1, 1917	600,000.00	1,142,763.54	15,075,640.08

CHARLES B. JOPP, President

C. L. BILLMAN, Vice-President and Treasurer

F. B. LAWLER, Vice-President

GEORGE H. POOR, Secretary

ROBERT G. SHAW, Jr., Asst. Treasurer

ALFRED S. NELSON, Asst. Treasurer

DEPOSITARY FOR REORGANIZATION PURPOSES

Interest Paid on Deposits of \$300 or over

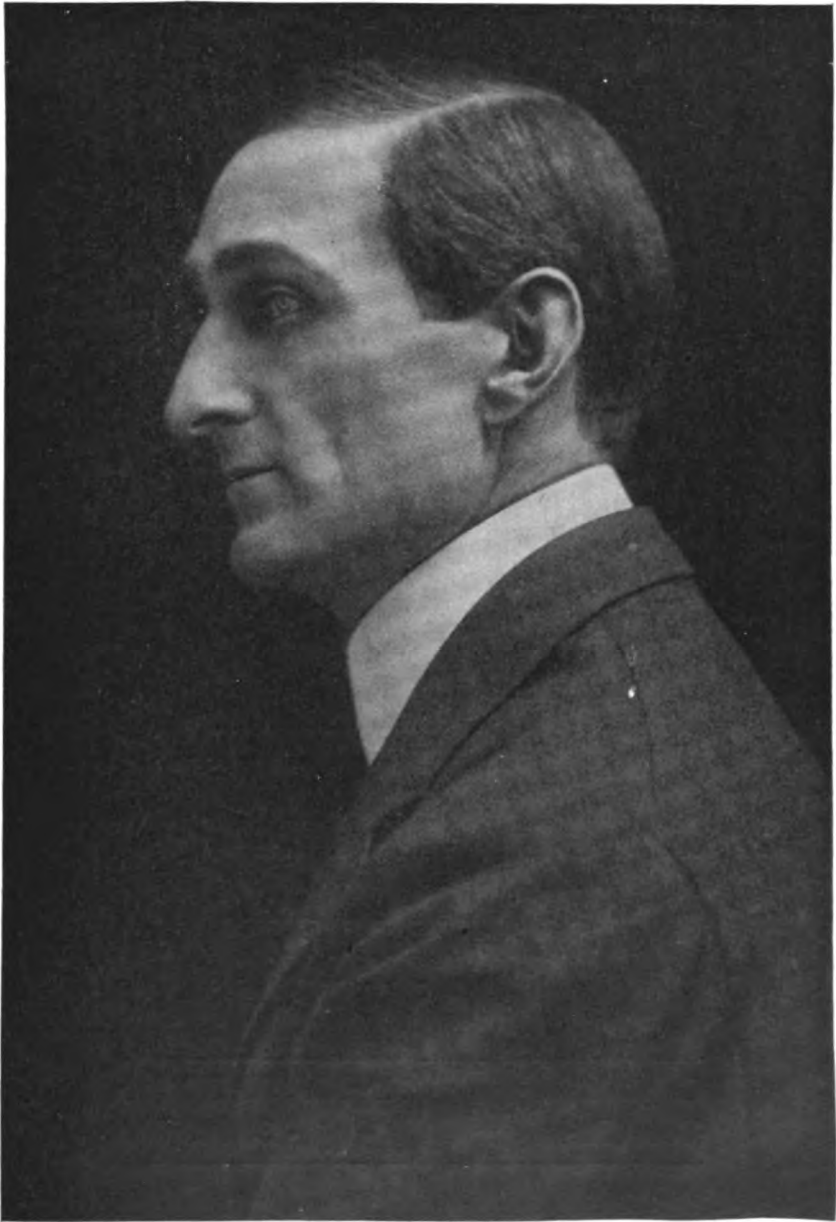

HON. W. G. McADOO
Secretary of the Treasury

upon the scene in the blackness of the night and rescued civilization!

In the afternoon the leading address was made by Rev. Newell Dwight Hillis, pastor of Plymouth Church, Brooklyn, N. Y. Dr. Hillis gave a most

vivid account of the effects of German operations in France and Belgium, as witnessed by himself.

The convention was brought to a close by the adoption of resolutions and the election of officers as follows: President,

G. M. WRIGHT, *Pres.* J. L. ELLSWORTH, *V.P.*
 R. H. MANN, *V.P. & Tr.* E. W. WALDO, *As. Tr.*

Park Trust Company
 Worcester, Mass.

Municipal and Corporation Bonds

We purchase outright entire issues of Municipal and Corporation Bonds that meet the approval of our Investigating Departments.

We offer and recommend these bonds for the investment of Institutions, Trustees and Individuals.

We invite correspondence from all who are interested in the purchase or sale of bonds of this character.

E. H. ROLLINS & SONS
 Boston New York Philadelphia
 Chicago Denver
 San Francisco Los Angeles London

THE FOURTH-ATLANTIC NATIONAL BANK OF BOSTON

Capital, Surplus and Profits, \$3,400,000
Total Resources, - - 30,800,000

OFFICERS

HERBERT K. HALLETT, <i>President</i>	EDGAR F. HANSCOM, <i>Assistant Cashier</i>
WILLIAM N. HOMER, <i>Vice-Pres. & Cash.</i>	NATHAN N. DENISON, <i>Assistant Cashier</i>
ARTHUR W. HAINES, <i>Vice-President</i>	GUSTAVE A. BLEYLE, <i>Assistant Cashier</i>

STATE STREET, Corner KILBY, BOSTON



The Breakers, another of the fine Hotels of "America's Greatest Playground"

Charles A. Hinsch, president Fifth-Third National Bank, Cincinnati, Ohio; vice-president, Robert F. Maddox, president Atlanta National Bank, Atlanta, Ga.

Chicago was chosen as the place for holding next year's convention.



TERSE STATEMENTS

President Goebel: The business of this country is war.



Joseph Hirsch, chairman agricultural commission:

The agricultural commission of the American Bankers Association enters upon this, the fifth year of its existence, at a time when measures the commission has been advocating ever since its organization—increased food, feed and livestock production—have become a vital factor in the successful prosecution of the great enterprise upon which

this nation has engaged—that lofty adventure which, untarnished by desire for material benefit, aims to make the peoples of the world free, as we are free, to enjoy the blessings of liberty and self-government.

Leonard G. Robinson, president Federal Land Bank, Springfield, Mass.:

In proof of the fact that our agricultural industry has been under-financed, a few comparative figures will suffice. The total investment of the railroads in this country, according to the report of the Interstate Commerce Commission for 1915, is, in round figures, \$17,000,000,000; the bonded indebtedness of these railroads is \$12,000,000,000, or sixty-five per cent. The physical valuation of the farms in the country is \$40,000,000,000, while the total indebtedness on them has been estimated at \$6,000,000,000, that is, only nineteen per cent. of their valuation.

Secretary Farnsworth:

When our books were balanced on August 31, 1917, our association membership was 17,328. One year ago we had enrolled 16,016 members.

Carl Vrooman, Assistant Secretary of Agriculture:

Industrial Trust Company

PROVIDENCE, R. I.

Branches

PAWTUCKET	NEWPORT	WOONSOCKET
BRISTOL	WARREN	PASCOAG
WICKFORD		WESTERLY

Largest Bank in Rhode Island

Capital	-	-	-	\$3,000,000
Surplus	-	-	-	4,000,000
Total Assets Over	-	-	-	70,000,000

Officers

SAMUEL P. COLT, Chairman of the Board of Directors				
H. MARTIN BROWN, President				
JOSHUA M. ADDEMAN,		HENRY B. CONGDON,		
	Vice-President			Secretary
JAMES M. SCOTT,		J. CUNLIFFE BULLOCK,		
	Vice-President			Trust Officer
FRANK C. NICHOLS,		ELMER F. SEABURY,		
	Vice-President			Asst. Treasurer
SAML. M. NICHOLSON,		HARRY C. OWEN,		
	Vice-President			Asst. Secretary
WARD E. SMITH,		HENRY C. JACKSON,		
	Treasurer			Asst. Secretary

Directors

Joshua M. Addeman	Samuel P. Colt, Chairman	Frank C. Nichols
James M. Scott	James R. MacColl	Erling C. Ostby
H. Martin Brown	Harold J. Gross	John S. Holbrook
J. Milton Payne	R. Livingston Beeckman	Edward H. Rathbun
Eben N. Littlefield	Walter S. Ballou	Henry A. Hoffman
Ezra Dixon	Albert H. Sayles	Alfred M. Coats
Lyman B. Goff	Henry W. Harvey	Frank L. Pierce
Samuel M. Nicholson	James M. Pendleton	Edward B. Aldrich
	Thomas P. Peckham	
	Everett I. Rogers	

UNITED STATES OF AMERICA

ATLANTIC CITY

TO THE

AMERICAN BANKERS ASSOCIATION

CONVENTION BOND

2631

SEPTEMBER TWENTY-FOURTH TO TWENTY-EIGHTH 1917

Know All Men By These Presents that the Citizens of Atlantic City, a municipal corporation of the State of New Jersey, acknowledge themselves indebted for value received and to be received from the visits past, present and future of the Members of the American Bankers Association, and hereby decree in consideration thereof to deliver to bearer five days of unalloyed rest, pleasure, health and plenty, from the twenty-fourth day of September to the twenty-eighth day of September, in the year, nineteen hundred and seventeen, on the presentation of the respective coupons hereto attached as they severally become due, both principal and interest of this bond being payable in good will of the Citizens of Atlantic City at any time and place within the limits of said City, at the option of the holder thereof. This bond is issued for the purpose of spreading the fame of Atlantic City and furnishing a souvenir to be shown to each and every friend of the folder and to set forth briefly to all readers several attractions, resorts, walks, climate, delights, amusements, fishing, golf, hospitality, individuality, joy, kindness, life-giving ozone, menus, hot-hair, ocean, promenade, quiet, rolling, dunes, sunbathing, beaches, unspoiled beach, variety, water, swimming, bathing, walking, golf, and culture, which are more particularly described and in greater detail set forth in the folder entitled Atlantic City, the Playground of the World, a copy of which may be obtained on application to the Atlantic City Directory Bureau. It is further certified, verified and declared that all the acts, conditions and things required to exist, happen and be performed precedent to and in the issuance of this bond have been duly performed and have developed in due time, form and manner as required by law, that this issue of bonds has been authorized by the unanimous desire of the men, women and children of said City, and that the value of this bond, together with the good wishes of all citizens of said City, is hereby guaranteed by any statute or law whatsoever. The full faith and credit of the said City and of Atlantic City are hereby irrevocably pledged for the punctual payments of the principal and interest of this bond.

We Witness Whereof, the said Citizens of Atlantic City have caused this bond to be signed by their Board and Commercial Organizations and attested by the corporate seal of The Public City Bureau hereto attached, and this bond to be dated the twenty-fourth day of September 1917.

Chas. Brown
Jack Simpson
David Coates
Rev. P. M. Inghett
John H. Thompson

ATLANTIC CITY PUBLISHING HOUSE
 1908

Richard M. Coates
John H. Thompson
Wm. H. Houston
John H. Thompson
Lansut Co.

AMERICAN BANKERS ASSOCIATION
ATLANTIC CITY
 SEPTEMBER 24TH-28TH 1917
YACHTING PARTY
 FROM 10:00 AM TO 5:00 PM
 THE REGATTA, HELD AT THE BEACH
 MONDAY AFTERNOON AT 3 O'CLOCK
 FREE TO ALL

AMERICAN BANKERS ASSOCIATION
ATLANTIC CITY
 SEPTEMBER 24TH-28TH 1917
RECEPTION
 BY NEW JERSEY STATE BANKERS
 ASSOCIATION
 AT THE WHEEL REST
 MONDAY EVENING AT 8 O'CLOCK
 DANCING AND CONVERSATION

AMERICAN BANKERS ASSOCIATION
ATLANTIC CITY
 SEPTEMBER 24TH-28TH 1917
TANGO CONTEST
 FIVE HUNDRED DOLLAR PRIZE
 7:00 PM
 2100 AVENUE DANFORTH

A Coupon Bond That Was Paid in Full

The Bankers Service Corporation

of New York

Offers to client Banks a Service based on experience and measured by results—for the increasing of deposits.

We would welcome the opportunity of pointing out to you some truly remarkable records of growth resulting from plans devised and executed by us.

Bankers Service Corporation

258 Broadway, New York

The Blackstone Canal National Bank

Providence, R. I.

IN BUSINESS SINCE 1831

ALBERT R. PLANT
President

HERBERT F. HINCKLEY
Vice-President

CHARLES P. BROWN
Cashier

We have unequalled facilities for collecting Bill of Lading Drafts, which are at the service of our Customers. Write us about this service.

Resources over Four Million Dollars

Worcester Bank & Trust Company

Worcester, Mass.

WILLIAM D. LUEY, Chairman of the Board

JOHN E. WHITE, President

HENRY P. MURRAY, Vice-President

SAMUEL D. SPURR, Vice-President

SAMUEL H. CLARY, Vice-Pres. & Trust Officer

MERRILL S. JUNE, Asst. Trust Officer

ALVIN J. DANIELS, Treasurer

BERTICE F. SAWYER, Secretary

FREDERICK M. HEDDEN, Cashier

WALTER M. HUNT, Asst. Cashier

CHARLES F. HUNT, Auditor

Commercial Department, Assets over \$22,000,000
Trust Department, Assets over . 5,000,000
Capital 1,250,000
Surplus and Undivided Profits over . 650,000

Largest Commercial Bank in Massachusetts Outside of Boston

This war is going to mean to our nation a rebirth. All business and industry is going to be raised to a higher standard. Every patriot who participates in this great work of social and political reconstruction is a civic soldier of democracy. Every citizen who fails to participate in this patriotic movement is a slacker and a parasite.

W. G. P. Harding, Governor Federal Reserve Board:

The capital of the state bank and trust company members of the Federal Reserve system amounts to more than \$61,000,000, their surplus to more than \$62,000,000, and their total resources to more than \$1,200,-

that is true, it must always be remembered that America entered the war for a more immediate reason. Noble and idealistic as is her championship of universal democracy, she entered this war primarily because of the persistent insults and aggressions of Germany, the wanton disregard of American rights within our own borders as well as upon the high seas, the contemptuous violation of international law and the ruthless destruction of American life and property.

James B. Forgan, chairman of Board, First National Bank, Chicago:

As to the practical working of clearing house examinations in Chicago during the



The Traymore — Atlantic City's Largest and Finest Hotel, and the Meeting-Place of Several Sections of the Convention

000,000, and new applications for membership are being received every day from small banks as well as large.

I am confident that in two weeks more the resources of the state member banks and trust companies will amount to more than \$2,000,000,000, and I cannot but feel that if the state banks and trust companies of America will give earnest consideration to the contingencies ahead of us, motives of self-interest, as well as a patriotic desire to cooperate, will determine them to apply for membership, and that within six months the number of state bank members will be nearer eighty-four hundred than eighty-four.

Secretary McAdoo:

It has been repeatedly stated that America entered this war to make liberty and democracy secure throughout the world. While

eleven years of their existence I can only say that it has proved in every way most satisfactory and successful. There has been neither friction nor unpleasantness. Bank directors realize the great benefits derived and are unstinted in their praise of them. They are greatly assisted by the examiner's reports in keeping themselves informed on the condition of their banks and they readily cooperate with the clearing-house committee in the correction or elimination of anything open to criticism. Our experience has been that the banks have almost unanimously adopted every suggestion made by the committee. I cannot, of course, discuss such details as would show its efficacy. I can only say that the results have been most satisfactory to all concerned and that much good has been accomplished for the Chicago banks individually and collectively.

THE
Merchants National Bank
PROVIDENCE, R. I.

Capital, - - - \$1,000,000
Surplus Earnings, \$1,000,000
Resources, - - - \$11,000,000

ROBERT W. TAFT, President
CHARLES H. NEWELL, Vice-President
MOSES J. BARBER, Vice-President and Cashier
FRANK A. GREENE, Assistant Cashier

Collections on this city handled with care and
remitted for at reasonable rates



The
**Providence
National
Bank**

ESTABLISHED 1791

PROVIDENCE, R. I.

The Oldest Bank in New England

WE RECEIVE local and out-of-town Accounts of
Corporations, Firms and Individuals

Correspondence Solicited

WILLIAM GAMMELL
PRESIDENT

WILLIAM GAMMELL, JR.
VICE-PRESIDENT

EARL G. BATTY
CASHIER

Capital, Surplus and Profits \$1,400,000

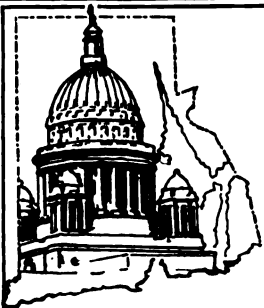

Why "Hospital" is in Our Name

Bankers in different sections of the country often ask why the word "Hospital" occurs in our corporate name. When this company was chartered (1867) one of its objects was to aid the Rhode Island Hospital. A part of the annual profits went to the support of that institution. Later this arrangement was changed, so that the Hospital received outright a block of the Company's stock. The word "Hospital" remains in the name of the Company, a significant reminder of our honorable historic connection. We are proud of our name and are trying to live up to its spirit, not only in our local business, but also in serving our broader clientele of banks and bankers.

Rhode Island Hospital Trust Company

PROVIDENCE, R. I.

W. D. Vincent, vice-president Old National Bank, Spokane, Wash.:

Five million dollars can be saved in the advertising expense of the clearing-house banks of this country if a committee is appointed in each association made up of the men who attend to the advertising of each bank. Experience has taught bank advertising men that newspapers and financial journals are the best mediums for bank advertising. Competition has led bank men into advertising in cook books. Cooperation among banks through their committees on advertising will produce better advertising, more business and a large reduction in the amount spent to secure these results.



VARIOUS NOTES

Many thanks to the weather man. He could not have done better.

Some of the bankers were too dignified to try the "Fun Factory," but a lot of them weren't.

In his report Chairman Oliver J. Sands, of the executive committee of the National Bank Section, paid a deserved tribute to the late W. H. Bucholz, vice-

president of the Omaha National Bank—one of the knightliest men that ever filled a bank executive's chair.

Chicago, which gets most of the good things going—and deserves them—gets the next convention.

"They say" that at some of the get-together dinners there were several of the big bankers who cut capers just like school boys.

Tango contests, cake-walks, fun factories—such are the innocent amusements in which bankers indulge when away from home.

Why not have popular sessions of the conventions to which all the people would be welcome whether bankers or not? Try this at Chicago.

Atlantic City is a real convention town—a fact probably not startlingly new to anybody who has ever been there.

That oasis in the desert of former conventions—the California headquarters—was sadly missed this year.



Which makes the better executor?

A great-american woman, inexperienced in business affairs or a Trust Company, whose able officials are experienced in handling hundreds of estates?

The Georgia laws provide that if you should leave no will, your wife would probably be appointed administratrix of your estate. Or if you do not have a wife surviving, your mother might be appointed.

Is it fair to women who have had little or no business training, to put into their hands the management of property which is perhaps the only source of their income?

You can be sure that their interests will be properly cared for, by having your lawyer carefully prepare a will, appointing the Atlanta Trust Company executor or trustee of your estate.

ATLANTA TRUST COMPANY
140 Peachtree Street



How one man is fulfilling his duty to home and country



NINE patriotic and thoughtful forefathers for family may be read between the lines in one of our Trust Department records.

A young business man made up his mind to drive an ambulance in France, and before he left he turned his whole fortune into Liberty Bonds. He then made a trust agreement with us, under which we have taken over the entire management of these investments.

Each month we are to send a certain sum to his mother and sisters, to maintain them in the comfort to which they have been used.

The rest of his income is to be placed in his bank account, on which he can draw drafts either while abroad or when in this country. When the young man comes home he may at once take charge of his affairs, if he wishes.

If the care of your family and your property interests between you and your services to your country, come in and talk to our Trust Department officers. We may be able to show you how we can relieve you and your dependents of all worry about the management of your financial affairs.

BANKERS TRUST COMPANY

Resources over \$330,000,000

16 Wall Street

Fifth Ave. at 42nd St.

As for banks "Fidelity Trust Agencies"

Our officers give personal attention to customers

One of the distinguishing features of The FIDELITY'S superior service is the personal attention given by our officers to the individual banking and trust problems of customers. The officers are all easily approached, always glad to see you. You do not have to wait but in hand, outside closed doors, in order to see them. There is only a low railing, with several open gates, between them and the public.

You are invited to come in and talk over with our officers any matters connected with your business or your trusts in which The FIDELITY can possibly be of service.

FIDELITY TRUST COMPANY
Charles and Lexington Streets



Pay Roll Accounts

MANUFACTURERS and other large employers of labor will find the services of the First National valuable in connection with the making up of their pay rolls. We have made more or less of a specialty of this work, and do it for quite a number of our depositors.

This is one of many ways in which we strive to give constructive service to our customers. Others are: Our encouragement of trade acceptance, our efficient collection work, and our monthly ledger posting and statement system.

FIRST NATIONAL BANK
—IN BROOKLYN
BRADWAY & HAYWARD ST.



General Thrift will win this war

England's first war loan had only 100,000 subscribers, in the latest one there were over 8,000,000.

The reason was that, in the meantime, the war had been brought home to England.

Our country will have a similar experience. We will have to save before the war is over. Why not begin to do it now and help America to end the war quickly?

FIRST TRUST & SAVINGS BANK
Lombard & W. Center—Beverly

Advertisements

prepared by

EDWIN BIRD WILSON
Incorporated

Financial Advertising

Bankers Trust Building

New York



"Carry On"

That is the motto of our Canadian allies and it will not be long before our own boys will be "carrying on."

If you are about to depart on military service and are leaving important business and money matters behind, let this strong trust company carry on your interests in accordance with your instructions.

Rhode Island Hospital Trust Company



Our Twin Watchwords—Safety and Service

At the FIRST service is second only to safety.

We are ready and willing to give all of our customers the best in the way of service. We will extend to a depositor every accommodation to which he is entitled on the basis of his standing and balance.

FIRST TRUST & SAVINGS BANK
Lombard & W. Center—Beverly



Will you disregard one of your highest duties?

DOUBTLESS you are now meeting fully the responsibilities you assumed in establishing a family. But have you provided for every contingency, so that the support of your wife and children will be assured?

You can provide for your heirs by carefully planning your will, having it prepared by a competent attorney, and by appointing Mercantile Trust Company of San Francisco as executor and trustee.

Our officers will be glad to talk over with you this important matter.

MERCANTILE TRUST COMPANY
OF SAN FRANCISCO
464 CALIFORNIA STREET



To Somewhere in Europe on "A.B.A." Cheques

For many years "A.B.A." Cheques, like the "magic carpet" of Arabian Nights' fame, have been carrying American safety and comfort to Europe and other countries on routes of pleasure and business. Now, these Cheques are carrying Americans to Europe on another kind of ground—fighting for the safety of American democracy and world democracy.

"A.B.A." Cheques can be used in any country where military plans may take our fighting men, because they are international in character and do not have to be converted into the currency of any foreign country by the United States and Canada through the six main offices in the United Kingdom and Bank relations in the seven principal, strategic and important financial centers and in ten. Think what a saving in transportation! How, in dollars and other currencies, this will mean to the

American army and navy men in Europe. The officers of both sides of the front are enjoying themselves with these Cheques as a matter of course. How can they have the comfort of the bank and the bank and the bank? How can they have the comfort of the bank and the bank and the bank?

Get them at your bank, or write Bankers Trust Company, New York, for booklet and information as to where they may be had in your country.



Somewhere in France

you may soon be doing your bit for the freedom of the world. You have been called to the colors and are leaving behind you

Somewhere in Maryland

dependents and property interests requiring care and oversight in your absence. The Union Trust Company is fully authorized and equipped to act as your financial agent, deputy or trustee, and is especially glad to act in such capacities for those who expect to go on duty overseas.



UNION TRUST COMPANY
Baltimore

"Eats" were not so plentiful as at Boston. The intellectual town, after all, provided the most material food. But nobody appeared to be suffering from hunger at Atlantic City.

Woodrow Wilson's presidential boom began to make headway after his address to the bankers at Denver in 1908. Will history repeat itself in the case of Dr. Nicholas Murray Butler?

*President's Liberty Loan Proclamation
Calling On the Nation for Subscriptions*

BY THE PRESIDENT OF THE UNITED STATES OF AMERICA
A PROCLAMATION

The second Liberty Loan gives the people of the United States an opportunity to lend their funds to their Government to sustain their country at war. The might of the United States is being mobilized and organized to strike a mortal blow at autocracy in defense of outraged American rights and of the cause of liberty. Billions of dollars are required to arm, feed, and clothe the brave men who are going forth to fight our country's battles and to assist the nations with whom we are making common cause against a common foe. To subscribe to the Liberty Loan is to perform a service of patriotism.

Now, therefore, I, Woodrow Wilson, President of the United States of America, do appoint Wednesday, the 24th of October, as Liberty Day, and urge and advise the people to assemble in their respective communities and pledge to one another and to the Government that represents them the fullest measure of financial support. On the afternoon of that day I request that patriotic meetings be held in every city, town, and hamlet throughout the land, under the general direction of the Secretary of the Treasury and the immediate direction of the Liberty Loan Committees which have been organized by the Federal Reserve Banks.

The people responded nobly to the call of the first Liberty Loan with an oversubscription of more than 50 per cent. Let the response to the second loan be even greater, and let the amount be so large that it will serve as an assurance of unequalled support to hearten the men who are to face the fire of battle for us. Let the result be so impressive and emphatic that it will echo throughout the empire of our enemy as an index of what America intends to do to bring this war to a victorious conclusion.

For the purpose of participating in Liberty Day celebrations all employees of the Federal Government throughout the country whose services can be spared may be excused at 12 o'clock Wednesday, the 24th of October.

In witness whereof, I have hereunto set my hand and caused the seal of the United States to be affixed.

Done in the District of Columbia, this 12th day of October, in the year of our Lord, one thousand nine hundred and seventeen, and of the independence of the United States of America the one hundred and forty-second.

WOODROW WILSON.

By the President.

(Signed)—ROBERT LANSING,
Secretary of State.



UNION *National Bank* OF CLEVELAND

In our new building with modern equipment we are better prepared to render good service to our friends.

*"Expedition Service now—
Long Experience taught Us How"*

WARREN S. HAYDEN, Chairman of the Board

GEORGE A. COULTON, President

WILLIAM E. WARD, Vice-President

ELMER E. CRESWELL, Vice-President

WALTER C. SAUNDERS, Cashier

FRED. W. COOK, Asst. Cashier

CARL F. MEAD, Asst. Cashier

HARRY E. HILLS, Asst. Cashier

FRANK A. WHITE, Asst. Cashier

DO YOU KNOW

that the first National Bank chartered in the United States was the First National Bank of Philadelphia? We are still doing business at 315 Chestnut Street and invite accounts of banks, firms, corporations, partnerships and individuals on terms commensurate with the character of the account.

OFFICERS

Wm. A. Law, President

Kenton Warne, Vice-President

Freas B. Snyder, Vice-President

Harry J. Haas, Vice-President

Thos. W. Andrew, Cashier

Chas. H. James, Asst. Cashier

Carl H. Chaffee, Asst. Cashier

Total Resources - \$41,000,000

THE FIRST NATIONAL BANK

PHILADELPHIA, PA.

THE BANKERS MAGAZINE

ELMER H. YOUNGMAN, *Editor*

SEVENTY-FIRST YEAR

NOVEMBER 1917

VOLUME XCV, NO. 5

Advertising to Make Loans

IN the January issue of *THE BANKERS MAGAZINE*, discussing the subject of "Buying and Selling in Banking," the question was raised as to the propriety of advertising the lending facilities of banks. It was pointed out that practically all of the advertising done by banks consisted of invitations for more deposits; that is, the banks asked the people to lend to them, but said nothing about their ability and readiness to lend to others. In the article referred to, this question was put:

"Is not the credit which a banker has to sell just as proper a subject for advertising as the carrots or turnips which the grocer has to sell?"

Considerable pleasure is felt in seeing the inquiry then raised affirmatively answered in practical fashion by the Guaranty Trust Company of New York. Here is the offer, which appeared in the New York newspapers of October 11:

"In order to facilitate subscriptions to the Liberty Loan, this company stands ready to make loans to its patrons for use in the purchase of these bonds. In the judgment of this company, it is necessary for everyone to subscribe not only to the extent of his surplus funds but also to use a generous portion of his borrowing ability in anticipation of future savings. We are prepared to coöperate in this patriotic service by extending liberal credit to our depositors and customers. Under present money market conditions, we will make such loans at four per cent."

This is a most significant banking development, coming from the largest trust company in the world, and located in a city of conservative banking traditions. Nor is the significance of this an-

nouncement lessened by the fact that this offer to lend its credit is for the patriotic purpose of buying Liberty Bonds. It is also patriotic to buy state, city, county, township and school district bonds, and it is patriotic to borrow for the purpose of engaging in legitimate business of any kind.

The fact is that banking traditions are bending to the needs of the times. When you hear the leading bankers of the United States urging rediscounting, and saying that there must be expansion of credit, you realize the truth of this statement.

Since the foregoing was written banks have quite generally indicated their readiness to make loans to those wishing to buy Liberty Bonds.

HOW WILL THE BANKS FARE UNDER PRESENT CONDITIONS?

THIS is an inquiry which many banks are making just now, and the answer is by no means easy. If one should ask, "Will the banks lose deposits?" reply could confidently be made in the negative, for it is inconceivable that the vast activity in business, the heavy expenditures on Government account, and the rise in prices will not be represented by larger bank deposits.

But while most bankers understand all this well enough, what many of them are concerned about is how each individual bank may fare. As a practical business man the banker is compelled to ask, "How will my own bank be affected by the great changes now taking place?"

So long as this country was merely furnishing supplies to the other nations engaged in war, this question did not arise. But now that we have become involved in the war, with the Government competing with the banks for the people's money, the case is different.

Should the depositors of a particular bank withdraw funds from that bank for the purpose of buying Government bonds, it would reduce the deposits of the bank, at least for the time being unless the bank happened to be a Government depository, in which case there would be simply a transfer on the books. But even in this case, the Government would gradually withdraw the funds, and

whether they would come back to the bank would depend upon two factors—the ability of the community where this bank was located to furnish supplies the Government needs, and the ability of the bank in question to hold its own in competition with the others in its locality.

Speaking generally, the banking condition, while it may be temporarily disturbed, will gradually tend toward an equilibrium; or, in plainer words, the money taken out of a community or a bank will come back again. The stream of banking funds, like the waters of the sea, constantly arises to refresh the unquenchable thirst of trade, only to return again to its source, the process being interminably repeated.

The Government is buying from the East manufactured articles of all sorts, but it is likewise buying food from the West and South. In the long run, each community will get about the share of the funds which its ability to furnish the needed supplies warrants, and each bank will get the share which its safety, service and energy warrant.

Canada and most of the European countries from which statistics are available show gains in savings deposits since the war began, and it is hardly probable that the banks of the United States will have a different experience.

But there is danger that some of the banks will lose deposits unless they display more than their customary energy. Undoubtedly the great changes taking place in many lines of business will result in considerable shifting of bank accounts, and in this process the energetic institution will make the best showing.

Looking at the present situation from the standpoint of individual bank advantage, it would seem that the live bank can not only hold its own but that it ought to make material gains in its business.

SMALLER BANK BILLS

AT the recent session of Congress a measure was passed which will permit national banks to issue their circulating notes in denominations of one dollar and two dollars, the smallest denomination heretofore existing being \$5, and notes of this denomi-

nation were restricted to one-third of the total circulation of each bank. Briefly, the new law authorizes the banks to issue their notes in denominations of one dollar and two dollars to the amount of \$25,000, and other notes in such denominations as they may wish.

It was apparently at one time an axiom of banking—or rather of currency—that the smaller denominations of circulating medium should be made up of actual coin, and this principle was well illustrated by the restriction of Bank of England notes to denominations no smaller than £5; but the various expedients that have been recently employed in banking and finance have upset many long-cherished traditions.

In this country coin—except of a subsidiary character—has practically disappeared from circulation—not because of the war, but simply for the reason that the people generally prefer paper. The demand for bills of small denominations indicates great business activity, and has been accentuated by the fall trade.

THE BANKER AND HIS CUSTOMER

CONVERSING with a banker in a small town, this thought was brought out:

“My customers,” said the banker, “do not like to be seen talking with a bank officer. They fear that other people who see them thus engaged will at once jump to the conclusion that they are asking for a loan. So the officers of our bank occupy private offices where they can not be seen by the public. Not infrequently people who apply for loans enter and depart by the rear door.”

What a gulf this reveals between the bank officer who has “favors” to dispense in the shape of credits and the customer who has “favors” to ask in the shape of loans!

If our country banker is correct in his appraisal of the feeling of timidity which possesses the applicant for a bank loan, it must be that the seeker for bank credit considers himself about on a par with the man who enters a pawnshop with his wife’s wedding ring.

Perhaps this exaggerates the matter somewhat, but undoubtedly the person who asks for credit at a bank, at least until he gets

accustomed to the process, does feel awed as in the presence of superior power.

It is really a case of putting the cart before the horse. Whatever may be the standing of an individual depositor or borrower, in the aggregate they are much stronger than the bank itself. The bank depends more upon them than they do upon the bank.

Are the banks desirous of keeping the people in awe of them to the extent that the above statement would indicate? It is not believed that they have any such purpose. In fact, this barrier between banker and customer is gradually disappearing, and in the larger and more progressive banks it no longer exists. In such banks there is a realization that the banker and his customer are partners in the business of life—that the interests of one, in the long run, are those of the other.

There is no justification for the element of fear in the mind of any man who applies for a bank credit to which he is legitimately entitled, and the live banker certainly wishes his customers to entertain no such feelings, for he understands well enough that there must be no obstacles to the frankest and friendliest relations between the bank and those who deal with it.

TRUST COMPANIES ENTER FEDERAL RESERVE SYSTEM

FOLLOWING the recent entrance of the Guaranty Trust Company into the Federal Reserve System, other large New York trust companies have cast in their lot with the new system. These are the Equitable, Metropolitan, Bankers, Central and New York.

It is probable that other important trust companies will take similar action in the near future. Indeed, it would not be surprising if there would be a general movement on the part of state banks and trust companies into the Federal Reserve System.

The qualified degree of popularity which the system has heretofore attained among bankers has been due to the natural aversion which banks feel toward the new and untried. Then some of the

actions of the Federal Reserve Board, although undoubtedly well intended, were rather sweeping and suddenly upset established banking practices. Some of the earlier rulings have been modified, and this fact, combined with the gradual adaptability of the system developed in practice, makes the bankers more favorably disposed toward the Federal Reserve System than they were at first.

But at present the strongest incentive to membership on the part of state banks and trust companies consist in the patriotic impulse to afford the banking system of the country the greatest possible strength through unity. From their own standpoint, too, the banks doubtless realize that their position would be improved within the sheltering folds of the Federal Reserve System.

Should all the 30,000 banks of the United States enter the Federal Reserve System, the perfection of the system through needed legislation might be much easier than with the present limited membership. If all the banks should unite in a demand for some particular legislation, it would seem that their numbers and influence would carry great weight.



Interest on Deposits

THE Comptroller of the Currency has received a number of enquiries from national banks as to the expediency of raising the rate of interest on their deposits from three per cent to four per cent, so as to reduce the inconvenience which might arise from large withdrawals of deposits for investment in Liberty Bonds.

The Comptroller has sent out a circular letter in answer to these enquiries, which says, in part:

"This office considers four per cent. a decidedly high rate for national banks to allow on deposits under existing conditions. My suggestion is that you take no action towards raising the rate of interest until you are in a better position to determine exactly what the effect of the offering of the Liberty Bonds may be upon your deposits.

"If there should be large withdrawals of deposits for investment in Liberty Bonds and you should require funds to meet these withdrawals or to supply your customers for their legitimate business needs, these funds can readily be obtained from the Federal Reserve Bank of your district at favorable rates—at present from 3½ to 4½ per cent. per annum, and against the money so obtained from your Federal Reserve Bank you do not, of course, have to carry reserve as you do for deposits.

"Your attention is also called to the fact that the national banks generally have the opportunity of being designated as temporary depositaries for the purchase money of Liberty Bonds sold through each bank, although these particular funds will of course be withdrawn from time to time as the Government shall need the money."

Problems Relating to Financing Foreign Governments*

By HON. H. R. BRAND, M.C.G., Vice-Chairman British War Mission

WHEN I was asked by the American Bankers Association to give an address on the "Problems of Financing Foreign Governments," I was very glad to accept their invitation, mainly perhaps, because it afforded me an opportunity of giving some account of what Great Britain has been able to do in the direction of financing her Allies since the beginning of the war. In view of the close relations now existing between the two great sections of the English-speaking world, nothing in my view is more important than that we should each understand what the other is doing, and has done, and, if anyone has an opportunity to assist in this work, it is their duty in my opinion to seize it.

For three years the burden of financing the Allies has to a large extent rested on Great Britain. So far as we can continue to finance them by granting them credit in Great Britain, we are going on doing so, but, as far as the United States is concerned, the burden has now been passed into your hands.

You are now being called upon in the general interest of the allied cause to lend huge sums to all the different Allies, and there is no more valuable support towards winning the war that could possibly be given. It may be, therefore, that our experience may be in some respects useful to you.

I shall not of course presume to discuss either the financial or economic situation in the United States, because that is not the province of an Englishman, nor do I possess any knowledge which would enable me to talk about such a subject to a meeting of American bankers. What I propose to do

is to discuss certain aspects of the very large question under consideration by giving some account of what has happened in England financially and economically since the beginning of the war. You can understand that I can only deal in the very broadest outlines, but it may be as I say, that the problems we have had to face may be of some value to you.

Although I am in this country in the service of the British Government, I am concerned with the supply of munitions and not here on behalf of the British Treasury. You must therefore consider my remarks as unofficial. My personal qualifications for addressing you on this subject are that in ordinary life I have been for some years engaged in the profession of international banking and finance, and that for the last two years I have been intimately connected on behalf of the British Government with the supply of munitions both from England and Canada, and have come much into contact with the large financial questions arising therefrom, and also with the measures taken by the government to control industry.

BRITISH WAR EXPENDITURES

I am not going to deal with the subject of this address simply by giving you a mass of figures, or by discussing the purely financial side of the question, for the problems connected with financing one's Allies, not only touch the financial side of a nation's life, but go down deep into its economic and industrial life, and cannot be properly understood except in relation to it.

* Address before National Bank Section, American Bankers Association, Atlantic City, September 26, 1917.

Nevertheless, as a preliminary it may be well to give a few figures about England's war expenditure:

Our total national expenditure from August 4, 1914, to August 4, 1917, may be put approximately at \$25,080,000,000. This expenditure has been provided as to \$6,087,000,000 out of revenue, and as to \$18,993,000,000 by an increase in our national debt. Since the amount we have lent our Allies is recoverable, the figure of \$18,993,000,000 given as the increase to our national debt, must be reduced by so much. If we deduct this figure from \$18,993,000, the increase in our national debt is \$13,295,000,000, which added to the pre-war \$3,165,000,000, makes a total of \$16,460,000,000.

Our actual daily expenditure since April 1 last, including loans to our Allies, has been at the rate of about \$35,000,000 a day. Our irrevocable expenditure has averaged about \$22,000,000 a day. Our increase in revenue, owing to increased taxation, has been very great. Before the war we raised roughly \$1,000,000,000 a year. This year we have budgeted for \$3,100,000,000, and probably we shall get between \$3,150,000,000 and \$3,400,000,000. Taxation to this extent would have been thought three years ago to have been wholly impossible.

These figures will serve to show you the extent of the burden on a nation only half as populous as the United States. If population is taken as a basis, our daily gross expenditure is equal to an expenditure in this country of about \$70,000,000 a day.

I may mention that in our last war loan we raised \$5,000,000,000 of new money, which, again on the basis of population, would be equivalent to your raising here in one financial operation \$10,000,000,000. Now, what do these figures mean? What efforts on our part have been necessary? What measures had we to take and what problems to solve to enable us to find the money we required ourselves, and also to lend these huge sums to our Allies? To be able to answer these questions, it is necessary to get some picture of the effect

of the war on England's general economic life.

FINANCIAL ABILITY OF NATIONS

Perhaps the greatest surprise of the war to most people, even to those who had studied political economy, has been the enormous expenditure of money which a nation can incur, and the length of time which it can go on fighting without complete exhaustion. This should not have been in reality a surprise to anyone who had studied past history, for all experience shows that "money" itself has never prevented a nation from continuing to fight, if it were determined to fight. The financial condition of Revolutionary France at the commencement of Napoleon's career was wretched in the extreme, yet France went on fighting for nearly twenty years after that. The Balkan States can hardly be said ever to have had great financial resources, and yet they fought, one after the other, two severe wars, and are now fighting a third still more severe and prolonged. The Boers in South Africa found no difficulty in fighting the British Empire for three years with practically no financial resources. The Mexicans recently managed to fight one another for a good many years in the same way. Lastly, the Southern States in your own Civil War fought for years a desperate and losing fight, and were ultimately beaten to the ground, not so much by a lack of money, as by an actual lack of things to live on and fight with. In fact all history proves, and this war proves to us over again, that if what the Germans call "the will to fight" exists, money will never stop a nation's fighting, provided only it possesses or can obtain its absolute minimum requirements of food, clothing and munitions of war. It was Bismarck, I think, who said: "If you will give me a printing press, I will find you the money." No doubt in finding the money required for an exhausting war, a nation is driven to all sorts of desperate financial expedients which may very seriously affect its economic life, but in my opinion if a nation wants to continue fighting and can produce or be

induced to produce, the things that are absolutely necessary for life and warfare, the Government will get hold of those things somehow. If it cannot get them in any other way, ultimately it will take them.

Therefore, though the mechanism of finance is exceedingly important, the vital thing both for a country itself and its Allies, is that it should produce and so have available everything required for war, both for itself and for them. This may seem an elementary fact, but I lay stress on it because it is to my mind fundamental and the key to the actions of a government at war. If the goods are not there or cannot be obtained from other countries in some way or other, no method of financing will avail at all. The all important thing is therefore the annual production of the people for war, and the amount of that production which is left over after satisfying civil consumption and which is available for the war needs of the nation itself or its Allies. In other words, the all important thing is that the government should assist in the development of the maximum productive capacity of the nation, should direct that productive capacity into channels suitable for war, and should restrict entirely the consumption of luxuries, and as far as possible, of everything else required by the ordinary civil population.

It was some time in England before we saw how to achieve these results. We started with "business as usual." We thought we could go on as in peace time, but we soon found that was absolutely impossible. To put industry on a war footing so that the nation should produce what is required for a war and as much of it as possible, required drastic measures on the part of our government.

Perhaps the simplest way of explaining why such measures were required is to try and give some idea of our national production and consumption in normal times and show how it has been affected by the war. Most figures of national production and consumption are unreliable, but the English figures, though somewhat out of date, happen to be fairly reliable, as they are the

result of a searching investigation by a royal commission on the census of production some years ago. The figures I give are for the year 1907. No doubt by the year 1914 they had been very much increased and have changed still more since, but they will serve as an illustration of my argument:

In 1907 the British people are estimated to have produced goods to the total amount of, roughly.	\$10,000,000,000
The nation consumed during that year in personal consumption	7,050,000,000
It spent on capital purposes at home:	
(a) On betterment of its national plant.	950,000,000
(b) On maintenance of its national plant.	900,000,000
It used up goods to the value of (in keeping up and probably increasing its stocks of material on hand) . . .	325,000,000
It exported goods in the form of loans to foreign countries of about	500,000,000

making up in all the \$10,000,000,000 that it actually produced. By 1914, probably its income had increased to at least \$12,500,000,000 and the surplus of goods which it had over to export as loans to foreign countries seems to have increased from about \$500,000,000 to \$1,000,000,000.

FINANCIAL AND ECONOMIC CHANGES

What happens then in war time? First of all there was an enormous and growing demand for materials of all kinds for war consumption, either in the form of guns, or shells or military clothing, or food or motor trucks, or aeroplanes or any of the hundred and one items of military equipment, and not only for ourselves but for our Allies.

How was that demand met? It is

obvious from the figures given above, that there must be great changes either in production or consumption, or there would be no materials at all for war purposes, because they are normally all used up in other directions, and in fact seven-tenths of what we produced in the year 1907 was immediately consumed again in the form of personal consumption by the people. It is clear we must either have increased our production of goods or reduced our consumption, or lastly, bought more goods from foreign countries by selling them our liquid capital assets.

Let us consider first how we can have reduced our consumption. It must have been in one or all, no doubt all of the following ways:

1. By cutting off altogether our normal peace loans to foreign countries, i. e., in 1914, \$1,000,000,000.

2. By cutting down all normal additions to our national plant, i. e., by building no more houses, factories, railways, roads, etc., except for purely war purposes. This expenditure in 1907 amounted to about \$950,000,000.

3. By cutting down and ceasing as far as possible to spend money on the maintenance of our national plant, except the minimum required to keep it running. This expenditure in 1907 amounted to \$900,000,000. We have undoubtedly let our roads, railways, houses and so forth, to some extent deteriorate.

4. And most important of all, by cutting down our civil personal expenditure. This is so far the largest item of consumption, that it is here where the most important savings can be made.

By these means it is obvious that at the expense of our becoming poorer and allowing our national plant, our railways, houses, factories, etc., to deteriorate and by strict personal economies we have been able to turn a large volume of production in the direction of war material, in other words, to devote the labor and material formerly used for the above purposes purely to war purposes.

But how about production? Has it decreased or increased? The greatest productive capacity in a nation is to be found, of course, among the men who are of fighting age. In England, the total number of "occupied males" between the ages of 18 and 44, i. e., roughly, the conscription age, was in 1911, 7,200,000. The number of men from the United Kingdom in our army and navy amount to over 5,000,000; therefore, out of every seven of these men, on the average five are now soldiers or sailors. These men are lost from the productive capacity of the nation. It is obvious that if our production has remained the same, or has increased, it must have been the result of extraordinary efforts on the part of the small percentage of occupied males of fighting age left, on the part of all the other males, occupied or formerly occupied, and on the part of all females.

Notwithstanding the great difficulties, I think it is probable that our production is quite as great as before. Measured in money, and owing to the rise of prices, it would probably be much greater. This is due to the fact that the whole population practically speaking has been working, and working intensely. Millions of women who have not worked before are working now. No one is idle. Every acre of land or garden that can be used is being used. Methods of production have been speeded up, labor saving machinery in industry and agriculture multiplied. In every direction the wheels have been turning faster.

But, perhaps, more important still, the *character* of our production has entirely changed—almost our entire industry is producing for war purposes. Ordinary civil needs are no longer considered. We have of course to produce what is essential for life, but beyond that, all our energies are directed to war production. The Government has of necessity compelled the whole of British industry to produce for war and to produce what it is told to produce, because in no other way could our own armies and our Allies have been supplied. No man is free to do what he likes with his

labor and capital, with his ships or with his steel. He has to do what he is told to do. By this means, production for war purposes has enormously increased, and civil consumption too enormously decreased, because the goods for the civil population were no longer produced, and you cannot buy what isn't there. Instead of gramophones, the Gramophone Company makes fuses; instead of cloth for ordinary clothes, the woolen factory makes khaki; instead of motor cars the motor-car maker makes shells.

Apart from selling our liquid capital assets in return for foreign goods, and apart from borrowing from foreign countries for the same purpose, our power to provide our own army and navy with all they want and have any surplus over for our Allies, has indeed depended entirely on our extraordinary efforts in production, and not in normal production, but in war production, and also on the extent to which we have been able to reduce our civil consumption of all kinds. I put production first, because while economy in consumption is exceedingly important, increased productive capacity devoted to war material in my opinion, is still more important. Our increased productivity has, as I say, been devoted entirely to war requirements. We have had to turn over our whole industry from a peace to a war basis. We have both voluntarily and compulsorily cut off the production of goods which are unnecessary for war purposes. Many trades have been actually shut down and the labor taken from them and handed over to war industries. Labor itself has been subjected to restrictions which would have been wholly impossible before the war. Labor may not leave its employment without government leave; salaries and wages may not be increased without government approval. Measures for the control of industry which were unheard of, and, in fact, absolutely impossible before the war, have been imposed upon all industry. Fixed prices have been placed on the most important materials. The government now has the absolute control of the use of steel,

copper, lead, wool, leather and other materials for which the war demand is insatiable, and also of all materials manufactured therefrom. No use may be made of most of these materials for any purpose whatever, without a certificate being first obtained. No buildings of any kind may be erected without leave of the Ministry of Munitions. I may mention a personal experience that may bring home to you perhaps the position. A short time ago a sister of mine, who lives in the country, ran short of water because her pump broke down. She was informed that no material could be used to mend it without a certificate from the Minister of Munitions. I heard of the matter because she wrote to me to invoke my help. This may show you the extent of the control now exercised. The whole of the industry may be said now to be directed to the government. Its regulation is an enormous task. In the head office of the Ministry of Munitions alone, there are more than 10,000 people.

On the other side, partly as result of the goods required actually not being produced, and partly as result of restriction, either compulsory or voluntary, of consumption, we have cut down enormously our ordinary consumption of luxuries, and are now cutting down on necessities. Both for financial reasons, and owing to the pressure on tonnage caused by the submarine, the government has for long instituted an extremely drastic restriction of imports. I regret myself that these restrictions were not introduced earlier, and here is something in our experience which may be useful to the United States. We discovered to our surprise at the beginning of the war that war apparently meant prosperity and not poverty. The huge governmental expenditures and the loans and taxation which they caused resulted in an enormous redistribution of wealth. Wages advanced, and millions found that they had more money than they had ever had before. The result was that consumption actually tended to go up among the poorer classes, and labor and materials vitally required for war purposes were di-

verted to meeting these new demands. It was some time before our government realized the disastrous nature of this tendency, and it was long before the whole of the people realized that though an individual may be able to afford to be a spendthrift in war time, a nation cannot afford that he shall be. But, of course, nearly all our extravagance in this respect is now long over. So far as our own efforts and sacrifices make the export to our Allies of war materials from our own resources possible, we are, I believe, doing all that we humanly can.

DECREASED CONSUMPTION

There has been an enormous decreased consumption of many foodstuffs, and also of other materials. Personal expenditure on servants, motor cars, clothes and everything else, has been cut down. I will give two examples. When I left England some months ago no private owner of a motor car could get more than ten gallons of gasoline a month. Our ration of sugar is twenty-five pounds per head per annum now; American consumption per head in 1916 was seventy-five pounds. If you reduced your consumption to ours, you would on that item alone make a saving of about \$100,000,000 per annum.

Perhaps I can bring the situation clearly before you by the following comparison: Before the war, we imported for the needs of our civil population, about 55,000,000 tons of materials of all kinds each year. We are now importing about 30,000,000 tons. Of that 30,000,000, at least 10,000,000 represent munitions of war of one kind and another for our Allies as well as ourselves. The balance of 20,000,000 tons is in the main foodstuffs. Therefore, as against 55,000,000 tons before, we are now getting 20,000,000 nearly all of foodstuffs. But let me show you how immense is the burden of increased prices to an importing country like England, and what increased wealth is pouring into an exporting country like the United States. For our imports in 1913, approximately 55,000,000 tons, we paid \$3,209,000,000; for our 20,-

000,000 tons, we are paying at the rate of between \$3,900,000,000 and \$4,350,000,000. That is the effect of wheat at \$2.20 instead of 80 cents and cotton at 20 cents instead of 10 cents. And that \$3,900,000,000 is paid for by the export of real wealth from us or by the raising of debts we must repay.

You may think that all my insistence on our increased production and increased economy in consumption has not much bearing on the problem of financing our Allies. But in reality, it has the most direct and vital bearing, and your experience in this respect will be the same as ours. We have never once, I believe, refused an Ally the necessary credit if we have been able consistently with our own demands to supply them with the goods which they wanted from our own home products. We continue now to grant them the necessary credit, when we can make the goods ourselves in Great Britain. But the problem has been to find the labor and material to produce what they wanted as well as what we wanted. We have as a matter of fact supplied them with every variety of materials in enormous quantities. We have lent them continuously hundreds of ships at cost price, the most valuable commodity in the world. We have supplied them with coal, steel in very large quantities, with guns, rifles, ammunition, explosives, and every other kind of munitions, motor trucks, rails, railway materials, locomotives and so on. In the year 1916 alone we supplied them in addition to the materials quoted above, which are of course the most important for war purposes, with 9,000,000 pairs of boots, over 100,000,000 sand bags, 40,000,000 yards of jute, millions of socks and blankets, and in addition, several thousand tons of leather; also cloth, foodstuffs of every kind, portable houses, tools, hospital equipment and so forth.

We have been able to do this and to continue doing it first of all because our whole industry is now devoted to war purposes, secondly, because of our intensified productive energy, and thirdly, because of our economy in civil consumption. Without these efforts we

might have been prepared to give our Allies the same amount of credit, but that would have been useless, because the goods they wanted would not have been there.

We have had, however, to assist our Allies, not only by supplying them with what we could produce internally, but by enabling them to purchase abroad. This has been a problem of extreme difficulty, and of a character different from any that is likely to face the United States. And it is here that we have had to supplement our resources by the means I have already mentioned, namely, the sale of every liquid asset our government could lay its hands on.

We are, as you know, by no means a self-contained nation. With all our efforts we have not been able to produce all that we or our Allies have required. The demands of war are absolutely insatiable, and we have neither been able to produce the kinds of things which were required, nor have we had enough of what we could produce ourselves. Copper, for instance, we had to buy from you, and where, as in the case of steel we produced largely ourselves, so unlimited have been our own and our Allies' demands, that there also we had to buy largely from you. At home our supply to our Allies of all articles has been limited only by our productive capacity and our economy, and not by any lack of credit. Abroad it has been limited by our means of payment and by the credit we have been able to secure.

LENDING CREDIT AT HOME AND ABROAD

I need hardly tell an assembly of bankers how fundamentally different are the problems of lending one's Allies credit at home and lending them one's credit in foreign countries. I started my address by pointing out that in some way or other a government at war has always raised and will always raise credit enough to get hold of the goods that its people produce in wartime. Look to-day, for instance, at such comparatively poor countries financially as Russia, Austria-Hungary and Turkey. These governments have been able

to find credit and create currency sufficient to continue the fight. But the problems before a government of procuring the goods produced by other countries is a wholly different one, and depends entirely on whether that government has anything of intrinsic value to the foreign nation to give in return, or, if it has not, whether it can induce that foreign nation to sell goods on credit.

Now England, at the commencement of the war, was in far the strongest position of any of the Allies to purchase munitions and other materials from foreign countries both for herself and her Allies. She was in fact the greatest creditor nation in the world. France, too, was a powerful creditor nation, but not so powerful as England, and at the commencement of the war her export commerce received, unfortunately, a much more staggering blow than England. While therefore, France has made every possible effort financially, the greater burden fell to us. On the other hand Russia and Italy were debtor nations, and even before the war had to borrow in order to balance their foreign account. Serbia was, of course, in the same position, and Belgium has been in that position since the commencement of the war too. All these nations have required assistance in making purchases abroad. From the commencement of the war, therefore, we have had to assist our Allies and also our Dominions as well, in making foreign purchases. As I have already stated, we have in these three years lent not less than six billion dollars, at home and abroad, to our Allies. I have discussed the methods we adopted to lend them our credit in our country. It is necessary now to consider very briefly how we have found the means to lend them our credit in foreign countries.

Consider England's position in 1913 as regards her balance of trade. In that year her imports were valued at \$3,210,000,000, her exports at \$2,560,000,000. But it has usually been estimated that England was owed about \$1,610,000,000 annually by foreign countries for interest on capital lent, for shipping,

freights, and for banking, insurance, and other commissions, etc. If this sum is added to her exports, then the total amount owed to her was \$4,170,000,000 as against \$3,210,000,000 which she owed for her imports. In other words, she had a favorable balance of about \$960,000,000, which was lent abroad. She was, therefore, in a very comfortable position. The war, however, has altered that position greatly to her disadvantage.

It is true, as I have already pointed out, that the tonnage of our ordinary commercial imports has been enormously reduced, and has constantly been falling off since the commencement of the war. But so has the tonnage of our exports, although the huge increase in prices has actually enormously increased the value of our imports and maintained that of our exports at nearly their pre-war figure. Our export trade must in fact have been enormously reduced in tonnage, because it is mostly to South America and the far East and in order to provide tonnage nearer home, all our ships have been taken by the government off these routes, and brought to the North Atlantic. But the excess of commercial imports over exports is now about \$1,950,000,000 a year instead of \$630,000,000, altogether apart from our huge government imports.

It is impossible to say to what extent our earnings from freights, interest and commissions have been affected by the war, but unquestionably they have not covered anything like the above extremely large debit balance. In consequence we have been obliged for very many months to take exceptional measures to maintain our exchange with this country, from whom our chief purchases are made.

In fact, these unfavorable influences of the war began to tell very soon on our external position. Notwithstanding our drawing in, in the first months of the war, money which we had lying all over the world, which I believe amounted to a very large sum, and notwithstanding our great exports of gold, there was by June, 1915, a collapse in our

American exchange, and it was clear that much more drastic measures to maintain it were required. These measures could only be the mobilization of all our liquid assets salable abroad, and since that date it may be said that we have carried through completely this mobilization and placed those assets at the disposal of our Allies, so far as they were not needed to pay our debts.

In the first place, you have received in gold over \$1,000,000,000 since August, 1914, of which the major portion must have been from the British Empire.

In the second place, we have taken the most drastic measures to insure that every holder of American securities, or indeed, any other securities which we could sell or borrow against here, should either sell or lend such securities to the government. We have in fact I think drained our country dry of them.

I should not like to hazard a guess as to the value of American securities exported here both by the government and private persons, but they may amount to between \$2,000,000,000 or \$2,500,000,000, or even more. We have in fact taken every possible step to sell you everything you will buy.

EXCHANGE BETWEEN NEW YORK AND LONDON

While the exchanges between the Allies and nearly all neutral countries are depreciated, the exchange between New York and London has by means of the above measures been maintained practically at gold point to the very great advantage, not only of Great Britain, but of our Allies, and also of the United States, and in fact of every nation, except our enemies, because all are interested in uninterrupted trade.

In peace time the exchanges find their own level. If a nation is living too extravagantly, the fall in its exchange will naturally tend to correct its extravagance, because imports tend to be restricted and exports to be encouraged. Naturally, if the exchanges are artificially maintained, that tendency ceases to operate. That is of course a disad-

vantage, but it would be more of a disadvantage if it were not that other and even stronger influences are restricting ordinary commercial imports into European belligerent countries.

I have already quoted the very striking figures of the tonnage of imports into Great Britain, which sufficiently prove that practically no imports are now being made, except such as are absolutely necessary. Of course no nation could permanently tolerate such unfavorable trade balances as those from which the Allies in Europe are now suffering. They can only do so now and keep their exchanges with the United States steady by borrowing immense sums here. But the war itself is not permanent, and the question is whether the present state of affairs can be continued long enough to enable all the enemies of the Central Powers to exert their full strength and win a final victory. It seems to me that the true way to consider this question is this: Taken together, the resources of all the nations fighting the Central Powers are, or should be, adequate for all war needs and indeed almost unlimited. Since we all wish to win the war we must all wish them utilized to the full extent. That involves the best possible coöperation between all the Allies, and it involves too those Allies which have the goods lending them on credit to those which have not and which need them. Since in my opinion there can never be any question but that all the Allies in Europe are absolutely good for any external debts they may incur, there is every reason why if we can extend credit to one another, we should do so. Speaking of my own country, I believe she will surprise the world when the war is over with the rapidity with which she will repay her foreign obligations. Her productive capacity is unimpaired, and indeed increased; she will possess enormous foreign capital investments, not unfortunately liquid enough to form valuable security for raising loans abroad, but which will continue to return her large sums in interest. Undoubtedly she will have to live economically, but that ought to have become

an ingrained habit if the war goes on much longer. Indeed I consider that in the case of any great European power the repudiation of foreign obligations is inconceivable. The nation, which lends its credit, is therefore building up a capital investment abroad of undoubted value. That capital investment has already in the case both of England and the United States, reached enormous proportions. But there is this difference. Against what we have lent our Allies we have to set the capital assets we have sold and the debts we have incurred abroad. What we have lent out of our savings is small. But you have nothing to set against your loans. They have been done out of your savings and you have become a gigantic creditor nation instead of being a debtor one. Every nation has had to buy vast quantities of materials from the United States at enormously enhanced prices, and hitherto in the last three years while France, Russia, Italy and Great Britain have been becoming poorer, the United States have become enormously richer. Your government in return is now coming to the assistance of the Allies in the most generous manner by lending to all the Allies vast sums. It is only by so doing, as I said above, that the joint resources of all the countries fighting Germany can be made available in the most effective manner. Unless credit is so extended, either the materials cannot be used or the exchanges are bound to collapse, and trade for a while come to a standstill and be to a great extent permanently dislocated. The more speedily a great American army can be landed in France, the nearer will peace be. But meanwhile it is vital that the armies of France and Britain, which are now doing the fighting, should be maintained at their maximum strength and efficiency, and for this, they must have large supplies from this country.

LARGE CREDITS TO GREAT BRITAIN

You will no doubt all have noticed that the credits granted Great Britain have been greater than those granted to any other Ally. The reasons are sim-

ple, though they are not, I think, generally understood. We have in the first place the largest war and munition programme of any Ally; in the second place, as I have shown above, we are, with the exception of the United States, the greatest industrial arsenal among the Allies; that necessarily involves large imports. We send a great deal of steel from England to our Allies; we have to replace it by steel from here. We make rifles for Russia; we have to import the steel to make them. We send boots to Russia; we have to import the leather needed. These examples might be multiplied many times. Thirdly, we extend large credits in England to our Allies, some part of which they may use anywhere in the world, and this part may ultimately come back on the sterling exchange in New York. Lastly, it is well known that neutrals who are owed money by England unfortunately find it convenient to utilize the sterling exchange in New York in order to recoup themselves in dollars. But so also do neutrals who are owed money by the other Allies. So long as we maintain the sterling exchange this appears to be inevitable, and the burden of financing both our own and our Allies' trade tends to fall on that exchange. It is by our maintenance of this sterling exchange that this continuance of our Allies' trade is rendered possible. The maintenance of the sterling exchange is the maintenance of the allied exchanges. All these factors together exert an immense influence. If England had had only herself to finance since the beginning of the war, and indeed even if she had only herself to finance now, it is quite possible she would not have needed to borrow at all abroad.

I have now completed my very broad sketch of England's efforts in financing her Allies and the manner in which she accomplished the task. Let me summarize it:

England had two kinds of resources only—

1. Her liquid assets, namely, her gold and her salable foreign securities.

2. The excess of her productive capacity over her consumption on her own war and civil needs. It matters not whether the products she had in excess were such as she could lend direct to her Allies, or whether she lent materials obtained from abroad either in exchange for her own products exported or in return for past or present services, e. g., interest and freight.

Her liquid assets she has in the past three years nearly exhausted. She can in fact no longer create credit abroad for her Allies except by borrowing. She is limited therefore to her own productive capacity. She can and does continue to extend credit in England when she can provide the goods, but she must leave it for the United States to grant credit in America.

USE OF AMERICAN CREDIT

Lastly, I come to the question whether our experience has any bearing on your own situation. It is not my intention to discuss what your country ought or ought not to do. That would be a delicate matter for an Englishman to do in any case, and moreover I am not competent to discuss your problems or fully to understand your difficulties. I know quite well that you have many difficulties quite other than financial ones, which we do not have. I can see, too, the enormous task before your Treasury in raising the huge sums of money which have to be raised for yourselves and for the Allies, and the difficulties as regards your neutral exchanges, and as regards the export of gold, which may be involved by the export on credit of such masses of material to the Allies, while on the other hand you are obliged to pay for your imports. You may, too, think very properly, that when the United States is lending such huge sums to the Allies, it is superfluous for me to discuss this problem at all. One observation, however, you will perhaps allow me to make. It is one which my account of our experience naturally leads up to, and which in my opinion goes to the root of the problem. The credit which the

United States extends to the Allies is being used entirely, or almost entirely, in purchases in this country itself. Indeed in the main the materials must come from this country. You are the last great reservoir of supplies. There is nowhere else to go. In your case, therefore, even more than in ours, the fundamental problem lying behind the purely financial one, is the problem whether the materials which the Allies require are available over and above the supply of your own army and navy and your civil requirements. That is the problem which faced us. If I may judge from the newspapers, it already faces you. It will become more and more insistent because your own demands will be huge, and yet if we are not all to fail, it is vital that the French, British, Italian and Russian armies which are actually now fighting shall during the next year not go short of essentials to efficiency.

What are the chief materials required by the Allies? Food, steel, oil, copper, steel plates and so on. We hardly read of anything else in the papers but of the scarcity of these articles. Just like us, you are finding that you cannot produce and spend both for peace and for war at the same time. "Business as usual" is impossible. Business cannot be as usual. The ravenous demands of a modern war compel every nation at war to choose between peace and war; if they have elected for war, they must order their economic lives accordingly; they must turn their industry from a peace to a war basis, and they must see that every war demand has a prior claim to every peace demand. Circumstances, I fear, will compel you to re-

duce by all means in your power the unnecessary consumption of labor and materials. Let me, perhaps, give one example:

There are, I am told, 4,000,000 automobiles in this country, as against 800,000 in the rest of the world. No doubt the great majority of these are used for industrial and commercial purposes, but are there not a large number of private cars which possibly might be laid by for the period of the war, as now in England? Consider the labor and material, the steel, the copper, the aluminum, the rubber, etc., used in the production and in the repair of these cars; the gasoline used in running them, the labor absorbed in the drivers and the keepers of the garages, and you will have an example of the economies that are possible by the abstinence and sacrifices of the civil population in wartime. Similar examples can, of course, be found in every sphere of life.

Germany has shown above every nation hitherto what miracles enforced economy can perform. France and England are following fast in her footsteps. The measures we had to take were the restriction of all unnecessary imports, the cutting down of consumption by the civil population, the regulation of industry, so that it produced what was required for war before there was any thought of what was required for peace. We are told by the papers that food is short, steel is short, oil is short, and many other things are short. It seems, then, that these same problems which faced us face you. It may be that the measures we had to take may be the right ones in your case also.



An Item Out of the Day's Business

A COLORED man presenting his savings pass-book at the Lebanon County Trust Company for a withdrawal, was directed to the fact that his account appeared not to be growing

as it had been. This is how he explained it: "Well, you see, boss; I sure wants to keep up de good work, but it jes seems dat by de time I gets mah money spent, it's all gone."

The Case Against Germany

By HON. WILLIAM G. McADOO, Secretary of the Treasury

BEFORE this war broke out, every civilized nation accepted and honored the rule that in time of war a merchant vessel, neutral or belligerent, should not be sunk by an enemy war vessel unless the lives of the passengers and crew were first made safe. Under this long-observed law an American citizen had the right to travel upon a British or a French merchant ship with the full knowledge that that ship would not be sunk by a German war vessel until the passengers and crew were taken from the ship and their safety secured. Civilized warfare has always respected the lives of noncombatants.

If a German regiment should capture a French town or city, and, while marching through the streets, should fire upon a crowd of unarmed and helpless men, women, and children, killing a great number of them, crippling and wounding others, the whole world would gasp with horror; and yet this would be far less inhuman than to sink a ship at sea containing noncombatant men, women, and children, because on land those who are wounded may be rescued, taken to the hospitals and saved, while many who are not hit by bullets may actually escape. The reason the rule of the sea has always been rigidly enforced by every civilized nation is that if you sink an unarmed ship without giving the noncombatants a chance to escape, they are thrown into the water and all must perish. There is no chance for the wounded or the uninjured to escape. The remorseless sea engulfs them all and obliterates life "without a trace." What, therefore, would be a crime of the first order in the killing of noncombatants on land is a crime of colossal and inexcusable proportions when it is committed upon the high seas.

Yet this is exactly what Germany has done consistently since the outbreak of the war. She has destroyed merchant vessels on the high seas without warning, killing noncombatant men, women, and children without mercy and in the most brutal and ruthless fashion, in defiance of all international law and every accepted rule of humanity and civilization.

AMERICAN RIGHTS WANTONLY DISREGARDED

The rights of Americans upon the high seas have been wantonly disregarded. It is not an answer to say that Americans should not have sailed on merchant ships bearing the British or the French flag. They had a right to sail on those vessels, and were compelled to sail on them because there were not enough merchant ships under the American flag to furnish transportation for American business men, American consular and diplomatic officers, and others engaged in peaceful and rightful pursuits to go upon their legitimate errands. They were forced to sail under foreign flags and were entitled to the protection accorded by universally accepted international law and the mandates of civilization and humanity, viz.: that the ships would not be sunk by an enemy vessel until the safety of passengers and crew were first assured.

On September 1, 1915, the German Government gave the following assurance to the United States:

Liners will not be sunk by submarines without warning and without safety of the lives of noncombatants, provided that the liners do not try to escape or offer resistance.

This promise was promptly violated. On October 15, six weeks thereafter,

the steamship *Arabic* was sunk and three American lives were lost. The German Government said to the United States:

The Imperial German Government regrets and disavows the act and has notified Commander Schneider accordingly.

Scarcely had this assurance been received before the Italian steamer *Ancona* was torpedoed without warning, and seven American lives were destroyed. On the 29th of November, 1915, the American vessel *William P. Frye* was sunk in violation of international law. Following that, attacks were made upon several American vessels in gross violation of these promises, and on December 30 the British liner *Persia* was sunk in the Mediterranean without warning and more than 300 passengers and members of the crew were lost, among them being an American consul traveling to his post. This American consul was obliged to sail on this British vessel because there was no American vessel upon which he could travel. He was entitled to protection under international law, as well as under the repeated assurances of the German Government.

On January 7, 1916, the German Government again assured the United States that German submarines in the Mediterranean would not sink enemy merchant vessels, except in accordance with the general principles of international law, and "only after passengers and crews had been accorded safety." On February 16, 1916, the German Government said to the United States:

Germany has limited her submarine warfare because of her long-standing friendship with the United States, and because by the sinking of the *Lusitania*, which caused the death of citizens of the United States, the German retaliation affected neutrals, which was not the intention, as retaliation should be confined to enemy subjects.

The German Government promptly proceeded to disregard these assurances, sinking numerous ships without warning, injuring a number of American citizens, and imperiling the lives of many more. Whereupon the American Government notified the German Govern-

ment on the 18th of April, 1916, two months thereafter, that—

If it is still the purpose of the Imperial German Government to prosecute relentless and indiscriminate warfare against vessels of commerce by the use of submarines, without regard to what the Government of the United States must consider the sacred and indisputable rules of international law and the universally recognized dictates of humanity,



HON. WILLIAM G. McADOO
Secretary of the Treasury

the Government of the United States is at last forced to the conclusion that there is but one course it can pursue. Unless the Imperial Government should now immediately declare and effect an abandonment of its present methods of submarine warfare against passenger and freight carrying vessels, the Government of the United States can have no choice but to sever diplomatic relations with the German Empire altogether.

Whereupon the German Government, on the 4th of May, 1916, about two weeks thereafter, gave definite assurances to this Government that new orders had been issued to German naval officers "in accordance with the general

principles of visit and search in the destruction of merchant vessels recognized by international law."

Again, and in spite of these repeated assurances, the German Government proceeded to sink merchant vessels without warning and without securing the safety of the lives of passengers and crew. One American was killed on the British steamer Cabosha on October 20, 1916; eight Americans were killed on the British steamer Marina, October 28, 1916; seventeen Americans were killed on the British steamship Russia, December 14, 1916.

On January 31, 1917, the German Government gave this notice to take effect the following day:

Germany will meet the illegal measures of her enemies by forcibly preventing in a zone around Great Britain, France, Italy, and in the eastern Mediterranean, all navigation, that of neutrals included, from and to England, from and to France, etc. All ships met within that zone will be sunk.

Whereupon the United States on February 3, three days afterwards, severed diplomatic relations with the German Government in the following statement:

In view of this declaration which withdraws suddenly and without prior intimation the solemn assurance given in the Imperial Government's note of May 4, 1916, this Government has no alternative consistent with the dignity and honor of the United States but to take the course which it explicitly announced in its note of April 18, 1916, that it would take in the event that the Imperial Government did not declare and effect an abandonment of the methods of submarine warfare then employed and to which the Imperial Government now purposes again to resort.

All diplomatic relations between the United States and the German Empire were thereupon severed, the American ambassador at Berlin was immediately withdrawn, and the German ambassador, Von Bernstorff, was given his passports.

Between February 3 and April 1, 1917, almost two months, one American was killed on the British steamship Eavston, ten Americans were killed on the British steamer Vedamore, one American was killed on the British steamship Torino, one American was

killed on the French steamer Athas, eight Americans were killed on the British steamship Laconia, one American was killed on the British steamship Sjostad, five Americans were killed on the American steamship Vigilancia, seven Americans were killed on the American steamship Healdton, and nineteen Americans were killed or missing from the British steamship Crispin. Besides this, seven American steamships were sunk by German submarines in these two months, but no Americans, except five on the Vigilancia, were killed.

Moreover, the British steamer Yarowdale was captured by a German auxiliary cruiser prior to our entry into the war, and seventy-two American citizens were taken as prisoners of war by Germany, which was a clear violation of American rights. They were maltreated and abused and subsequently released.

GERMANY'S CROWNING ACT OF INFAMY

The crowning act of infamy in Germany's ruthless policy, however—and I mention it last, although it was the first in occurrence—was the sinking on May 7, 1915, of the British steamship Lusitania, an unarmed passenger vessel, and the killing of 114 American citizens—men, women, and children.

Each and every American life and each and every American vessel destroyed by Germany during these two years was an act of war upon the American people, the consequences of which were avoided from time to time by the plausible assurances and excuses of the German Government, each and every one of which was perfidiously and insincerely made, and each and every one of which was deliberately disregarded.

But this is not all. Germany, while professing friendship for America, and while her ambassador, her representatives, and her citizens were enjoying our hospitality and receiving our protection, was plotting against the domestic security of the United States by blowing up munitions plants, fomenting strikes and disturbances in the labor world, disseminating false information and poisoning the minds of the American

people against their own Government, plotting its downfall, and seeking to influence our Congress, as evidenced by Von Bernstorff's dispatch of January 22, 1917, to the Berlin foreign office, in which he said: "I request authority to pay up to \$50,000 in order, as on former occasions, to influence Congress through the organization you know of, which can perhaps prevent war." And while Von Bernstorff was busy upon our own shores with intrigue through his spy system and through the corrupt use of money to influence public opinion and the national policies of the American people, Zimmermann, the foreign secretary in Berlin, had sent a dispatch to Mexico urging her to make war upon the United States and begging Mexico to invite Japan to join her in this dastardly work, promising Mexico that California, Arizona, New Mexico, and Texas would be restored to Mexico in the event of success. What more perfidious conduct could have characterized the government of any nation with which we were at peace? What must be the judgment upon a government capable of such infamies? And yet there are those who undertake to defend Germany and to say that the American people did not have sufficient grounds upon which to enter this war!

The outrages committed upon American rights through the persistent destruction of American life and property during the years 1915, 1916 and 1917 were provocation enough, but when the German Government undertook by its edict of January 31, 1917, to mark off hundreds of miles of the high seas surrounding Great Britain, France, and Italy, and to declare that it would sink on sight every American vessel which entered these prohibited waters, although in pursuance of lawful commerce and of international right, and actually proceeded to carry out the threat, there was nothing left for America to do but to fight or else submit to this tyrannical and monstrous edict of the German military despot.

WHY WE CHOSE TO FIGHT

We chose to fight—and why? Because, first, national honor and self-re-

spect imperatively demanded it, and, second, because we can never concede the right of any nation, however powerful, to order American vessels and American citizens to keep off the high seas and prevent America from selling her surplus products of the farm, the factory, and the mine to other nations of the world.

If we had tamely submitted to that order, it would have brought disaster and ruin to the American people. Not only would it have been a mortal blow to their honor, self-respect, and standing as a nation, but it would have brought irreparable injury, loss, and suffering to our people. If any foreign nation in this war could with impunity order vessels of the United States to keep off of any portion of the high seas, which are the common property of all the nations of the earth, and if we had submitted, we would have established a fateful precedent. In a future war some other nation might conclude that American vessels carrying American citizens and American commerce should be ordered off of some other portion of the high seas, and we would be obliged to submit or to fight under all of the disadvantages of having yielded in the first instance. If we had been submissive, it would not be an illogical next step for the nation which ordered us off of 500 miles of the Atlantic Ocean to order us to keep off the entire Atlantic Ocean except that part within three miles from our own shores, over which we have acknowledged jurisdiction. We could never submit to such a destruction of our vital rights.

On the material side the disaster of submission is most striking. The Kaiser's order forbade our ships from carrying our people and our commerce to Great Britain, France, and Spain. Our prosperity and our welfare as a people are inseparably connected with our right of free and unmolested intercourse with those nations. In the fiscal year 1917 our total exports to Great Britain, France, and Italy were \$3,457,000,000, in round numbers; in 1916 they were \$2,247,000,000, in round numbers. Our exports to those countries consti-

tute more than one-half of our export trade with the entire world. These exports represent the surplus products of our farms, of our mines, of our factories. If we are denied a market for them, these farm products would rot or go to waste upon our own soil, the production of our mines and factories would be greatly reduced, labor would be thrown out of employment, stagnation of industry would result, and suffering and want would stalk in the land. Our production always has exceeded the home demand, and if we are denied foreign markets and attempt to sell the whole of our products at home, the result would be demoralized prices, with returns far below the cost of production, and consequent injury to every man, woman, and child in America. No one more than our farmers, the grain growers and the cotton growers particularly, would be so injured by obedience to the Kaiser's order. While our export trade would be destroyed, our import trade would disappear. Certain imports are essential to our national life and existence. We must have them, and we can never submit to any tyrant who forbids us to sail the high seas in the peaceful pursuit of our legitimate interests and in the unmolested enjoyment of the rights we won by the blood and courage of our ancestors.

If we had yielded to this insolent order signed by the Kaiser in his palace in Berlin, he would have destroyed by one stroke of his pen more than \$3,400,000,000 of our commerce, and American vessels and American citizens would have been excluded from all intercourse with the great and friendly nations of Great Britain, France, and Italy. By one stroke of the Kaiser's pen he would have accomplished more destruction on our farms, in our factories, and in our mines than he could achieve with all the armies and navies of the German Empire. It is a monstrous edict, and it would be a monstrous thing for America to submit to it.

And so we had to fight for our rights, and so it is that we engaged in a righteous war—a war which we intend to bring to a successful issue by the organized might of this Nation. We intend to match organization against organization, science against science, American skill against German skill, American valor against German valor, and I have not the shadow of a doubt that the victory will be complete, that America's honor will be vindicated, that America's vital rights will be preserved, that peace upon a stable and just basis will be re-established, and that democratic institutions will be extended throughout the earth.



Profitable Building

BANKS contemplating the erection of a new building will be interested in an article which appeared in the September number of "The Hoggson Magazine," entitled "Essentials of Profitable Building."

"The responsibility for the success of a building," says the article, "depends largely on an owner's personal judg-

ment. His is the initial decision to improve the property and, to quote the old couplet, 'well begun is half done.' The pitfalls ahead are both structural and economic. The former may be avoided by the choice of tried and experienced builders, but the latter must be studied and settled before the owner approaches the structural problem."

The War and the New America—The New Pan America

By **JOHN BARRETT**, Director General of the Pan American Union, the International Bureau of the American Republics, and former United States Minister to Argentina, Colombia and Panama

THE end of the war will be the beginning of a new era for Pan-America and Pan-Americanism. After the war will come a new America which will mean a new "all America," or Pan-America, and a new Pan-Americanism. In the crucible of this mighty struggle are being burned out the old animosity, the old distrust between North and South America. The purified residue will be a new mutual confidence, a new goodwill and a new coöperation for the common good. Pan-American comity and commerce, Pan-American travel and trade, Pan-American intercourse and intimacy will then have a new inspiration and a new force.

When the war is concluded we will realize that it has done more than any other international influence since the declaration of the Monroe Doctrine in 1823 to develop ideal and permanent Pan-American solidarity; that it has accomplished more than all the diplomatic notes of a century to make the Monroe Doctrine an unquestioned principle in the relationship of nations. After the war the Monroe Doctrine must and will become a great Pan-American doctrine. Then it will belong to, and be espoused by, every other American government from Canada, Cuba and Mexico south to Argentina, Uruguay and Chile, as much as by the United States. Then, being Pan-American and supported by every American government, it will be forever accepted and respected by the rest of the world—and, in its essence, become a world doctrine standing for the integrity, independence and self-government of every nation, great and small.

Victory for the United States and the Allies will remove for all time the only international menace to the Monroe Doctrine. The new Pan-America and new Pan-Americanism which will fol-



JOHN BARRETT

low the war will also be so powerful in their own inherent strength and backing that never again can a new menace from the old world assert itself.

OUR POSITION UNSELFISH

No other nation of America can honestly and logically even intimate that

the United States has entered this world struggle for any selfish purpose of territorial aggrandizement or for the slightest advantage over its sister American republics. No matter what doubts and discussions there may be concerning acts and wars of the past, there can be only one opinion throughout Pan-America concerning the attitude of the United States in its present course. Every man, woman and child from northern Canada to southern Chile knows absolutely in his heart that the United States is fighting for causes and principles just as dear to every South and Central American government, people and person as they are to the government, people and persons of the United States.

Every thoughtful statesman and commoner in every American nation must admit that victory for the enemies of the United States would mean the conquest and subjugation directly or indirectly not only of the United States but of the other countries of this hemisphere. It is, therefore, sublimely gratifying that the sober public sentiment of practically all the twenty Latin-American republics—eighty millions of people—is overwhelmingly pro-United States and pro-ally in this struggle of democracy against autocracy. It would seem, in consequence, to be only a question of time when all the Latin-American countries must follow the dictates and demands of this public sentiment and align themselves with the United States and the Allies. Otherwise, they may find themselves delaying and possibly preventing the triumph and supremacy of the basic principles which inspired them to fight for their independence and upon which they wrote their constitutions and constructed their nationalities.

There should be no hasty criticism of Argentina, of Chile, of Venezuela, of Colombia, of Ecuador, or of any other Latin-American government which may have not yet taken a decisive position in the present conflict. We must trust that each government is acting honestly and refuse to admit that influence and propaganda are holding these governments back in their final decision, just as we must decline to admit that such influence and propaganda kept the government of the United States for nearly three years, in the face of unspeakable irritation, from taking the final step.

On the other hand, let not any part of Pan-America blind itself and refuse to read the handwriting on the wall, which tells us that there is surely, even if slowly, rising an overpowering flood tide of public sympathy with the purposes, ideals and inspirations of the United States in this terrific fight of immortal right against mortal evil in the relations of nations. This flood, if the war continues another year, must inevitably sweep over all Latin-America from the Rio Grande to the Straits of Magellan, making even benevolent neutrality impossible.

Then, when the sun shall shine on that happy day, all America—Pan-America—shall, so to speak, form a choir of nations and peoples and chant in perfect unison a new hymn of Pan-Americanism, a new anthem of Pan-American coöperation and good-will confidence and commerce, progress and peace, which will be taken up by all the nations and peoples of the world and will herald the coming of the day when there shall begin everlasting peace and good-will among all men and all peoples throughout all time!



Banking and Commercial Law

LEADING CASES

Corporation Note

MASSACHUSETTS.

*Officer's Authority to Sign Check—
Holder in Due Course—Liability*

Supreme Judicial Court of Massachusetts,
May 25, 1917.

COLONIAL FUR RANCHING CO. VS. FIRST NATIONAL BANK OF BOSTON.

W., being officer of both S. Company and U. Company, gave S. Company's check to defendant bank in payment of a note of the U. Company held for collection, the check being certified by drawee trust company. The check was accepted in payment and the note delivered by defendant bank to maker's representative, and the check paid in due course. Held, that defendant bank, having no knowledge of want of authority in W. to sign check, and having no notice of any infirmity in the check, was not liable to S. Company or its assignee.

(116 N. E. Rep.)

Action by the Colonial Fur Ranching Company against the First National Bank of Boston. Case reported. Judgment for defendant.

STATEMENT OF FACT AND OPINION

Rugg, C. J. The salient facts in this case are that there had been sent to the defendant for collection a note made by the Union Commercial Paper Company, bearing also the personal indorsement of one Walker, its treasurer, and one Wing. The defendant sent notice to the Union Commercial Paper Company, maker, that the note had been forwarded to the defendant for collection. On its due date a representative of the maker presented to the defendant in payment of the note a check to the order of the defendant drawn by the St. Georges Bay Fur Company,

signed by said Walker, he being treasurer of that organization as well as of the Union Commercial Paper Company, on the International Trust Company and certified by the trust company. The check was accepted in payment and the note was delivered by the defendant to the representative of the maker. The St. Georges Bay Fur Company had a checking account with the International Trust Company. The check was paid in course and the defendant remitted the proceeds to its correspondent, who had forwarded to it the note for collection. There was no further evidence other than such inferences as may be drawn from these agreed facts. The defendant had no interest in the note or check other than as collecting agent. It had no knowledge whether the St. Georges Bay Fur Company, the drawer of the check, had any relations with the Union Commercial Paper Company, the maker of the note; nor did it have any knowledge as to the authority or want of authority of Walker as treasurer to sign the check, and no notice of any infirmity in the check unless necessarily inferable from the circumstances stated.

The plaintiff is the assignee of the St. Georges Bay Fur Company and brings this action to recover of the defendant the proceeds of the check collected by it. Its ground of action is that the transaction on its face showed that it was a payment of the private debt of Walker, for his benefit, out of the funds of the St. Georges Bay Fur Company without authority.

The plaintiff is not entitled to recover under these circumstances. The defendant bank, although named as payee of the check, was or might be, nevertheless, a holder in due course. Liberty Trust Co. vs. Tilton, 217 Mass. 462,

and cases there collected. By R. L. c. 73, § 76, every holder is deemed prima facie to be a holder in due course. The defendant became a holder in due course by receiving a check complete and regular on its face, before being overdue, in good faith and for value, with no notice of any infirmity in the check or defect in the title of the person negotiating it. R. L. c. 73, § 69. *Shawmut Nat. Bank vs. Manson*, 168 Mass. 425; *Boston Steel & Iron Co. vs. Steuer*, 183 Mass. 140. There is nothing in the agreed facts to indicate that the check was not given by its maker, the St. Georges Bay Fur Company, to the Union Commercial Paper Company in payment of a debt owed by it to the latter company, having been previously made at its request to the order of the defendant in order that the check might be used in payment of the note of the Union Commercial Paper Company held by the defendant for collection. Moreover, the check was certified by the trust company, on which it was drawn, before it was offered to the defendant. For aught that the latter knew, that certification may have been procured by the Union Commercial Paper Company, whose representative presented it to the defendant.

The check, complete in every respect as to form, was tendered to the defendant by a representative of the maker, the Union Commercial Paper Company, who was the one primarily liable on the note, and not by Walker, whose liability was only secondary. There was nothing in the transaction to indicate that the check was intended as a payment of the debt of Walker, but on the contrary everything indicated that it was intended as a payment of the debt of the maker of the note. In principle the case at bar is indistinguishable from *Nat. Investment & Security Co. vs. Corey*, 222 Mass. 453. See, also, *Allen vs. Puritan Trust Co.*, 211 Mass. 409.

The cases relied on by the plaintiff do not support its contention. In *Newburyport vs. Fidelity Mut. Ins. Co.*, 197 Mass. 596, 84 N. E. 111, the check of a municipality drawn by its treasurer to the order of his creditor was by him

handed to that creditor. Plainly that transaction bore on its face evidence of its infirmity. Here the primary debtor was not the treasurer, Walker, but the Union Commercial Paper Company, whose representative presented the check to the defendant and received the note from it. The facts that Walker was secondarily liable and was treasurer of both companies, and was not the person apparently active in the transaction, plainly distinguish this case in its essential facts from that case. The numerous cases from other jurisdictions relied on by the plaintiff, so far as applicable, are similar to *Newburyport vs. Fidelity Ins. Co.*, 197 Mass. 596, 84 N. E. 111, are not at variance with the conclusion here reached, and need not be reviewed in detail. There is nothing in *Johnson Co. vs. Longley Luncheon Co.*, 207 Mass. 52, which requires a finding for the plaintiff. The decision of *Farrington vs. So. Boston R. R.*, 150 Mass. 406, turned on the peculiar nature of certificates of stock in a corporation and did not involve the law of negotiable instruments.

In accordance with the terms of the report, let the entry be:

Judgment for defendant.
116 N. E. Rep. 731.



Clearing House Rules

NEW YORK.

Payment Through Clearing House.

Supreme Court, Trial Term, New York County, May 8, 1917.

FIRST NATIONAL BANK OF PHILADELPHIA VS.
NATIONAL PARK BANK OF NEW YORK.

Although the rules of a clearing house provided that drawee banks might return checks to the bank presenting them at any time before 3 p. m., a bank can only do so where it has at no time debited the amount of check against the account of drawer, and charging the account of the drawer with a check received through clearing house constituted an appropriation of the amount and a payment of the check, and entitled the payee to receive the proceeds, although the bookkeeper of the drawee bank,

after notice of suspension of drawer, erased the charge and transferred it to the credit column and returned the check to the bank presenting it before 3 p. m.

Action by the First National Bank of Philadelphia, Pa., against the National Park Bank of New York. Judgment for plaintiff.

STATEMENT OF FACT AND OPINION

Newburger, J. On July 21, 1916, the Mutual Trust Company of Orange, N. J., being indebted to the plaintiff, sent its check for the sum of \$18,231.66, which plaintiff forwarded to the Hanover National Bank, its correspondent in this city. On Monday morning, July 24, 1916, the Hanover National Bank sent the check, with other exchanges, to the New York Clearing House, where it was presented to the representative of the defendant bank; that, according to the custom in said clearing house, a balance was struck between the representatives of the Hanover Bank and the defendant, whereby it appeared that a large sum was due to the Hanover Bank, and that the check sued upon was included in the aggregate credited to the Hanover National Bank, and thereafter the packages containing the checks received by the defendant drawn upon it were opened and sorted and examined by clerks whose business it is to ascertain whether such checks are properly drawn and are in all respects items which the drawee bank is prepared to pay, and the drawee bank then had the privilege, under the provisions of the constitution of the clearing house, of returning any checks before 3 p. m. to the bank which had presented them through the clearing house.

The credit balance due to the Hanover National Bank on the 24th day of July, 1916, was paid by the defendant in accordance with the rules of the clearing house. A list was prepared of the items and totals of checks of each depositor, and this check, drawn by the Mutual Trust Company to the plaintiff, was included and then entered on a separate sheet under the name of the trust company and sent to the ledger

bookkeeper, who entered this total on the debit side of the account of the trust company. At the time of the entry on the ledger there was a sufficient credit balance to meet the check of \$18,231.66. It appears that the Mutual Trust Company, which opened for business on July 24, 1916, was closed shortly after 11 a. m. of that day by the Banking Department of New Jersey.

A telephone message to that effect was received by the defendant about half past 1, and at half past 2 the same was confirmed by letter, whereupon the cashier of the defendant directed the return of the check in suit to the Hanover National Bank, and subsequently the bookkeeper erased the entry on the letter and made a new entry of the check in suit as part of the credit balance of the trust company and not as a debit against it. It appears that while such erasure was made on the ledger, on the slip containing the itemized list of checks received by the defendant from the Hanover National Bank through the clearing house the item of \$18,231.66 was not erased. See plaintiff's Exhibit 1. The check in suit was returned to the Hanover National Bank and repayment claimed under the rules of the clearing house, which was made by said bank. The same afternoon plaintiff telegraphed a protest to the defendant, and later made a tender of the check and demanded payment of \$18,231.66, with interest, but payment was refused.

It is true that it has been repeatedly held that, under the rules of the Clearing House Association, the payment of balances by it is merely a tentative payment of items debited against any individual bank, and is not to be deemed complete until the debtor bank has had an opportunity to examine the items debited against it, and has, either by silence or affirmative act, approved of the debit, and until a drawee bank has actually accepted a check it may render such check not good by refusing to honor it and by returning it to the bank presenting it. See *Columbia Knickerbocker Trust Co. vs. Miller*, 156 App. Div. 810, affirmed 215 N. Y. 191; *Hentz vs. Nat. City Bank*, 159 App. Div. 743.

It will be noticed, however, that in these cases cited the courts, while holding that the drawee banks under the rules of the clearing house had the right to return the checks at any time before 3 o'clock, it could only do so where the bank had at no time debited the amount of the check against the account of the drawer. In this case the account of the Mutual Trust Company was charged with the check of \$18,231.66, and in doing so it constituted a payment of the check, and the mere physical act of the bookkeeper, after notice of the suspension of the trust company, of striking out the charge and transferring it to the credit column, did not deprive the plaintiff of the right that had accrued by reason of the charge that had been made against the debit account. By charging the account of the trust company with this check, the same has been paid, nothing more was left to be done, and the plaintiff was entitled to receive the proceeds of the check. As was said in *Nineteenth Ward Bank vs. South Weymouth Bank*, 184 Mass., at page 52, 67 N. E., at page 671:

"By those acts there had been set apart and appropriated to the payment of the note so much of the deposit then standing to the credit of the makers as was sufficient for that purpose."

As was said by Mr. Justice Miller in *Baldwins Bank vs. Smith*, 215 N. Y., at page 83, 109 N. E., at page 140, Ann. Cas. 1917A, 500:

"All that is necessary to constitute payment is the intention to make the application, which may be evidenced in a variety of ways, e. g., by bookkeeping entries, by canceling the note and surrendering it to the makers, by the drawing of a check by the makers and its acceptance in payment by the bank."

See, also, *Oddie vs. Nat. City Bank*, 45 N. Y. 735; *Am. Nat. Bank vs. Miller*, 229 U. S. 517. I am therefore of the opinion that the defendant recognized the validity of the check when it debited the check against the account of the drawer, the Mutual Trust Company

of Orange, and plaintiff is entitled to a judgment for \$18,231.66 and \$832.38 interest.

(165 N. Y. Supp. 15.)



Collateral Loan

PENNSYLVANIA

Collections—Negligence—Setoff

Supreme Court of Pennsylvania, January 8, 1917.

FARMERS' NAT. BANK OF BEAVER FALLS VS. NELSON.

A bank receiving commercial paper from a customer to be transmitted for collection is the customer's agent for transmission only, and not liable for negligence of its correspondents or agents, if it uses reasonable care in their selection.

Where commercial paper indorsed by the debtor is deposited with a bank as collateral security, the bank takes as pledgee, and obtains possession of the paper, and on maturity before payment of debt may enforce collection and apply the proceeds to the payment of the debt.

As one pledging collateral security to a bank has neither possession nor control of the collateral so as to present it or protest it, the bank as creditor and pledgee must take all necessary legal steps to preserve the collateral, and, if it is lost by its negligence, it is responsible to the debtor.

Action by the Farmers' National Bank of Beaver Falls against D. A. Nelson and David Knight. Verdict and judgment for defendants, and plaintiff appeals. Affirmed.

STATEMENT OF FACT AND OPINION

Mestrezat, J. This is an action of assumpsit on a promissory note for \$5,000, dated October 19, 1912, made by the defendants, D. A. Nelson and David Knight, and payable to the plaintiff bank four months and six days after date. It recites the deposit therewith, as collateral security, of the note of J. S. Hulings for a like sum, dated February 24, 1912, and payable one year after date. The latter note is payable to T. N. Barnsdall at the Second National Bank, Clarion, Pa., and is in-

dorsed by T. N. Barnsdall, P. J. Creighton, O. E. Aber, J. M. Friedman, D. A. Nelson, and David Knight.

The defense was that the note in suit was given to the bank in lieu of notes negotiated by it for O. E. Aber of like amount; that the collateral note was the only security the defendants had for the indebtedness incurred by them to the bank for Aber; that Barnsdall was perfectly good and responsible for the amount; that they notified the bank of these facts and requested it to be careful and take whatever steps were necessary in the collection of the note when it fell due; that notice of protest of the note for nonpayment was not given Barnsdall, who was thereby relieved from liability thereon; and that the failure of the plaintiff to take the necessary steps to preserve the value of the collateral note was an equitable satisfaction of the amount of the note in suit. The pleas were "payment, payment with leave, and set-off."

The defendants were indorsers on notes of O. T. Aber for \$5,000 which had been negotiated by the plaintiff bank, and these notes were lifted by defendants, and in lieu thereof they gave the note in suit with the Hulings note as collateral security. At the trial of the cause it appeared that the plaintiff sent the collateral note for collection to its reserve agent, the People's National Bank of Pittsburgh, and the latter forwarded the note to the First National Bank of Clarion, which presented it for payment at the Second National Bank of Clarion, and, being dishonored, it was protested for nonpayment. The certificate of protest shows that the notice for Barnsdall was mailed to him in care of the People's National Bank of Pittsburgh, Pa., that notice of protest was also mailed to the People's National Bank and to the Farmers' National Bank of Beaver Falls, Pa., the plaintiff. Notice of protest was mailed to all the other indorsers in care of the plaintiff bank, which mailed all these notices to the defendant Nelson. The notary testified that he received the addresses which he put on the certificate from the First National Bank of Clar-

ion. Barnsdall, who was corroborated by his employee, and was uncontradicted, testified that he never received any notice of protest. Aber testified that some time prior to the maturity of the collateral note he had given to the cashier and assistant cashier of the plaintiff bank the addresses of all the indorsers, that of Mr. Barnsdall being the Farmers' Bank building, Pittsburgh, where he had his office. Both officials of the bank contradicted Aber's testimony. Mr. Nelson testified that he told the cashier of the bank that the collateral note was good; that he and Knight had nothing but it as security for the note which they gave to the bank, and to be careful and take care of the note.

The learned trial judge instructed the jury that in transmitting the collateral note for collection the plaintiff was not liable for the negligence of any of its correspondents or subagents through whose hands the note passed, and that they were deemed the agents of the owners of the note for the purpose of presentation, payment, protest, and notice of dishonor; that the only material question for their consideration was whether the plaintiff bank was negligent in not sending with the notice for collection the correct business address of Barnsdall; that if Aber gave Barnsdall's proper address to the bank, and they believed that Nelson had cautioned the bank as to the necessity for collection from Barnsdall, and they found that the bank was negligent in failing to send Barnsdall's correct business address, then, if this negligence was the proximate cause of the failure to notify Barnsdall, the plaintiff bank was responsible for any loss thereby resulting to the defendants, and, if Barnsdall was financially able to pay the collateral note, the defendants were entitled to a set-off to the amount of the damages sustained, which would be the amount of the collateral note. It seems to be conceded, as the case was tried on the theory, that all the parties to the collateral note except Barnsdall were insolvent. There was a verdict and judgment for the defendants, and the plaintiff has appealed.

We think there is a clear distinction between the duty and liability of a bank when it receives commercial paper for collection and when the paper is deposited with it as collateral security for loan made by it to the owners of the collateral. While a different rule prevails in some other jurisdictions, we have uniformly held that a bank with which commercial paper is left by its customers to be transmitted for collection is the agent of the owners for transmission only and is not liable for the negligence or default of its correspondents or agents through whom it is necessary to transmit the paper, if it has used reasonable care and diligence in selecting such agents. In 1 Mechem on Agency (2d Ed.) section 1314, the learned author says:

"In the majority of the states * * * it is held that the liability of the home bank, in the absence of instructions or an agreement to the contrary, extends merely to the selection of a suitable and competent agent with proper instructions, and does not involve responsibility for the default or misconduct of the correspondent bank. * * * This rule is adopted in Pennsylvania."

The ground upon which this rule rests is that the contract of, or the duty assumed by, the home bank is to transmit, with proper instructions, the note or bill for collection to its correspondent bank, and the latter becomes the agent of the owner to make the collection, and is responsible to him for any loss occasioned by its neglect of duty. In *Mechanics' Bank of the City and County of Philadelphia vs. Earp*, 4 Rawle, 383, one of the earlier cases in this state dealing with the subject, bills were sent by a bank in Philadelphia to its correspondent in Virginia for collection, and, not being presented, were lost. In an action against the home bank the court said (4 Rawle, p. 386):

"The undertaking [of the bank] clearly was to transmit the bills, with the directions upon them, to their correspondent in Virginia. * * * The defendant [bank] was the agent for the

transmission of the bills, and their correspondent the agent for their collection."

In *Merchants' Nat. Bank of Philadelphia vs. Goodman*, 109 Pa. 422, 2 Atl. 687, 58 Am. Rep. 728, after citing cases holding the same doctrine, the court says:

"In our own state the principle has in several instances been maintained that a collecting bank is an agent for transmission to a subagent to collect, and when this is properly done, its duty is performed and its responsibility is at an end."

When, however, commercial paper is deposited with a bank as collateral security for payment of an indebtedness due the bank, with its debtor's indorsement upon it, the bank takes it as pledgee of the owner, and not merely for transmission for collection. The creditor or pledgee obtains possession and control of the paper, and, if it matures while the debtor's obligation remains unpaid, the creditor may enforce collection and apply the proceeds to the payment of his debt. The pledgor has neither the possession nor control of the collateral, and therefore is not in a position to present it for payment or acceptance, and, if dishonored, to have it protested. Hence it is clear, we think, that the creditor must take all necessary legal steps to preserve the collateral and if it is lost by his negligence he is responsible to his debtor.

"The holder of collateral security," says the court in *Muirhead vs. Kirkpatrick*, 21 Pa. 237, "was bound to preserve it [collateral] or collect it, and apply it for the benefit of the assignor. * * * His duties in respect to it are active. He is to employ reasonable diligence in collecting the money on the security, and applying it to the principal debt."

In delivering the opinion in *Hanna vs. Holton*, 78 Pa. 334, 337 (21 Am. Rep. 20), Mr. Justice Agnew said:

"He [the pledgee of collateral security] alone is empowered to receive the money to be paid upon it, and to

control it in order to protect his right under the assignment. This is the ground of the creditor's liability for the collateral. * * * It is therefore settled in this state that, where the collateral is lost * * * through the supine negligence of the creditor, he must account for the loss to his own debtor, who invested him with its entire control."

The same doctrine prevails in other jurisdictions. See note to *Miller vs. Gettysburg Bank*, 34 Am. Dec. 449.

It therefore being the duty of the creditor to protect the collateral for his debtor, we think it follows that the agent selected for the purpose by the creditor acts for him, and not for his debtor, and that for the negligence of his agent resulting in loss to the debtor the creditor is responsible. The debtor can exercise no control over the matter, and has no choice in selecting the agent. It would be a harsh rule which under such circumstances would relieve the creditor of the responsibility for the acts of his own agent and place it on the debtor. The duty of protecting the collateral resting upon the creditor, it is for him to meet it by himself or agents for whose acts he is responsible.

In the case in hand the failure to give notice of protest to Barnsdall was the negligent act of the plaintiff's agent, and therefore judgment was properly entered on the verdict for the defendant.

For the reasons stated, the judgment is affirmed.

(100 At. Rep. 136.)



National Banks As Trustees

U. S. SUPREME COURT

Power of National Bank to Act as Trustee, Etc., Under Federal Reserve Act.

United States Supreme Court, June 11, 1917.

FIRST NATIONAL BANK OF BAY CITY VS. GRANT FELLOWS, ET AL.

In error to the Supreme Court of the State of Michigan to review a judgment

which, in a proceeding in the nature of quo warranto, held that a national bank could not be clothed with power by the Federal Reserve Board to act as trustee, executor, administrator, or registrar of stocks and bonds. Reversed and remanded for further proceedings.

STATEMENT OF FACT AND OPINION

Mr. Chief Justice White delivered the opinion of the court:

We are of opinion that the procedure resorted to was appropriate and that the state court was competent to administer relief, but we postpone stating our reasons on the subject until the merits have been passed upon.

The court below held that an act of Congress conferring on national banks additional powers was in excess of the authority of Congress, and was hence repugnant to the Constitution. — *Mich.* —, 159 N. W. 335. The correctness of this conclusion is in substance the sole question for decision on the merits.

Although the powers given were new, the principles involved in the right to confer them were long since considered and defined in adjudged cases. We shall first consider the leading of such cases and then, after stating this case, determine whether they are controlling, causing the subject not to be open for original consideration.

In *McCulloch vs. Maryland*, 4 Wheat. 316, 4 L. ed. 579, the bank had been incorporated by Congress with powers to transact business of both a governmental and of a private character. The question which was decided was the authority of Congress to grant such charter. Without undertaking to restate the opinion of Mr. Chief Justice Marshall, it suffices for the purpose of the matter now before us to say that it was held that although Congress was not expressly given the power to confer the charter, authority to do so was to be implied as appropriate to carry out the powers expressly given. In reaching this conclusion it was further decided that to recognize the existence of the implied power was not at all in conflict with article I, section 8, clause 18 of the Constitution, providing that Congress

should have power "to make all laws which shall be necessary and proper for carrying into execution the foregoing powers," since that provision did not confine the implied authority to things which were indispensably necessary, but, on the contrary, gave legislative power to adopt every appropriate means to give effect to the powers expressly given. In terms it was pointed out that this broad authority was not stereotyped as of any particular time, but endured, thus furnishing a perpetual and living sanction to the legislative authority within the limits of a just discretion, enabling it to take into consideration the changing wants and demands of society and to adopt provisions appropriate to meet every situation which it was deemed required to be provided for. In fact, the rulings which we have stated were all summed up in the following passage, which ever since has been one of the principal tests by which to determine the scope of the implied power of Congress over subjects committed to its legislative authority:

"We admit, as all must admit, that the powers of the government are limited, and that its limits are not to be transcended. But we think the sound construction of the Constitution must allow to the national legislature that discretion, with respect to the means by which the powers it confers are to be carried into execution, which will enable that body to perform the high duties assigned to it, in the manner most beneficial to the people. Let the end be legitimate, let it be within the scope of the Constitution, and all means which are appropriate, which are plainly adapted to that end, which are not prohibited, but consist with the letter and spirit of the Constitution, are constitutional." P. 421.

In *Osborne vs. Bank, of United States, 9 Wheat. 738, 6 L. ed. 204*, where substantially the subject was presented in the same form in which it had been passed upon in *McCulloch vs. Maryland*, yielding to the request of counsel, the whole subject was re-examined and the previous doctrines restated and upheld. Considering more fully,

however, the question of the possession by the corporation of private powers associated with its public authority, and meeting the contention that the two were separable, and the one, the public power, should be treated as within, and the other, the private, as without, the implied power of Congress, it was expressly held that the authority of Congress was to be ascertained by considering the bank as an entity possessing the rights and powers conferred upon it, and that the lawful power to create the bank and give it the attributes which were deemed essential could not be rendered unavailing by detaching particular powers and considering them isolatedly, and thus destroy the efficacy of the bank as a national instrument. The ruling in effect was that although a particular character of business might not be, when isolatedly considered, within the implied power of Congress, if such business was appropriate or relevant to the banking business, the implied power was to be tested by the right to create the bank and the authority to attach to it that which was relevant, in the judgment of Congress, to make the business of the bank successful. It was said: "Congress was of opinion that these faculties were necessary, to enable the bank to perform the services which are exacted from it, and for which it was created. This was certainly a question proper for the consideration of the national legislature." P. 864.

As the doctrines thus announced have been reiterated in a multitude of judicial decisions, and have been undeviatingly applied in legislative, and enforced in administrative, action, we come at once to state the case before us to see whether such doctrines dispose, without more, as a mere question of authority, of the subject under consideration.

Section 11 (k) of the Act of Congress approved December 23, 1913, establishing the Federal Reserve Board (38 Stat. at L. 251, 262, Chap. 6, Comp. Stat. 1916, sections 9785, 9794), gives to that board authority "to grant by special permit to national banks applying therefor, when not in contravention of state or local law, the right to act

as trustee, executor, administrator, or registrar of stocks and bonds under such rules and regulations as the said board may prescribe."

The First National Bank of Bay City, having obtained the certificate required, began the exercise of the powers stated. Thereupon certain trust companies which, under the laws of Michigan, had the authority to do the same character of business, petitioned the attorney general of the state to test the right of the national bank to use the functions, on the ground that its doing so was contrary to the laws of the state of Michigan, and that the action of the Federal Reserve Board, purporting to give authority, was in contravention of the Constitution of the United States. The attorney general then, on the relation of the trust companies, commenced in the supreme court of the state a proceeding in the nature of quo warranto to test the right of the corporation to exercise the functions. The bank, in defense, fully stated its Federal charter, the rights given by the act of Congress, and the action of the Federal Reserve Board taken thereunder. The attorney general demurred to this defense, first, because Congress had no power to confer the authority which was called in question; second, because if it had the power, it was without right to delegate to the Reserve Board the determination of when it should be used; and third, because the exercise of the powers was in contravention of the laws and authority of the state, and the Reserve Board, therefore, under the act, had no power to grant the certificate.

The case was heard by the full court. In an opinion of one judge, which, it would seem, was written before the opinion of the court was prepared, it was elaborately reasoned that the exercise by a national bank of the functions enumerated in the section of the Act of Congress under consideration would be contrary to the laws of the state, and therefore the Reserve Board, under the terms of the Act of Congress, had no power to authorize their exertion. The opinion of the court, however, fully examining the grounds thus

stated and disagreeing with them, expressly decided that corporations were authorized by the state law to perform the functions in question, and that the mere fact that national banks were Federal corporations did not render them unfit to assume and perform such duties under the state law, because the mere difference existing between the general administrative rules governing national banks and state corporations afforded no ground for saying that it would be contrary to state law for national banks to exert the powers under consideration. The authority conferred by the Act of Congress and the rights arising from the certificate from such point of view were therefore upheld.

Looking at the subject, however, from a consideration of the legislative power of Congress in the light of the decisions in *McCulloch vs. Maryland* and *Osborn vs. Bank of United States*, and recognizing that it had been settled beyond dispute that Congress had power to organize banks and endow them with functions both of a public and private character, and in the assumed further light of the rule that every reasonable intendment must be indulged in in favor of the constitutionality of a legislative power exercised, it was yet decided that Congress had no authority to confer the powers embraced in the section of the act under consideration, and hence that the section was void. The court, following its reference to *McCulloch vs. Maryland* and *Osborn vs. Bank of United States*, and to passages in the opinions in those cases, upholding the rightful possession by the bank of both public functions and private banking attributes, stated the grounds which led it to conclude that the rulings in the decided cases were distinguishable and therefore not controlling. It said:

"But in the reasoning of the judges, in the opinions to which I have referred, I find, I think, a conclusive argument supporting the proposition that Congress has exceeded its constitutional powers in granting to banks the right to act as trustees, executors, and administrators. If for mere profit it can clothe this agency with the powers

enumerated, it can give it the rights of a trading corporation, or a transportation company, or both. There is, as Judge Marshall points out, a natural connection between the business of banking and the carrying on of Federal fiscal operations. There is none, apparently, between such operations and the business of settling estates, or acting as the trustee of bondholders. This being so, there is in the legislation a direct invasion of the sovereignty of the state which controls not only the devolution of estates of deceased persons and the conducting of private business within the state, but as well the creation of corporations and the qualifications and duties of such as may engage in the business of acting as trustees, executors, and administrators. Such an invasion I think the court may declare and may prevent by its order operating upon the offending agency." [— Mich. —, 159 N. W. 339.]

But we are of opinion that the doctrine thus announced not only was wholly inadequate to distinguish the case before us from the rulings in *McCulloch vs. Maryland* and *Osborn vs. Bank of United States*, but, on the contrary, directly conflicted with what was decided in those cases; that is to say, disregarded their authority so as to cause it to be our duty to reverse for the following reasons:

1. Because the opinion of the court, instead of testing the existence of the implied power to grant the particular function in question by considering the bank as created by Congress as an entity, with all the functions and attributes conferred upon it, rested the determination as to such power upon a separation of the particular functions from the other attributes and functions of the bank, and ascertained the existence of the implied authority to confer them by considering them as segregated; that is, by disregarding their relation to the bank as component parts of its operations,—a doctrine which, as we have seen, was in the most express terms held to be unsound in both of the cases.

2. Because while, in the premise to the reasoning, the right of Congress was

fully recognized to exercise its legislative judgment as to the necessity for creating the bank, including the scope and character of the public and private powers which should be given to it, in application the discretion of Congress was disregarded or set aside by exercising judicial discretion for the purpose of determining whether it was relevant or appropriate to give the bank the particular functions in question.

3. Because even under this mistaken view the conclusion that there was no ground for implying the power in Congress was erroneous because it was based on a mistaken standard, since, for the purpose of testing how far the functions in question which were conferred by the Act of Congress on the bank were relevant to its business, or had any relation to discrimination by state legislation against banks created by Congress, it considered not the actual situation, that is, the condition of the state legislation, but an imaginary or nonexisting condition; that is, the assumption that, so far as the state power was concerned, the particular functions were in the state enjoyed only by individuals or corporations not coming at all, actually or potentially, in competition with national banks. And the far-reaching effect of this error becomes manifest when it is borne in mind that, plainly, the particular functions enumerated in the statute were conferred upon national banks because of the fact that they were enjoyed as the result of state legislation, by state corporations, rivals in a greater or less degree of national banks.

4. In view of the express ruling that the enjoyment of the powers in question by the national bank would not be in contravention of the state law, it follows that the reference of the court below to the state authority over the particular subjects which the statute deals with must have proceeded upon the erroneous assumption that, because a particular function was subject to be regulated by the state law, therefore Congress was without power to give a national bank the right to carry on such functions. But if this be what the state-

ment signifies, the conflict between it and the rule settled in *McCulloch vs. Maryland* and *Osborn vs. Bank of United States* is manifest. What those cases established was that although a business was of a private nature and subject to state regulation, if it was of such a character as to cause it to be incidental to the successful discharge by a bank chartered by Congress of its public functions, it was competent for Congress to give the bank the power to exercise such private business in coöperation with or as part of its public authority. Manifestly this excluded the power of the state in such case, although it might possess in a general sense authority to regulate such business, to use that authority to prohibit such business from being united by Congress with the banking function, since to do so would be but the exertion of state authority to prohibit Congress from exerting a power which, under the Constitution, it had a right to exercise. From this it must also follow that even although a business be of such a character that it is not inherently considered susceptible of being included by Congress in the powers conferred on national banks, that rule would cease to apply if, by state law, state banking corporations, trust companies, or others which, by reason of their business, are rivals or quasi rivals of national banks, are permitted to carry on such business. This must be, since the state may not by legislation create a condition as to a particular business which would bring about actual or potential competition with the business of national banks, and at the same time deny the power of Congress to meet such created condition by legislation appropriate to avoid the injury which otherwise would be suffered by the national agency.

Of course, as the general subject of regulating the character of business just referred to is peculiarly within state administrative control, state regulations for the conduct of such business, if not discriminatory or so unreasonable as to justify the conclusion that they necessarily would so operate, would be controlling upon banks chartered by Con-

gress when they came, in virtue of authority conferred upon them by Congress, to exert such particular powers. And these considerations clearly were in the legislative mind when it enacted the statute in question. This result would seem to be plain when it is observed (a) that the statute authorizes the exertion of the particular functions by national banks when not in contravention of the state law; that is, where the right to perform them is expressly given by the state law; or, what is equivalent, is deducible from the state law because that law has given the functions to state banks or corporations whose business in a greater or less degree rivals that of national banks, thus engendering from the state law itself an implication of authority in Congress to do as to national banks that which the state law has done as to other corporations; and (b) that the statute subjects the right to exert the particular functions which it confers on national banks to the administrative authority of the Reserve Board, giving besides to that board power to adopt rules regulating the exercise of the functions conferred, thus affording the means of coördinating the functions when permitted to be discharged by national banks with the reasonable and nondiscriminating provisions of state law regulating their exercise as to state corporations,—the whole to the end that harmony and the concordant exercise of the national and state power might result.

Before passing to the question of procedure we think it necessary to do no more than say that a contention which was pressed in argument, and which it may be was indirectly referred to in the opinion of the court below, that the authority given by the section to the Reserve Board was void because conferring legislative power on that board, is so plainly adversely disposed of by many previous adjudications as to cause it to be necessary only to refer to them. *Marshall Field & Co. vs. Clark*, 143 U. S. 649, 36 L. ed. 294; *Buttfield vs. Stranahan*, 192 U. S. 470, 48 L. ed. 525; *United States vs. Grimaud*, 220 U. S. 506, 55 L. ed. 563, 31; *Monongahela*

Bridge Co. vs. United States, 216 U. S. 177, 54 L. ed. 435; *Intermountain Rate Cases (United States vs. Atchison, T. & S. F. R. Co.)* 234 U. S. 476, 58 L. ed. 1408.

The question of the competency of the procedure and the right to administer the remedy sought then remains. It involves a challenge of the right of the state attorney general to resort in a state court to proceedings in the nature of *quo warranto* to test the power of the corporation to exert the particular functions given by the act of Congress because they were inherently Federal in character, enjoyed by a Federal corporation, and susceptible only of being directly tested in a Federal court. Support for the challenge in argument is rested upon *Ableman vs. Booth*, 21 How. 506, 16 L. ed. 169; *Tarble's Case*, 13 Wall. 397, 20 L. ed. 597; *Van Reed vs. People's Nat. Bank*, 198 U. S. 554, 557, 49 L. ed. 1161, 1162; *State ex rel. Wilcox vs. Curtis*, 35 Conn., 374.

But without inquiring into the merits of the doctrine upon which the proposition rests, we think when the contention is tested by a consideration of the subject-matter of this particular controversy it cannot be sustained. In other words, we are of opinion that, as the particular functions in question, by the express terms of the Act of Congress, were given only "when not in contravention of state or local law," the state court was, if not expressly, at least impliedly, authorized by Congress to consider and pass upon the question whether the particular power was or was not in contravention of the state law, and we place our conclusion on that ground. We find no ambiguity in

the text, but if it be that ambiguity is latent in the provision, a consideration of its purpose would dispel doubt; especially in view of the interpretation which we have given the statute, and the contrast between the clause governing the subject by the state law and the provision conferring administrative power on the Reserve Board.

The nature of the subject dealt with adds cogency to this view, since that subject involves the action of state courts of probate in a universal sense, implying from its very nature the duty of such courts to pass upon the question, and the power of the court below, within the limits of state jurisdiction, to settle, so far as the state was concerned, the question for all such courts by one suit, thus avoiding the confusion which might arise in the entire system of state probate proceedings and the very serious injury to many classes of society which also might be occasioned. And our conclusion on this subject is fortified by the terms of section 57, chapter 106, 13 Stat. at L. 116, making controversies concerning national banks cognizable in state courts because of their intimate relation to many state laws and regulations, although, without the grant of the Act of Congress, such controversies would have been Federal in character.

As it follows from what we have said that the court below erred in declaring the section of the Act of Congress to be unconstitutional, the judgment must be reversed and the case remanded for further proceedings not inconsistent with this opinion. (37 Sup. Ct. Rep. 734.)

And it is so ordered.





TALKS ON BUSINESS BUILDING

By W.R. MOREHOUSE

Cultivating Old Business and Securing New Business By Direct Advertising

THE day of the great American ranch of thousands of acres of virgin land is fast passing away. In recent years, local and foreign syndicates acquiring these vast empires, have subdivided them into small parcels of land, which they have sold to the small farmer, who now makes scientific use of the soil.

In America, as in France, intensified cultivation of the soil is regarded as the secret of successful farming. Every day the old argument that quantity of production depends upon the number of acres under cultivation, is contradicted. The man who produces only a small crop is regarded as a poor farmer, and his method of merely scratching over vast surfaces of land is the object of ridicule.

Many bankers are doing no better in their line than is the farmer who still clings to the old idea that production depends altogether on a large acreage. For more than a decade, bankers have been engaged in extending their sphere of operation in order to control larger sources for new business. Figuratively speaking, bankers have been scratching over a surface of territory altogether too large to work to advantage.

To illustrate, much of our new business for the past ten years has been secured on principles very similar to a

potato race, that popular amusement at picnics. Fifteen potatoes are strung out in a row at intervals of ten feet. At the signal to go, the race is on, with each contestant pressing forward with every ounce of energy at his command. He snatches up the nearest potato and as he does so, turns, and in a second or two is back to the starting point where he deposits it and then dashes away for another. In this manner he continues until the fifteen potatoes have been gathered in and then they are at once forgotten. How many of our bankers are chasing after new business in very much the same way? How many are developing the business they have on their books?

When a stranger moves into certain of our American cities, it is said, "there is a scramble among the banks to see who shall secure his account." The object of the scramble is to "land" the stranger for an account in the least possible time, and then we are told, "the business-getting banks dash away after other prospects." It is a pity that in such cases no thought whatever is given to the question, "What is to become of these depositors once they are secured?"

WHY ACCOUNTS BECOME DORMANT

Many of the reasons for inactivity (lack of growth) in accounts may be

traced back to the beginning of the account.

(1) Many accounts should never have been opened. It was not a voluntary act on the part of the depositor. It meant merely his deliverance from the annoying presence of a tantalizing solicitor. Accounts opened under these circumstances are invariably unprofitable to the bank, and of no particular advantage to the depositor.

(2) Many accounts are opened owing to a sudden impulse to save, but without specific object for saving.

(3) Accounts are opened with the best of intentions, but in time the depositor becomes discouraged with the progress made, and "gives up."

(4) Many accounts are opened as the result of a firm resolution to save, but as the depositor has been in the habit of spending all his life, he finds he is unable to adjust himself to the new situation. His good resolves one by one give way before the temptations of the bargain counter, the many attractions of various pleasures, keeping up appearances, and high living, and so he spends instead of saving.

There are other reasons why accounts are dormant, chief among them being our own lack of interest in the account after we have secured it. Compare the little that banks are doing to encourage people to save with the thousand and one temptations on every hand, to spend. In some instances we even find merchants telling our depositors that buying their bargains is saving money.

Not only is the average person tempted six days of the week to spend, but on Sunday the preacher's plea is that he "give it away." It is only natural for the average person to yield more readily to the demand which is easiest to meet, and following the path of least resistance, he spends his money.

The fact is, accounts are dormant because depositors are too busy spending money to give any attention to building up their bank balances.

If the many dormant bank accounts already on our books are to grow, bank-

ers must take a greater interest in their depositors than they have in the past. This means that banks must encourage the saving of money by every means at their command, even if every bank must come to the point where it will *advertise*.

If the present stagnation in accounts is partly due to lack of interest on the part of banks, then an intensified cultivation of inactive accounts through direct advertising is imperative.

THE REMEDY

If an intensified cultivation of the soil produces large crops an intensified cultivation of inactive accounts, if carried out systematically and along proper channels, should produce correspondingly large results.

A PREVENTIVE NECESSARY

Not only are our banks in great need of some effective process that will stimulate their present inactive accounts, but they are just as much in need of an effective preventive—some plan which, when in operation, will check this growing evil before it affects the new accounts that are opened day after day. In other words, before beginning to "bail out the leaky boat," all leaks should be stopped, or else our progress is sure to be slow.

To prevent stagnation from setting in, new accounts must be analyzed from time to time in order to note their growth and see whether any has taken place. If after a reasonable time no additional deposits have been made, or in case the balance has been gradually reduced by a large number of withdrawals without corresponding deposits, immediate action is necessary.

The Guaranty Trust and Savings Bank at Los Angeles has a plan in operation in its Savings Department that does not permit accounts to become stagnant, especially in its small savings accounts where home safes are loaned with the accounts. A record is made of every small savings account the day it is opened, and the information filed in the New Business Depart-

ment. This record gives the depositor's name, his address, and the date the account was opened. If the account remains inactive during the sixty days immediately following the opening date, a letter, friendly and helpful in tone, is mailed to that depositor. This letter is accompanied by a piece of literature in which are recited some concrete cases where saving money has proved to be the secret of success in business and also in private life.

The following letter is being used at present, with gratifying results:

Dear Sir—Just what success are you having with the Home Safe loaned to you? Perhaps you have not saved as much as you had hoped and this may be the reason we have not heard from you.

Almost daily we are asked if it is necessary to fill a Home Safe before bringing it in to have the contents counted and the amount credited in the pass book. In every case we have recommended that the safe be brought in at frequent intervals, no matter what may be the amount saved. You will at once see how this will result in material benefit to you, when we explain that interest begins only from the date the money is deposited here.

Since we give to small deposits the same careful attention given to larger amounts, let us suggest that so long as you have saved anything at all, it is enough to bring in and place to your credit at interest.

We wish to assure you that your patronage is desired by this Bank and that should you call, you will receive our best attention.

Yours very truly,

J. F. ANDREWS,
Vice-President.

Of numerous letters that came in reply to this letter the following is a good specimen. It is reproduced to show that the intensified cultivation of inactive business is worth while.

Dear Sir—I am out of the city now and have been for the past three months.

That is the cause of my delay in bringing my Home Safe in to deposit my savings.

I will be back some time this win-

ter and will drop in with it the first opportunity I have to do so.

Thanking you for the interest you are taking, I am,

Yours very truly,
(Signed) BYRON Mc M——.

Sent out with the bank's letter is a folder entitled "What the Dimes Did." Those who do not respond on this first call are written to again in two months. Those remaining inactive after the second appeal are addressed for the third time.

It very frequently happens that a bank does not hear from its first letter until the person addressed has received the second letter. The following is a true copy of one of a number of letters received in response to the second letter:

Dear Sir—I have received two letters from you in regard to my small son Jack's bank account, and I wish to thank you for your kindly interest in him. Yes, he has quite a little more here in his bank, but I do not have the time to bring him in, or any one to leave the little fellow with, so I guess it will have to go without interest for a while, but did not want you to have the trouble of reminding him again, as it takes time and stamps.

So thanking you once more, I remain
(Signed) Mrs. W. M. P.——.

P. S.—Jack is just seventeen months old, so cannot call on you.

Where this plan has been followed judiciously, and letters helpful and friendly in tone used, accompanied by good literature, many persons have responded. Those having a sum of money already saved were the first to respond; others needed the correspondence to encourage them in forming habits of saving.

While nearly all responded in time by increasing their balances, circumstances undoubtedly prevented others from saving enough to deposit. A very small percentage of those reached were entirely indifferent, and because of their lack of interest, closed their accounts.

Assuming that other banks will adopt a similar plan to the one outlined for keeping all new accounts alive, and then put it into operation, let us con-

sider older accounts which are already stagnant.

INACTIVE ACCOUNTS

To segregate bank accounts that are stagnant is a very easy matter. The process simply requires that an analysis be made of the accounts on the bank's books, and a note made of those which have been inactive for a period of six months or more.

Where a bank carries commercial and savings accounts it is a good plan to keep these accounts separate, one list representing each. These two classes should be subdivided. For instance, there are two general classes of commercial accounts you must stimulate,—one being all commercial accounts that when active were of value, but are now inactive, with only a small balance remaining in the bank; the other class of commercial accounts including those that are now very active—in fact, too active to be profitable, owing to the small balance maintained. This suggests that the balance should be built up if the account is to be made profitable.

Savings accounts should be divided also into classes or lists. One list should represent all inactive savings accounts *where the balance maintained is in excess of the average balance of all savings accounts on the bank's ledger*. The writer's best judgment is that this list of accounts should not be stimulated, whether active or inactive. As a matter of fact, a savings account in which a large balance is maintained is enhanced in value because it is inactive, which is a good reason for permitting it to remain dormant.

The other list should contain the names of depositors whose balances are less than the average of all savings accounts carried, providing of course that they are dormant.

This outline leaves us two general classes of bank accounts upon which to operate: one general list comprises all dormant and very active commercial accounts; the other, all inactive savings accounts *with balances less than the*

average of all savings accounts on the books of the bank.

COMMERCIAL ACCOUNTS

List one includes inactive commercial accounts with only a small balance remaining, which, when active, were of value to the bank.

List two includes very active commercial accounts which are unprofitable because of the small balance maintained. It is necessary to have the depositor increase this balance.

The first class of dormant commercial accounts named requires close attention, and in many instances a personal interview with the depositor. Although they are inactive at the present time and have only small balances, at one time you found this class of accounts profitable to handle. Therefore, they are well worth your best effort to restore them to the original condition. Too much emphasis cannot be laid on the necessity for using great care in dealing with these once profitable accounts.

In nearly every case a personal interview will be found more effective than a letter and advertising literature, but where an interview is not practicable, correspondence affords the next best method of approaching the depositor. In writing to this class of depositors, brevity is imperative. A courteously-written suggestion that you desire to be of service to the depositor, followed by a cordial invitation to him to avail himself again of the facilities of the bank, should suffice for the first message. Or, if you have installed some new convenience to depositors since the account of the person addressed became dormant, call his attention to it and briefly show him in what way he is to be benefited. You need not refer to the account at all, if you think best not to. All that is necessary is simply to "play up" your service, or your statement, as the case may be, assuming that you were not aware the account was small and dormant. On the other hand, you may wish to refer to the condition

of the depositor's account. In that case, do so incidentally.

The second list of commercial accounts represents those opened as "accommodation accounts," or "petty household accounts," which have been at all times very active and which have never contained any appreciable balance, and therefore are unprofitable, and in some instances undesirable.

What is to be done with this class of accounts? Just now our bankers are not agreed as to the best way in which to deal with this parasitical business. Some are agreed it should be eliminated, others that it should be endured in order to retain the good will of the depositor.

In any event, it would seem that a bank is fully justified in undertaking to stimulate this class of accounts, even if it will not eliminate them. These depositors can be invited to build up their balances to the point, at least, that will enable the bank to "break even" on the account.

As any plan that will product results is also sure to bring about the closure of some of these accounts, it is a good idea first to examine all information at hand as to the antecedents of the depositor, and also his connections, to determine whether other members of his family are patrons of the bank, before interviewing him concerning the undesirability of his account. Other points to be taken into consideration are, whether or not he has considerable financial backing, or will some day inherit a goodly estate. Then his profession or business, and his standing in the community might be taken into account. In other words, it is a safe plan to estimate first as far as is possible the extent of his influence over others.

Not many of this class of depositors who are invited to build up their balances or close their accounts, if handled diplomatically, will undertake to injure the bank for its action. Don't dig right into them with a boast that you intend to throw them out. At the same time be firm, and as far as possible let them know that you believe in them

to the extent that you are confident that they can build up their balance if they will make an effort to do so. Show them that in doing so, they further their own interests even more than they benefit the bank. Set up before them a goal which they are to reach, and tell them that they can reach it if they will try, and assure them that when they do, you will reward their efforts by paying interest on their balances.

The following letter has been used with good results:

Dear Sir—A recent analysis has disclosed that your account, among others, is being maintained at a loss by reason of the large number of checks which you draw against a small balance.

It may be that you are using your check book indiscriminately, and as a result, drawing checks for trivial things. If so, we suggest that just a little care will correct this objectionable feature.

Probably you have never considered your account from the standpoint of profit or loss to us. Now that we have frankly called your attention to this phase of your banking business, we feel confident that you will make a sincere effort to increase your balance in the near future.

It would not surprise us, if by following our suggestion you will be able to increase your balance to the point where it will be possible for us to pay you interest on your funds.

Yours very truly,

Cashier.

Any person who is reasonable and fair will accept your proposition cheerfully, especially if he is made to feel that you are his friend and as such, interested in his success as well as the success of your bank.

Another class of these petty accounts is those accounts which although unprofitable while active, are now dormant, with only a few dollars or a few cents remaining. There is considerable doubt as to the results which might be obtained if these accounts are awakened to activity. They may become very active, as they were before, and because of the small balance maintained, become again expensive to handle, and it may then be necessary even to close many of them. The writer's experience

in dealing with this class of accounts is that it is far better to allow them to remain dormant, transferring the small balances to a special section of the ledger, and taking the aggregate only into the bank's trial balance, thus eliminating so much "dead wood" from the active accounts. Should one of these depositors call later and ask to revive his account, his case may then be treated solely upon its merits, and his request granted or rejected as, in the opinion of the person handling the situation, seems best for all concerned.

SAVINGS ACCOUNTS

Savings accounts may be divided as follows:

(a) All inactive savings accounts with balances less than the average balance of all accounts carried.

(b) All inactive savings accounts with balances under \$49.99.

(c) All inactive savings accounts with balances from \$50 to \$99.99.

(d) All inactive savings accounts with balances from \$100 to \$249.99.

(e) All inactive savings accounts with balances from \$250 to \$499.99.

Assuming that it is not good business to stimulate dormant savings accounts with balances in excess of the average balance of all savings accounts carried, we will exclude these from further consideration. As a hypothetical case, we will assume that the average savings account balance is found to be \$500. Therefore, accounts with balances ranging under this amount are subject to treatment.

The banker who has never had experience with stimulation work would do well to proceed cautiously, step by step, observing the effect of his activities as he prosecutes his work. It would be advisable for him to separate the list of savings accounts to be stimulated into no less than four subdivisions. Let the first subdivision represent the names of depositors whose balances are less than \$49.99; a second list is made up of depositors whose balances range from \$50 to \$99.99; a third list

from \$100 to \$249.99; and a fourth list from \$250 to \$499.99.

Naturally a bank can better afford to do its experimental work upon accounts ranging from one dollar to \$49.99. They are of less value than larger accounts, and in case any should close as a result of the experimental work the loss is only nominal; furthermore, the small accounts are usually in greater need of stimulation than accounts where the balances are ten times greater.

Another reason why it is desirable to subdivide the list of savings accounts to be stimulated, is to enable a bank to deal with its depositors as classes. For instance, write a special letter to depositors whose accounts are small and a different letter to depositors whose accounts are much larger, each letter built to fit that particular class to which it is addressed. To the first class, you would probably express yourself as desirous of being helpful, to the other class you would convey a word of encouragement.

STIMULATION IN OPERATION

Let us consider briefly an actual case of stimulation of inactive accounts. A large trust and savings bank on the Pacific Coast has undertaken this work, and at this writing is making very satisfactory progress. It has found that dormant accounts can be stimulated successfully, and made to produce results which more than compensate them for their time and money. They found upon compiling a list of dormant accounts, that they had on their books 10,720 accounts with balances ranging below \$50. The accounts were not only small, but all had been dormant for more than six months, and a large percentage of them for more than one year. To this class this bank mailed a letter, Dec. 10, 1915, enclosing with the letter a suitable piece of literature.

Of the 10,720 depositors addressed, 1685 could not be reached, owing to incorrect address, many of the addressees being more than five years old. This left 9,035 depositors who evidently re-

ceived the first letter. Of this number 2030, or 22 per cent, responded almost immediately by making deposits which amounted in the aggregate to \$17,112.36.

Sixty days later a second letter was sent, this time to those who did not respond to the first letter. Of the 7005 to whom this second letter was mailed, 395 had changed their addresses and could not be found, which left 6610 who evidently received the second letter. Of this number 940, or 14 per cent, responded by making deposits which in the aggregate amounted to \$10,672.11. Thus far 278 had closed their accounts, which now had reduced the list of depositors not accounted for to 5392. To those remaining on the list a third letter was mailed.

In this manner, the original list was worked through in twelve months, in which time four-fifths of those reached by mail were induced to make deposits to their accounts, and many deposited on several occasions.

Those depositing shortly after receiving the first letter were not forgotten, for their accounts were analyzed just six months from the date they received their first letter. Those who had not made a second deposit, were written to again and urged to deposit frequently. In fact, the whole list was thoroughly worked through by a systematic effort to stimulate every account, and to cause the depositors to make deposits at frequent intervals.

This effort of stimulation of one list of depositors, once regarded as so much "dead timber" — unproductive and worthless—resulted in an increase in their savings balances within one year of approximately \$50,000.

Under no circumstances are the results of any campaign to be measured by the amount of deposits secured. When this work has once awakened thousands of depositors to the benefits which accrue to them from making frequent deposits, they will be constrained to keep up the good work months after the campaign closes. Even if, after a year's campaign, the depositors whose

names are on lists for stimulation were forgotten, say, for a year or more, it is reasonable to assume that they would continue to build up their accounts.

After the dormant accounts which show a balance of less than \$50 are stimulated, the next list, representing depositors whose balances range from \$50 to \$99.99, may be taken up, and when the work on this list has been completed, the next list, and so on until all accounts subject to stimulation have been treated.

Other methods for stimulating inactive accounts might be substituted for the one briefly outlined and prove just as effective. However, the plan suggested has been tested and found desirable, and therefore, any bank adopting it will not be experimenting with its depositors.

If an intensified cultivation of bank accounts pays large dividends to the banks which have made it a part of their program, what bank can afford to leave it out of its plans of deposit building?

CONSOLIDATING A CUSTOMER'S BUSINESS

In the past, banks have failed to appreciate the importance of having those who are patrons of one department become patrons of other departments. In other words, banks have not tried to secure *all* of the business of any one of their patrons, allowing him to continue to keep his business divided up between two or more banks. For instance, a depositor in one bank is a renter of a safe deposit box in another bank, and a borrower in still a third bank. It was a surprise to me to learn upon inquiry among a large number of customers who have their business divided, that in nearly every case, the only reason for such a division was because the customer's attention had never been called to the advantages of consolidating his business in one bank. These facts indicate that the bank which suggests such an arrangement to its customers, which may be done through its direct advertising, is sure to profit materially

as a result of this recommendation.

LISTS

In the preparation of lists, the first step is to make up lists of the bank's customers by departments. After this has been done some one should check the names, being careful to write down the names of the customers of one department who are not customers of other departments. For instance, check through the list of borrowers, being careful to compare this list with the names of depositors in the banking department, to see how many borrowers carry accounts in the bank. Now make up a separate list of all borrowers who are not depositors, marking the list so as to indicate that it represents borrowers who should carry their accounts with the bank. Thereafter keep this list entirely separate from other lists, as the persons whose names appear thereon are entitled to a more intimate treatment than is usually accorded strangers. These borrowers are already familiar with the bank, and do not need to be introduced to it. In fact, let your whole appeal be confined to a concise presentation of the advantages which accrue to borrowers who carry accounts with the bank where they have been favored with a loan. A personal letter, cordial and friendly in tone, over the signature of the officers in charge of the loans, has been found effective in reaching borrowers. With this letter enclose a booklet describing the various ways in which a bank is prepared to serve its patrons.

The following letter is by way of suggestion only:

Dear Sir—Since you have found it advantageous to use the facilities of our Loan Department, may we not ask if there are not other ways in which we can serve you? For instance, have you ever considered opening an account with us and letting us serve you in this way? The advantages in such an arrangement are mutual.

No doubt, you will find it very convenient to transact all of your business under one roof, and with bankers who have placed a high value on your patronage.

When opening your account it will

not be necessary for you to be identified, as is the case with strangers. You are so well and favorably known to us that you will merely have to state that you are a borrower and you will receive immediate attention.

We are not only equipped to handle any form of account that your needs require, but to take care of all of your banking business, and we should be glad to give your business personal attention along all of these lines.

The writer would welcome an opportunity to meet you personally, and explain to you still other ways than those mentioned in which this Bank is particularly equipped to serve you.

Yours very truly,

Vice-President.

An equally good illustration of the use of lists of customers is that of safe deposit patrons who are not depositors. There is no good reason why they should not be depositors, in addition to being box renters. As with borrowers, they, too, are entitled to a more personal consideration than is accorded strangers. With the first letter to be mailed to them, indicate ways in which the bank is prepared to serve them to their own benefit, and better results will ensue. The following letter will serve as a suggestion:

Dear Sir—Since you have found it convenient to use the facilities of our Safe Deposit Department, may we not ask if there are other ways in which we can serve you?

Our "Term Savings Account" will make you a high-grade investment, absolutely safe, easily convertible into cash and earning four per cent. interest per annum, credited semi-annually. In this account you can invest any amount from \$1.00 up and receive interest from the day you deposit your funds.

Over 36,000 of our depositors use this account as an investment for their funds. On January 1st they will receive a semi-annual interest payment of over \$200,000. While you will not share with them in this vast sum, you can at this time open an account and on July 1st receive your proportion of our fifty-second semi-annual payment of interest to depositors.

To make it convenient for you to open an account we are enclosing a card which, when presented to our New Account Teller, will serve as an introduction. One point we wish to make

clear to you, is that you do not need a large sum in order to open an account; any amount from \$1.00 upwards will be acceptable for that purpose.

We shall be interested to know whether you have approved of our suggestion to invest your unemployed funds in a Term (four per cent.) Account.

Yours very truly,

Vice-President.

A card of introduction to the New Account Teller will be found helpful, as it serves to "break the ice."

After a bank has thoroughly worked over its lists of customers, and has made special lists of all of them who are not depositors, it should then reverse its method of procedure, and make other lists, this time of depositors who are not customers in its other departments. There is just as good a reason why depositors should be patrons of other departments, as for patrons in other departments to be depositors. When this is done, a bank has a nucleus of names which it can use in connection with its direct advertising. In fact, with many banks, this nucleus furnishes a sufficient number of names for any ordinary campaign of direct advertising. But as time goes on, and the bank finds that it can use effectively more names than those already compiled, the names of depositors whose accounts are closed should be added. This list can be used profitably to invite those who have severed their connection with the bank to avail themselves again of its services. This is another case where great care must be exercised, for this list contains the names of persons who for reasons unknown to the bank have seen fit to sever their connections with it. No doubt some have good reasons, while still others may have felt that the service was inadequate, or they may have imagined that they were discourteously treated. Regardless of the nature of the reason, one thing is certain. The bank must approach these former depositors in a very diplomatic way, if it is to get good results. The following letter will be found effective:

Dear Sir—It is with a feeling of regret that we note you have closed your

account. We hope, however, this is but a temporary arrangement.

As soon as you have funds to deposit, no matter how small the amount, we invite you to call and reopen the account. As all the preliminary work necessary for opening an account has been done, and you are so well known to us, it will only be necessary to call and ask for your pass book.

In the meantime we would like to have you feel that this is just as much your Bank as formerly and that the cordial relations which prevailed while you carried an account have not been affected in any way.

Assuring you that we have valued your patronage, and that it will be a pleasure to serve you at any time, we are,

Yours very truly,

Vice-President.

In the event that a bank does not get satisfactory results from its first letter, it would be well to mail a second, three months later. The following letter has been used with good effect:

Dear Sir—Just three months ago today we wrote you concerning the closing of your account.

Doubtless you will recall that we invited you to use the conveniences of this Bank freely, and to call upon us whenever in need of banking accommodations. May we ask—have you had occasion to accept our offer? If not, perhaps you will in the near future, in which event we request you to ask for any service that we can render.

Let us remind you that it is not necessary to accumulate a large sum of money in order to reopen your account, as we give the same careful attention to all depositors, no matter whether the amount deposited be large or small.

We wish to assure you again that your patronage is desired by this Bank, and that in the event you re-open your account, you will receive the best of attention.

Yours very truly,

Vice-President.

Any bank wishing to increase its business can do so, by an intensified cultivation of the business it has on its books.

SECURING NEW BUSINESS BY DIRECT ADVERTISING

All Directors are usually patrons of the bank in which they take an active

interest, but not every stockholder deposits in every bank in which he owns shares of stock. Therefore, the first list under "new business" is made up of the names of stockholders who are not patrons. In every case where a personal interview is not practicable, it is proper to write to them soliciting their cooperation in securing new business. As a letter to stockholders is quite difficult to write, the following letter is submitted by way of suggestion:

Dear Sir—The success attained by this Bank during the twenty-five years of its history has been achieved largely through the cooperation of its patrons, who have manifested a personal interest in the most practical way of recommending this Bank to friends in need of banking facilities.

Since the earning power of a bank's capital stock is enhanced by every material increase in its patronage and deposits, stockholders have a strong incentive to interest themselves in securing business for their institution.

No doubt you have frequent opportunities to recommend the facilities of this Bank to your friends and acquaintances. If at any time it is not convenient to introduce a friend in person, please use one of the enclosed cards. This will insure such personal attention as will cause your friends to appreciate your thoughtfulness in providing the introduction.

Assuring you that your cooperation will be highly valued, and with best wishes for the welfare of all your interests, we are,

Yours very truly,

President.

A bank may wish to include in its campaign of direct advertising all newly married persons, which calls for a letter along these lines:

Dear Sir and Madam—Not long ago a young married couple was brought face to face with the problem of a more economical management of their affairs.

Besides spending all of the husband's salary, they were spending their savings which they had accumulated before marriage.

The wife contended that they had not been spending any large amounts wastefully, to which the husband agreed. Finally both admitted that it was the small amounts—pennies, nickels, dimes

and quarters—that had been slipping away unnoticed.

How did they solve this problem?

They agreed to save every dime that came into their possession. With the first ten dimes they opened a savings account, and thereafter they deposited dimes regularly and systematically. In ten months they saved \$160.00. Later they chose to save not only dimes, but also pennies, nickels, quarters, halves and dollars.

Wouldn't you like to try this plan? We feel sure that it will do as much for you. With the first dollar saved, you can open a savings account; then come in frequently and deposit all that you can spare.

When you call ask for our "Joint Account," so that either of you can make deposits or withdraw funds.

Yours very truly,

Vice-President.

As time goes on, a bank may find that it can use a list of names representing wage earners. In addition to an appropriate piece of printed matter, a personal letter will be found effective. The following letter is offered by way of suggestion only:

Dear Sir—Wouldn't it be a good plan for you to save a part of your income? Just what would happen if it should suddenly be cut off? Of course, you don't expect it to be, but what if it should? Your expenses would go right on just the same, and your needs might be greater. Have you ever considered how long your surplus would hold out under such conditions?

In any event, the whole problem will be most easily solved if you open a Savings Account. You will then have an emergency fund on which to draw in times of distress—when there is nothing coming in and everything going out—or, say, when illness has you flat on your back.

The best time to start to build up such a fund is now, beginning with a part of your spare change. Thereafter, instead of spending all of your income, just save a little each day, or, say, each pay-day—just whenever funds come into your possession. Come in frequently, even though you have but a small amount to deposit, for any sum is acceptable to us.

If you follow this suggestion, your emergency account is sure to grow rapidly, and later you may safely invest a part of it in a lot, or in some business, or use it to meet the expenses of a

vacation, or a visit back to the "old home."

Open an "Emergency Fund" Account to-day.

Yours very truly,

Vice-President.

The second letter to wage earners who do not respond to the first letter, should be along the same general line, but at the same time slightly different:

Dear Sir—How many times have you heard this remark: "I just wish I had a little money—a sum with which to meet my expenses while I could prepare myself for a better position"? This statement suggests that there are many men and women who aspire to better positions than they are now filling, but are held back just because they have neglected to save money.

How natural that we should all aspire to better living—a higher position at a salary commensurate with the accompanying responsibilities! But to realize these fond hopes we must begin now to plan for the day when we shall have the opportunity to advance. In what better way can you plan to this end than to begin to save a part of your present salary—regularly and systematically, never allowing a pay-day to pass without saving something.

As we give the same careful attention to small sums as to larger amounts, come in and open a savings account for one dollar or more, and thereafter deposit frequently—any sum is welcome.

It will surprise you to see how fast you can build up a reserve fund by systematic saving, and it won't be long before you will have a capital which you can use to "boost" yourself into a better position.

When you call, ask for our Time Savings Account, as it pays a liberal rate of interest.

Yours very truly,

Vice-President.

A third letter is as follows:

Dear Sir—How often do you find yourself saying, "Yes, I'd like to, but I can't afford it"?

No, you can't afford it; your income barely keeps pace with the increased cost of living—with the thousand and one little expenses which creep in—the unexpected demands for money which must be met.

But there is a way out of the difficulty—

It's just this: You must first reduce your expenses to the point where you can save something regularly each day, or at least every pay-day, and then make it a rule to deposit your savings in this Bank at interest. There is no better time for you to begin to save than with the very next item of expense that is unnecessary, even if the amount involved is as small as one dollar. That sum is sufficient to open a Savings Account. Thereafter come in frequently, and deposit any sum that you may be able to save by eliminating the unnecessary things.

If you doubt your ability to resist the old temptation to spend, call and get one of our Home Safes, take it home with you, and just the moment money comes into your possession drop a part of it into the Safe. You can't spend it when you do this, for we have the only key to your Safe. By the time you find it convenient to bring the Safe in to be unlocked, the probabilities are that you will no longer want to spend it, but like hundreds of others who have tried this plan, you'll say, "Oh, just credit my account."

Your account is sure to grow rapidly, and in a short time you will probably want to make an occasional withdrawal, which will mean that when you do, you can afford it. Try the plan of opening a Savings Account to-day.

Yours very truly,

Vice-President.

A good letter for professional and business men, who are usually "rushed" for time, as follows:

Dear Sir—You don't like "red tape" in business, do you?

Neither do we; and for that reason the convenience of our depositors has been our object in making our service as simple and yet as complete as possible.

It will probably take you longer to buy an article of merchandise at one of our stores than to open an account at this Bank, because we have eliminated all "red tape."

The fact that so many of our new depositors have commented favorably upon the simplicity with which an account is opened with us is our reason for calling your attention especially to this part of our service. It isn't necessary for you to wait until you have "lots of time," because it will not take more than five minutes. This is a busy bank for busy people, with a service that meets every need.

Again, there will be no "red tape"

about the amount you are expected to deposit in order to secure an account. come in with what you can spare, even if it is but one dollar, and we will be very glad to serve you. You will find it even more simple to deposit or withdraw funds later on.

Inasmuch as we are agreed that simplicity is better than "red tape," and because of our confidence in our ability to serve you satisfactorily under all conditions, we urge you to make use of our facilities without delay, and to open an account with us soon.

Yours very truly,

Vice-President.

A good letter to newcomers is as follows:

Dear Sir—Noting that you are a recent arrival in Los Angeles, may we suggest that you come direct to us when first you have occasion to use a bank? You will find us not only well equipped to meet all of your banking needs, but glad to serve you in any capacity.

For the immediate future you may wish only to cash a check or draft, or to change money. However that may be, we want you to feel just as welcome as though you were calling to open an account. In any event, we will extend to you every accommodation within reason and without expense to you.

Permit us to explain that we are conducting a departmental banking business; that is to say, our service includes Savings, Commercial and Trust business. On our main floor you will find our Commercial and Savings Departments; on the second floor is the Trust Department, while in our basement we have as commodious and well-arranged a Safe Deposit Department as is to be found on the Coast.

It is needless for us to refer to the history and success of this Bank, unless it be to recommend that you inquire of any resident of Los Angeles as to these points. The enclosed booklet gives such information as a new resident will find it convenient to have.

Don't hesitate to call, whether you wish to open an account or to ask a favor, and you may be assured of our best attention.

Yours very truly,

Vice-President.

Or, you may wish to sell securities by direct advertising, in which case you will mail letters about as follows:

Dear Sir—If you could buy mortgage loans or bonds right now with absolute safety, would you be interested? Doubtless you would, and that explains our reason for writing you to-day.

As a banking institution of enviable reputation we could not under any circumstances afford to sell you mortgages or bonds of questionable value; therefore, let it be definitely understood that there is no speculation in the securities we have for sale.

For your information, we do not hesitate to say that many of the mortgages represent money loaned by us directly to our clients, whom we know to be responsible in every way, and whose security is worth at least double the amount of the loan. As to the bonds, they are purchased for us by one of our officers whose years of experience in buying and selling securities fully qualify him to select bonds of proved value.

An attractive feature, aside from the absolute safety of the securities, is the high rate of interest which they bear to the owner.

Let us assure you that if you have funds awaiting investment you can make no mistake by following the suggestion in this letter.

If we can serve you in any capacity, you are cordially invited to call.

Yours very truly

Vice-President.

Direct advertising is a good substitute for a personal interview, as it provides a way by which the bank can reach prospective customers direct with a message that has many of the good qualities of a personal interview.

Next in importance to a good letter is a good circular, or a printed booklet.

Because of the important part which House Organs and Booklets take today in our bank advertising they will be treated in a separate article.



International Banking and Finance

SPECIAL

The BANKERS
MAGAZINE

SECTION

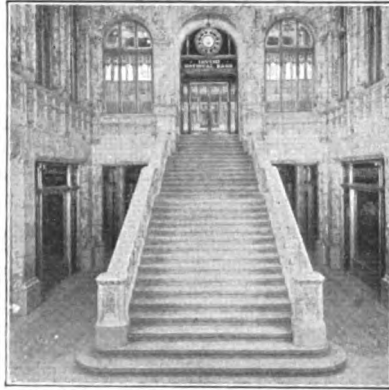

A Strictly Commercial Bank

Specialized domestic departments, each organized to perform a certain service carefully and expeditiously, and a highly developed Foreign Department with personal representation and connections in important foreign commercial centers, enable the Irving to meet every requirement of commercial banking.

IRVING NATIONAL BANK

WOOLWORTH BUILDING
NEW YORK



RESOURCES OVER
\$100,000,000

The New Era of American International Trade and Finance

By JOHN CLAUSEN, Vice-President Crocker National Bank, San Francisco

THE fourth year of the war has commenced and not the least among the many evils of a prolonged international struggle must be considered the artificial world-wide conditions which such a state of affairs



JOHN CLAUSEN
Vice-President Crocker National Bank, San Francisco

brings about. All the usual and known relationships of commerce have been so disrupted and altered that new means for carrying on any form of international trading have been a daily issue and of constant necessity.

The test in so far as it has served to rouse American public opinion in international affairs and to an aggressive understanding of the interdependence of commercial nations of the world, has been of especial benefit to the United States in the unprecedented economic changes which the war has brought about.

The financial and commercial interests on both sides of the Atlantic should at this time give careful study to the outlook after the war, so that the world-wide recuperation in finance and trade may proceed along practical lines and prevent strain upon the credit system of the world. If the signs of the time are rightly read a true perspective would seem to indicate keener and more tense economic rivalry among the world powers than ever in the days before.

The country is in need of the fullest co-operation and co-ordination of interests — commercial and financial — to work for a clearer understanding and appreciation of the responsibilities of business towards the well-being of its citizens. It resolves itself into a complex and practical awakening for a scientific development of the trading powers of our country.

While there is doubtless too much optimism in some quarters, there is bound to be a considerable change in the financial position of the United States after the war. The volume and direction of our trade will be different. The ability of European nations to furnish capital to other countries will be lessened, perhaps for a period of many years to come. South and Central America, China and Mexico may turn

U. S. Army or Navy Red Cross or Y. M. C. A.

Letters of Credit are the safest and most convenient medium for carrying funds.

During the war we are issuing such Credits, *free of commission*, to officers and men in the U. S. Army and Navy, and to those engaged in Red Cross or Y. M. C. A. work.

We have also sent our American representative to France for the convenience of our friends, with headquarters at the office of the Credit Commercial de France, 20 Rue Lafayette, Paris.

BROWN BROTHERS & CO.

Philadelphia

NEW YORK

Boston

BROWN, SHIPLEY & COMPANY

Founders Court, Lothbury
LONDON, E. C.

123 Pall Mall
LONDON, S. W.

to us more than ever before for their financial needs.

Many important changes in our national economics are occurring which will probably increase our capacity to purchase foreign securities notwithstanding the calls which may be made upon us for industrial expansion within our own borders.

In wealth, our superiority is undeniably great, but it is not yet certain to what extent this wealth will be available to support our international trade and other activities. In England there is found a large body of investors accustomed to buy the securities of enterprises in all parts of the world. A similar body, although less numerous, has been developed in France, Germany, Holland and Belgium. The question with us is whether we will know how to use our new position in world affairs, and our new wealth in such manner as to internationally strengthen ourselves and develop such a constituency behind our industry.

Our people have not been generally accustomed to make investments at a distance. With all parts of the country rapidly developing, their natural tendency has been to invest in land and local enterprises. Such investments have served the nation best in the period of its own early development, but as the country grows older and richer there is danger that the preference for land investments may carry prices of the soil above conservative values, and it is desirable that new channels for the disposition of the country's accumulating capital be opened up. The distribution of the Liberty Loan has shown that there is enormous buying power in the country for securities that have the confidence of the public, and which are energetically brought to their attention, particularly if a patriotic purpose is to be served. It is of the highest importance to familiarize our people with the fact that after the war is financed the next important task for this country will

be that of financing the rehabilitation of industry throughout the world.

INTERNATIONAL LOANS AND FINANCIAL CONTROL

Prior to the outbreak of the war the various nations of the world could be grouped with some accuracy as "creditor" or "debtor" countries. Thus, Great Britain, France, Germany, Belgium, Holland and Switzerland were classed under the former category, with the people of those countries as a whole lending more than they borrowed. The United States, South and Central America, Mexico, China and other younger nations in the state of industrial development, were designated in the latter class, in that their citizens as well as their governments borrowed abroad more than they loaned.

There was a well-defined movement of capital for investment from the lenders to the borrowers, accentuated by the payment of interest and dividends and the final return of principal whenever the loans fell due.

A volte face of the situation occurred when the war broke out and at once created considerable disturbance in the investment markets. The volume and direction of trade were seriously interfered with. Stock exchanges were closed for a time and trading carried on only under the closest restrictions. Even new listings of securities were permitted in some countries only after government sanction had been secured.

The countries in need of capital were unable to secure financial assistance through the usual channels, resulting in a release—by sale or otherwise—in our markets, of a vast amount of American securities formerly held in Europe.

This unprecedented demand on American capital necessarily diminished the amounts available for local enterprises and gave need to a great many economies on the part of our people, although the enormous activities induced by war orders tended to conceal that phase of the situation on account of the great wealth which those contracts brought to our doors.

There are but few countries so situated with regard to their natural utilities of soil and climate as to be independent of other countries for the supply of products which have become necessary to the comfort and well-being of their inhabitants. The United States, strictly speaking, is not one of that group and international commerce is therefore a matter of necessity and eminently conducive to our wealth and prosperity.

We have a country nearly as large as Europe with a population of more than 100 million people and a national wealth of over 200 billion dollars—nearly as great as that of Great Britain, Germany and France combined—but in spite of steadily augmented wealth and expansion in trade, we are particularly liable to suffer unless we realize some of the economic difficulties which are before us, necessitating firm and original methods of treatment.

Whatever the motive, a large part of the industrial population is almost as much employed for warlike purposes as the belligerent peoples, and the financial obligations incurred as a result of the present war have increased enormously. An appreciable portion of these expenditures will necessarily result in a destruction of capital and this will in future have a very important bearing on many of the world's problems. There must be considered the labor of rehabilitation and the test of reorganization of the countries of Europe when the war is brought to an end.

The United States perhaps is best able to meet with equanimity the great readjustment. We will not have been as long in the war—our losses in men will consequently have been lighter—and our financial position, as it is today, will be stronger. Notwithstanding these advantages, we must be prepared to meet aggressive European trade combinations in the field of international competition and keep pace with the world's industrial advancement—which may be expected to be one of the few benefits arising from the present worldwide conflicts of nations.

The First National Bank of Chicago

welcomes and appreciates the accounts of banks and bankers. Its extensive clientele, developed during more than fifty years of consistent, considerate service, is splendid endorsement of the agreeable and satisfactory relations maintained with correspondents.

Capital and Surplus, \$20,000,000

JAMES B. FORGAN
Chairman of the Board

F. O. WETMORE
President

THE GOLD SITUATION

No more interesting chapter will be written in economic history than that which deals with the problems for the proper distribution of the world's gold supply. The phenomenal accumulation of that metal in this country has been a source of concern to bankers and economists alike.

The thought has been expressed that if the war is prolonged for an indefinite period, the Bank of England might suspend specie payments, although if London is to remain the financial center of the world it can only keep its position by ability to supply gold when that metal is demanded. Then again, it has been opined by leading authorities that if the present unparalleled inflow of gold continues to the United States, the possibility is presented that a general demonetization of gold as a standard of value may be brought about by a combination of the European powers. In this, however, all factors do not wholly concur. It is rather the belief that the

more important phase of the situation is demonstrated in the advantage to the world at large of having the gold more evenly distributed among world markets, to prevent the waging of commercial wars by a union of one or more nations against another.

The disproportionate distribution of the world's supply of \$8,550,000,000, calculated to be the gold in existence, presents a new problem in the international credit structure. The figures made public by the Department of Commerce of our gold imports during the fiscal year ending June 30, 1917, show that we received more than \$977,000,000 of the metal, which exceeds our total gold imports for the entire twelve-year period preceding June 30, 1914.

Since the beginning of the war in Europe gold imports have totaled \$1,677,000,000, and since our entrance therein this country has been enriched with that commodity to the extent of \$214,000,000. In April of this year those figures suddenly dropped to al-

most negligible proportions. While in exports of gold from this country there was no immediate change, for the month of May statistics show that nearly \$58,000,000 passed out of our hands to foreign countries, with an increase in June to \$67,000,000. While no figures are available for subsequent months, it is an accepted conclusion that they exceed the exports of gold during any month of our economic history.

We have suddenly been brought to the realization that notwithstanding a steady inflow, calculated to be in excess of \$540,000,000 during the current year, the export of gold reached the amazing amount of \$300,000,000 for the same period with every prospect of increase. Were it not for the fact that our gold holdings have increased fifty per cent. to sixty per cent. since the world struggle began, this country might well on this account be called upon to face serious difficulties in its finance.

Our gold exports during the past have not arisen, as a general rule, by reason of our own indebtedness, but rather towards liquidating adverse trade balances of other nations and in no small measure because of such shipments presenting profits as a purely exchange operation.

To sustain our financial strength, an embargo upon gold exports was placed in effect on September 10, 1917, for the purpose of controlling and conserving our holdings of that precious metal. It is naturally to be assumed that the powers so vested in the hands of the Secretary of the Treasury, in collaboration with the Federal Reserve Board, will not place restrictions upon the export of gold in settlement of trade balances against the United States, and the best results can therefore only be expected from the operation of the law.

In the international relations gold is not alone a medium of payment and exchange, but expresses alike a fundamental measure and unity for the value of labor in its relation to trade. Its buying power does not increase or decrease—it is necessarily stable—but

rather the value of the commodity which is traded in that varies in price.

THE SILVER SITUATION

The London market has tried in vain to control and regulate the price of commercial bar silver, but the acute world shortage has broken all bounds and dollar silver is no longer a speculative prophecy.

In the opinion of those who study the situation, the apparently sustained high levels have not yet stimulated the reworking of mines bearing low grade ore. Immediate activities, however, along these lines are inevitable because of the demand for silver coinage, especially by the nations in Europe, where gold is rapidly being withdrawn from circulation in order not only to increase and strengthen their holdings, but to uphold some metallic reserve as a basis for the enormous issues of currency which has been brought into circulation.

The price of silver has been steadily soaring to limits unknown for many years, and it may be of interest to briefly review this movement with the statement that during the Civil War and up to the time of demonetization of silver in 1873, the white metal was selling as high as \$1.29 per ounce, with a subsequent record in 1890, when it receded to \$1.21 per ounce.

Owing to the repeal of the Silver Purchase Act and in no small measure because of closing the Indian mints to free coinage, which were outstanding events during the memorable year of 1893, a steady decline in the value of silver was noticed. Of no little concern to the silver-producing countries was the phenomenal drop experienced shortly after the outbreak of the European War, when the quotation touched a low record of 44 cents per ounce and as is generally the case, even at that quotation, the white metal went begging on the market.

The United States is now the largest producer of silver with 72,833,000 ounces, or in other words, forty-two per cent. of the entire world's output, which in 1916 was given as 172,383,000

Redmond & Co.

33 Pine Street
New York

High-Grade Investment Securities

Government
Municipal
Railroad
Public Utility

Correspondents will kindly indicate their individual requirements to Dept. B

ounces. In a twenty-year period, ending with 1916, the production of this country increased by 14,000,000 ounces, whereas the appreciation in output for all other silver-producing countries combined was only a total of 1,000,000 ounces.

The principal market for silver is ostensibly China, and it may be of interest to here state that silver bars as such do not circulate in that republic and are principally imported for commercial purposes in connection with the active silversmith trade and only in a small degree for coinage.

Up to the present time silver bars imported into China have been composed almost exclusively of English bars, American bars—termed “Selby”—and Canadian bars which are traded in under the name of “Trail.” The importation of the first mentioned stamp has practically been discontinued due principally to excessive freight and insurance costs and the only bars which are

brought to that market therefore are American and Canadian.

Under normal conditions the “Selby” bar is the more acceptable, which with a fineness of 999 commands a premium in the interior of China over the best Chinese sycee (shoes) the weight and fineness of which, while varying in every large part of that republic, is set at 1,000 pure. The strange fact is therefore brought out that the 999 fine “Selby” bars are quoted as 1000.7 fine on account of the premium which they carry. Omaha bars while known in that market, are now seldom dealt in as the price compares unfavorably because of the fineness being only 998½ for which the Chinese make a difference of ½ of one per cent. as compared with the “Selby” bar.

It may not be amiss to here mention that silver bars imported into the Chinese markets, of which Shanghai presents the most favorable, bear impressed figures the ounces, in two decimals, to meet the prevailing custom.

The significant features surrounding the present state of affairs in the silver market emphasizes the indisputable fact that there is every indication that world economics are being remodeled by the war and that the finance of international trade may therefore be destined to proceed along new and divergent lines.

**ADVANTAGE OF AMERICAN OVERSEA
BANKING**

At a meeting on June 15, 1917, of the Council of Association of Chambers of Commerce of the United Kingdom held in London, a resolution was passed expressing appreciation of the steps taken by their government towards the formation of a British Trade Corporation. According to an official bulletin the purposes and activities of this newly established bank, are given in the following terms:

"That the fundamental object for which the charter has been granted is the giving of financial assistance to British traders and manufacturers, especially in connection with overseas trade, and that the corporation is under an obligation to give full effect to such object, and will be accessible to the business public for the purposes of consultation and otherwise; that the corporation is not intended to be, nor will it operate as, a competing contractor, merchant, or trader, and that its enterprises shall be directed to the furtherance of its aforesaid fundamental object; that the powers and privileges given to the corporation by the charter are intended to be and are the machinery by which the corporation will effectuate its said fun-

damental object, and will be exercised for the purpose as a means of, and with the view to the carrying out or furtherance of the same, or so as to enable the corporation to deal with situations arising by reason or in consequence of such carry out or furtherance, and that nothing in the charter has the effect of conferring any exclusive privilege on the corporation as regards access to government information or of placing it in any preferential position as regards the representation of British trade or finance, or of conferring upon it the right of acting as agent of the government except upon appointment in each case or of excluding the government from selecting other agents in cases in which they see reason for so doing."

It may be freely admitted that the light which this formal declaration has thrown upon and the attention which it has been the means of drawing towards the subject now under consideration, for extending American banking interests in foreign fields, appears to have initiated alike our aspirations and desires for strengthening active commercial relations between the United States and other foreign countries.

With the endorsement of the Chamber of Commerce of the United Kingdom—representing some 35,000 manufacturers and traders—success is presaged for this financial corporation. It acknowledges the move to be for the best interests of British commerce towards supplying the necessary facilities for the furtherance of its foreign trade.

This institution incorporated by royal charter for a period of sixty years with an authorized capital of £10,000,000 (\$50,000,000), with £2,500,000 (\$12,500,000) fully paid up, if operated under efficient management with the power to base on its capital a forceful system of credit, will no doubt soon gather the nucleus of a large foreign business and attain its mission in becoming a strong link between British industry and the British investor.

FEDERAL RESERVE ACT

No measure has been of greater importance, as affecting not merely the local financial condition in the United States, but the entire situation from an international standpoint, than the Fed-

Liberty Trust Company

8, Place Edouard VII.

Total Resources Over

\$10,000,000

PARIS - FRANCE

eral Reserve Act. Its facilities for branch banking in foreign countries especially mark a great improvement of system in our local and international relations likely to give the United States greater power in foreign trade. If the United States succeeds in establishing a system of banking thoroughly suited to modern conditions, a great forward step will have been taken in consolidating the progress already achieved through the financial and industrial energies of our population.

The banking element in our country should deal with these problems as seriously as is deserving and seek what help may be given to make the purpose of the law concrete facts by the scientific employment of capital in the shape of organized facilities, which in turn react to the benefit of the public from the operation of a well-regulated and uniform banking system.

Our foreign relations cannot successfully be developed so long as it is necessary to operate through banking institutions of competing countries and while the Federal Reserve Act provides for the establishment of branches by member banks in foreign countries and permits coöperative participation in the organization of banking interests beyond our borders, strange to say but few institutions are taking advantage thereof.

FINANCING FOREIGN TRADE

In banking as in all other lines continual changes are taking place, partly due to new methods and procedures for carrying on trade. It often appears that we lack the financial medium for proper conversion of credit to precede foreign trade in normal times, and there is induced a feeling in trade circles throughout the country that opportunities exist for the establishment of a new financial institution having for its sole object the financing of international trade enterprises some of which, while sound enough in themselves, do not strictly speaking come within the bounds of operation as performed by national and state banks.

The great question with us to-day is



Advice to Investors

Purchase your securities through responsible dealers who have proper facilities for investigations and a reputation to maintain for reliable advice.

K. N. & K. are always posted on general market conditions, and their views are at the disposal of investors through their monthly review of

"The Investment Situation"
Write for pamphlet L-I

Knauth · Nachod & Kuhne

Members of New York Stock Exchange,
Equitable Building,
NEW YORK CITY.

how to develop our banking system on the foundation already laid, so that it will become the permanent means for credit of our productive and commercial system. As an economic principle no section of our country should be permitted to finance itself at the expense of another section, when it has the wealth to finance itself—especially when all the machinery for this purpose exists in the conversion of natural resources and well-sustained credit adequate for its needs.

Through the Federal Reserve Bank or in harmonious coöperation by itself or members with financial interests in this country, the creation of a powerful international credit banking corporation would seem opportune if organized to finance oversea investments, and through its medium effect distribution thereof to the investing peoples of our country in the shape of acceptances, bonds and other high grade obligations

guaranteed by the capital strength and resources of the institution.

The lack of such investments—so essential to the promotion of foreign trade—have proven our deepest problem, and we cannot look for a solution until at least part of the financing in foreign countries is cared for with American capital which would prove the strongest commercial bond with the greatest possibility for the upbuilding of permanent trade. On the ability of our bankers to meet this test in organized form will rest the possibility of attaining a large foreign commerce—bound closely by financial and commercial ties in all its ramifications.

EXPORT COMBINATIONS AN AID TO FOREIGN TRADE

We must face conditions as they now appear and recognize that of vital concern are the broader international problems of industrial coöperation and efficiency. It is wise, even at this period, to prepare for financial and commercial conditions that will succeed the present world-wide strife. The European nations especially are going to make as active an effort for export trade as their resources and financial conditions will allow.

In England there is now busily engaged a "Reconstruction Committee" and in Canada Trade Commissioners have been appointed whose duties are to advise the Board of Trade promptly of all opportunities which may arise for

the extension of British commerce; to report in regard to contracts open to tender and as occasion requires on the nature and extent of foreign competition with British merchandise, with the furnishing of periodical lists of probable buyers of British goods.

For the purpose of promoting closer relations with our neighbors in the Southern Hemisphere, a Latin-America Chamber of Commerce has been formed in Great Britain to promote their trade with South and Central America, Mexico and the West Indies. The association is a non-trading and non-political body with the management in the hands of a council elected by the members, special sections having been formed for each of the important trades and industries in Britain to coöperate with like committees established by that association in the various republics of Latin-America to more effectively carry out the object of the move.

Similar activities are being promulgated in other countries with visions of activities towards a transformed future in all lines of human endeavor.

Our commercial and financial organizations have grown up without much system and it is time that we depart from the old practice in adopting real activities along new and improved lines. Everything that will add to the ability of this country to hold its rightful position in foreign trade should be encouraged and developed to the utmost ability of all elements.

Manufacturers are beginning to realize that their most aggressive competitors are not their fellow-countrymen engaged in international trade, but rather the powerful combinations of merchants in other countries. Coöperative combinations such as may be deemed expedient to develop our foreign relations in normal times are essential and should in no sense be considered a contractual restraint of free trading. A recognition of this principle in overseas trade development is most necessary to our economic progress.

The Webb Bill, destined to promote export trade by legalizing joint foreign trading agencies of American exporters,

NOYES & COMPANY

Established 1879

Foreign Bills

Government and Municipal Bonds

8, Place Edouard VII.

PARIS - FRANCE

London and River Plate Bank, Limited.

HEAD OFFICE: 7 PRINCES STREET, E.C., LONDON.

Paris Branch: 16 Rue Halevy.

Antwerp Branch: Temporarily in London.

	(\$5=£1.)
CAPITAL (Authorized) - - - - -	\$20,000,000
SUBSCRIBED CAPITAL - - - - -	15,000,000
PAID-UP CAPITAL - - - - -	9,000,000
RESERVE FUND - - - - -	10,000,000

DIRECTORS.

E. ROSS DUFFIELD, Esq., *Chairman*
The Hon. HUGO BARING.
WILLIAM T. BRAND, Esq.
JOHN G. GRIFFITHS, Esq., M.V.O.

ROBERT A. THURBURN, Esq., *Managing Director*
KENNETH MATHIESON, Esq.
HERMAN B. SIM, Esq.
DAVID SIMSON, Esq.

LONDON BANKERS.

THE BANK OF ENGLAND.

THE LONDON COUNTY AND WESTMINSTER BANK LTD'

BRANCHES IN SOUTH AMERICA :

BRAZIL :—Para, Pernambuco, Rio de Janeiro, Santos, Sao Paulo, Bahia, Curitiba, Victoria, also an agency at Manaus. URUGUAY :—Montevideo, Montevideo Sub-Agency, Paysandu and Salto.

ARGENTINA :—Buenos Aires, Rosario de Santa Fe, Mendoza, Bahia Blanca, Concordia, Tucuman, Cordoba, Parana. Also in Buenos Aires:—Barracas al Norte, Once, Boca, Calle Santa Fe 2122 and Calle B. de Irigoyen 1138. CHILE :—Valparaiso, Santiago.

Correspondents in all other places of importance in these South American Countries.

Documentary Bills Bought, Advanced Upon or Received for Collection.
Drafts and Cable Transfers Sold on all Branches and Agencies.

Commercial and Travelers Letters of Credit Issued.

New York Agency 51 Wall Street,

W. R. ROBBINS, AGENT.

was passed by the House on June 13, 1917, by a very small majority. The Senate has still to act on the bill. Its enactment would enable American exporters coöperatively to compete with other foreign countries in international trade. This measure seems essential to promote our relations with foreign countries and it would seem to the interest of every international trader that the bill become a law.

The thought is expressed on many occasions that the development of commercial relations with foreign countries can best be accomplished by more intimate affiliation and coalition of the United States Chamber of Commerce and its sister organizations throughout this country with those of the trading nations of the world. Experience prompts the suggestion that a workable plan towards that end be initiated—strengthened with the recommendation that exhibits of products and industries from foreign countries be established in chambers of commerce of the United

States and like displays made of American products in commercial centers abroad. Such a plan could of course be most effectively carried out by each section of this country selecting that part of the world in which it feels that the products of one and the other are the most likely for interchange.

Just as there has been mutual financial arrangements for the time of war, so when peace arrives like measures will be necessary before such treaties between Great Britain and her Allies can be terminated. Each country will have to assist the other in getting back to normal conditions. The period of readjustment will take time and European manufacturers will no doubt be called upon to content themselves with the fact that as a result of the scarcity of labor the general wage scale will be materially heightened. In summing up the situation the outlook in every direction is full of interesting possibilities which may present difficulties in their solution when it is considered that

COX & CO. (France) Ltd.

place their branches in France at the disposal of the Military and Naval forces of the United States, in Europe, for the remittance of funds and general banking business.

This bank was formed as a subsidiary of Cox & Co., founded in 1758, 16 Charing Cross, London, the official British Army Agents, for the convenience of the British Army in France.

Branches have been established with a British Staff at all the chief military bases.

Paris, Rouen, Havre, Boulogne, Amiens, Marseilles,

and agencies at

COX & CO., 16 Charing Cross, London,

and

LONDON & SOUTH-WESTERN BANK, LTD.,

170 Fenchurch Street, London.

who are the joint proprietors.

the situation will be one without precedent.

THE PROBLEM OF FOREIGN EXCHANGES

The difficulties of commerce in war times have taught us much about the laws of supply and demand and have generally advanced the knowledge of our people regarding financial operations. We have had to meet and solve many new and complex problems. Huge volumes of war orders are still pouring in upon us, the financing of which in itself is a gigantic task. The maintenance of foreign exchange rates, at a level that would make possible a continuation of exports, has been wrought with difficulties. The furnishing of capital to finance the belligerents is another aspect of no small concern.

A glance at the foreign exchanges is sufficient to demonstrate that there are yet problems of great importance to be overcome. Probably, there was never greater need than now for coöperation of our financial element to devise a workable plan for the control of the situation with which we are confronted. In reality a very important issue is presented, namely, whether the standard of value of the world would in future be gold alone or form a combination of silver and gold and if so, what effect such changes would have on the trading power of nations. It is obvious that if a bimetallic standard were adopted as media, the question of the rate of exchange between the metals themselves would become one of great issue.

There may arise a scarcity of gold available as money for the purpose of effecting the sale and purchase of commodities or as affecting the economic position of governments and banks and the availability of that precious metal in proportion to liabilities.

The simultaneous purchase and sale of bills of exchange between different financial countries would normally bring the respective rates to an equal relation with parity, but the shipping conditions in themselves have tended to check the export of commodities, resulting in a scarcity of the usual supply of international trade bills. The restricted character of the exchange market and the difficulties which governments themselves have placed in the way of the free distribution of business and the recent embargo against shipments of American merchandise to neutral countries has further complicated the situation.

Of no little perplexity is the problem brought about by the active trading with and between the neutral countries, where England particularly is liquidating over the United States because of the comparatively little depreciation of her exchanges here and by reason of the financial centers in the United States presenting the best place and condition to realize on sterling exchange as against a heavy depreciation if negotiated in European markets. This situation has naturally created an excess supply of dollar exchange in neutral countries and caused a discount in certain markets, with no remedy apparent

THE BANK OF CHOSEN

Incorporated by Special Charter of Imperial Japanese Government

(\$.50 — 1 Yen)
Subscribed Capital, Yen 20,000,000

Paid-Up Capital, Yen 12,500,000

Head Office, Seoul, Korea

Principal Branches:

KOREA: Chemulpo, Pyongyang, Wonsan, Fusan

MANCHURIA: Mukden, Dairen, Changchun, Newchwang, Harbin, Antung

JAPAN: Tokyo, Osaka, Kobe

Affiliated Bank:

VLADIVOSTOK: Matsuda Bank

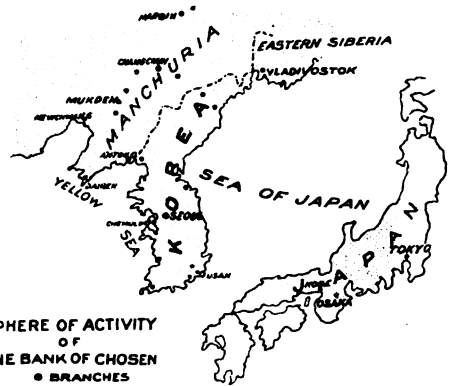

Principal American Correspondents:

Guaranty Trust Company of New York
Irving National Bank, New York
National City Bank of New York
National Bank of Commerce in New York

Yokohama Specie Bank, New York and San Francisco
Canadian Bank of Commerce, San Francisco and Seattle

at the present time. Internationally, the American dollar has, however, been climbing to a premium except in isolated cases where trade and other conditions have proven factors to the contrary.

There must not be overlooked the fact that world-wide trade and finance are in an abnormal state and it does not seem opportune nor practicable at the present time to permit the forcing of an issue when dealing with countries where trade balances cannot be liquidated along feasible lines.

If we take the condition now existing in Spain as an example we find that the United States dollar is normally quoted at \$19.20 for each pesetas 100—as against the prevailing rate of \$23.00. Due to this rise in exchange there is clearly demonstrated a disadvantage to the American merchant when trading with that country; however, this is a situation which cannot readily be remedied when the shipment of gold is obviously restricted.

For the moment the Swiss money has a value on exchange better than the legal parity in all other countries. Measured by its currency the United States dollar is at at 8 to 8½ per cent discount. In Christiania, Copenhagen and Stockholm we find a range of 10 to 15 cents below par, a decline of 5 cents in Holland and about seventeen per cent. in our exchange at Madrid.

Russian roubles at 15 cents represent a depreciation of approximately seventy-one per cent. from the normal quotation in our markets for that exchange, and while this condition may seem alarming, a very healthy rebound may be expected at any moment with the helpful influence of political and military governments in that republic. Russia is an undeveloped country, very rich in natural resources, although as yet in its infancy as regards most of her industries. Gold shipments to Japan would appear of great value both as affecting exchange rates and assisting Russia in her purchase of mate-

rials, without the necessity of delay for negotiations abroad under her own credits.

In India the silver rupee is now at a premium over gold and the British Government will no doubt soon be obliged to change the mint parity of 15 rupees to the pound sterling, although the difference as yet is only about $2\frac{3}{4}$ per cent.

London exchange on the other hand has kept fairly steady, although shortly after the war the pound sterling declined to its low level of \$4.50 without a ready market here for its sale even at that depreciated figure, but it may be stated that the principal reason for its present maintenance around \$4.76 is mainly due to the large credits granted to England by the United States Government. The arbitrarily sustained basis for this exchange has, as stated before, exercised a tendency to militate against the value of other European exchanges in our markets and against the American dollar in European centers.

It would appear that the difficulties with which we are confronted in this direction rest for solution not alone with the banker, but principally with the merchant who may have anticipated the new order of things by consummating commercial operations in United States dollars with countries where there is little or no reciprocal trading, instead of accepting an as yet unaltered situation for financing in pounds sterling or francs, payable in London or Paris as the case may be.

It would seem most effective to centralize American credits abroad through a foreign exchange bureau—to stabilize and prevent sudden erratic fluctuations of exchange quotations by reason of a momentary flooding of the market with bills. One of the duties of this bureau should be that of encouraging neutral countries to invest in securities of those nations where their trade balances for one reason or another are not otherwise readily adjusted.

COMMERCIAL EDUCATION

The general prosperity of foreign trade expansion can only be guaranteed

by a ready coördination in all elements of our national and commercial strength. There is no more important national move than that which aims to make scientific study directly applicable to practical life, and to this it would seem that our first thought should be directed.

There is a very general acknowledgment that education is as essential to business as it is to other departments in life, and viewing the subject from that standpoint it becomes apparent that a necessity exists for training our young element in the early stages of their development for business and labors which devolve upon them when at manhood they enter upon an active career.

The business world to-day is vitally interested in this problem for no organization can succeed in a material degree whose workers are not efficient. The foundation of national prosperity clearly rests upon the result accomplished by its people to serve real purposes in sympathy with current industry, science and government. If we can encourage early, direct business training, the usefulness of the populace of our country will assure both trading power and wealth.

The interest shown by our younger element in any subject pertinent to foreign trade, forcefully reveals the necessity of educational preparation especially for the teaching of commercial languages of the world and above all for the study of business fundamentals. Such training would have far-reaching consequences and give to our rising young men not only superiority as a means to augment the value of their work to those who purchase it, but the capacity for conciliation in national and international affairs.

The Educational Conference on Foreign Service Training which was called by the Commissioner of Education at Washington, December 31, 1915, resulted in the appointment of a committee of fifteen to study the question of educational preparation for foreign service in secondary schools, colleges and universities in the United States and other commercial nations.

At these meetings attention was di-

The Union Bank of Manchester, Limited

Head Office
17 York St., Manchester, Eng.

Liverpool Office
45 Castle St., Liverpool, Eng.

and branches covering the whole of the district tributary to these two cities, and also WEST YORKSHIRE; including SHEFFIELD, BRADFORD, SALFORD, BIRKEN-HEAD, OLDHAM, BOLTON, BURY, ROCHDALE, STOCKPORT, HALIFAX (ENG.), HUDDERSFIELD, etc., etc.

	(\$5=£)
Nominal Capital	\$12,500,000
Paid-up Capital	2,750,000
Reserve Capital	3,500,000
Subscribed Capital	6,250,000
Reserves	1,903,470
Surplus over Liabilities	8,153,470

Bankers in the United States and Canada are invited to make use of the Bank's services for all kinds of banking business in the district where the Bank operates, and in Great Britain generally. Collections promptly dealt with, and proceeds remitted by draft or cable transfer on New York, or as desired. Favourable terms.

rected to the lack of common thinking among business men and educators as to the trade needs and school opportunities. The committee is now at work and is especially devoting its energies towards recommending a course of study on subjects relating to:

1. International maritime and commercial law.
2. Political and commercial geography.
3. Arithmetic.
4. Modern languages, such as French, German or Spanish.
5. Natural, industrial and commercial resources and commerce of the United States.
6. Political economy.
7. American history, government and institutions.
8. Modern history (since 1850) of Europe, South America and the Far East.

The committee has under investigation the present status of study courses

in schools and commercial institutions and are comparing previous investigations that have been made in regard to the needs and opportunities of preparation for foreign service.

It is planned to study this training as given in the leading commercial nations in so far as it will prove helpful in determining a course of studies for the schools and colleges of the United States to pursue in the establishment of classes leading to a career abroad in the service of government or business.

After a careful study of the question in all its relations to business education and government has been undertaken, recommendations will be offered to the Commissioner of Education and Government for specific courses of study best suited to the different types of grades and schools.

Every coöperation and support should be given the commission to facilitate the work before them that the best results may be attained in the constructive activities for commercial education which

is of such paramount importance towards promoting our international relations.

The war in which so large a portion of the world is now engaged must sooner or later come to an end, and no matter what the determining factors may be, it is certain that far-reaching changes in the world's business are to ensue, but it seems a foregone conclusion that it will be the beginning of a great prosperity for this country.

Our nation is in need of the fullest coöperation of all its interests to work for a clearer understanding and a truer appreciation of the responsibilities of business towards the well-being of its people.

While it is probable that after the war this country will start less handicapped commercially and financially than any other nation in the world, if we are to retain this advantage and improve it, by no other means can it be than making ourselves more efficient—introducing into practice new and improved methods and by providing the elasticity and security in credit necessary to the most successful conduct of our business affairs.



Russian and English Bank

AN idea of the progress made by the Russian and English Bank may be had from the following figures showing the turnover of current and deposit accounts in the years named, the amounts being stated in roubles:

1913	75,982,954
1914	199,582,367
1915	273,575,115
1916	583,547,024

In the last year covered by the report (1916) current accounts and fixed deposits increased sixty per cent. over the figures for 1915.

The net profit of the bank for 1916, including the London branch, amounted to 3,096,528 roubles, compared with 1,723,527 roubles for 1915.

Operations of the London branch have developed satisfactorily, deposit

accounts at the close of 1916 standing at over 5,000,000 roubles (at parity of gold), and by April 1, 1917, these deposits had advanced to more than 7,000,000 roubles. This branch has taken a very active part in the sale of Russian war loans abroad.

For the year 1916 net profits were 3,096,528 roubles, out of which a dividend at the rate of eight per cent. and a supplementary dividend of four per cent. were paid and the remainder distributed to the reserve fund and various other accounts.

Among the prominent items appearing in the balance-sheet on January 31 are (in roubles): Capital, 15,000,000; reserve capital, 2,818,712; reserve dividend, 600,000; reserve for possible losses, set aside in 1914, 200,000; current accounts, 42,774,130; fixed deposits, 4,184,238; deposits payable at call, 1,844,666; cash in hand, 3,546,061. Total of the balance-sheet, 98,421,233.

Besides the head office at Petrograd and the branch at London, there is also a branch at Moscow.

The administration of the bank is composed as follows: Council—Count A. A. Bobrinsky, president; M. A. Warschavsky, vice-president; Lord Balfour of Burleigh; Sir J. M. H. Amory, Bart.; Prince A. D. Golitzin, Prince M. L. Obolensky, N. J. Djumailo, W. R. Idelson; board of directors—G. Genenson, chairman; C. G. Schkliaver, vice-chairman; H. Guedalla, Hon. F. Cripps, M. S. Mavrogordato.



American Capital in Rand Gold Mines

WHAT is regarded as an important development in international finance is the reported purchase of a substantial interest in the South African gold mines by a group of New York capitalists. As a means of obtaining such an interest the Anglo-American Corporation, Ltd., of South Africa, has been formed with an initial capital of

Leu & Co.'s Bank, Limited

Zurich, Switzerland

FOUNDED 1755



Capital Fully Paid Up } Frs. 46,000,000
and Reserve Fund }

Every description of Banking and Foreign Exchange business transacted.

Drafts and Letters of Credit issued payable in all parts of the world.

Telegraphic Transfers Effected.

Booking and Travel Department.

This bank is thoroughly equipped for handling business between the United States, Switzerland and other European countries.

LONDON AGENTS: London and Southwestern Bank, Ltd.; Credito Italiano; Swiss Bankverein.

Agents and Correspondents in all parts of the World

MANAGERS

CHAS. J. BRUPBACHER

H. DIETLER

R. G. BINDSCHEDLER

£1,000,000, which will likely be doubled at an early date.

The new enterprise, recently incorporated under the laws of the Union of South Africa, has just completed its organization by electing the following directors: Ernest Oppenheimer, chairman; Hugh Crawford and Henry C. Hull, all of South Africa, and Charles H. Sabin, William B. Thompson and William L. Honnold, of New York. Messrs. Oppenheimer and Honnold are permanent directors.

One of the objects of the new company is the opening of certain important new areas of government mining ground surrounding and operating mines of the Rand selection group.

The mines controlled by the Consolidated Mines Selection Company, with which the new company is affiliated, represent a valuation on the basis of present market prices of over \$60,000,000. Under the arrangements entered into, the Consolidated Mines Selection Company and interests identified with

it will provide one-half of the new capital called for, and the Anglo-American Corporation the balance. In other words, the two companies will operate on a basis of complete equality, as indicated by the constitution of the board, which will be made up one-half American and the rest British interests.

The new company has already acquired large interests in operating mines of the Mines Selection group, and contemplates taking a leading part in future financial activities of South Africa.

The board is an exceptionally strong one, and consists of Ernest Oppenheimer, chairman, and W. L. Honnold (these two are permanent directors) the Hon. H. Crawford chairman of the National Bank of South Africa; the Hon. H. C. Hull, a solicitor, and once Union Minister of Finance; Charles H. Sabin, president of the Guaranty Trust Company of New York, and Boyce Thompson. From the names of the American directors it is inferred that

the Morgan interests are behind the undertaking.



Royal Bank of Australia

THERE has just come to hand the fifty-eighth report of this bank, presented to the shareholders at the ordinary general meeting on April 27, held at the head office, Melbourne.

This report shows that the profits for the preceding half-year, after providing for a bonus to the staff, were £22,164. Out of this sum a dividend was paid at the rate of eight per cent, and £10,000 was transferred to reserve fund, making the total of this item £270,000, the remainder being added to the amount carried forward from last balance.

The Royal Bank of Australia, Ltd., has an authorized capital of £2,400,000, of which one-half is subscribed and £300,000 paid up. Hugh Thurburn Wilson is general manager, and A. Adamson Laing, sub-manager. In addition to the head office at Melbourne, there are branches at Sydney and Perth and several other points in Australia. The London branch is at 18 Bishops-gate, E. C., and of this branch H. Le M. Latreille is manager.

At the date of the report referred to the aggregate of the bank's balance-sheet was £3,884,956.



Australasian Banking Conditions

FROM the "Australasian Insurance and Banking Record" the following facts are obtained:

Owing principally to the prolongation of the wool season under the appraisal scheme, a substantial amount of the proceeds of the wool clip passed into the hands of the producing classes at a much later period than usual, and the result has been

that the increase in deposits which as a rule is practically completed by the end of the March quarter has on the present occasion gone into the June quarter. Comparing the June figures with those for the March quarter, deposits in the ordinary banks show an increase of £6,997,217 in Australia, and £2,982,346 in New Zealand, making a total increase of £9,979,563 for the quarter. This large increase in deposits is accompanied by a net decrease of £5,431,743 in advances, Australia showing a decrease of £5,826,980, but New Zealand an increase of £395,237. The effect of the increase in deposits and the decrease in advances during the quarter is in favor of banking resources to the extent of £15,411,306. A comparison of the movements for the quarter shown by the ordinary banks with the movements during the corresponding quarter of 1916 and 1915 is as follows:

MOVEMENTS FOR JUNE QUARTER (ORDINARY BANKS)			
	1915.	1916.	1917.
	£	£	£
AUSTRALIA.			
Deposits—			
Not bearing interest	+3,069,219	—1,300,529	+5,475,519
Bearing interest	+2,150,357	+531,769	+1,521,698
Total	+5,219,576	—768,760	+6,997,217
Advances	—1,838,635	+5,671,714	—5,826,980
Net movement as regards banking resources.	+7,058,211	—6,440,474	+12,824,197
NEW ZEALAND, 1915.		1916.	1917.
	£	£	£
Deposit			
Not bearing interest	+1,477,648	+1,450,800	+2,410,295
Bearing interest	+156,804	+942,657	+572,051
Total	+1,634,452	+2,393,457	+2,982,346
Advances	—359,861	+790,454	+395,237
Net movement as regards banking resources.	+1,994,313	+1,603,403	+2,587,109

Both in Australia and New Zealand the increase in deposits during the past quarter has been chiefly in current accounts.

Comparing the figures with twelve months ago, the movements shown are of considerable importance, an increase of £8,992,784 in the total deposits of the ordinary banks being accompanied

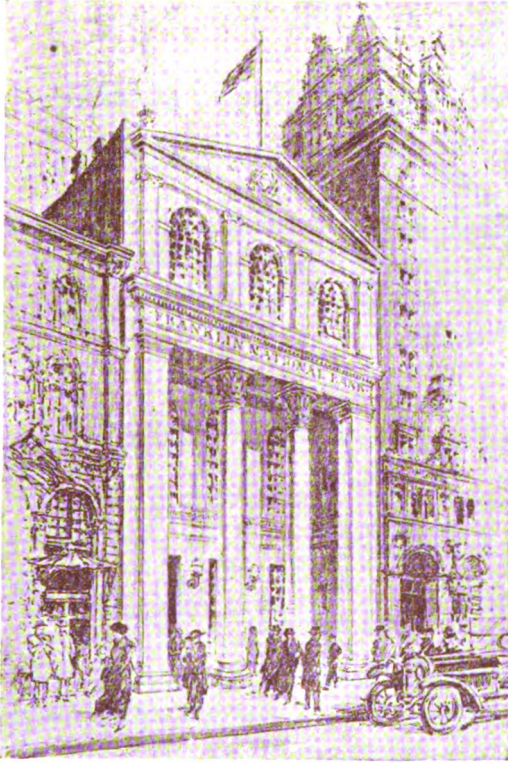

Chestnut Street west of Broad

ORGANIZED in 1900,
The Franklin National
Bank of Philadelphia
has capital of one million
dollars, surplus and profits
of over three and three
quarter million dollars,
and total resources of over
sixty million dollars—
a record of growth, sub-
stantial and unequalled.



UNION *National Bank* OF CLEVELAND

In our new building with modern equipment we are better prepared to render good service to our friends.

*“Expeditions Service now—
Long Experience taught Us How”*

WARREN S. HAYDEN, Chairman of the Board

GEORGE A. COULTON, President

WILLIAM E. WARD, Vice-President

FRED. W. COOK, Asst. Cashier

ELMER E. CRESWELL, Vice-President

CARL F. MEAD, Asst. Cashier

WALTER C. SAUNDERS, Cashier

HARRY E. HILLS, Asst. Cashier

FRANK A. WHITE, Asst. Cashier

DO YOU KNOW

that the first National Bank chartered in the United States was the First National Bank of Philadelphia? We are still doing business at 315 Chestnut Street and invite accounts of banks, firms, corporations, partnerships and individuals on terms commensurate with the character of the account.

OFFICERS

Wm. A. Law, President

Kenton Warne, Vice-President

Thos. W. Andrew, Cashier

Freas B. Snyder, Vice-President

Chas. H. James, Asst. Cashier

Harry J. Haas, Vice-President

Carl H. Chaffee, Asst. Cashier

Total Resources - \$41,000,000

THE FIRST NATIONAL BANK

PHILADELPHIA, PA.

BANKAKTIEBOLAGET SÖDRA SVERIGE

Head Office : HELSINGBORG, Sweden

Branches : STOCKHOLM, GOTHENBURG, MALMÖ, BORÅS and in 48 other Places in Sweden

(\$0.26 = 1 Kr.)

Capital Paid Up Kr. 30,000,000
 Surplus About Kr. 15,000,000
 Resources About Kr. 260,000,000

The organization and excellent relations of this Bank secure to its clients the most efficient handling of their business on moderate terms

Inquiries and applications for terms are cordially invited and will find prompt attention

Principal New York Correspondents { The Mechanics & Metals National Bank
 The National City Bank of New York

by a decrease of £24,252 in advances. Of the increase in deposits, more than two-thirds has been in New Zealand; while the trifling difference in advances is the net result of a decrease of about 7½ millions in Australia, and an increase of about the same amount in New Zealand. Adding the deposits of the Commonwealth Bank (exclusive of Savings Bank deposits) to those of the ordinary banks in Australia and New Zealand, the combined total is close upon 240 millions sterling, a comparison with the June quarter in previous years being as follows:

June Qr.	DEPOSITS.		
	Ordinary Banks.	Commonwealth Bank.*	Combined Total.
	£	£	£
1914 ...	183,449,001	2,501,934	185,951,025
1915 ...	192,860,101	4,572,145	197,432,246
1916 ...	198,780,544	21,537,219	220,317,763
1917 ...	207,773,328	32,181,011	239,954,339

*Not including Savings Bank Department.

While the deposits in the ordinary banks in Australia and New Zealand show an increase of £8,992,784 during the past year, those of the Commonwealth Bank show an increase of £10,643,792, a movement reflecting the influence of Australian Government borrowings in absorbing a large proportion of fresh accumulations for war purposes. Since 1914 the deposits in the ordinary banks have increased by over 24 millions.



Queensland National Bank

FOR the half-year ended June 30 this bank showed gross profits of £131,939, and after deducting expenses

of the head office and eighty-three branches, there remained a balance of £51,895.

On June 30, 1917, the capital was £480,000; reserve fund, £222,000; profit and loss, £51,895; deposits, £7,362,826; total assets, £11,692,406.

The head office of the Queensland National Bank is at Brisbane, and a London office is maintained at 8 Princes street. There are numerous Australian branches, with agents and correspondents throughout the world.



A Banking Development

REFERRING to the formation of Lloyds Bank to operate in France, the London "Statist" of September 22 says:

"A further development in the extension of banking interests of Great Britain in other countries is announced. The initial movement in this direction was taken about six years ago, when Lloyds Bank extended their activities to France, and as a nucleus acquired the business of Messrs. Armstrong & Co., of Paris and Havre. For this purpose an auxiliary institution called Lloyds Bank (France), Limited, was formed with a nominal capital of £250,000 in £50 shares, of which £20 was paid up. The business of the French subsidiary soon developed, its nominal capital was subsequently increased to £600,000, and several more offices were opened. Other British banks which have since followed a similar procedure

MERCANTILE BANKING COMPANY, Ltd.

Avenida Francisco I. Madero No. 12

CITY OF MEXICO, D. F.

Capital and Surplus, \$600,000.00

GEO. J. McCARTY. K. M. VAN ZANDT, Jr., H. C. HEAD, FCO. COUDURIER,
President Vice-President and Manager Cashier Asst. Cashier

Members: American Bankers' Association, Texas Bankers' Association, Mexico City Clearing House

GENERAL BANKING TRANSACTED TELEGRAPHIC TRANSFERS

Foreign Exchange Unsurpassed Collection Facilities Throughout the Republic

SEND US YOUR MEXICO BUSINESS

WRITE US UPON ANY SUBJECT WHICH MAY BE OF INTEREST TO YOU IN THE
REPUBLIC OF MEXICO. P. O. Address: Apartado 1346.

by opening up in France have been the London County and Westminster, which has its own French subsidiary, and the London and South Western, which owns joint interest with Cox & Co. in Cox & Co. (France), Limited. Now it is announced the National Provincial Bank is to enter the French banking field, and in order to do so it is to share with Lloyds Bank the ownership of Lloyds Bank (France), Limited, the nominal capital of which it is proposed to increase from £600,000 to £1,200,000. The new money will be provided by the National Provincial Bank, for it is stated in the official announcement that the interests of the two banks will be equal in all respects. The new arrangement, it is believed, is to come into effect on October 1. In future the French institution will be known as "Lloyds Bank (France) and National Provincial Bank (France), Limited," and will have a separate directorate with the head office in London. The board will consist of Sir Richard V. Vassar-Smith, Bart., as chairman, and Lord Inchcape as deputy-chairman, and eight directors, four of whom represent Lloyds Bank and four the National Provincial. The offices of the bank in France are in Paris, Havre, Bordeaux, Biarritz, St. Jean de Luz, and Nice.



National Bank of India

THE National Bank of India was established in Calcutta, September 29, 1863. Its present subscribed capi-

tal is £2,000,000, of which £1,000,000 is paid up. The reserve fund is £1,250,000.

A report showing net profits for the half-year ending June 30 states that after providing for bad and doubtful debts, £143,770 remained, to which was added the amount brought forward, making the available total £250,460. Out of this the directors declared an interim dividend at the rate of sixteen per cent., amounting to £80,000, leaving a balance of £170,460 to be carried forward.

On June 30 last the deposits were £20,212,399, and the total resources £24,789,468.



Report of Western Australian Bank

THE Western Australian Bank with head offices in Perth, W. A., has a paid-up capital of £250,000 and a reserve fund of £680,000. For the half-year ended March 26, 1917, total resources amount to £3,470,723 and deposits £2,354,350. Gross profits after providing for bad and doubtful debts, etc., are £70,562.



New English Banking Company

THE British and Foreign Mercantile Bank, Limited, has been registered at Somerset House, by Herbert Smith, Goss, King, and Gregory, London Wall, E. C., with a nominal capital

of £100,000 in £5 shares. The objects for which the company is established are to carry on in the British Empire or elsewhere the business of a bank of deposit and every description of banking, mercantile, and financial business, to support British trade at home and abroad, to act as agents for procuring contracts and orders for British manufacturers, and to render financial assistance in regard thereto.



Holland To Have Tobacco Bank

THE association of tobacco importers, dealers, and brokers that undertook to guarantee to the Dutch Government that operatives in domestic tobacco factories would not be forced out of work on account of the lack of raw materials has formed a tobacco bank called the Vereenigde Nederlandsche Tabaksbank (United Dutch Tobacco Bank), for the purpose of carrying out those guaranties. The capital is fixed at 21,200,000 florins (about \$8,840,000), divided into shares of 5,000 florins (about \$2,000) each. It is stated that \$3,680,000 already has been subscribed.



Wealth of the Argentine Republic

A LECTURE on the wealth of the Argentine Republic was recently delivered by Dr. Alberto Martinez before the Instituto Popular de Conferencias at Buenos Aires. Basing his conclusions on the results of the last national census, which he had directed, he estimated the aggregate wealth of the people of Argentina at 34,260 million paper pesos, or \$14,546,796,000, as against the small sum of only \$2,740,600,000, the estimate of the 1895 census.

Spanish Bank of the River Plate

THE Banco Español del Rio de la Plata for the semi-annual period ending June 30 reports (in legal money): Capital, \$100,000,000; deposits, \$183,021,949; reserve fund, \$48,105,509; cash on hand, \$57,000,796, and \$12,591,234 in gold coin. The total of the balance-sheet on the date named was \$341,968,343.73.



Future of the United States

By WILLIAM A. LAW, PRESIDENT FIRST NATIONAL BANK, PHILADELPHIA

ANY man who takes a bearish position upon the future of the United States will be blown up through the explosion of his own ignorance.



WILLIAM A. LAW

More Liberal Treatment for Foreign Banks

IN the August issue of *THE BANKERS MAGAZINE*, under the title "Reciprocity in International Banking," the suggestion was made that in view of the extension of American banking into foreign countries it would be advisable for some of our states, and the State of New York in particular, to relax somewhat the present laws relating to branches and agencies of foreign banks. Such agencies and branches are prohibited from carrying on a discount and deposit business, and it was proposed that they be granted this privilege, under proper safeguards.

Managers and agents of several important banks were asked to state their views on the subject, for publication. Some of their replies are printed herewith, and others will follow.

CLOSER FINANCIAL RELATIONS BETWEEN ENGLISH-SPEAKING COUNTRIES

By **GEORGE WILSON,**

New York Agent Union Bank of
Canada

YOUR recent article on "Reciprocity in International Banking" is thoroughly in keeping with the spirit of the times. Prior to the war, international diplomacy, politics and finance were characterized by the policy of "splendid isolation," but since the exposure of Teuton trickery and duplicity, the old order of things has given place to coördination and coöperation in diplomacy, and in the activities of the naval, military and economic forces of the Allied nations; and just as this policy of absolute coöperation is essential in the winning of the war, so must there be coöperation in the financial policy of the Allies if the fruits of victory are to be firmly established.

The two great English-speaking peoples are undoubtedly destined to be the strongest factor in world politics after the war, and the closer Great Britain and America can be brought together in international commerce and finance, the better. Up to the outbreak of war, the United States was so absorbed in the development of trade within its own gates that its foreign-trade policy was more or less neglected, but the United States has since learned to think internationally, and after the war its mercantile flag will undoubtedly be prominent on the seven seas and its trading posts established in the uttermost parts of the earth. As an auxiliary in the forthcoming expansion of its foreign trade, the financial lines of the United States must also be properly cast, and there is little doubt that the policy which now imposes onerous restrictions upon foreign banking institutions operating in this country should be ameliorated or removed if the United States

is to take its proper place as an overseas trader.

The Federal Reserve System, which is designed upon broad lines for the



GEORGE WILSON
Agent Union Bank of Canada, New York

development of internal and external trade, will doubtless become a strong factor in the amelioration of these unsatisfactory conditions. Absolute freedom of operation is accorded to all foreign banks established in London, and to this policy can be largely ascribed London's supremacy as the world's financial centre. Moderate discrimination against foreign institutions is natural and to be expected, but impediments should not be imposed to the extent of comparative strangulation. After the war, there will be a closely working financial partnership between London and New York, but this cannot be developed to maximum efficiency until restrictions now imposed upon foreign banking corporations in this country are materially moderated.

CONCERTED ACTION SUGGESTED

By K. I. IMANISHI,

Manager New York Agency Bank of Taiwan, Ltd.

THANK you very much for a request for expression of my views as to a modification of the restrictions contained in the New York State Banking Laws in regard to the operations of branches or agencies of foreign banks.

Permit me to say that in my opinion the proposal made in your article in THE BANKERS MAGAZINE, "Reciprocity in International Banking," is exactly what could be accomplished.

I believe also that the removal of the



K. I. IMANISHI
Manager New York Agency Bank of Taiwan, Ltd.

restrictions in question are desirable at this time. When New York's importance as a financial centre was not so great as it now is, and when the banks here were engaged in building up their

business to its existing magnitude, such a restrictive policy was no doubt wise. But now the situation has changed, as I need not tell you. The New York banks have nothing to fear from such competition as would ensue after a removal of this restriction, and as a matter of fact such competition—for reasons which you have admirably stated—would be slight. On the other hand,

by allowing the foreign banks reasonable freedom of operation, I feel sure that the general financial prestige of New York would be increased and in this gain all the banks would share.

It is my opinion that if all the foreign banks combined forces and endeavored to have the banking act modified, it might be the means of wiping out these restrictions.



Japan and the United States

By VISCOUNT K. ISHII, SPECIAL AMBASSADOR FROM JAPAN

WE have been friends for some fifty years. We propose to strengthen that friendship. We have earned a right to it by the true history of the past and we propose to hold it through all the years that are to come,

for we value it far too highly to risk its loss. In these fifty years of great development for you and for us we have met in the market place, and, as time went by, the understanding grew. We have tasted of your gracious hospitality on other occasions. We have learned from you the ways of the West and of the Street; but, sir, those were different times and different inducements. Hitherto we have come to you, as you have come to us, with something to sell or something to buy; something to give and something to take. Hitherto it has been the cry that trade and commerce, exchange and mart would bring us to a better understanding, and it has; but to-day there is something more—East meets West on common ground. "That Royal Hawk, the sun, has flown from the Orient's hand and lighted in the West." The same sun glorifies the stars and is blazoned on the snow white fields of "your flag and my flag as they fly to-day; on your land and my land half a world away." This is the day of the gathering of the clans of the East and of the West. The day has dawned in which the yesterday is forgotten; when old prejudices, old misunderstandings fade and you greet us as we greet you—old friends and new made brothers in the struggle for human liberty, human freedom and national existence.



VISCOUNT ISHII

The Distinguished Head of the Imperial Japanese Commission, now in the United States

How Bankers Are Doing Their Bit

FROM far-off Australia come some interesting stories of how the banks of that country are "carrying on" and helping with "men and millions" to win the war for democracy. One of the splendid things about the war is the whole-hearted support of the mother country by these far-distant colonies.

COMMONWEALTH BANK

Under date of Aug. 20, Denison Miller, governor, writes:

"Since the outbreak of the war, leave of absence has been granted and positions kept open for over 150 male officers of this bank who have volunteered for service abroad with the Australian Imperial Expeditionary Forces

"Of this number twenty-two have gained commissions, holding various ranks up to lieutenant-colonel.

"One of these has been made a Companion of the Most Distinguished Order of the Bath, another a Companion of the Distinguished Service Order, two have won the Military Cross, one of these latter having also been awarded the Distinguished Conduct Medal, while

we regret to say that four have been killed.

"Of the non-commissioned officers and men, nine have been discharged as unfit for further military service, seven of whom have returned to bank duty, while we regret to say that six have given their lives, making a total of ten members of the bank's staff who have made the supreme sacrifice.

"The officers of the bank who enlisted immediately on the outbreak of war are being paid full bank salary in addition to their military pay. Those who enlisted later are being paid half bank salary in addition to military pay, if they were members of the bank's staff at the outbreak of war, while as regards officers joining the staff since the beginning of the war, each case is dealt with on its merits.

"All the members of the staff on active service participated in a special bonus granted to the staff when the new head office premises of the bank were opened in August, 1916.

"The bank's officers have contributed largely to the various commonwealth war loans, and they have assisted in



Commonwealth Bank of Australia Branch Office at Liverpool Depot, A. I. F., Liverpool, New South Wales, October, 1916

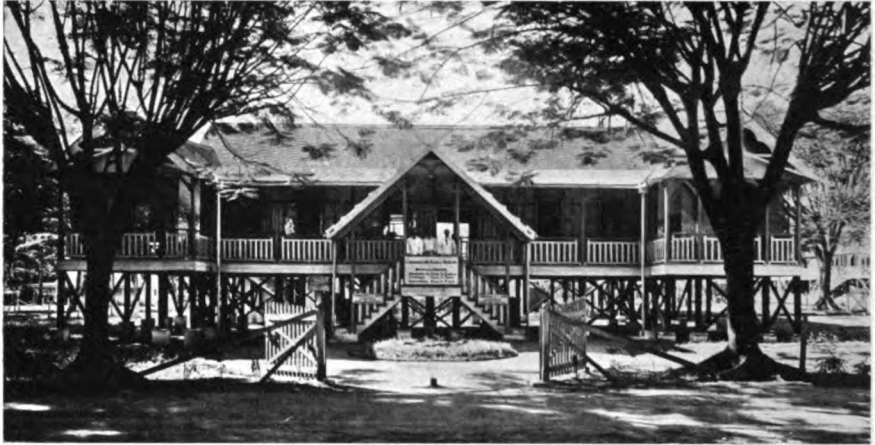

Rabaul (New Britain) Branch, Commonwealth Bank of Australia, April, 1916

connection with various patriotic collections made from time to time. On these occasions as many as 100 of the bank's officers have given voluntary help with the receiving and counting of the proceeds.

"War savings groups have been organized, and regular amounts are being collected and applied in the purchase of war savings certificates.

"For some considerable time past the bank has not considered applications for appointment from men between 21 and 45 years of age, unless they are returned soldiers. Preference is given to returned soldiers with banking experience, and, apart from these, only girls

and boys under 21 years of age are being taken on the staff.

"The bank is conducting the whole of the banking business of the Commonwealth Government, including naval and military departments, the issue and management of all war loans and war savings certificates and other matters connected with the war.

"Banking facilities have been provided at all military camps, not only in Australia, but in England and Egypt and wherever Australian soldiers are congregated. Fully equipped branches of the bank have been established at the principal centres.

"Special arrangements have been



Australian Light Horse, Liverpool Depot Savings Bank Agency, Commonwealth Bank of Australia, Liverpool, N. S. W.

made whereby soldiers may open accounts in the savings bank department, and have a portion of their fortnightly pay credited to their accounts. Interest is allowed on these deposits from date of receipt, and the money is made available at London, or such other convenient place as may be arranged from time to time, free of exchange. Arrangements have also been made for soldiers to exchange Australian notes and silver

additional accommodation, and arrangements have now been completed to open a new branch occupying the whole of the ground floor of 'Australia House' in the Strand, specially to cater to the requirements of Australian soldiers. A branch has also been opened at the centre of the Australian military camps in England at Tidworth, Salisbury Plain, which has been of considerable convenience to the soldiers in camp. All services rendered for members of the Australian Imperial force are conducted without charge by the bank.

"After the capture and occupation of German New Guinea by the commonwealth forces, a branch of the bank was established at Rabaul for the convenience of the administrator and the forces in occupation, as well as for the conduct of the whole of the banking business of the possession."

Photographs of some of the camp branches accompany the letter, and are shown herewith.



Savings Bank Agency, Commonwealth Bank of Australia, Liverpool (N. S. W.) Depot., A. I. F., April, 1915

for English currency at par at the principal banks in London, France, Egypt, Ceylon, South Africa and other places.

"The facilities provided by the bank for soldiers have made great demands on our London branch, and it has been necessary to engage 150 female clerks and also to send experienced officers—over the military age—from Australia, to cope with the volume of business being handled for the Australian Imperial forces.

"The number of soldiers availing themselves of these facilities has increased to such an extent that it has been found necessary to still further augment the staff and also to obtain ad-

BANK OF AUSTRALASIA

C. J. Henderson, superintendent, writes under date of August 14:

"In reply to your inquiry, the following information as to what the Bank of Australasia is doing in Australia and New Zealand may be of interest:

"Members of the staff who enlist are granted leave of absence from the bank on half-pay, irrespective of military pay. Where, however, this would leave a shortage in salary, more than half-pay is granted so as to bring military pay up to full bank pay. All bank officers who desire to return to the bank's service after the war will be taken back. Full pension rights are preserved in the bank's guarantee and provident funds to those who go to the front.

"When bank officers return to duty, after being discharged on account of physical unfitness, every endeavor is made to meet their convenience. For example, an officer suffering from, say, rheumatism contracted abroad is where possible, attached to a health resort branch where he can have the advantage

of mineral baths, etc. It is recognized that no bank officer should suffer financial loss through fighting for his country.

"Over 350 members of our Australian and New Zealand staff have gone to the front, besides many from our London office, of which numbers I am not advised. Of the former thirty-six have unfortunately, up to the present, been killed, while a large number have been wounded.

"With such a large number away fighting a very heavy strain is thrown on the remaining staff, who have loyally and cheerfully undertaken extra duties. Raw youths and female clerks have been admitted temporarily to fill the vacancies, but this of course means that more supervising is thrown on the executive staff.

"Returns furnished by branches to head offices are being cut down in every possible way in order to reduce work."

BANK OF ADELAIDE

John Shiels, manager, states that sixty-four members of this bank's colonial staff and twenty-four of its London staff have enlisted since the beginning of the war; seventy-six are still serving with the Imperial forces, nine having been killed, one captured by the enemy and two discharged incapacitated.

The bank grants the men leave of absence during the term of their military service, reinstating them without loss of grade on their returning to duty. If their military pay be less than their bank salary the bank pays them the difference, so that they are not at a disadvantage by serving their country.

NATIONAL BANK OF AUSTRALASIA, LTD.

The National Bank of Australasia, Limited, whose head office is at Melbourne, Victoria, and which has 170 branches and sixty agencies scattered through Australia, and an office in London, with a staff of 851, of which 161 are women, has done its utmost to encourage its officers to serve the colors. It keeps their bank positions open dur-

ing their absence on war service; makes up any shortage between their military emoluments and bank salaries, and grants periodical increments in salaries during their absence on service.

Practically every eligible officer, who can be spared, has enlisted for active service and the present total is 342. In



LIEUTENANT RUPERT THEO. VANCE MOON
of the Staff of the National Bank of Australasia,
awarded the Victoria Cross

The honour was conferred for conspicuous bravery in leading a successful attack on a strong position held by the enemy on the Western front in France, during which he was four times wounded and only consented to relinquish his post after the fourth severe wound. His bravery has been described as magnificent and was largely instrumental in securing a victorious issue against superior numbers of the enemy with the capture of many prisoners and machine guns.

one Australian state (Western Australia) every unmarried eligible officer of this bank has offered himself for enlistment. Many of the bank's officers have gained commissioned rank, and amongst the honors won by them, up to time of writing (August 29), are included a V. C.—(the first won by a bank officer from Australia—a D. S. O., three Military Crosses, two Military Medals (one officer has won both the Military Medal

and Military Cross), D. C. M., M. S. C., and others have been Mentioned in Despatches. A lady clerk, acting as a Red Cross ambulance driver, suffered severe injuries in the discharge of her duty and gained the French Military Cross, with a Star. Thirty-seven have made the supreme sacrifice, fifty-four have been wounded, seven are reported missing, and two are known to be prisoners of war.

The names of enlisted officers are enrolled on a magnificent roll of honor, the original of which is hung in the entrance vestibule at the head office of the bank, and a replica exhibited at each branch of the bank.

Those officers still remaining on bank duty, by personal subscription, enable parcels of literature, comforts and luxuries to be sent to their colleagues on the battlefields, and by means of a pamphlet of chatty jottings regarding mutual friends and service happenings, keep them in touch with local interests and evidences that though absent they are not forgotten.

To meet the special monetary pressure due to the war, the bank has granted its lower salaried married officers a special war allowance to supplement their salaries.

The bank has afforded and continues to afford many services to the government. It has liberally contributed to each successive war loan, and assisted in the finance of the (Government's) wool and wheat realization schemes. Its numerous branch offices sell war savings certificates; receive and forward applications for war loan bonds and remit moneys therefor to the capital cities, free from any charge for service or exchange; and receives for safe custody from any member of the public war savings certificates and bonds, without fee.

LONDON BANK OF AUSTRALIA, LTD.

Of this bank's staff, 106 have enlisted and of these thirteen have been killed in action. To assist in the work seventy-five girl clerks have been employed by the bank. The directors encouraged enlistment by paying full salaries, for



A member of the Staff of the National Bank of Australasia, awarded the French Military Cross, with a Star. She suffered severe injuries while discharging her duties as an Ambulance Driver

six months, to those who enlisted, half-salaries afterwards. All positions of officers enlisting are kept for them on their return from active service.

STATE SAVINGS BANK OF VICTORIA

The commissioners of the State Savings Bank of Victoria have encouraged all their officers to enlist for active service, and out of a staff of 517 officers when war commenced, 240 have joined the Australian Imperial forces. All officers receive full pay from the bank for the first three months, and then half-pay until the agreements terminate; this is in addition to the pay allowed by the Defence authorities. Every officer on his return or discharge can resume duty, and his salary will be increased by the increments granted during his absence, but unfortunately all will not be able to

resume, as the bank has already lost by death twenty-five men, and four are missing.

COMMERCIAL BANK OF AUSTRALIA, LTD.

Two hundred and thirty members of the Commercial Bank staff have enlisted for active service, and twenty-two have been reported killed or missing.

The bank has arranged to keep positions open for all who return, and meanwhile if their military pay is less than the amount of their salary at date of enlistment, the difference is made good by the bank.



Alaska, too, is doing its bit. W. L. Landsborough, cashier of the Bank of Alaska, writes under date of October 4:

"Your letter concerning the department in your *MAGAZINE* and relative to the part the American bankers are to play in the great war, is very interesting.

"Dr. J. T. Westermann, vice-president of the Bank of Alaska, and formerly in charge of our Anchorage branch, has joined the Second Reserve Officers' School at the Presidio, San Francisco.

"Dr. Westermann was one of the twenty-two applicants from Alaska. He is a man of considerable military training and holds a commission as captain in the New York State Militia."

AMERICA THE BULWARK OF LIBERTY

In July there was printed in this department a little poem, "Freedom Here to Stay," by L. F. Spencer, cashier of the First National Bank of Ridgewood, N. J. During the lull between activities incident to obtaining subscriptions to the first Liberty Loan and preparations for the next one, the Spirit of Liberty stimulated Mr. Spencer to put America's record on freedom and liberty in a little stronger language as reproduced here:

AMERICA, THE BULWARK OF LIBERTY

By Lucius Foote Spencer

America, fair land of hope,
Where Liberty was born,
Thy shores unfalling refuge give
The storm-tossed and forlorn
While loving peace, we've had our wars,
But never to oppress.
Our sword has ever proved itself
A succor in distress.

Our fathers with George Washington
Resisted George the King,
And thus won freedom for themselves
But there remained a sting.
A grievous toll of blood it took,
And Lincoln's potent pen,
To purge that bane of slavery
And leave us all free men.

Again our trusty sword is drawn
That Liberty may live:
The world is calling, and we go,
Our best and all to give.
With patient hope we strove in vain
To stay the scourge of war,
But murder, outrage, broken faith
Have banished peace afar.

Our foe, the modern Hun, unvelled,
Defiant stands to-day:
Scorning all rights that lack the might
To thwart him in his way.
America! beloved land!
Thy past marks no defeat.
May God again thy valor crown
With victory complete.



"Utility Letters of Credit in the Export Trade—A Plea for Standard Forms"

THIS is the title of a new pamphlet issued by the American Steel Export Company of New York. The author, J. P. Beal, who is secretary and assistant treasurer of this company, makes recommendations of interest to

the American banker and exporter. He has indicated a point of weakness which might be improved materially, a point which to him seems worthy of immediate attention, to the betterment of our entire overseas financial facilities.

Seven Principles of Courtesy

COURTESY as a business asset has been a principle much talked about of late. It has been recognized by many large corporations whose employees come in constant contact with the public as something to be demanded and not recommended. One large company, the United Cigar Stores, makes it an inviolable rule that every purchase shall be recognized with a verbal "Thank you."

But courtesy isn't something that can be clubbed into a reluctant misanthrope. You can't stand over a man with a gun and demand courtesy. True courtesy must come from the heart—not from the fear of being fired. It's one thing to set up a sign in your bank, "This bank demands courtesy from all its employees," and it's quite another to create in their hearts a spirit of loyalty to their institution and of interest in its clients which will make them naturally courteous at all times.

The Cleveland Trust Company is to be congratulated upon its practical recognition of the value of courtesy in its relations with its clients. This has resulted in the appointment of a "courtesy committee," which holds regular meetings to discuss ways and means of encouraging and fostering a spirit of good feeling between the bank and its customers.

At the first meeting, the committee adopted seven principles of courtesy which it believes to be fundamental. These principles were brought to the attention of all employees and recommended "for careful study and intelligent practice." Believing that they will be of interest to readers of *THE BANKERS MAGAZINE* we reproduce them as follows:

1. **RECOGNITION.** Nothing makes a customer feel easier and more at home than the immediate and courteous recognition of his presence. You may be very busy, when some one steps up to your

window, but no matter how busy you are, true courtesy dictates that you shall immediately recognize the presence of your customer by a nod or a smile or a spoken greeting, followed by some statement as to when you can give him attention; if there is a line at the window, you can keep everybody in sight in good order by showing them the kind of recognition that means that you will take care of them as soon as possible.

The committee puts the principle of Recognition first because it is the first point of contact and applies with equal force to the opening of every possible transaction with the bank at every window, at every branch, and at every officer's desk. It is, therefore, the commonest, most frequently violated, and at the same time most important principle for you to remember and act upon. The precise way of acting upon it is largely a question of your personality; and it will be discussed at further length at a later time. In the meantime, remember your obligation to recognize people with whom you are about to do business.

2. **EXPLANATION.** The second principle of courtesy may be stated in two words: Don't argue. Where you cannot agree with a patron, tell him why, explain in a quiet and courteous manner why you cannot do certain things he may require, because certain rules prevent you from doing so. Don't contradict, don't be arrogant, don't try to save time by being too brief; give your customer a reasonable and adequate explanation of your point, and this explanation will make him see that you are right; if it doesn't—still don't argue, but refer him in a courteous manner, to a superior officer.

3. **MEMORY FOR NAMES AND FACES.** There is no better business-building force than the recognition of a person by name. The ability to do this is sometimes a gift, but is always an accom-

plishment that can be cultivated. In the transaction of your official duties, the formality of an introduction can be laid aside. There is no possible chance for offense if you greet a man or a woman by name, even though you have never met in a formal way. Business is not society, and you need not hesitate to say "Good Morning, Mr. Thompson," even though you do not know Mr. Thompson except by name, and he does not know you. He is a human being, nevertheless, and will appreciate the compliment and remember it, no matter how low or high his position. Cultivate the valuable accomplishment of remembering people by name.

4. CUSTOMERS' RIGHTS. Marshall Field built an immense business largely on the theory that the customer is always right. As a matter of fact, the customer is not always right, but he always thinks he is. Open antagonism of his views will make bad feelings, even though you know you are right. Therefore, first assume that he is right, in order to find out whether it is so or not. This will give you an open view of the situation, and prove to you whether you yourself are right, or wrong. After you are sure, go back to courtesy principle No. 2, and in your best way, explain, but do not argue. From that point, you can apply principle No. 2 to the end.

5. ACCOMMODATION. There are lots of things that you are not obligated to do for people, but by doing them, you can win a recommendation and a degree of gratitude that may establish a relationship extending over years and years of time. Remember the scientific principle that you cannot do a favor for any person without doing a greater favor to yourself. These are days of strong competition, and if you are not accommodating, somebody else will be, and by being so, will either get your business or your job, or both. This is natural law. Think about the little things that you can do for people to create and maintain permanent business friendships. Remember that nobody is obligated to do business with The Cleve-

land Trust Company, excepting through the personal ties and bonds of willingness that individuals in this institution create by their own attitude toward its patrons.

6. PERSONALITY. We cannot change the color of our eyes or hair or influence to a large degree our physical appearance, but we can build a mental and spiritual personality that will offset every physical defect. Consciousness of this fact is the beginning of improvement. Under this one head all of the principles of courtesy are included. The decision to have a pleasing personality will make you think of all the possible ways of achieving the result. Imitation of some other pleasing personality is not enough; you are You, and it is right for you to be different from all other individuals, but it is also right for you to aim at a pleasing personality of your own particular kind. Careful study of the right things to say and do, and careful, scrupulous rejection of everything that is wrong, will automatically, in time, give you a pleasing personality and enlarge to a wonderful degree your possibilities for success, no matter what your occupation may be.

7. SALESMANSHIP. Although The Cleveland Trust Company has no shelves filled with merchandise and cannot weigh or measure anything tangible to sell, you must not forget that its entire business is a problem in salesmanship. A man may think he wants to open a new account with a dollar, but he may be wrong; tactful salesmanship may prove to him that he wants to open an account for \$5.00, and that he wants to come in every week afterward with a regular deposit of \$5.00. Tactful salesmanship again may prove to a woman who wants to withdraw every cent from her savings account that she ought at least to leave a dollar on deposit and retain her passbook. Tactful salesmanship may prove to a person who has borrowed all the money he can get on a mortgage that he ought to accumulate his payments against that mortgage by having a savings account. The fact that he is a borrower does not cancel the fact

that he must be a saver, in order to get out of debt. Tactful salesmanship on a customer who is doing business with one window can lead him to do business with two or more windows, all in the same building. The foundation of the entire scheme of enlargement is cour-

tesy, and courtesy as you know is nothing more than thoughtfulness.

Read this entire article over again, start to put one or more of these principles into operation at once, and every morning when you go to work, start all over again and keep at it.

Book Reviews

THE NEW BUSINESS DEPARTMENT. By T. D. MacGregor. The Bankers Publishing Co., New York. Price, \$1.00.

This little book, the second in the series of "Bank Department" handbooks to be issued by the Bankers Publishing Company, is the sixth book from the pen of this talented specialist in bank business promotion. It is undoubtedly true as the author says in his introduction, that "Notwithstanding the fact that we are now in a state of war, it still seems advisable for bankers to advertise and work for new business. In fact, there is greater need than ever before for the use of the most effective methods."

And that is just what this book aims to give in a nutshell—the most effective methods for business promotion, not only in getting new depositors and clients, but also in developing intensively those already connected with the institution. While probably there are not more than a dozen institutions in the country which are large enough to warrant the establishment or maintenance of a new business department even approximating the extent and thoroughness of that of the Guaranty Trust Co., which is described in this book, there are thousands of banks and trust companies which can learn something from the systematic and scientific methods of new business effort so clearly ex-

plained in "The New Business Department."

There are numerous incidents and illustrations dealing with the average bank and its efforts to grow which bring this book within the possible experience of every bank, no matter what its size or geographical position. The follow-up file and data given concerning one small town bank in Wisconsin, in itself is worth the price of the whole book to any earnest seeker after the right idea in business building for banks.



CREDITS AND COLLECTIONS. By R. P. Ettinger and D. E. Golieb. Prentice-Hall, Inc. Price, \$2.00.

The authors have set forth in proper detail the correct principles and practice of credit management, with special attention to mercantile credit. They have also discussed a number of practical credit problems, such as the analysis of financial statements, discounts, collections, adjustments, bankruptcy practice and credit insurance, with which the scientific credit grantor must be familiar.

In fact, every step in credit granting and collecting is exhaustively discussed both from theoretical and practical points of view.

PRACTICAL BANKING. By O. Howard Wolfe. La Salle Extension University, Chicago. Price, \$2.00.

Sets forth in a clear and simple manner the internal operations of a bank. Explains the principles of bank accounting and of the transactions that are common to the various forms of banking.

The study of practical banking should be from the bottom up—not from the top down, and the simple operations should be understood first. This is the plan adopted here.



INTERNATIONAL FINANCE. By Hartley Withers. E. P. Dutton & Co., N. Y. Price, \$1.25.

A clear, simple and thorough description of the machinery and methods of money-dealing between countries—of how foreign loans are floated, and of the connection of finance with foreign trade, diplomacy, and war.

The author is recognized as a distinguished authority on financial affairs in the London money market, and has especially prepared this volume for readers in the United States.



AN APPROACH TO BUSINESS PROBLEMS. By A. W. Shaw. Harvard University Press, Cambridge. Price, \$2.00.

The book gives a simple, uniform method for dealing with business problems, at whatever point they may arise. The method includes the elimination—or at least the recognition—of the personal factor, separating the problem into its constituent problems, listing and balancing the factors involved, and taking a fresh point of view.

With the method, the author goes through the broad fields of production, distribution, and administration, illustrating its use in scores of typical cases drawn from actual businesses.

As the average business man becomes familiar with the process, he probably

will find himself possessed of new facilities for dealing with his own problems, determining the soundness of his present practices, and shaping his policies for the future.



FEDERAL FARM LOAN SYSTEM. By Herbert Myrick. Orange Judd Co., N. Y. Price, \$1.00.

A practical manual upon organizing and conducting national farm loan associations, also joint stock land banks.

The object of the book is to aid those who desire to enjoy all of the advantages of the new Federal Farm Loan System, farmers, bankers, investors, and the public at large.

Includes the full text of the Federal Farm Loan Act.



DISTRIBUTIVE JUSTICE. By John A. Ryan. Macmillan Co., New York. Price, \$1.50.

A comprehensive discussion of the moral aspects of the distribution of wealth.

While the rights and obligations of the four classes—landowners, capitalists, business men and laborers—all of whom share in this distribution, form the main subject of the work, there are also proposed reforms that would remove the principal defects of the present system and bring about a larger measure of justice.



SECOND THOUGHTS OF AN ECONOMIST. By William Smart. Macmillan & Co., London. Price, \$1.40.

The author, the Adam Smith professor of political economy, Glasgow University, discusses the distribution of wealth and work; the responsibility of the consumer and the employer.

A biographical sketch, carefully prepared by Thomas Jones, lecturer in political economy, Glasgow University, is

included with a list of the published writings of the author.



20TH CENTURY BOOKKEEPING AND ACCOUNTING. By J. W. Baker. Southwestern Pub. Co., Cincinnati, O. Price, \$1.20.

A treatise on modern bookkeeping, ac-

counting and business customs as illustrated in the "Business Transactions," which accompany the text. A discussion of purchases, sales, inventory, posting, taking a trial balance, etc., taking up each factor in bookkeeping in its logical place. Prepared primarily for the student rather than for the practicing bookkeeper or accountant.

Bank Advertising Exchange

Those listed herewith are willing to exchange booklets, folders and other advertising matter issued by them. Subscribers can get on this list free of charge

Watch for New Names and Other Changes

A

Adams, F. R., Will County National Bank, Joliet, Ill.
 American National Bank, Richmond, Va.
 Ansley, D., c/o Central Trust Co., San Antonio, Tex.
 Art, Carl W., manager publicity department, Union Trust Co., Spokane, Wash.

B

Bader, A. F., publicity manager, Old State National Bank, Evansville, Ind.
 Bailey, C. W., cashier, Southern Trust Co., Clarksville, Tenn.
 Bank of San Rafael, San Rafael, Cal.
 Bankers Magazine, The, New York.
 Bauder, Ray E., cashier, First National Bank, Taylorville, Ill.
 Baugher, E. M., president, The Home Building Association Co., Newark, O.
 Beerbower, C. W., National Exchange Bank, Roanoke, Va.
 Bollman, H. C., assistant cashier, First National Bank, Collinsville, Okla.
 Branham, D. R., 6252 Leland Way, Los Angeles, Cal.
 Brannen, Jesse E., cashier, First National Bank, Westwood, N. J.
 Brooks, T. J., cashier, The Guaranty Trust and Savings Bank, Jacksonville, Fla.
 Brown, R. A., assistant cashier, Citizens National Bank, Raleigh, N. C.
 Bunch, F. E., cashier, Merchants and Farmers Bank, Statesville, N. C.
 Burton, E. C., vice-president, Penn. National Bank, Chester, Pa.

Burwell, Stephen L., vice-president, First National Bank, Jackson, Miss.
 Bush, A., Jr., Ladd & Bush, bankers, Salem, Ore.

C

Citizens Bank and Trust Co., Tampa, Fla.
 Citizens National Bank, Oconto, Wis.
 Copp, R. Reed, assistant advertising manager, National City Bank, New York City.
 Cory, Arthur S., Chehalis National Bank, Chehalis, Wash.
 Craig, David, Tradesmen's National Bank, Philadelphia, Pa.
 Critchell, L. S., publicity manager, Guaranty Trust Co., New York City.
 Crowson, M. Clarence, cashier, Home Banking Co., High Point, N. C.
 Culbreth, Eugene E., Commercial National Bank, Raleigh, N. C.
 Currey, Bradley, c/o Fourth and First National Bank, Nashville, Tenn.

D

Dalby, H. A., Naugatuck Savings Bank, Naugatuck, Conn.
 Davenport, C. M., manager new business department, Bank of Italy, Los Angeles, Cal.
 Dexter Horton National Bank, Seattle, Wash.
 Durham, T. R., assistant cashier, Chattanooga Savings Bank, Chattanooga, Tenn.
 Dysart, W. R., assistant cashier, First National Bank, Ripon, Wis.

E

Eberspacher, J. C., assistant cashier, First National Bank, Shelbyville, Ill.

Keep us in touch with your publicity work. Each month current advertising is reviewed and commented upon, ads are reproduced and criticised in **BANKING PUBLICITY**

Ekirch, A. A., secretary, North Side Savings Bank, New York City.
Ellsworth, F. W., secretary, Guaranty Trust Co., New York City.

F

Finch, E. W., assistant cashier, Birmingham Trust and Savings Co., Birmingham, Ala.
First National Bank, Lead, S. D.
Franklin Society, 38 Park Row, New York City.
Frieden, Ben W., 334 Davidson Building, Sioux City, Iowa.

G

American Savings Bank, Springfield, Mo.
Gooden, B. P., Mercantile Bank of the Americas, New York City.
Groves, J. W., advertising manager, Northwestern National Bank, Minneapolis, Minn.

H

Hamsher, C. F., First National Bank, Los Gatos, Cal.
Hann, Victor F., manager publicity department, The Fifth Avenue Bank, New York City.
Hards, D. L., publicity manager, Wachovia Bank and Trust Co., Winston-Salem, N. C.
Harper, W. A., Lumberman's National Bank, Houston, Tex.
Hatton, E. A., cashier, First National Bank, Del Rio, Tex.
Hill, John R., Barnett National Bank, Jacksonville, Fla.
Hoagland, Jessamine G., publicity manager, National City Bank, Chicago, Ill.
Hokanson, N. M., State Bank of Chicago, Chicago, Ill.

J

Jarvis, Charles D., c/o Savings Bank of Utica, Utica, N. Y.
Jenkins, W. L., Farmers and Mechanics Trust Co., West Chester, Pa.
Jesup, Theodore, Woodlawn Trust and Savings Bank, 1204 E. 63rd Street, Chicago, Ill.
Jones, W. P., assistant cashier, First National Bank of Commerce, Hattiesburg, Miss.

K

Kahn, A. T., vice-president, Commercial National Bank, Shreveport, La.
Kankakee County Trust and Savings Bank, Kankakee, Ill.
Kay, W. H., Jr., advertising manager, Sacramento Bank, Sacramento, Cal.
Keller, C. B., Jr., assistant cashier, Stroudsburg National Bank, Stroudsburg, Pa.
Keyton, Grover, New Farley National Bank, Montgomery, Ala.

L

Lanier, B. W., First National Bank, Lakeland, Fla.
Lindheim, A. E., assistant cashier, Scandinavian-American National Bank, Minneapolis, Minn.
Logan, John, cashier, Columbus State Bank, Columbus, Mont.

M

McDowell, J. H., c/o American Trust and Banking Co., Chattanooga, Tenn.
Mann, Ralph H., Park Trust Co., Worcester, Mass.
Marvel, Charles S., The First-Second Savings and Trust Co., Akron, O.
Matthews, Dave S., assistant cashier, Farmers and Merchants Bank, Stockton, Cal.
Matthews, H. B., S. W. Straus & Co., Straus Building, Chicago, Ill.
Merrill, Frank, advertising manager, The Northwestern National Bank, Minneapolis, Minn.
Meyer, A. J., Union Trust Co., Rochester, N. Y.
Mills, W. C., New Business Department, Metropolitan Trust Co., 60 Wall Street, New York City.
Mulrhead, G. C., vice-president, The Stock Growers State Bank, Worland, Wyo

N

Northwestern Trust Co., R. P. Sherer, vice-president, St. Paul, Minn.
Norton, W. W., treasurer, Robbins Burrall Trust Co., Lakeville, Conn.

O

Old State National Bank, Evansville, Ind.
Overton, J. A., cashier, The National Bank of Smithtown Branch, Smithtown Branch, N. Y.

P

Parish, R. B., cashier, Bluefield Bank, Bluefield, W. Va.
Poole, John, president, Federal National Bank, Washington, D. C.
Potter, A. E., president, Broadway National Bank, Nashville, Tenn.
Potts, W. W., treasurer, The Federal Title and Trust Co., Beaver Falls, Pa.
Publicity Department, St. Louis Union Bank, St. Louis, Mo.

R

Ruff, William J., cashier, Luzerne County National Bank, Wilkes-Barre, Pa.
Russell, W. W., cashier, First National Bank, White River Junction, Vt.

S

Schlenker, Almot, assistant cashier, First National Bank, Brenham, Tex.
Scott, Walker, vice-president, Virginia Trust Co., Richmond, Va.
Shepherd, George W., c/o International Trust Co., Boston, Mass.
Smith, A. C., vice-president, City National Bank, Clinton, Iowa.
Smith, T. K., Jr., manager, Gimbel Brothers, bankers, New York City.
Stephenson, J. E., Atlantic National Bank of Jacksonville, Jacksonville, Fla.
Stewart, F. E., Cheshire Dwellings, Jefferson Avenue, Toledo, O.
Stoner, T. H., cashier, The Peoples National Bank, Waynesboro, Pa.
Stover, J. C., secretary-treasurer, Indiana Savings and Loan Association, South Bend, Ind.

T

Taylor, C. E., Jr., president, Wilmington Savings and Trust Co., Wilmington, N. C.

U

Union Trust Co. of D. C., Washington, D. C.

V

Van Blarcom, Wessels, assistant cashier, Second National Bank, Paterson, N. J.
Van Name, Miss M. I., 515 Stephen Girard Building, Philadelphia, Pa.

W

Wadden, John W., Lake County Bank, Madison, S. D.
Williams, F. H., assistant treasurer, Albany City Savings Institution, Albany, N. Y.
Williams, J. E., assistant cashier, Third National Bank, Scranton, Pa.
Wilson, C. C., c/o Continental and Commercial Trust and Savings Bank, Chicago, Ill.
Withers, K. K., publicity manager, County Savings Bank, Scranton, Pa.

Z

Zimmerman, Frank A., Chambersburg Trust Co., Chambersburg, Pa.
Zimmerman, Paul E., cashier, Oak Park Trust and Savings Bank, Oak Park, Ill.

NEW NAMES

Bennett, H. D., assistant cashier, Capital National Bank, Lansing, Mich.
Kittridge, E. H., advertising manager, Old Colony Trust Co., Boston, Mass.

President Asks State Banks and Trust Companies to Join Federal Reserve System

FOLLOWING is the full text of President Wilson's appeal to non-member state banks and trust companies to join the Federal Reserve system.

"It is manifestly imperative that there should be a complete mobilization of the banking reserves of the United States. All who are familiar with financial operations must appreciate the importance of developing to the maximum our banking power and of providing financial machinery adequate for meeting the very great financial requirements imposed upon our country by reason of the war. A vigorous prosecution and satisfactory termination of the war will depend in no small degree upon the ability of the Government not only to finance itself, but also to aid the governments associated with it in the war, which must be kept supplied with munitions, fuel, food and supplies of all kinds. The banking problem involved is one which concerns all banks alike. Its solution does not depend upon the national banks alone, nor upon the state banks. The burden and the privilege must be shared by every banking institution in the country. The important functions of the Federal Reserve Banks in the sale of the Government's security, in receiving and transferring the billions of dollars involved, in supplying credit facilities, and in protecting the reserves of the country, have become so familiar to all that I am sure it is unnecessary to dwell upon or expound them.

"The extent to which our country can withstand the financial strains for which we must be prepared will depend very largely upon the strength and staying power of the Federal Reserve Banks. The Federal Reserve Act is the only

constructive financial legislation which we have ever had which was broad enough to accommodate at the same time banks operating under powers granted by the general government and banks whose charters are granted by the re-



PRESIDENT WILSON

spective states. The unification of our banking system and the complete mobilization of reserves are among the fundamental principles of the act.

"The state banking institutions for some reason have until recently seemed inclined to hold aloof. Congress a few months ago prescribed very generous terms for the admission of the state banks into the Federal Reserve System, which have removed the objections heretofore raised by state banks when

considering membership. As the law now stands it leaves member state banks and trust companies practically undisturbed in the exercise of all the banking powers conferred upon them by the states. The law provides also in definite terms the conditions upon which any state bank or trust company may withdraw from the system. Many of the largest state banks and trust companies are now becoming members, realizing that to win the war we must conserve all of the physical, financial and moral resources of our country—that our finances must rest on the firmest possible foundation, and that they must be adequately and completely conserved so as to respond instantly to every legitimate demand. How can this necessary condition be brought about and be made permanently effective better than by the concentration of the banking strength of our country in the Federal Reserve System?

“May I not, therefore, urge upon the officers and directors of all non-member state banks and trust companies which have the required amount of capital and surplus to make them eligible for membership, to unite with the Federal Reserve System now and thereby contribute their share to the consolidated

gold reserves of the country? I feel sure that as member banks they will aid to a greater degree than is possible otherwise in promoting the national welfare, and that at the same time, by securing for themselves the advantages offered by the Federal Reserve System, they will best serve their own interest and the interest of their customers. I believe that coöperation on the part of the banks is a patriotic duty at this time, and that membership in the Federal Reserve System is a distinct and significant evidence of patriotism.

“There are probably 8,000 or 9,000 state banks and trust companies eligible for membership which have not yet united with the system. These institutions have it in their power to add enormously to the resources of the Federal Reserve Banks, thereby broadening and strengthening the foundation upon which our whole financial structure must rest. Permit me to urge that every bank officer and bank director owes a solemn obligation to the country which I am sure they wish to discharge. I, therefore, wish again to impress upon them my solemn conviction that they can best measure up to their duties and responsibilities through membership in the Federal Reserve System.”



Smaller Bank Bills

THE Comptroller of the Currency recently made this announcement:

“The President has approved a bill just passed by Congress, which, it is believed, should materially assist in relieving the scarcity of one and two-dollar currency notes which now exists in many sections of the country.

“Since the resumption of specie payments January 1, 1879, no bank notes of smaller denomination than five dollars have been furnished to national

banks for issue, and the issue of five-dollar bills by national banks has been limited to one-third of their total circulation, the other two-thirds being notes of higher denominations.

“Under this new law every national bank will have the right to issue up to \$25,000 of its circulation in one and two-dollar bills, and the limitation which has heretofore prevented national banks from issuing a larger proportion of five-dollar bills is removed.”

Banking and Financial Industry

SPECIAL

The BANKERS
MAGAZINE

SECTION



THE LIBERTY NATIONAL BANK *of* NEW YORK

CAPITAL \$3,000,000.00

SURPLUS 5,000,000.00

UNDIVIDED PROFITS · 1,010,300.00

OFFICERS

HARVEY D. GIBSON	President
DANIEL G. REID	Vice President
CHAS. W. RIECKS	Vice President and Cashier
ALEXANDER M. HALL, 2nd	Vice President
ERNEST STAUFFEN, Jr.	Vice President
JOSEPH A. BOWER	Vice President
FREDERICK P. McGLYNN	Assistant Cashier
THEODORE C. HOVEY	Assistant Cashier
LOUIS W. KNOWLES	Assistant Cashier
FREDERICK W. WALZ	Assistant Cashier
SIDNEY W. NOYES	Assistant Cashier

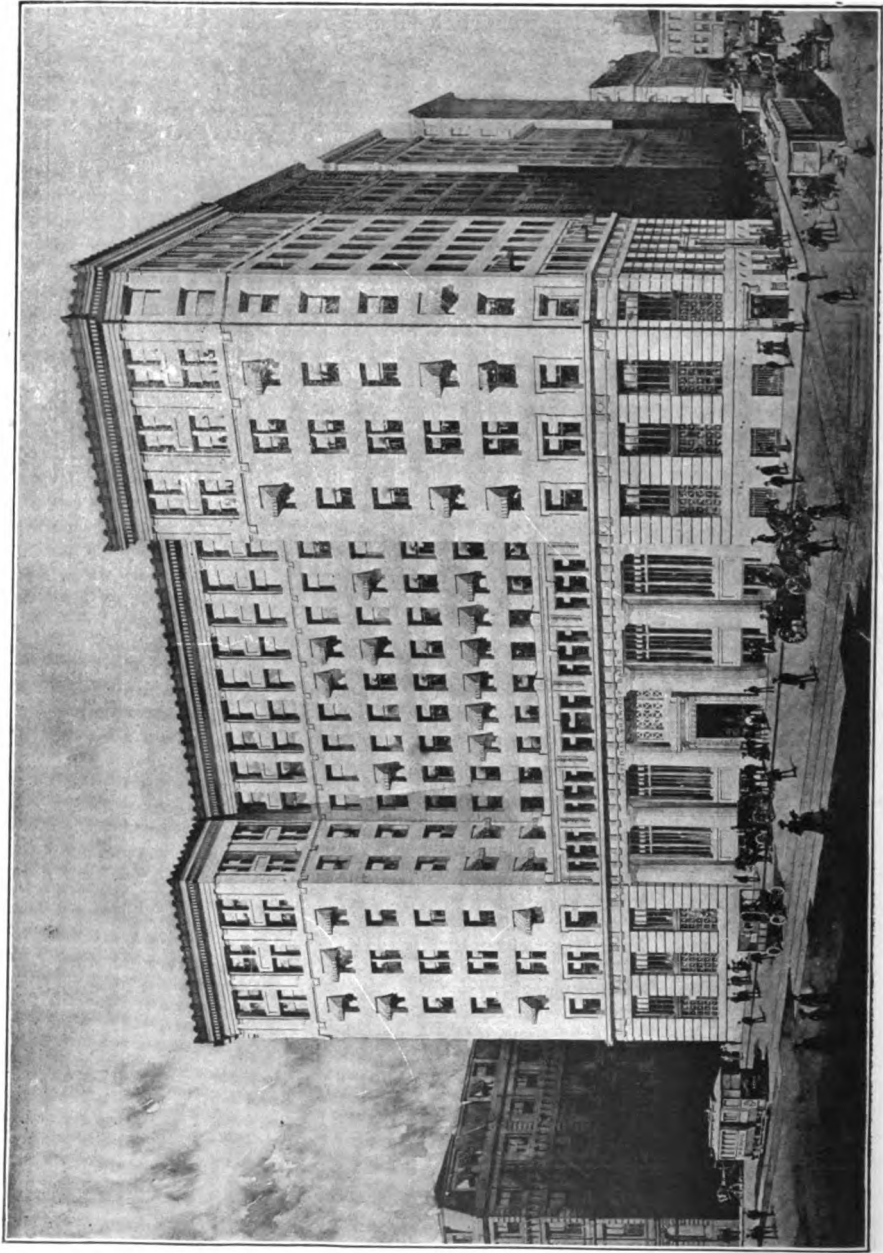

The National Shawmut Bank Building, Boston

The National Shawmut Bank in the Foreign Field



IN connection with the election of Mr. John Bolinger as vice-president of the National Shawmut Bank of Boston, announced in a recent issue, it may be of interest to the

general banking fraternity to know that this is a new step for this old and prominent New England institution.

The National Shawmut Bank has always been conducted on conservative lines and while it has been able to maintain a leading position in New England through the influential relations of its directors and officers, it has not in the past gone systematically after foreign business. In view of the rapid expansion in this department among the banks in the important financial centers, notably New York and Chicago, it is not surprising that the leading Boston banks are preparing to participate more actively in the development of the country's foreign trade.

Only a year ago the complaint was made that the Commonwealth of Massachusetts—although occupying fourth position among the States in the value of manufactured products, and first in the production of boots, shoes and cotton goods—was not progressing industrially at the same rate as some of the other States, and that Massachusetts must awake and bend every effort toward procuring a larger share of the business of the world. Today, however, great progress has been made, as shown by the activity of the Port of Boston, which has been interestingly analyzed in a recent compilation of the National Shawmut Bank.

According to this Foreign Trade Re-

port, the value of all exports through the Port of Boston, for the year ending July 31, 1917, was \$219,638,000 as compared with \$136,830,000 for the previous year, the increase being heaviest in iron and steel products, which increased from \$21,000,000 to \$62,500,000; miscellaneous metals jumped from \$8,000,000 to \$40,000,000; cotton from \$6,000,000 to \$16,000,000.

It is evident that with the many complications and innovations which the European war has imposed upon all international business it is difficult to find competent men who are familiar with these changes and the past and present customs in foreign countries. Mr. Bolinger's experience in international banking has been particularly broad. He is a naturalized American, born in Switzerland, a country that has furnished so many able bankers, especially to Paris and London.

Mr. Bolinger started his banking career with the Banque Cantonale of Neuchatel and the Banque Commerciale of Basle, Switzerland. From there he went to the London branch office of the big French bank, the Societe Generale. After a year he went to New York to enter, in 1905, the employ of the Guaranty Trust Company, then a bank of moderate resources, with a staff in its Foreign Department of but fifteen men. In 1910 he was made assistant manager of this department, which has grown rapidly, and now employs over 300 people.

Having, therefore, practically grown up with the Guaranty Trust Company, which is today the second largest bank in America, there is no doubt that Mr. Bolinger's joining the National Shawmut Bank will broaden its usefulness at this most opportune time, when American manufacturers and exporters

must prepare to meet the tremendous competition that is sure to come from the European countries when the war is over.

Since the war broke out the world's chief money market has been unexpectedly shifted from London to New York. The significance of this, however, and the further fact that this country through the war has emerged as a cred-



JOHN BOLINGER

Vice-President, in charge of Foreign Department,
National Shawmut Bank, Boston

itor nation from its former position of a debtor to the wealthy European countries, are as yet little understood. Many a business man has still to be told that it is now more advantageous for him to use dollar credits instead of sterling credits when importing goods from oversea countries, because dollars for him do not fluctuate as is the case with sterling, because he enjoys a lower discount rate here than in London and also because dollar credits save the commission formerly paid to the English accepting banks.

It may be mentioned in this connection that the capital required for foreign trade purposes and the movement of crops is now from two to three times the amount required when the great war broke out. The financing of a shipment of 100 bales of cotton, for instance, required from \$5,000 to \$6,000 in 1914, compared with over \$17,000 needed today, owing to the increased cost of insurance, freight, etc. This also refers to commodities which we import, such as hides, wool, etc.

While financial experts fully realize that the United States is on the threshold of a tremendous expansion in its commercial credit and loan business thanks to the creation of open discount markets in all the United States cities where the Federal Reserve Bank is established, it is rather remarkable that our usually keen and progressive business men are hardly beginning to appreciate the new situation. The present unelastic American way of making the wholesaler (and his bank) carry his clients by open book accounts was done away with in Europe generations ago by the free use of bank and trade acceptances, which are recognized as the most scientific instrument of commercial finance. They have the additional advantage of providing an ideal bank investment for short and long periods, and of being self-liquidating; they are undoubtedly the foundation of the highly efficient and adaptable banking system established in England, France, and other countries.

The entrance into the foreign field of the National Shawmut Bank will be welcomed. It has been a mercantile bank since its start in 1837; it will, therefore, have no difficulty in obtaining its share in financing imports and exports, and with its large capital and resources should soon become an important factor in the world's commercial financing.

The Shawmut's latest statement shows capital and surplus of \$18,875,000, deposits of over \$136,000,000, and total resources of over \$187,000,000. Its aggregate letters of credit and acceptances then totaled over \$29,000,-

000, as against \$7,200,000 on August 1, a growth that is the best indication of the need of such a department in New England's leading bank.

Preparations are now being made for the establishment of the foreign department in the basement of the big Shawmut Bank building, where it will be completely equipped for carrying on this most important work.

Another feature of great importance in this connection is the fact that the Shawmut has taken an interest in and is represented on the board of directors of the Mercantile Bank of the Americas, which was organized by Brown Brothers & Co., Seligman & Co., the Guaranty

Trust Co. and others. This institution has branches in Paris, Genoa and Barcelona, and is represented by agents in Colombia, Guatemala, Salvador, Honduras and Costa Rica. It is also represented in other countries where local laws do not permit the opening of branch banks, through stock control of the Mercantile Bank of Peru, at Lima; the National Bank of Nicaragua; the Mercantile Overseas Corporation at Guayaquil, Ecuador; the American Mercantile Bank of Brazil, at Para, and the American Mercantile Bank of Venezuela, at Caracas. The Mercantile Overseas Corporation is also about to open a branch at New Orleans.

The Search for a New World

By NICHOLAS MURRAY BUTLER, President of Columbia University, New York

A STUPENDOUS contest is on and the fate of the principles upon which this nation rests, is at stake. We have started, with Italy and France and Great Britain, on a quest like that of Jason of old in his search for the golden fleece. We have started to win a war for a new world. The old world, the world of 1914, the world at home, the world abroad, the world in its domestic conditions, the world in its international relations, that world has gone forever. We have started out in quest of a new world, and this war is at bottom a contest as to whether that new world is to be a place in which men shall live in freedom rather than in fear, in peace rather than in perpetual dread of war; whether it is to be a world of opportunity or a world of despotism; whether it is to be a world in which every individual is called upon to give his best that he may be his best, or a world in which every individual shall take the place that is assigned him by a higher power to do another's will, and subject to no appeal. We are searching for a new world.

This world is near at hand, or else it does not exist at all. Either this new world is where we can go out and find it, and by our resourcefulness and our courage and our skill can create it, or else this new world is in the distant clouds and is a thing of dreams. If, gentlemen, this new world of peace and happiness and prosperity and opportunity and freedom—if this new world of which we are in search—is a dream, then the greater portion of the human race is dreaming. If that is a hopeless vision, then the greater portion of the human race is absorbed in contemplating the unpractical, because, as if sundered by a knife, mankind finds itself in two great camps, professing two opposing faiths, pursuing two opposite ideals, hopelessly in contradiction, not to be compromised, and one to be victorious by force. Never in all history has just such an issue been presented to men before, and that issue presented to Italy, to France, to Great Britain, to America, awaits decision at the hands of our capacity and of our courage.



No. 56 Wall Street, Home of the American Foreign Banking Corporation

American Foreign Banking Corporation

A Strong Organization for the Financing of International Banking and Commercial Business

THIS institution, which opened for business on November 1 at 56 Wall street, New York, represents one of the most important extensions of American banking operations ever undertaken, having for its purpose the entrance into the field of international banking under the combined auspices of a number of the representative banks of the United States. It illustrates the principle of coöperation as applied to banking for this special purpose.

It will be recalled that the same principle has been widely favored in carrying on selling campaigns for American goods in foreign countries.

The question may arise as to why it should be necessary or desirable for the banks to unite in establishing closer connections with foreign countries.

WHY CLOSER CONNECTIONS ARE DESIRABLE

To answer this question involves some examination of the problems involved.

In the first place, from the very nature of the enterprise, the capital required is far above that of the average American bank. If a bank from the United States enters almost any foreign country, it will at once find itself in competition with banks whose capital equipment is very large, and the American bank will lack the confidence it should have in order to succeed if its capital is small. Should the American bank wish to establish branches, it can hardly expect to do so without the qualification of large capital, and the magnitude of the transactions which must be undertaken in the foreign field makes a like demand.

But there are grounds aside from the large capital required which have kept the banks of this country from venturing far from home. The chief of these is the disposition of the banks to do business in localities and under conditions which are known to them, and to be content with the profits which may be had without exploring unknown fields.

THE FIRST SERIOUS MOVEMENT

Until the last year or so the attempts to establish American banks abroad were of the most desultory character. It was not until the passage of the Federal Reserve Act and its subsequent amendment authorizing foreign banking that any really serious movement in this direction was noticeable.

The Federal Reserve Act authorized national banks with \$1,000,000 capital and over to establish branches, with the approval of the Federal Reserve Board. But there was no sudden rush of banks into foreign countries. In fact, although the act did not in any respect grant a monopoly of the new privilege, a single institution practically had the field to itself, solely because it had the capital and the equipment which fitted it for this extended banking prerogative.

But the Federal Reserve Act was amended so as to permit the organization of a bank specifically designed for foreign trade, the stock of which should be owned by other banks.

It was under this provision of law that the American Foreign Banking Corporation was formed. The representative character of the new bank is seen by the fact that among the own-

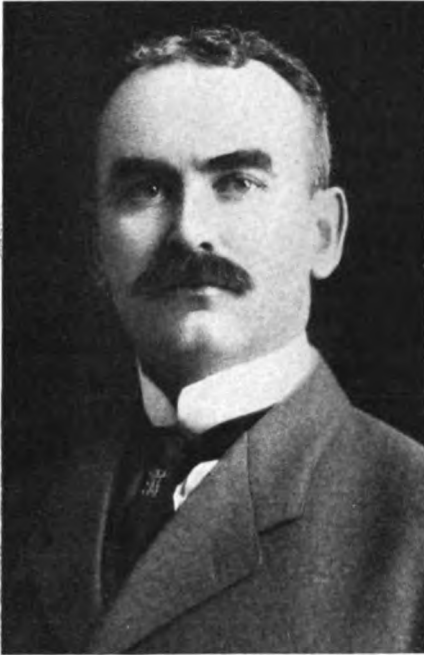

ARCHIBALD KAINS
President American Foreign Banking
Corporation



HAYDEN B. HARRIS
Vice-President American Foreign Banking
Corporation



Officers' Quarters, American Foreign Banking Corporation

ers of its shares are the following leading American banks: Chase National Bank, New York; Merchants National Bank, Boston; First National Bank, Cleveland; Philadelphia National Bank, Philadelphia; Canal Bank and Trust Company, New Orleans; National Bank of Commerce, St. Louis; Corn Exchange National Bank, Chicago; First and Security National Bank, Minneapolis; Fifth-Third National Bank, Cincinnati; Anglo and London-Paris National Bank, San Francisco, and First National Bank, Milwaukee.

Needless to say that a bank having such a list of shareholders to which other banks will be added with the need for greater capital as business develops—will be managed in accordance with the highest standards of banking skill and integrity, and that its operations will be in no sense sectional or in the interest of certain groups of manufacturers and traders, but that it will be broadly representative of American financial, industrial and commercial interests.

To the list of reasons already given as to why the majority of American banks have been reluctant to go into foreign banking may be added another—that this is a department of banking which requires not only large capital but knowledge and experience of a particular kind, with a large staff of officers and employees who are specially fitted to undertake such service. It requires, in fact, both a special type of bank and a special type of banker.

It is believed that all the foregoing essentials of a bank completely equipped and manned for international banking service are combined in the American Foreign Banking Corporation, which now offers its facilities to the banks and to the manufacturing and commercial interests of the country in handling their trade with the outside world. The expectation is that the banks interested as shareholders, and many others, will employ the American Foreign Banking Corporation in handling their foreign business, relying on its special



THOMAS FREDERICK ASPDEN
Vice-President American Foreign Banking
Corporation

facilities to afford a maximum of efficiency.

PRACTICE EVOLVED BY WORLD'S GREAT
NATIONS

The organization of a bank for special forms of service conforms to the practice evolved by the world's great commercial nations. Institutions like the Bank of England, the Bank of France, and the Bank of Japan are the best-known illustrations, now somewhat paralleled by our Federal Reserve Banks. In addition to the great central banking institutions named nearly all the leading commercial countries have special types of banks, such as industrial and mortgage banks and those organized for foreign service.

The fact that America has become the foremost trading nation of the world, and that temporarily if not permanently the world's financial centre has shifted from London to New York calls for the reorganization of our banking sys-



Main Banking Room and Public Lobby, American Foreign Banking Corporation



Another View of Officers' Quarters, and Public Lobby, American Foreign Banking Corporation



Partial View One of the Private Consultation Chambers, American Foreign Banking Corporation

tem to meet the needs of the times. It was especially desirable that there should be an institution like the American Foreign Banking Corporation, embodying in its organization the various factors of success which this institution possesses. This will serve to place the American manufacturer and those engaged in foreign trade more nearly on an equality with their competitors in other lands who have had the advantage of the very highest form of banking service. It will, moreover, save the other banks of the country from the risks they might incur by entering a department of banking which was unfamiliar to them, for which they were poorly fitted, and at the same time will place ready to their hands the most perfect form of special banking service for handling their own foreign dealings.

THE IDEAL IN BANK ORGANIZATION

Indeed, the American Foreign Banking Corporation, in its freedom from the objection of monopoly, in its representative character, and in the high stand-

ing of its sponsors, approaches the ideal in bank organization. It has not been formed in the slightest spirit of antagonism to any institution. On the contrary, it most heartily recognizes the energy and courage shown by the banks already operating along somewhat similar lines, and inasmuch as the development of this phase of American banking is still in the primary stage the belief is expressed by those concerned in the new bank's management that there is abundant room for all—in fact, much greater opportunities for the development of this feature of American banking than are likely to be exhausted for many years to come.

Nor is it intended to compete with local banks, but rather to supply them with better means for transacting their foreign business, believing that they will find this new instrumentality so highly serviceable to them and to their dealers that the use of it in its special line may become an added source of profit to them through its efficiency.

Since THE BANKERS MAGAZINE has

long advocated the formation of a bank of this character, it welcomes the newcomer into the banking field with more than ordinary satisfaction, believing that it is destined to play a most important part in the extension of American commercial, industrial and financial prestige.

THE MANAGEMENT

The fact that the American Foreign Banking Corporation is owned by a number of the leading banks of the country guarantees an exceptionally high standard of management, both with reference to the board of directors and the executive officers. Special care has been exercised in selecting the latter so as to have at the head of the bank and in charge of the various departments men who are thoroughly qualified for their respective duties. It is believed that this object has been attained.

At the head of the institution is Archibald Kains, president; Hayden B. Harris and Thomas Frederick Aspden are vice-presidents, and Charles A. Mackenzie is secretary and treasurer.

Mr. Kains has had a long experience in banking, having served in the Canadian Bank of Commerce for twenty-five years, entering the employ of that Bank in 1882. After service at a number of Canadian points, including London, Toronto and Montreal, he was sent to New York where he spent seven years in the Agency of the Bank there. With the exception of one year spent in Montreal, he has been in this country ever since. He represented his Bank in New Orleans, Chicago, Seattle and San Francisco, and in 1908, when occupying the position of manager in the last mentioned city, accepted the position of special examiner of all clearing house banks of that city, under a con-

tract which he was allowed to break in 1914, in order to enable him to accept the Governorship of the Federal Reserve Bank in the Twelfth District, in which latter position he continued until July of this year.

Mr. Harris was born in Chicago, the son of the late N. W. Harris, banker and philanthropist. He entered the employ of N. W. Harris & Co., bankers, in Chicago, in 1905, and served in various capacities in that firm and later in its affiliated banking houses in Boston and New York until January, 1916, when he retired from Harris, Forbes & Co., New York, to assist in organizing the American Foreign Banking Corporation. He is also a director of the American Russian Chamber of Commerce, Haytian-American Corporation and member of the executive committee of the National Security League.

Mr. Aspden is a native of Manchester, England. He entered the employ of the Merchants Bank at London, Ont., in 1881, where he remained until 1888. From then until 1904 he was with the First National Bank of Chicago, and then engaged in special work for the Canadian Bank of Commerce, traveling in connection with foreign business on the European continent. He was supervisor of the Bank of Commerce, looking after foreign accounts and international relations, until July, 1917, when he was appointed to his present position. Mr. Aspden has devoted a great deal of time to the study and development of business with foreign countries and is considered a specialist in this line.

The American Foreign Banking Corporation was formed with a capital of \$2,500,000 and surplus of \$900,000, which will be increased as circumstances require.



Northern New England's Largest Bank

THE steady growth of Maine's industries, especially those located in and near Portland, created in 1906 an urgent demand for capital—in fact for another bank. Thus the incorporation of the Fidelity Trust Co. was brought about on April 9 of that year. The first officers were: President, Edward P. Ricker; vice-presidents, Charles S. Cook and Frederick Odell Conant; secretary and treasurer, Ernest J. Eddy.

The directors were men of established reputation for successful activity in the business life of the State. Thoroughly informed upon all local conditions, they enabled the bank to furnish



FREDERICK ODELL CONANT
President Fidelity Trust Co., Portland, Maine

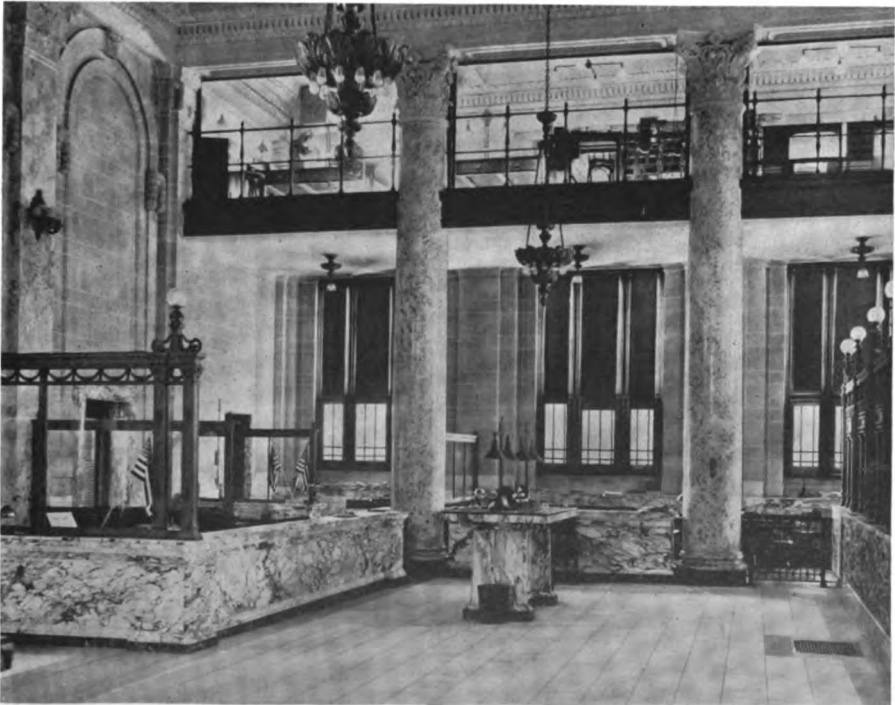

Public Foyer, Fidelity Trust Co.



Here centers the travel and commercial life of Maine—Monument Square and the Fidelity Trust Building



ARTHUR T. SPRING



GEORGE H. WEEKS
Vice-Presidents, Fidelity Trust Co.



THEODORE GOULD

substantial backing for the development of home enterprises—the smaller as well as the more extensive.

INDIVIDUAL SERVICE

In organizing the Fidelity Trust Co. it was the purpose of its founders to offer a source of strong financial support to the large and rapidly growing business interests of the city and State of Maine, thus supplying that aid to legitimate local enterprises which business men of the State had in the past so often found necessary to seek abroad. An important factor in the bank's progress has been a personal interest in the

business affairs of every customer. Regardless of the amount of money involved, it has been the bank's purpose to offer in every case the best service available—best from the standpoint of efficiency and expediency.

HISTORY OF BANK SHOWS RAPID GROWTH

During the past eleven years the sanguine expectations of the bank's founders have been more than realized and at present this institution has the distinction of being the largest general banking house east of Boston.

On August 8, 1908, the company absorbed the National Traders Bank, and



W. S. HAMMONS
Vice-President



CAPT. WILLIAM P. NORTON
Treasurer
Officials of the Fidelity Trust Co.



SILAS F. SKILLIN
Secretary



Directors' Room, Fidelity Trust Co.



Main Banking Room, Fidelity Trust Co.

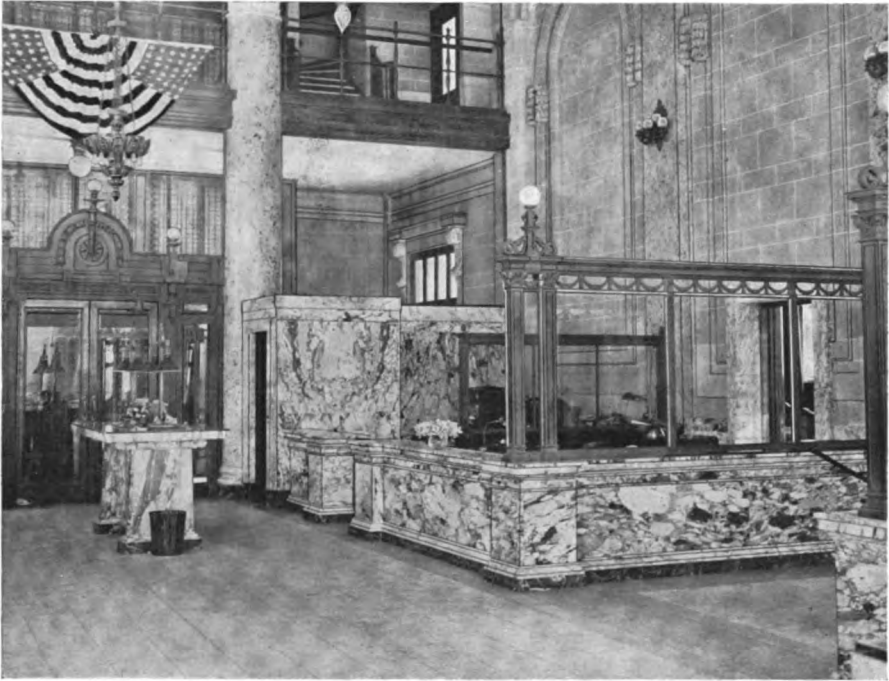

Banking Lobby, Trust and Audit Departments, Fidelity Trust Co.

on April 15, 1910, the Portland Trust Co., which had bought previously the interests of Swan & Barrett, private bankers, and of the Merchants National Bank. With the consolidation of the Portland Trust Co., the bank came into possession of the lease of the Portland Saft Deposit Co. April 22, 1910, the original capital stock and surplus of \$150,000 each were both increased to \$400,000.

The following statement shows the actual growth of the bank since its incorporation:

	NO. OF DEPOSITORS	DEPOSITS	TRUST INVESTMENTS
1906 (About)	1,100	\$633,018	None
1908	2,502	1,251,284	\$1,600
1910	7,416	6,983,318	1,495,225
1912	12,340	8,058,298	2,017,612
1914	15,687	9,003,403	5,949,970
1917	21,297	12,920,596	7,102,817

THE CENTER OF ECONOMIC LIFE

Portland possesses no other location so naturally adapted to facilitate bank-

ing, to best accommodate merchants, citizens, suburbanites and visitors as Monument Square. Here center the travel and commercial life of Maine. The Fidelity Trust Co. has always been identified with this Square and since the annexation of the Portland Trust Co. a branch office has also been continuously maintained on Exchange Street, in the center of the wholesale and commission district. To this branch, which includes a department of safe deposit and storage vaults, merchants and other business men located in that section of the city have convenient access.

In 1910, having outgrown its original banking offices, the company moved across the Square into its present home. This structure is built of concrete and steel and is absolutely fireproof.

The entire main floor, basement and mezzanine balcony are occupied by the company, together with several offices on the second floor. As a matter of in-

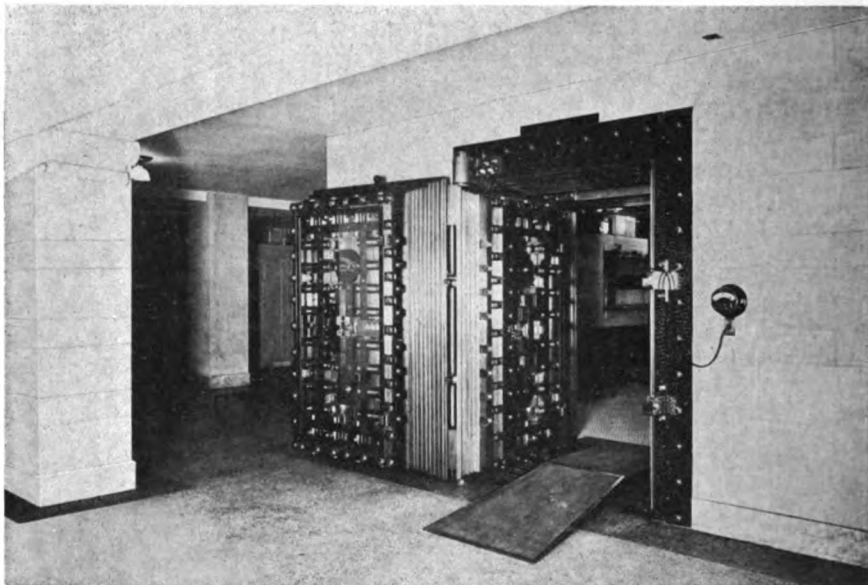

Partial View of 33-ton Doors and Main Vault Entrance, Fidelity Trust Co.



Interior of Safe Deposit Vault, Fidelity Trust Co.

terest the bank uses 15,000 square feet of floor space in this building.

Two entrances lead from the Square to the foyer, a spacious, evenly lighted, well ventilated and pleasant room. The decorations, including the two large writing tables, are of Italian marble. Two pages are always in attendance and are ready to give customers or visitors any desired information.

At the left of the main entrance are the bond, credit, loan and general banking departments, back of which are the president's office and private consultation rooms. At the right are the trust, savings and audit departments. All of these departments are easily accessible to every patron. At the head of each is an official who daily devotes a definite proportion of his time to the bank's patrons. Frequent committee meetings of the officers aid them materially in keeping the various departments running smoothly and without friction, as well as to keep informed of the bank's twenty thousand depositors.

The directors' room is also at the right of the main entrance. This is a large rectangular room paneled in mahogany and comfortably furnished with leather upholstered chairs of the same wood. A massive mahogany table occupies the center of this apartment. A beautiful Tiffany lamp is the only ornament.

Directly in front of the main entrance are the eleven tellers' cages, behind which are the nine bookkeepers who make record of all checking transactions.

WOMEN'S DEPARTMENT

At the right of these windows is the Women's Department. A special effort has been made to meet the requirements of women by placing at their disposal and for their exclusive use a tastefully decorated and well furnished room. Here is to be found everything that may be wished to please the most discriminating. Directly next to this room has been placed a teller to handle the accounts of women patrons. The officers of this bank are ready to offer every courtesy and assistance to all

women in the transaction of their financial affairs.

The mezzanine balcony is occupied by the check-tellers, transit and analysis departments as well as the various department stenographers. Here also are accommodations for the printing and addressograph equipment.

On the second floor the company has several offices which the statement department occupies.

MODERN SAFE DEPOSIT VAULTS

Every modern precaution for the protection of valuables is taken in the safe deposit department, and every facility for the convenience of box holders is provided. This department is located in the basement of the building and may be reached by four elevators. The concrete and armor-plated vault contains over 1,400 individual safes or boxes. Two emergency and double main doors, weighing 32½ tons, protect the vault's contents from fire, earthquake, bombardment and the safe-cracksman. Additional protection is secured by the installation of the appliances of the Bankers' Electric Protective Association. Two armed attendants are on guard here day and night.

Twenty-three booths varying in size to meet the demands of one to a dozen or more persons are equipped with glass tables and writing materials, such as a box renter may need.

In regard to the general equipment of the bank, nothing has been spared in making its present home complete in every detail. The most modern systems and devices are used in every department and a constant effort is made to progress with the times. A conspicuous feature of the office is its conservative appearance throughout, which is consistent with the bank's history of successful achievement.

INVITATION

A cordial invitation is extended to the public and bankers, by the officers, directors and staff of seventy employees of Northern New England's largest general banking institution, who may

wish to know them personally or be shown about the many departments of a modern trust company.

The officers of the company are as follows:

Charles Sumner Cook, chairman of board; Frederick O. Conant, president; Arthur T. Spring, George H. Weeks, Theodore Gould, Walter S. Hammons, vice-presidents; William P. Norton, treasurer; Harry F. Merrill, assistant treasurer; Silas F. Skillin, secretary; James B. Crist, trust officer; Walter P. Deering, auditor.

Directors, Edville G. Abbott, Silas B.

Adams, Charles D. Alexander, Charles I. Bailey, Arthur S. Bosworth, Nathan Clifford, Frederick O. Conant, Charles Sumner Cook, Fred E. Eastman, Bert M. Fernald, Geo. L. Gerrish, Louis B. Goodall, Robert Hale, James C. Hamlen, Charles C. Harmon, Charles M. Hay, Albert H. Hinds, Justin M. Leavitt, Adam P. Leighton, Frank M. Low, Franklin C. Payson, Ernest A. Randall, Edward P. Ricker, J. Henry Rines, David W. Snow, Constant Southworth, Arthur T. Spring, Geo. M. Stanwood, Joseph W. Symonds, Blaine S. Viles, A. H. Walker, Frederick Walker, Geo. H. Weeks, Scott Wilson.

Advantage of the Bank Advice of Credit

By L. W. CRAIG, Assistant Cashier National Stock Yards National Bank, National Stock Yards, Ill.

COMPLYING with your request to give some information regarding our advice of credit to our bank accounts, wish to state that in order to show the true value of this advice it is necessary to mention the name of our institution.

It was not until 1908 that the Stock Yards Bank, which was incorporated under the Illinois laws, was converted into the National Stock Yards National Bank, and had any need of the bank advice, as it was not until this time that we conceived the idea to solicit country bank accounts, on a Stock Yards basis. That is, to have them instruct their customers to have the commission firm deposit the proceeds of the shippers' cattle, on date of sale, with the National Stock Yards National Bank, for use of

the country bank, and advice of the shipper.

From this time on the growth of our bank continued year after year, and we attribute the greater part of our increase to this credit advice, as it places all Stock Yards business on a cash basis, and gives the shipper the security of a bank advice, in preference to a personal check.

Either the check or the advice of credit is apt to be lost in the mails, the difference being that if the check is lost, the shipper has to ask for duplicate; or if the commission firm has given his check to the bank in lieu of their exchange, he will have to stop payment on the bank's draft and give indemnity bond, to safeguard the bank; and while all this is happening, the shipper is out

the use of his money, as well as the country bank. Should the bank advice be lost, the shipper has only to notify his bank, which will either telegraph or telephone us, and we will advise if the shipment in question has been placed with us on date of sale, in which case there need be no bond given, nor duplicate issued, and the country bank has been drawing its interest on proceeds from date of sale.

The advice is a triplicate form written by the commission firm, the amount taken from the shipper's account of sale. We work a color scheme on the advice, that is, a white, a yellow, and a blue slip. The three are deposited with us, we mailing the white slip to the bank, after it is signed by an officer. This notifies the banker that we are crediting his account with a certain amount of money for use of his customer, giving the name of the shipper, and the commission man by whom the amount was deposited. The yellow advice is an office memorandum, which serves as a deposit ticket for our bookkeeper, and the blue slip is stamped, but not negotiable, and given back to the commission firm. This is his receipt for the money.

The shipper is notified of the transaction by the commission firm's writing a memorandum on his account of sales that the proceeds thereof were placed with the National Stock Yards National Bank, for the credit of the home bank, and his use.

The advice which goes to the country bank is not negotiable, but is valid, when officially stamped and signed.

A Spirit of Co-operation

By CHARLES A. HINSCH

WE must instill a patriotic and broad-minded spirit of coöperation in this country between the Government, our bankers, our merchants and manufacturers, our farmers and our laboring classes. If we succeed in this effort we will emerge from this conflict a country with a newborn national spirit, self-reliant and efficient, with a merchant marine flying the Stars and Stripes to carry our products to all parts of the world, and an army and navy calculated to inspire respect for the rights and property of our citizens, wherever they may be.

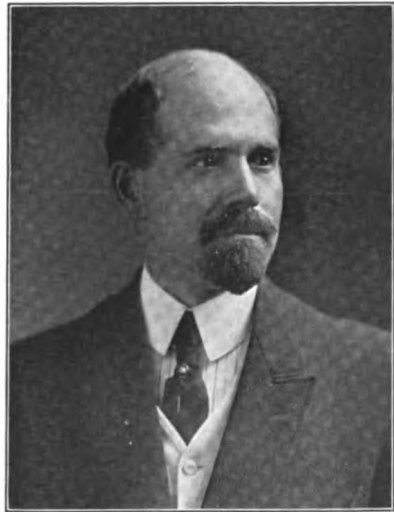

CHARLES A. HINSCH
President American Bankers Association ; President
Fifth-Third National Bank, Cincinnati, Ohio



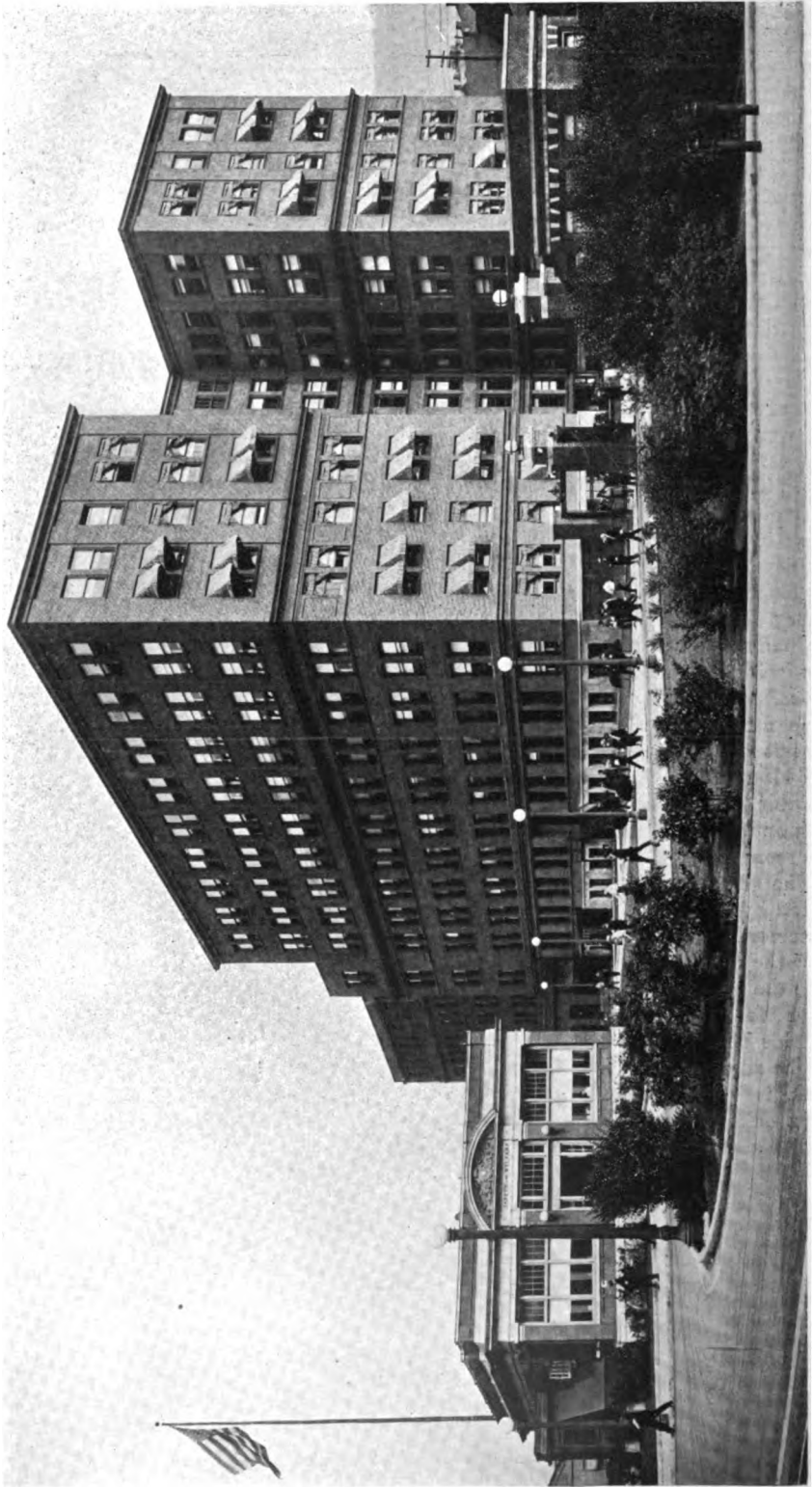

Executive Offices, The Bethlehem Steel Company, Bethlehem, Pa.



CHARLES M. SCHWAB
Chairman of Board, Bethlehem Steel Company



EUGENE G. GRACE
President Bethlehem Steel Company

Bethlehem Steel Company

“The real test of business greatness is in giving opportunity to others.”

—CHARLES M. SCHWAB.

BEHIND this great American industry there looms the figure of one man—Charles M. Schwab. He disclaims being a genius, and in studying the principles and policies upon which the Bethlehem Steel Corporation has been built up, one is disposed to agree with him. There are a few outstanding peaks in Mr. Schwab's business philosophy to which attention may be invited, for they go far to illustrate his extraordinary success.

First—Work hard yourself and se-

lect as your lieutenants those who are distinguished from their fellows by their industry.

Second—Think ahead of the immediate demands of your present job.

Third—Make integrity the unbending rule of your life.

Fourth—Recognize that men who contribute, as laborers or executives, to the upbuilding of a business and to its efficient conduct are deserving of adequate rewards.

These principles are simple and as

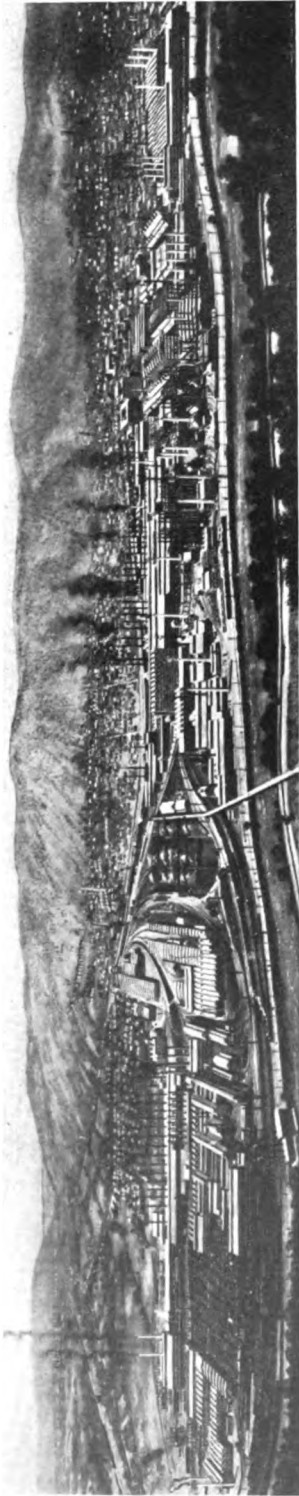

General View of Bethlehem Steel Company's South Bethlehem Works

old as the hills, but they are neglected by the majority of men either in whole or in part.

It is evident that Mr. Schwab understands steel—that he knows his business—but any man, engaged in any kind of business, may acquire a mastery of its details by study and enthusiasm for the work in which he is engaged.

To his own industry and enthusiasm Mr. Schwab has joined the ability to select men of like qualities and those of practical vision, who wisely think of the job ahead as well as the one in hand. Rewarding these men so fully for their industry and ability as to offer the highest incentive to the greatest possible effort, he has found the philosopher's stone as applied to business. As will be seen, while the formula is plain and simple, the results of its application read like magic.

The most interesting thing about this great organization, however, is not the great mills, the wonderful products turned out, nor the immense sums of money earned, but the man who is its dominating figure. The poet who declared that the proper study of mankind is man, had the right idea; and so the best way to study Bethlehem Steel is to study the man who has been the chief instrument in its creation.

What need is there to say that Mr. Schwab's start in life was humble? How many Americans worth their salt started otherwise? That is one reason why he became a successful man. As a boy he learned the lessons of work and of self-reliance. The struggle in early life hardened his muscles, toughened his mental fibre and taught him to depend upon himself.

The principal characteristics of this man, as of all men who amount to anything, are faith and practical vision. To believe in something worth believing in, to see clearly and surely ahead, and then to work without let-up for the realization of the belief and the vision—with these qualities, combined with integrity, the forward march of no man can be stopped.

You may study Mr. Schwab's career

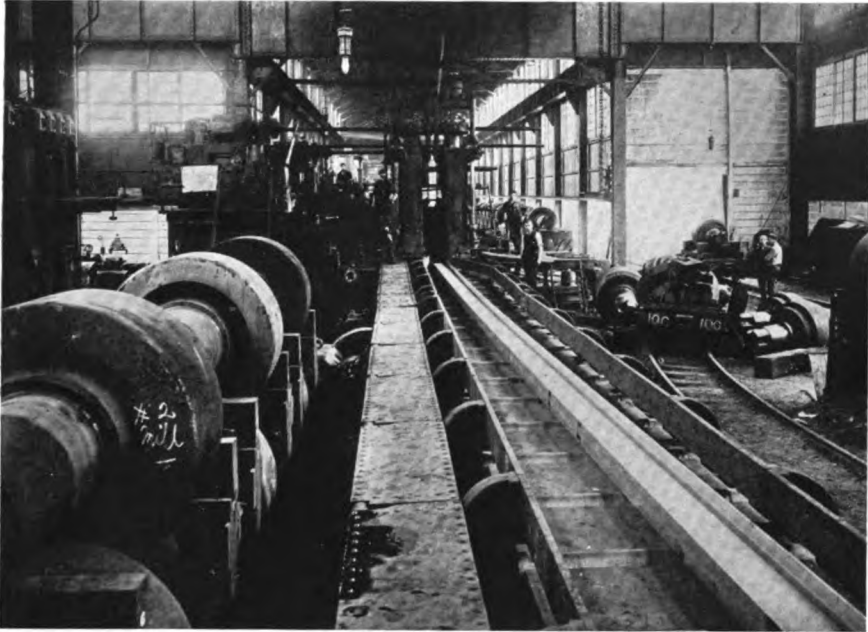

View of Mill where Bethlehem Grey Beams are rolled

as you will without getting much else out of it, and it is a safe guess that he is quite content to let it go at that.

Let us try to get a guage of the man by what he says. His views are thus stated in a little book of which he is the author—"Succeeding with What You Have."

"For thirty-six years I have been moving among workngmen in what is now the biggest branch of American industry, the steel business. In that time it has been my fortune to watch most of the present leaders rise from the ranks, ascend step by step to places of power. These men, I am convinced, are not natural prodigies. They won out by using normal brains to think beyond their manifest daily duty."

* * * * *

"There is not a man in power at our Bethlehem Steel works to-day who did not begin at the bottom and work his way up, round by round, simply by using his head and his hands a little more freely and a little more effectively than the man beside him."

"I have always felt that the surest way to qualify for the job just ahead is to work a little harder than any one else on the job one is holding down."

* * * * *

"The best investment a young man starting out in business can possibly make is to give all his time, all his energies, to work—just plain, hard work."

* * * * *

"The man who has done his best has done everything. The man who has done less than his best has done nothing."

* * * * *

"Nothing is more fatal to success than taking one's job as a matter of course."

* * * * *

"If more persons would get so enthused over their day's work that some one would have to remind them to go out to lunch, there would be more happiness in the world and less indigestion. If you must be a glutton, be a glutton for work."

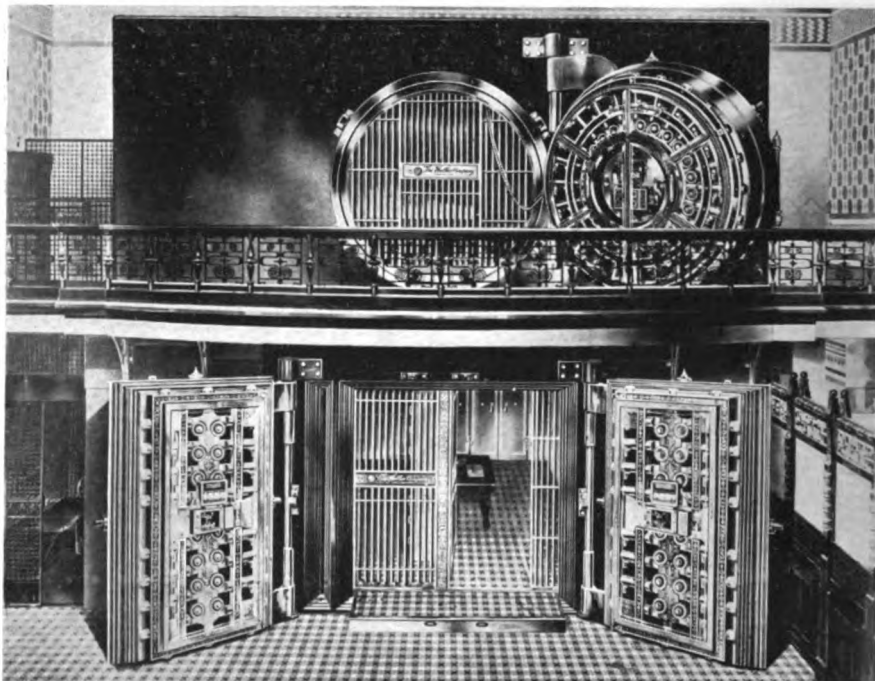

Armor Plate Vault made and installed by Bethlehem Steel Company for the Provident Life and Trust Company, Philadelphia, Pa.

"I have yet to hear an instance where misfortune hit a man because he worked overtime. I know lots of instances where it hit men who did not."

* * * * *

"If a young man entering industry were to ask me for advice, I would say: Don't be afraid of imperiling your health by giving a few extra hours to the company that pays your salary. Don't be reluctant about putting on overalls. Bare hands grip success better than kid gloves. Be thorough in all things, no matter how small or distasteful. The man who counts his hours and kicks about his salary, is a self-elected failure."

* * * * *

"The fellow who sits still and does what he is told will never be told to do big things."

* * * * *

"Integrity is one of the mightiest factors in salesmanship. If you have a reputation for stating facts exactly, for

never attempting to gain momentary advantage through exaggeration, you possess the basis of all successful salesmanship."

* * * * *

"Nothing is so plentiful in America as opportunity. There are more jobs for forceful men than there are forceful men to fill them."

* * * * *

"Real success is won only by hard, honest, persistent toil."

* * * * *

"I love to appeal to the American spirit of conquest in my men, the spirit of doing things better than anyone has ever done them before."

* * * * *

"The Bethlehem profit-sharing system is based on my belief that every man should get exactly what he makes himself worth."

* * * * *

"Many men fail because they do not see the importance of being kind and



View of Armor Plate Vault made and installed by Bethlehem Steel Company for the E. P. Wilbur Trust Company, South Bethlehem, Pa.

courteous to the men under them. Kindness to everybody always pays for itself."

* * * * *

"I believe in people marrying young, for a happy married life is one of the best inspirations a man can have."

* * * * *

"I have always believed that the aristocracy of any country should be the men who have succeeded—the men who have aided in upbuilding their country—the men who have contributed to the efficiency and happiness of their fellow men."

So homely and simple and old-fashioned are these business maxims that you might think them taken from some old dog-eared copybook; but the man who set them down was at 39 the president of the United States Steel Corporation, and is now the head of the Bethlehem Steel Corporation, the holding company for Bethlehem Steel and its subsidiaries. Not long ago he was

offered some sixty million dollars for a half-interest in the latter, and refused the offer.

It has been seen that Mr. Schwab believes in paying a man what he makes himself worth. This is the policy which has brought into the service of Bethlehem Steel men of the greatest ability and skill, because they feel that they will be paid what they are worth. It is the profit-sharing system, whereby men are rewarded for the excellence of their work and the productiveness of their efforts, for economies introduced even in the simplest operations, for the saving in fuel and in the up-keep of machinery and equipment, or in administrative details, and applies alike to all, from the men who run wheelbarrows to President Grace himself.

In President Grace's career we have a striking example of the qualifications that round out and complete the ideal success.

Mr. Grace was born in Goshen, N. J.,



General View of No. 2 Gun Shop, Bethlehem Steel Company

on August 27, 1876, and after graduating from Lehigh University as an electrical engineer, entered the employ of the company in a minor position, but the qualities that make for success brought him one responsibility after the other, and as the increasing demands of a constantly widening field grew and multiplied, the many-sided character and the leadership of Mr. Grace had fuller opportunities to display themselves.

Himself a worker of tireless energy, he has the happy faculty of gathering around him lieutenants who understand him as by intuition, and who are imbued with his own spirit and who follow where his clear vision leads the way.

And to these lieutenants he gives the fullest measure of acknowledgment for all that is accomplished by this wonderful organization, and they share most generously in the material rewards.

These are some of the qualities that compel success. There is one more—the keystone of the arch—as those who best know Mr. Grace describe it, “If

you want to do business with Grace you must enter court with clean hands.”

The substance of the profit-sharing system, referred to above, is that it offers a practical incentive to men to do their best, with the assurance that their efforts will be rewarded. Of course, there is a minimum below which no man's earnings fall, but the best-paid men are those who are ambitious to increase their incomes and who by skill and industry earn a great deal more. Mr. Schwab is proud to think his men are among the most highly paid employes in the steel industry. He feels that the same principles, in modified form to suit special conditions, can be applied to nearly all kinds of business, thus tending to abolish labor troubles, and by the simple expedient of giving to labor its just reward—a policy whose success in this case has been undisputed.

Mr. Schwab has thus expressed himself on this point:

“To make money is a good thing; but it is a far better thing to be able to create opportunities for other men



View of 16-inch Coast Defense Guns in process of manufacture, No. 2 gun shop, Bethlehem Steel Company

to work out their own salvation in life with happiness and contentment.

"Though Bethlehem has prospered, the fact about Bethlehem in which I most keenly rejoice is that, whereas in 1915 we employed 23,000 men, in 1916 some 70,000 men are on our payrolls. In 1915 our total payroll was \$22,500,000; in 1916 it is at the rate of \$72,000,000 a year, or \$6,000,000 a month. The average earnings of each wage-earner in our employ were a little over \$900 per man in 1915, whereas our figures for 1916 show average earnings of nearly \$1,200 per man, an increase of more than 30 per cent.

"The labor problem is far from being solved, but if the managers of industry can develop some universal plan which will make labor not only well paid but happy in doing the work itself, one of the greatest possible boons to mankind will have been realized."

He applied the profit-sharing plan to his own home by offering his steward ten per cent. of the first thousand dollars he was able to save in household expense, twenty-five per cent. of the second thousand, and one-half of the third thousand. The expense of operating the house was cut in two under this plan.

The "little town of Bethlehem," which has now become the centre of warlike industries, had a most pacific origin. It was founded by Moravian colonists on Christmas eve, in the year 1741, and was named in honor of the birthplace of the Prince of Peace.

But Bethlehem, great as has been its fame on account of the manufacture of guns and munitions, has a very big share of the ordinary steel business of the country. Mr. Schwalb, speaking at a banquet tendered him at the Lotus Club in New York by several hundred representative business men, on December 21, 1916, thus voiced this purpose:

"Bethlehem Steel has planned a building and construction program involving an outlay over the next few years of about \$100,000,000. This constitutes, I believe, the largest single construction undertaking ever entered upon by a single industrial corporation. Bethlehem Steel activities up to now have been mainly in the production of ordnance products and munitions. But we are planning for peace. We want Bethlehem to have an efficient ordnance making plant, sufficiently large to serve the needs of our own country, for Europe will no longer need us.

"So when our plan of improvements

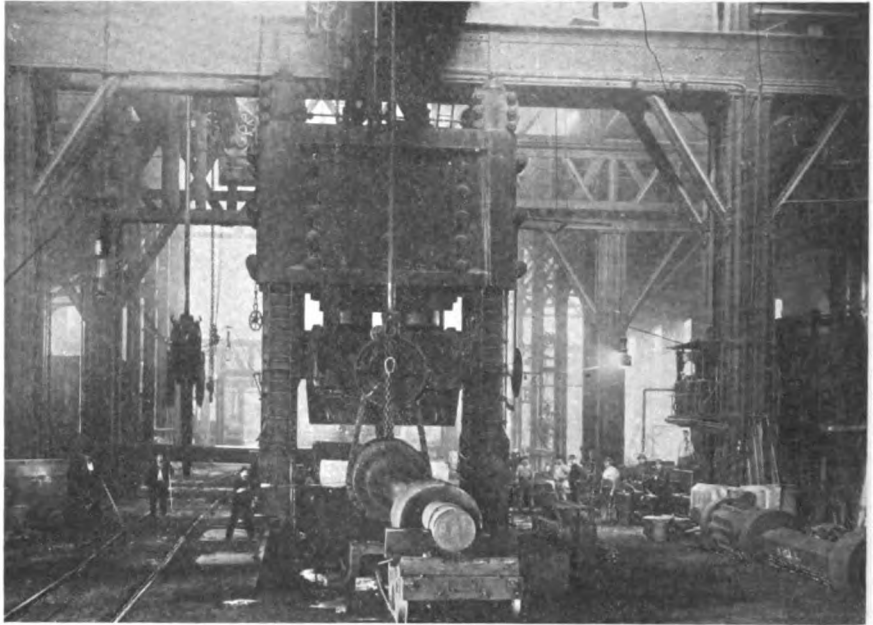

14,000 Ton Armor Plate Press Forge Built by Bethlehem Steel Company

is completed the twenty-five component parts of Bethlehem Steel will consist of only one part ordnance making, four parts shipbuilding, and twenty parts the manufacture of steel for commercial purposes. Bethlehem will have ceased to be primarily an ordnance-making

corporation. Profits of war will have been turned into implements of peace.

"When the war is over there will of necessity be a reduction in the demand for munition steel, and there will be some recession in steel prices generally. But the domestic demands for steel rails,

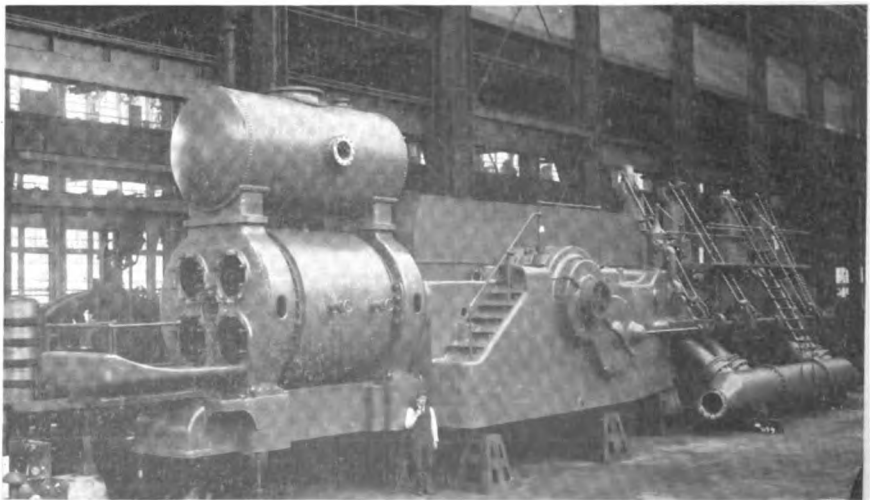

Blowing Engine delivering 25,000 cubic feet of air per minute. Built by Bethlehem Steel Company



View of Traveling Cranes or "Ore Bridges" in Bethlehem Steel Company's storage yard

for building, and for numerous other purposes, await only a more normal condition of trade to press forward for prompt satisfaction. Those domestic demands alone will absorb our steel capacity for many years.

"A period of depression will come some time, and it may be severe, but it will not become acute, in my judgment, until at least three to five years after the war is ended.

"This country cannot stand still. The United States produced only 1,000,000 tons of steel in 1880, while this year 40,000,000 tons have been produced. When the United States Steel Corporation was formed, fifteen years ago, the annual steel production of the country was only 12,000,000 tons and many believed we were then at the zenith of the steel business.

"My own belief is that we are just as far from the zenith today as we were in 1901."

Here again we get a glimpse of the man's large faith in the future. There is a striking illustration of how that faith was vindicated in another instance. Mr. Schwab tells it in the book already mentioned ("Succeeding With What You Have"):

"Once I wrote to Mr. Carnegie about

a rail mill which we had designed at Braddock, and announced enthusiastically that when the mill was completed it would roll over a thousand tons of rails a day.

"I see no objection to the amount of money you want to spend," Mr. Carnegie wrote back, "but I want to exact one promise from you, that you will never tell any one we were foolish enough to suppose that this country would ever require a mill to make one thousand tons of rails a day."

"Now, think of us, after this short time, making from twelve thousand to fifteen thousand tons of steel rails a day!"

The ability wisely to look ahead to the needs of the future is one of Mr. Schwab's characteristics which must always be kept in mind in estimating his career.

Bethlehem Steel is the outgrowth of the old Bethlehem Iron Company, founded in 1861 through the efforts of Joseph Wharton, the financier, and John Fritz, the practical metallurgist. The latter saw the possibilities of the Bessemer process and decided to engage in the manufacture of steel at Bethlehem and this was done in the fall of 1873. The new establishment moved along in a



View of Battle Ship "Rivadavia," built for the Argentine navy by the Fore River Ship Building Corporation, a Subsidiary of the Bethlehem Steel Company

quietly prosperous way, devoting its activities chiefly to commercial iron and steel, but beginning to make armour-plate in 1886. By 1909 the Bethlehem

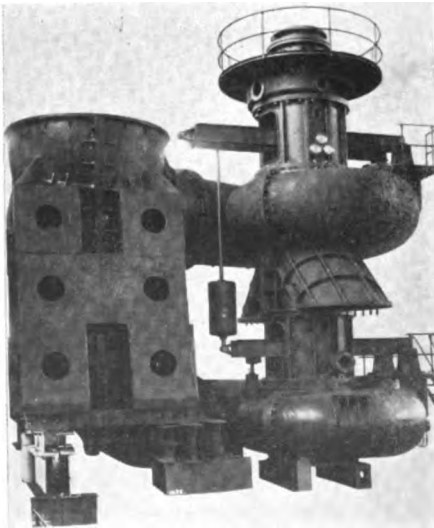

15,000 horse-power Turbine built by Bethlehem Steel Company for the Canadian and Niagara Power Company

Iron Company had a capital of \$7,500,000, and it was in that year that the Bethlehem Steel Company was formed. Prior to this, in 1901, the great United States Steel Corporation had been organized with Mr. Schwab as president. Suggestions for a merger of certain steel properties having been made, Mr. Schwab purchased the Bethlehem Steel Company, but later sold it to J. P. Morgan for what he paid for it. When in 1902 the plans were formed for organizing the United States Shipbuilding Company, Mr. Schwab again bought back the Bethlehem Steel Company, merging it with the new concern, and out of this grew the Bethlehem Steel Corporation, the holding company for the subsidiary organizations, with capital as stated:

Bethlehem Steel Co.	\$15,000,000
Harlan & Hollingsworth	1,000,000
Union Iron Works	2,000,000
Sam'l L. Moore & Sons, Corp.	300,000
Carteret Improvement Co.	300,000
Crescent Shipyard	300,000
Bath Iron Works	500,000
Hyde Windlass Co.	100,000
Eastern Shipbuilding Co.	300,000
Total	\$19,800,000

The Bethlehem Steel Corporation had \$15,000,000 of preferred stock, \$15,000,000 of common and \$3,000,000 of bonds.

Then the important thing happened. Mr. Schwab resigned the presidency of the United States Steel Corporation in 1903 and shortly afterwards became president of the Bethlehem Steel Corporation. From this time the rise in business has been extraordinary. The number of employees increased from less than 10,000 to about 75,000, and from a financial position that was not enviable the earnings on the common shares began paying a handsome dividend and the shares themselves showed a corresponding and marked advance in value. There were, of course, exceptional causes for this marked rise in the value of the stock, the enormous war orders Mr. Schwab had received in Europe being the chief. But other influences were making the shares valuable, particularly the policy of putting back profits into the concern in the shape of expansions and betterments, and it is estimated that by the close of 1919, \$89,000,000 will have gone into new construction. Thus the common stock has an accrued value much enhanced.

Since 1904 the pig-iron capacity has risen from 120,000 tons to 2,300,000 tons, and new equipment already added will increase this to 4,000,000 tons annually.

One of Bethlehem Steel's most important recent acquisitions was the purchase, for \$25,000,000, of the Pennsylvania Steel Company of New Jersey, with its subsidiaries, the Pennsylvania Steel Company of Pennsylvania, the Maryland Steel Company, the Spanish-American Iron Company and the Penn-Mary Coal Company.

This purchase is an asset of great value and influence not alone from the point of a vastly increased output of iron and steel products, but because it represents a notable addition to Bethlehem Steel's already great shipbuilding industry, the ship-building plant at Sparrows Point being one of the most

modern and best-equipped on the Atlantic seaboard.

Because of the Government's increased and urgent need for more ships and yet more ships to meet the present world-wide emergency, Bethlehem Steel consolidated, a few weeks ago, all six of its shipbuilding plants under a new corporation with President Grace at its



Modern Sky-Scraper, showing Bethlehem Grey Beams

head, to be known as the "Bethlehem Shipbuilding Corporation, Ltd." The new corporation takes in, beside the shipbuilding plant at Sparrows Point, Md., the Union Iron Works Company and the Union Iron Works Dry Docks Company, both of San Francisco; the Harlan & Hollingsworth Corporation, Wilmington, Del.; the Fore River Shipbuilding Corporation, Quincy, Mass., and Samuel L. Moore & Sons Corporation, Elizabeth, N. J.

The new corporation was formed because the demands of the Government on the facilities of shipbuilding plants make it essential that all duplications of engineering and similar overhead

work be avoided so far as is possible, and the consolidation of the six plants will, through the resulting standardization and the centralization of management, increase the production of the yards affected—a result of vital importance in this time of insistent demand for expedition in the building of ships.

The tremendous demands for shipping construction alone constitute an earning capacity assuring a splendid revenue, and cheap ore from Chile and cheap water transportation along the Atlantic seaboard are immense advantages, gained again by thinking ahead of the immediate needs of the hour.

It has been pointed out that one of Mr. Schwab's leading characteristics was the wish to see other men succeed.

One of the most conspicuous examples of the men he has brought forward is Mr. Eugene G. Grace, who, as previously referred to, entered the employ of the company in a position of minor responsibility only a few years ago, but who is now President of the Bethlehem Steel Company and of the Bethlehem Steel Corporation.

Charles M. Schwab, the Chairman, has risen at a relatively early age from comparative obscurity to great dignity and power in the business world. Search as you will for the secret of this success, you will find, as was said at the beginning of this story, little more than this: integrity, hard work, practical vision, and the desire to see others succeed. And, of course, Mr. Schwab knows the steel business.

To the Credit Men of America :

Your best powers are to be put to the test during the period of war upon which we have embarked. You are to be called upon for the exercise of your highest skill. Remember that your most effective response will be to maintain poise and steadiness and to refrain from all forms of hysteria.

The Nation needs wise business action just as it needs gallant and noble leadership in the various fighting arms. It is for us to bear this in mind, suppressing first, all tendencies to gamble in commodities, prices and credits both in our own work and in the practices of our customers, and then doing nothing that will unsettle confidence or tend to induce hysteria.

Steadiness and self-containment, no matter what happens, are asked by the Nation of every business man. These are qualities necessary for the defence of the credit system and they will also give us victory in war and a peace that is lasting.

The business men of the country will never fail in patriotism. The right response is certain.

NATIONAL ASSOCIATION OF CREDIT MEN

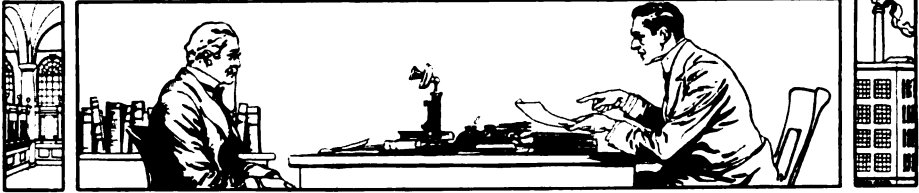

An "Industrial Service" Department For Banks

By GEORGE KINGDON PARSONS

[This is the fifth of a series of articles by Mr. Parsons dealing with the subject of scientific business management and its relation to banking.—The Editor.]

ONE hundred years ago, or even as recently as twenty-five, if any far-sighted individual had been so bold as to predict that the bank of the future would require the services of an expert in the field of industrial management, both as a safeguard against injudicious loans and as a means of promoting the business of its clients, that bold prognosticator would thenceforth have been set down as a crank. The radical character of such a move would have been frowned upon by conservative bank officials.

It is only by going back to early banking history that we realize what a perfectly logical step is being taken by the bank which includes industrial service among its functions. From a profession which was originally elemental in character, banking has grown to be one of the most complex institutions in the commercial fabric. A century ago money was taken in on deposit and loaned out at interest. It was difficult to get a charter in those days, as banks were regarded with a certain degree of distrust, and multiplicity of banking institutions was therefore discouraged. The bank was looked upon merely as a public convenience—the scope of its

usefulness was as yet undreamed of. Occupying this position in the public mind, it is small wonder that the sphere of a bank's activities was in the early days confined almost exclusively to matters of a strictly fiscal nature.

BUSINESS CONDITIONS A CENTURY AGO

This condition can not be attributed to any fault of the bank nor of appreciation on the part of the public of the bank's capacity. The bank's functions remained simple because business was a simple proposition. Let us digress a moment to look at business at the beginning of the nineteenth century.

In these times we can scarcely realize how insignificant by comparison were the industrial and commercial interests of that day. A plant that hired over fifty operatives was the exception. Working capital was small, manufacturers of good repute having frequently to borrow enough at the end of the week to meet their pay rolls. A capital of \$100,000 was a rarity, while \$1,000,000 was beyond the conception of men's minds. Thousands of independent little plants, each turning out a little work in a little way, were scattered throughout the country. The need

had not yet arisen for doing things on an elaborate scale. The era of big consolidations was still far distant. Black smoke had not begun to pour from the thousand chimneys of the United States Steel Corporation. Men had not yet learned to pool their interests in order to manufacture better and more economically. The railroads and steamship lines were just beginning to appear. Agriculture and mining were conducted on a small scale. Everything was callow, formative. The country was industrially and commercially in its infancy, and its organism was simple in proportion.

MEETING THE DEMANDS OF BUSINESS

It must be accepted as an axiom that the requirements of society, whether material or abstract, are realized as soon as they become well defined needs. We have the telephone because the modern business and social structures demand it. The ever-enlarging areas of cities, together with the increasing volume of commerce, have rendered the horse inadequate, and as a result, the motor truck has sprung into existence. Welfare work in industrial plants has been placed in the list of abstract necessities, through the growing knowledge on the part of the plant owners that it is an essential adjunct to factory management.

EXPANSION OF BANKING RESPONSIBILITIES

The banking parallel is obvious. As business expanded, as commerce increased, as agriculture and mining assumed larger proportions, the banking organization of the country as a whole began to assume broader responsibilities. First of all, the need was manifest, and in due season the bank responded to the need. The imposing array of items which banks and bank companies now offer to their clients under the head of service are all the outcome of definite demands which have arisen from time to time. The Foreign Department, the Trust Department and the Bond Department

are only three of many evidences of the bank's ability to serve its clients in diverse ways. No more striking example of the power and facilities of banks for rendering service could be cited than the recent activities of the banking institutions throughout the country in connection with the second Liberty Loan. It is safe to assume that, lacking the impetus imparted by the well-oiled machinery of the banks, plus the powerful publicity which acted as a driving force, this loan would have been a failure.

A NEW FORM OF BANKING SERVICE

Just as the banks have risen to the occasion when the exigencies of the hour demanded prompt and vigorous action in stimulating the Liberty Loan, so they have from time to time responded to the demands made upon them by the business interests of the country at large. The recent announcement made by the National City Bank of New York, one of the largest financial institutions in the country, that it had established a Department of Industrial Service, should not, in the light of existing conditions, cause surprise. This department will be under the management of Vice-president F. C. Schwedtmann, whose experience in industrial management is very extensive. Not every bank will be able to follow the footsteps of the National City Bank so closely as to establish an industrial service department on an elaborate scale, with a trained man at its head, but the type of service offered by that institution can be duplicated just as effectively, on a smaller scale by the employment of outside talent on problems pertaining to industry.

THE WHEREFORE OF AN "INDUSTRIAL SERVICE" DEPARTMENT

But why should the bank concern itself with the management of industry? Does this phase of business come within the legitimate sphere of a bank's activities? Who is benefited thereby?

The bank should identify itself with the industrial management movement for a great many reasons, some of which

I will speak of in detail. As to whether industrial service ought rightfully to be included among the functions of a bank, it should be borne in mind that industrial service is after all only an extension of the bank's credit system. It is investigation carried one step further. If it is legitimate for a bank to make an audit preliminary to the advancing of a loan, it is legitimate for a bank to use such means as may be within its power to further the successful administration of the business. This answers the third question: Industrial service applied directly by a bank or indirectly administered through its agency benefits, first, the bank by making the loan more secure; second, the borrower by promoting his business, and third, the community at large by conserving industrial resources.

The last-named phase is by far the most important, in fact it is by reason of the great good which banks have in their power to confer upon business as a whole through industrial service that they possess the right to enter that field.

REVOLUTIONIZING BUSINESS METHODS

During the past few years business, which for a century had been ambling along at a slow gait, took a sudden spurt. The wheels of industry began to move at an amazing speed. Methods of manufacturing and merchandizing were revolutionized over night. The result was that many concerns, unable to adapt themselves to the sudden change, clung with tenacity to ancient institutions and traditions.

Thousands of businesses of this type have already gone under during the past couple of decades, or are dragging out an existence which must inevitably terminate in business annihilation unless they can reach out and grasp new methods and new ideas.

SURVIVAL OF THE FITTEST

But many of the survivors are in a bad way, in a comparative sense. Recent investigations of the Federal

Trade Commission show a lamentable lack of efficiency on the part of many industrial concerns, particularly with regard to cost keeping. The laxity shown in this department of business is astonishing. There are thousands of manufacturers to-day who do not possess a simple, direct method for determining the cost of goods by units or groups, or for determining wastes and losses. In numerous instances they do not know which are their most profitable lines, and in many cases have been known to sell goods at a loss.

The same condition exists in other departments of business. Office forces are badly organized. Factories are poorly managed. Merchandising is conducted without definite method. These indications of slipshod business management should not be viewed from the angle of pessimism, but rather from the opposite direction, for in spite of their existence, business prospers. All that is needed at the present stage is a little thoughtful deliberation as to the ways and means for remedying existing shortcomings, and after that, discreet controlling influence, which will assure the application of the remedial methods. And what institution is so well qualified to lend itself to this task as the bank?

THE BANK AS A CONTROLLING INFLUENCE

In its community, the bank is looked upon as the bed-rock and foundation of business—it typifies business solidity. And this same aspect of the bank is reflected on a larger scale by the banking institutions of the nation as a whole. We look to the bank more and more every day to serve as the steadying influence in business. The bank is accordingly already in a position to make the one step which will bring it to the point of offering its clients industrial service.

HIGHER EFFICIENCY IN BUSINESS

Business in the future is going to be much more scientifically managed than in the past. There will be less of the hit-or-miss method in evidence—a

greater measure of careful calculation. Industrial concerns will study manufacturing conditions with a magnifying glass, in order to develop efficiency to the highest possible point. They will be more scrupulous in the disposition of their mechanical units, with a view to obtaining the arrangement which will make for maximum production. Materials will be purchased more carefully and used more sparingly. Selling methods will be refined to the ultimate point of effectiveness. Organizations will be coördinated to a degree which will insure coöperative effort without lost motion.

It is to industrial plants of moderate size that banks could most advantageously offer an industrial service. Such a service need not necessarily be a costly one. All banks would not be compelled to follow the precedent established by the National City Bank in maintaining an industrial service department composed of its own officers. Recourse could be had to the services of established industrial engineers who would render service either to the bank or through the bank to the client. The benefit derived from the service would be equally apparent in either case.

There can be no question but that the average manufacturer would appreciate intelligent service of this type, precisely as he appreciates service in connection with banking matters. The bank furnishes the capital with which he runs his business. Why should the bank not keep him posted as to the most advanced practice in business?

INDUSTRIAL MANAGEMENT FROM THE BANK'S STANDPOINT

From the standpoint of the bank itself, a department of industrial service will soon become not only a desirability, but a necessity. The war has created a host of new conditions which will call

for the employment of all our resourcefulness and ingenuity. Sooner or later the war must end, and when it does there is going to be an instantaneous dropping off in the demand along certain lines, followed by a period of readjustment. What will become of this "excess industrial capacity," at which we are now working, when the termination of the war causes a drop in demands? This and other problems of vital moment will presently be put up to the banker. Backed by business engineers he will find it much easier to cope with the situation than if he were to depend solely upon his own judgment.

Never was there a time when accurate credit information was so important as now. The banker must be careful *when* he loans and careful *after* he loans. The financial audit should be thorough and complete, embodying all contingencies which may arise, and eliminating all false valuations. And *after* the audit there should be positive assurance that the business will be scientifically administered. An industrial service department or an arrangement by which the functions of the department could be performed by an established industrial engineer would practically guarantee the success of any enterprise financed by the bank.

But the real value of scientific industrial management, aside from the assurances it may afford to the individual bank and enterprise, lies in its broad economic importance. We are entering into a new era of industrial activity. The old order of things has passed for all time. Industries will henceforth be more astutely managed. Conservation—economy—efficiency—these will be the by-words of future business. By introducing industrial service as one of its functions the bank becomes a powerful contributory agent to the country's future industrial success.



Banking and Financial Notes

STRENGTHENING THE FEDERAL RESERVE

The Federal Reserve System in this country will be tremendously strengthened by the accession as members of big New York institutions, including the Guaranty Trust Co., the Bankers Trust Co., the Central Trust Co., the Equitable Trust Co. and others. The Guaranty will add its resources of over \$600,000,000, while the Bankers Trust Co. has over \$280,000,000 deposits and the Central Trust Co. \$180,000,000, and the Equitable, Metropolitan and others will add millions more. The Broadway, now the Irving Trust Co., was the first New York trust company to join the system.

CHANGES AT BANKERS TRUST CO.

The Bankers Trust Co. has recently organized a complete bond department, with quarters on the third floor of the company's forty-one-story building, and to make room for the increasing demands of the growing business, various changes have been made in the arrangement of the departments. All these departments are connected by telephone, pneumatic tubes and telautographs, the latter also being connected with the uptown office at Fifth avenue and Forty-second street.

BECOMES IRVING TRUST COMPANY

The State Banking Department has authorized the change of name of the Broadway Trust Company of New York to the Irving Trust Company. This follows out the plan approved by the directors and stockholders of the two companies for a joint ownership of stock of the two companies on the ratio of 3 to 1.

MERCANTILE BANK OF THE AMERICAS

The Mercantile Bank of the Americas, Inc., New York, has announced that arrangements had been completed

by which it would hereafter operate under the supervision of the Federal Reserve Board at Washington. This does not mean, however, that the bank has become a member of the Federal Reserve System. The Reserve Board has also authorized investment in the stock of the Mercantile Bank of the Americas by member institutions.

W. M. Van Deusen, formerly cashier of the National Newark Banking Co., of Newark, N. J., has been appointed assistant manager of the Mercantile Bank of the Americas. He was president of the New Jersey Bankers Association a few years ago.



W. M. Van Deusen
Our first President

Merchants National Bank

RICHMOND, VA.

Capital \$400,000
Surplus and Profits over 1,000,000

The Gateway to and Collection
Center for Southeastern States

Send Us Your Items

"ON TO RICHMOND"

Kings County Trust Company

City of New York, Borough of Brooklyn

Capital \$500,000 Surplus \$2,000,000 Undivided Profits \$800,000

OFFICERS

JULIAN P. FAIRCHILD,
WILLIAM HARKNESS,
D. W. McWILLIAMS,
WILLIAM J. WASON, JR.,

JULIAN D. FAIRCHILD, *President*

Vice-Presidents

THOMAS BLAKE, *Secretary*
HOWARD D. JOOST, *Assistant Secretary*
J. NORMAN CARPENTER, *Trust Officer*
GEORGE V. BROWER, *Counsel*

ACCOUNTS INVITED.

INTEREST ALLOWED ON DEPOSITS.

STANDARD BANK OF SOUTH AFRICA

W. H. Macintyre, agent of the Standard Bank of South Africa, Ltd., has just received at the New York Agency, 68 Wall street, a statement of the Standard Bank's position at June 30, 1917, issued October 20th, which reveals remarkable progress when compared with the position a year ago. In the following table are shown some of the principal items in the statement of liabilities and assets of the bank as at June 30 this year and last:

	1916. June 30	1917. June 30
Paid-up capital.....	£1,548,525	£1,548,525
Reserve fund.....	2,000,000	2,000,000
Notes in circulation.	1,269,797	1,759,421
Deposits	26,243,681	29,596,591
Cash in hand at bankers and at call and short notice...	6,316,822	5,578,660
Investments	3,961,042	3,755,717
Bills of exchange...	3,980,730	5,628,253
Bills discounted and advances to cus- tomers	16,539,405	19,579,546

It will be seen that the notes in circulation have increased by £490,000 and deposits by no less than £3,350,000, while £4,680,000 represents the increase in the two items, bills of exchange purchased and bills discounted and advances to customers. The subscribed capital of the bank is £6,194,100, of which there is uncalled £4,645,575.

E. B. CLARE-AVERY GOES WITH CITY BANK

The National City Bank of New York, which has the faculty of attach-

ing to its service some of the brightest young bankers in the country, has added to its staff E. B. Clare-Avery, who will act as St. Louis representative. Mr.



E. B. CLARE-AVERY

Clare-Avery was for several years assistant cashier of the Merchants-Laclede National Bank of St. Louis, and later secretary of the Citizens-Commercial Trust Company of Buffalo, and then



The Chemical National Bank of New York

(Established 1824)

Capital, Surplus and Undivided Profits, \$11,000,000

Co-operation with Banks

Early in its history this institution, through its conservative policies, won the confidence and patronage of other banks.

Unbroken adherence to this conservatism throughout the almost one hundred years of our existence has drawn to us a Banking clientele of the highest order, to whom we offer banking facilities and service of an exceptional character.

Interest paid on balances of Banks, Time Deposits, and Special and Reserve Accounts.

Correspondence solicited

H. K. Twitchell, President
Percy H. Johnston, Vice-President
Francis Haipin, Vice-President
I. B. Hopper, Vice-President
E. H. Smith, Cashier

James L. Parson, Assistant Cashier
J. G. Schmelzel, Assistant Cashier
John B. Dodd, Assistant Cashier
Samuel T. Jones, Assistant Cashier
H. M. Rogers, Mgr. Foreign Dept.

DIRECTORS

Frederic W. Stevens
W. Emlen Roosevelt
Robert Walton Goelet

Charles Cheney
Arthur Iselin
Frederic A. Juilliard

Ridley Watts
Herbert K. Twitchell
Percy H. Johnston

treasurer of the Syracuse Trust Company. His wide acquaintance in the St. Louis territory will make him a valuable assistant to the National City Bank.

FREE EDUCATIONAL COURSES FOR BANK EMPLOYEES

Free educational courses for more than 1,800 employees were reopened on September 24, by the Guaranty Trust Co. of New York. The enrollment is mainly voluntary. The subjects taught are commercial geography, foreign trade, foreign exchange, commercial English, elementary English, French, Portuguese, Spanish and Russian; advanced French, investments and penmanship.

NEW YORK CHAPTER LOSES PRESIDENT

A. F. Maxwell, assistant cashier of the National Bank of Commerce of New York, who was recently installed as president of New York Chapter of the

American Institute of Banking for the year 1917-18, has been compelled to resign that office because of his removal from the city to Dallas, Tex., where he will make his headquarters while acting as southwestern representative for the Commerce. Mr. Maxwell has been actively identified with the chapter since he came to New York in 1913. For the last several years he has conducted its course in credits and has also served on the finance committee and the board of governors.

While his place in the chapter is one which it will be difficult to fill, the members of that organization are proud of this evidence of confidence and appreciation which is thus shown their leader.

No one has been selected to fill Mr. Maxwell's place as president as yet.

APPROVES PLAN OF J. S. ALEXANDER

James S. Alexander, president of the National Bank of Commerce of New York, as noted before in these columns,

THE
**CHATHAM
 AND
 PHENIX**

**NATIONAL
 BANK**
 OF THE
 CITY OF NEW YORK

100 YEARS OF COMMERCIAL BANKING

LOUIS G. KAUFMAN
 President

FRANK J. HEANEY

Vice President

WILLIAM H. STRAWN

Vice-President

NORBORNE P. GATLING

Vice-President

H. A. CLINKUNBROOMER

Vice-President

ROLFE E. BOLLING

Vice-President

WALLACE T. PERKINS

Vice-President

WALTER B. BOICE

Asst. Cashier

VINTON M. NORRIS

Asst. Cashier

RICHARD H. HIGGINS

Vice-President

BERT L. HASKINS

Vice-Pres. and Cashier

C. STANLEY MITCHELL

Vice-President

MAX MARKELL

Vice-President

GEORGE R. BAKER

Vice-President

HENRY L. CADMUS

Asst. Cashier

HENRY C. HOOLEY

Asst. Cashier

JOSEPH BROWN

Asst. Cashier

GEORGE M. HARD
 Chairman

ACCOUNTS INVITED

Resources **Ninety-six Million Dollars**

some time ago suggested that banks encourage the issuance of short term commercial paper for periods not longer than four months instead of six months as is frequently the case. Governor Harding of the Federal Reserve Board in Washington has sent a letter to the twelve reserve banks advising them that the Board has approved this plan. Governor Harding states:

As the Federal Reserve Banks can rediscount only paper which has not more than ninety days to run, it follows that if investments of member banks are in six months' paper, an average of only fifty per cent. of such paper is available at any one time for rediscount; but should the investments be in paper having four months or less to run, at least seventy-five per cent. would on an average have not more than ninety days to run to maturity and would therefore be immediately available for use at the Federal Reserve Bank.

The board is of the opinion that the suggested change would greatly improve the banking condition of the country, as the banks would make a turn-over three times a year instead of twice, and the credits which they would provide would come up for consideration three times instead of twice a year. The borrower in good credit would have no reasonable grounds for complaint and the borrower in doubtful credit would be strengthened by frank conversations with his bankers at more frequent intervals than at present. It is suggested that if the bankers of the country will undertake this change in methods of borrowing and insist upon four months' paper instead

of six, the credit situation will be greatly improved within a short time, responsible borrowers would have greater assurance of credits, and the banks themselves would be in position to meet contingencies with at least fifty per cent. more confidence than under the existing borrowing conditions.

THE FINANCIAL ASPECT OF COTTON

Lewis E. Pierson, chairman of the Board of the Irving National Bank, delivered an important address on this subject before the Southern Commercial Congress in New York October 16. After going into a thorough discussion of his subject in all its bearings, he concludes:

"Whether we consider the financial aspect of cotton, or wheat, or steel, or any other of our great staples, the case is the same, the lesson to the individual and his obligation are clear. Whether he produce, or finance, or govern, his first and most important obligation is to do everything in his power to promote the development of a greater national production and, after that, to use every effort and make every sacrifice to the end that this production may play its greatest part in our greatest national enterprise—to win the war."

BIG DIVIDEND DISBURSEMENTS

Approximately \$5,000,000 in dividends was disbursed by the Bankers

"The Bank That Service Built"

**THE
SEABOARD NATIONAL BANK
OF THE CITY OF NEW YORK**

Capital \$1,000,000
Surplus and Profits (Earned) 3,316,533
Deposits 57,000,000

S. G. BAYNE, President

C. C. THOMPSON, Vice-President

O. M. JEFFERDS, Asst. Cashier

B. L. GILL, Vice-President

C. C. FISHER, Asst. Cashier

W. K. CLEVERLEY, Vice-President

J. D. SMITH, Asst. Cashier

L. N. DeVAUSNEY, Vice-President

B. I. DADSON, Asst. Cashier

H. W. DONOVAN, Cashier

J. E. ORR, Asst. Cashier

DIRECTORS

SAMUEL G. BAYNE

HENRY C. FOLGER

STUART G. NELSON

WILLIAM K. CLEVERLEY

BENNETT L. GILL

JOSEPH SEEP

EDWARD J. CORNISH

EDW. H. R. GREEN

CHARLES C. THOMPSON

MICHAEL J. DEGNON

PETER McDONNELL

WILLIAM H. WOODIN

The success of this bank is founded upon a policy of painstaking, efficient and courteous service to all

ACCOUNTS INVITED

Trust Co. between September 20 and October 20, for account of various companies for which it acts as paying agent. These payments involved the drawing, signing and mailing of about 52,000 checks.

GOES WITH FEDERAL RESERVE BANK

F. I. Kent, vice-president of the Bankers Trust Co. of New York, has been elected an acting deputy governor of the Federal Reserve Bank of New York. Mr. Kent will handle applications for permission to export coin, bullion, and currency at the Federal Reserve Bank but will not give up his work with the Bankers Trust.

NEW CENTRAL TRUST OFFICERS

F. J. Leary, manager of the Forty-second Street branch of the Central Trust Co., and Cornelius R. Berrien, assistant manager, have been elected vice-presidents of the company. Mr. Leary will take up his new duties at the Wall

street office, and Mr. Berrien will assume charge of the uptown branch.

EVERYONE IN BANK SUBSCRIBES

The American Exchange National Bank of New York has the distinction of having everyone of its officers and employees a subscriber to the Second Liberty Loan. The first opportunity to see the new bonds of the second issue was also afforded the public by this bank. The bonds were framed in glass and hung well out over Broadway.

ROYAL BANK ISSUES STATEMENT REGARDING BOLO PASHA'S ACTIVITIES

The Royal Bank of Canada has issued a statement regarding the recent operations of the German spy who now is held in Paris. The bank denies any knowledge of Bolo's activities. The statement made by the bank is as follows:

No transaction of an unusual nature has taken place in the agency of the Royal

National Bank of Commerce in New York

PRESIDENT
JAMES S. ALEXANDER

VICE-PRESIDENTS
R. G. HUTCHINS, Jr.
HERBERT P. HOWELL
J. HOWARD ARDREY
STEVENSON E. WARD
JOHN E. ROVENSKY
GUY EMERSON

CASHIER
FARIS R. RUSSELL



AUDITOR
A. F. JOHNSON

ASSISTANT CASHIERS

A. J. OXENHAM
WILLIAM M. ST. JOHN
LOUIS A. KEIDEL
A. F. MAXWELL
JOHN J. KEENAN
GASTON L. GHEGAN
A. F. BRODERICK
EVERETT E. RISLEY
H. P. BARRAND
R. W. SAUNDERS
H. W. SCHRADER
R. E. STACK

MANAGER FOREIGN DEPARTMENT
FRANZ MEYER

CAPITAL, SURPLUS AND UNDIVIDED PROFITS OVER \$45,000,000

Bank of Canada in New York. Bolo Pasha was introduced to the Royal Bank of Canada by its Paris bankers. A deposit account was opened, but after a short time the funds were withdrawn and transferred to J. P. Morgan & Co. In so far as the Royal Bank of Canada is concerned, the transaction was entirely regular, and the New York office of the bank had not the slightest suspicion that the depositors had any connection with Von Bernstorff or the German Government.

ELECTED CLEARING HOUSE HEAD

At the annual meeting of the Clearing House organization Gates W. McGarragh, president of the Mechanics and Metals National Bank, was elected president, to succeed Frank A. Vanderlip, of the National City Bank, who has served the customary two terms in that office.

Walter E. Frew, president of the Corn Exchange Bank, was made chairman of the Clearing House committee, succeeding Mr. McGarragh. Theodore Hetzler, president of the Fifth Avenue Bank, was elected secretary in place of Joseph Byrne. William J. Gilpin and Clarence E. Bacon were reelected manager and assistant manager, respectively. The Clearing House committee now consists of Walter E. Frew, Seward Prosser, Albert H. Wiggin, Francis L. Hine and Lewis E. Pierson, the last three being new members.

The total transactions of the New

York Clearing House for the year ended September 30, 1917, reached the record-breaking total of \$193,691,822,819, as



GATES W. MCGARRAH
President Mechanics and Metals National Bank,
New York

against \$155,742,333,908, for the preceding year. The average daily clearings for the past year were over \$600,000,000.

Service

The Citizens National Bank of New York for sixty-six years has specialized in accounts of merchants, and is located in the heart of the district where the largest part of New York's mercantile business is transacted.

We are thoroughly equipped to render the best of service to correspondent banks covering their requirements of every nature in New York.

THE CITIZENS NATIONAL BANK OF NEW YORK

Capital, Surplus and Undivided Profits \$5,000,000

EDWIN S. SCHENCK, President

FRANCIS M. BACON, JR., Vice-Pres.

GARRARD COMLY, Vice-Pres.

ALBION K. CHAPMAN, Cashier

JESSE M. SMITH, Asst. Cashier

JAMES McALLISTER, Asst. Cashier

WILLIAM M. HAINES, Asst. Cashier

A. H. WIGGIN FUEL ADMINISTRATOR

Albert H. Wiggin, president of the Chase National Bank of New York, has been appointed by Dr. Garfield fuel administrator for the State of New York.

JOINS FEDERAL RESERVE SYSTEM

W. R. Grace & Co.'s Bank of New York has made application for admission to the Federal Reserve System. J. Louis Schaefer, president of the bank, says:

"Aside from patriotic reasons, there are distinct financial advantages to be derived from joining the system. The paper of the bank will be placed in a better position and immediately strengthened in South America."

The institution is a New York state bank, established in June, 1915, with a capital of \$100,000 and a surplus of \$25,000, to accommodate part of the banking business of the export, import and shipping business of the firm. It

now has a capital and surplus of more than \$1,000,000 and correspondents in all Central and South American countries.

CHANGES IN GUARANTY TRUST

F. J. H. Sutton, trust officer of the Guaranty Trust Co. of New York, since December, 1909, was elected a vice-president of that institution on October 11 last. The trust department of the company was organized in 1902, and Mr. Sutton became a junior assistant in the department at that time. He entered the Guaranty's employ as a messenger in May, 1899, shortly after he was graduated from Princeton. Previous to the election of Mr. Sutton, on October 3, the company announced the following appointments: Ellsworth St. John Prentice, assistant secretary; Samuel Stuart Rapp, assistant secretary; William Ripley Nelson, chief clerk; Thaddeus S. Dayton, manager of the publicity department; T. Y. Butterworth, assistant auditor.

WE ARE *helping our customers*
to meet the UNUSUAL demands
of the present, and are assisting
them in their plans for the future

ATLANTIC NATIONAL BANK

257 Broadway, New York

RESOURCES



\$20,000,000

MERCANTILE TRUST JOINS FEDERAL RESERVE

The Mercantile Trust and Deposit Co. of New York has made application to become a member of the Federal Reserve System. In announcing the action of the board, President Chellis A. Austin said the board was influenced not only by patriotic motives, but also by the desire to equip the institution with every modern and progressive means of handling a growing business.

MAKES ADDRESS REGARDING WAR

Theodore S. Burton, president of the Merchants National Bank of New York, recently addressed the New York Chapter of the American Institute of Banking. In reference to the war Mr. Burton said:

We are at war and this is as much our war as of any nation on earth. All our conjectures and thoughts as to the duration of the contest must be overshadowed by the resolution that the end cannot come

until victory is won. Against us is a nation whose rulers believe that man was made for government, and not government for man, a nation actuated by an insane desire for world domination and in attaining whose objects force, fraud and constant meddling with the affairs of all the rest are the dominant policies. German culture has by no one been more fitly described than by one of their own race as "Learning without character, knowledge without conscience, organization without humanity, discipline without liberty and ideals without dignity." Against this supreme peril we have taken up the sword on behalf of lasting peace, order, liberty and justice tempered with mercy. Our normal activities will indeed in part continue, but in this trying hour our first duty is to our country and to the great causes upon which the world's future depends.

BANK GIVES BONUS TO EMPLOYEES

The National Bank of Commerce in New York announced recently that extra compensation will be paid to its employees in recognition of the prevailing high cost of living and loyal services rendered. The extra compensation

amounts to twenty per cent. of their annual salary for employees receiving less than \$2,000 a year, and sixteen per cent. of their annual salary for employees receiving up to \$4,000 a year.

NEW BANK BUILDING AT PITTSBURG,
KAN.

Hoggson Bros. of New York have begun operations on the construction of a new building, which will be up-to-date in every respect, for the First State Bank, of Pittsburg, Kansas. It will be an individual building of dignified design.

ISSUES BOOKLET ON INCOME AND WAR
TAX LAW

The Chatham and Phenix National Bank has issued a booklet containing fourteen charts, arranged to give the public a quick reference to the important provisions of the income and war tax laws.

MR. ARMSTRONG PROMOTED

Herbert N. Armstrong has been appointed assistant to the president of the American Exchange National Bank of New York. Mr. Armstrong has been connected with the American Exchange since 1893.

VANDERLIP SPEAKS FOR ECONOMY

Frank A. Vanderlip, president of the National City Bank of New York, in a recent speech said:

We must have marketed \$14,000,000,000 in bonds by the end of next June, supposing that we raise \$4,000,000,000 more through taxes. We can place these loans if every bank in the country does its share. I think that some of the contemplated expenditures can be reduced, where estimates are made too far ahead. So far, however, no perspective of our financial situation has been attempted. We need coördinated war policy. There has been some coördination already among the allies, but in general each nation is following its own lines as the United States is. It may be that the war will be shortened if all of our efforts are centered on the Italian front, or on some other point.

We are going to discover that our investing power is greater than we suspected, even to-day. But, at the same time, the lesson of economy must be gotten over. We talk economy, but we do not practice it. We

Resources

\$15,000,000.00

If intelligent handling of items and low rates appeal to you send us your Buffalo business



Try our Service
and you will be entirely
satisfied

- A. D. BISSELL, President
- C. R. HUNTLEY, Vice-Pres.
- E. H. HUTCHINSON, Vice-Pres.
- E. J. NEWELL, Vice-Pres.
- HOWARD BISSELL, Cashier
- C. G. FEIL, Asst. Cashier
- A. J. ALLARD, Asst. Cashier
- G. H. BANGERT, Asst. Cashier

GROWTH --- ONE YEAR

DEPOSITS

September 8, 1917 . . . \$14,804,336.00

September 20, 1916 . . . 7,484,024.00

INCREASE . . . \$7,320,312.00—97%

Citizens Commercial Trust Company
BUFFALO, N. Y.

must prepare for a great expansion of credits which can take place safely on our present gold base. Our problem is serious, and it must engage the best minds, but it can be solved. You may rest assured that it is in good hands.

ELECTED SUPERVISOR OF SALES

R. J. Morgan, who resigned his position with the Midvale Steel and Ordnance Co., has been appointed supervisor of sales of the American Steel Export Co., New York. Mr. Morgan prior to his connections with the Midvale Steel and Ordnance Co., spent thirteen years with the Carnegie Steel Co. and will prove a valuable asset to the corps of thoroughly trained steel men in the employ of the American Steel Export Co.

A PATRIOTIC DUTY

Seward Prosser, president of the Bankers Trust Co., has authorized a

statement in reference to the motives which prompted the trust company to apply for membership in the Federal Reserve System. "While it is true that we considered carefully what the benefits and the possible expenses might be attending membership in the Federal Reserve System," Mr. Prosser said, "in the last analysis we struck aside all minor questions, such as whether it would be profitable or unprofitable, and allowed no technical or political objections to get in the way of the big question. The only reason which really brought about our application for membership was the fact that we had come to the conclusion that we no longer had a right to stay out of the Federal Reserve System when it was our belief that in a large way it was the duty of an institution such as ours to join hands with our government at this time." The capital and surplus of the Bankers Trust Co. is \$22,500,000 and its total assets amount to \$329,000,000.

CHANGES IN GUARANTY SECURITIES CORPORATION

The Guaranty Securities Corporation, Equitable building, New York city, announces the following elections to offices made vacant by resignations and death: Secretary, H. M. Benson; assistant secretary, W. J. Bold; assistant treasurer, D. P. Dinwoodie. At the special meeting of the directors a quarterly dividend of two per cent. was declared and announcement was made of the establishment of a surplus out of undivided profits of \$150,000.

United States Corporation Company

65 CEDAR STREET
NEW YORK CITY

ACTS AS

Transfer Agent and Registrar

FURNISHES

Principal Offices for Corporations in all
States and the Canadian Provinces



EQUIPPED FOR SERVICE

Located in a modern building with every facility for the efficient handling of its business, this bank is in a position to offer you prompt and adequate service in your Philadelphia banking transactions.

**UNION
NATIONAL
BANK**



PHILADELPHIA

Resources over
\$13,000,000

IMPORTANT BRANCH IN GERMAN EAST AFRICA

According to a special cable, just received by W. H. Macintyre, agent of the Standard Bank of South Africa, Ltd., a new branch has been opened at Tabora, an important centre in the territory recently captured by the Allies in German East Africa. This is a further mark of the progressive policy of this bank, which will be glad to answer any inquiries regarding business in that part of the world.

FINE SHOWING FOR BUFFALO BANK

The Citizens Commercial Trust Co. of Buffalo gave its first anniversary dinner October 1, at the Lafayette Hotel to its stockholders, directors, officers and employees. There were over 200 present. The event was held chiefly to celebrate in a certain measure the remarkable progress that has been made during the past year. Deposits have practically doubled, showing a gain for the period of \$7,320,000. It was long

felt that owing to the commercial progress of the city that splendid possibilities existed for a new large bank. Thus, the Citizens Commercial Trust Co. was organized a year ago taking the Citizens Bank on William street, which was founded twenty-seven years ago, and the Black Rock Bank, as a nucleus. The main office was opened in Ellicott square.

Resources now are over \$18,000,000. There are 11,000 accounts in the banking department in addition to which there are 12,000 accounts in the Christmas club operated by them.

W. S. HACKETT BECOMES BANK PRESIDENT

W. S. Hackett was recently elected president of the Albany (N. Y.) City Savings Institution, succeeding the late J. E. Walker. Mr. Hackett had previously been treasurer of the bank for nearly twenty-four years.

BANK URGES CAUTION

A recent issue of "The Advance," the monthly organ of the Corn Exchange



At the Gateway to the Great Southwest

The National Bank of Commerce

IN ST. LOUIS

offers its services for the prompt and dependable handling of your banking business in this section of the country

Capital, Surplus and Profits, over \$13,000,000.00

*“Large enough to serve any—
Strong enough to protect all”*

TOM RANDOLPH, Chairman of the Board
JOHN G. LONSDALE, President
W. B. COWEN, Vice-President
W. L. McDONALD, Vice-President
J. A. LEWIS, Vice-President and Cashier

National Bank of Philadelphia, contains a statement by C. S. Calwell, president, as follows:

Many plants are still operating at capacity, but in some lines, not influenced by government contracts, there is a hesitation that brings to not a few lips the anxious inquiry “how is business?”

The ratio of profits secured the past few years cannot continue indefinitely. It would appear that more moderate profits would be better than holding for any great length of time goods bought at high record prices.

There is no need for worry now, but if your business is not influenced by war purchases we would again suggest very careful study of conditions before contracting too far ahead for goods.

PHILADELPHIA TRUST COMPANY TO JOIN FEDERAL RESERVE

Announcement has been made that the Girard Trust Company will become a member of the Federal Reserve System. The decision was made, it is said, from patriotic motives. This is the first trust company in Philadelphia to make an application.

THE ENORMOUS FARM OUTPUT

According to the quarterly financial review of the Franklin National Bank, Philadelphia, at prevailing prices the value of the grain, fruit, vegetable, live stock and miscellaneous output of the farms this year will exceed thirteen billion dollars, and may reach fifteen billion dollars. Even the lower figure would mean a gain of approximately two billion dollars in the value of farm products over the highest previous record.

CONDITIONS IN PITTSBURGH DISTRICT

The Peoples National Bank of Pittsburgh in its October commercial and financial letter reports local conditions in the industrial line as follows:

Industrial affairs in the Pittsburgh district have been hampered to a certain extent, first by uncertainties connected with the price-fixing policy of the government; second, by the serious shortage in fuel; third, by the continued lack of transportation facilities, and fourth, by the development of some

The
National Shawmut Bank
of Boston
Foreign Banking



Capital . . \$10,000,000
Surplus . . 5,000,000
Undivided Profits 3,900,000

Complete service to banks throughout the country in all branches of Domestic and Foreign business.
Commercial and Travelers' Letters of Credit; Collection of Foreign Drafts.
Foreign Exchange and Cable Transfers purchased and sold.

CORRESPONDENCE INVITED

labor troubles. The effect of price-fixing uncertainties has been to restrain the placing of contracts for new business involving future delivery. Unfilled orders on the books of steel companies are smaller than at any time in several months. This, however, is probably not as serious as appears upon the surface, for the reason that government needs far exceed estimates, and inasmuch as they receive priority in manufacture and delivery, private consumers would be in no better position than they are at present, even if there had been no uncertainty concerning prices. Recently the government announced official prices for coke, iron ore, steel bars, shapes and plates. These prices, which are approximately thirty-three to seventy per cent. below those recently quoted, were the result of agreement between the government and producers after numerous conferences. They became effective at once and will continue until January 1, 1918, when they will be subject to revision if found by trial to have worked inequitably. The new prices apply to the general public as well as to our government and its allies, but they are not expected to prove immediately beneficial to small consumers, for the reason that mill and furnace capacity will be taken up by the war needs at home and abroad and by consumers who had placed contracts for future delivery before the action of the government.

DEPOSITS AT HIGH POINT

The deposits of the Mellon National Bank of Pittsburgh reached \$115,980,875 on September 11, which is the largest line of deposits the institution has reported at any Comptroller's bank call. The deposits about a year ago were \$83,587,142 as of September 12, 1916, and total resources \$96,958,960. This bank prides itself on showing only \$48.92 of overdrafts. This is remark-

able considering that the total resources for the last bank call were \$132,894,720. The surplus and undivided profits \$4,087,116 September 11 this year, compare with \$3,630,858 September 12, 1916. The stockholders receive dividends at the rate of six per cent. per annum on the capital stock of \$6,000,-

The ^{B/L}
Collection Bank
of Chicago



We have a special proposition for any bank or corporation handling bill of lading drafts on Chicago and Eastern points.

UNION TRUST COMPANY
Chicago

Strictly a Commercial Bank
Member of the Federal Reserve System
Established 1869

The National Stock Yards National Bank AND The National Cattle Loan Company

ST. LOUIS NATIONAL STOCK YARDS, ILLS.

Are the largest cattle financing institution in the Eighth Federal Reserve District

WIRT WRIGHT
President

O. J. SULLIVAN
Vice-President

ROBERT D. GARVIN
Cashier

000. Andrew W. Mellon is president; Richard B. Mellon, Alfred C. Knox, Walter S. Mitchell and A. W. McEl-downey are vice-presidents; B. W. Lewis, cashier; H. S. Zimmerman and E. M. Foster, assistant cashiers.

It is stated that the Mellon National Bank, in point of deposits, is the largest bank between New York and Chicago.

NEW BANK WORK

Among the important bank building work from the plans of Thomas M. James, architect, Boston, are the following: A modern colonial building for the Lincoln Trust Co., Wiscasset, Me., for which foundations are now in; a new building for the Cabot Trust Co., Chicopee, Mass.; remodeling of present structure for the Mechanics Savings Bank, Lowell, Mass., and extensive re-

modeling for the Haverhill Trust Co., Haverhill, Mass. Mr. James is also making plans for a modern building for the First-Auburn Trust Co., Auburn, Me., and is to remodel the quarters of the Willimantic (Conn.) Trust Co.

REPORTS AEROPLANE INDUSTRY

The First National Bank of Boston in its recent New England News Letters contains an excellent article concerning the aeroplane industry. The letter says:

Congress has already appropriated about \$640,000,000 for the manufacture of aeroplanes, for the establishment of training stations and schools, and other needs to develop the art of aviation. The government program for 1917 provides for the construction of about 22,500 machines, and according to reliable authority about double the number will be built in 1918.

SEND YOUR BUSINESS

ON THE

Twin Cities AND THE Northwest

TO THE

CAPITAL AND SURPLUS
TEN MILLION DOLLARS

We are prepared to meet your most exacting requirements and cordially invite you to write to us



Is It Not Sound Policy

to send your Baltimore business to the bank whose half century of experience gives assurance of efficiency and strength?

For the handling of collections and all other banking business, this institution is admirably equipped.

Large capital, surplus and resources enable this bank to offer you complete banking facilities and services which are real and not visionary.

The National Exchange Bank Baltimore, Md.

Capital & Surplus, \$2,480,000 Resources, \$12,048,000

WALDO NEWCOMER, President

SUMMERFIELD BALDWIN, Vice-Pres.
JOSEPH W. LEFFLER, Asst. Cash.

CLINTON G. MORGAN, Cashier
WILLIAM R. WEBB, Asst. Cash.

At the time the 1914 census of manufactures was taken there were sixteen establishments with an average of 168 wage-earners, and with a total capital of \$401,000. To-day there is about \$40,000,000 invested in the industry, approximately 15,000 men are employed, and the combined output is about 200 planes a week. The automobile industry can be depended upon, in large measure, for the construction of motors, and the body-making departments may be used for the fabrication of fuselage and wing frames, under the direction of experts. Difficulties regarding patents, which have considerably hampered development, are believed to have been satisfactorily adjusted by the formation of the Manufacturers' Aircraft Association.

NEW BANK BUILDING IN BOSTON

The Warren Institution for Savings of Boston, James O. Otis, president, is about to begin operations on the erection of a new bank building on Park street, opposite Boston Common. It will be a colonial structure of red brick and white marble. The basement, first floor and mezzanine story will be occupied by the bank and the remainder of

the building for offices. Thomas M. James, 185 Devonshire street, Boston, is the architect.

REPORTS BUSINESS DULL IN ARGENTINA

The First National Bank of Boston recently established a branch in Buenos Aires, Argentina. F. A. Goodhue, vice-president of the bank, who has just returned from a visit to this branch, in speaking of conditions in that country, says:

Business in the Argentine is rather dull. There is plenty of money in the country, but the investing class are holding off, waiting for a clearer line on the future. The difficulties which the government is experiencing in its efforts to raise money have possibly created a wrong impression abroad. These difficulties arise not from a lack of money in the country, but from the fact that the people are not accustomed to buying bonds, even of their own government. It has been proposed recently to popularize government securities by issuing a lottery loan of several hundred million pesos.

The condition of Argentine railways is not at the moment satisfactory, but will be

Established
1857



60 Years of Con-
servative Banking

The
**Mechanics-American
National Bank**
of St. Louis

Capital, \$2,000,000

Surplus, \$2,500,000

Resources, \$39,233,000

A STRONG BANK WITH THE EQUIPMENT, THE EXPERIENCE AND
THE STRENGTH TO GIVE THE BEST SERVICE

ACCOUNTS INVITED

WALKER HILL, President

FRANK O. HICKS . . . Vice-President
JACKSON JOHNSON . . . Vice-President
EPHRON CATLIN . . . Vice-President
JOSEPH S. CALFEE Cashier

CHARLES L. ALLEN . . . Asst. Cashier
JAMES R. LEAVRELL . . . Asst. Cashier
C. H. CHASE Asst. Cashier
RICHARD L. KING . . . Asst. Cashier

substantially ameliorated if the roads are successful in their present efforts to secure a twenty per cent. advance in rates. The arbitrary and high-handed methods of labor unions in the South American republic make uninterrupted operation of the roads almost impossible. Entire systems have been tied up on the flimsiest pretext. The Argentine railroads are British-owned, with the exception of the government lines. This is the main reason why Argentina is not a very promising field for American equipment companies.

American packers dominate the beef industry in Argentina and Uruguay. The big Chicago concerns are putting up new plants and generally expanding their operations in that part of the world. Argentine beef is exported chiefly to Europe, but the United States is receiving some.

JOINS FEDERAL RESERVE SYSTEM

The Industrial Trust Co. of Providence, Rhode Island, has made application to become a member of the Federal Reserve System. The bank has deposits aggregating \$63,866,630; surplus and undivided profits, \$1,642,803, and resources totalling \$71,783,303.

COUNTERFEIT \$10 RESERVE NOTE

The office of the Secretary of the Treasury Department has sent out circular letter No. 421 telling of a new counterfeit \$10 note on the Federal Reserve Bank of Chicago (7-G), check letter C, W. G. McAdoo, Secretary of the Treasury, John Burke, Treasurer of the United States; portrait of Jackson. The back of the counterfeit is light blue instead of green. It is a photographic production on two pieces of paper and is poorly executed.

DEATH OF R. V. LANSDALE

R. V. Lansdale, cashier of the National Exchange Bank of Baltimore, who had been connected with the bank since 1882, died on September 22. C. G. Morgan, formerly assistant cashier, has been elected to succeed Mr. Lansdale.

HIBERNIA BANK AND TRUST CO.

President John J. Gannon announces that the Hibernia National Bank of

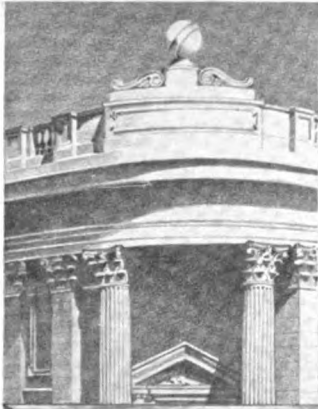

Country Bank Service

Through our Country Bank Department—our membership in the Federal Reserve System and the St. Louis Clearing House Association—we are especially equipped to handle country bank accounts.

Our seven complete departments—Financial, Trust, Bond, Real Estate, Safe Deposit, Savings and Farm Loan—offer every facility.

Our completeness of organization makes for instant and efficient attention to special needs as they arise.

Write for our booklet
"Essentials in the
Granting of
Bank
Credits"

Mississippi Valley Trust Co.
Saint Louis

New Orleans went into voluntary liquidation October 22, 1917. This bank was organized about ten years ago by the same interests which control the Hibernia Bank and Trust Co., mainly for the purpose of taking care of the business of national banks in the interior cities which, under the then existing laws, were restricted in their dealings with state banks and could only keep their reserves with other national banks in reserve cities.

The Hibernia National Bank, therefore, was primarily a bankers' bank, and since all national banks must now keep all of their legal reserve with the Federal Reserve Bank, the necessity for maintaining a national bank to take care of that class of business no longer exists.

Moreover, since the Hibernia Bank and Trust Co. has become a member of the Federal Reserve System it enjoys practically all of the privileges and advantages of a national bank, and is, therefore, in a position to render to banks and individuals exactly the same kind of service which was formerly rendered by the bank.

All of the assets and liabilities of

the bank, therefore, were taken over by the Hibernia Bank and Trust Co. October 22, on which day the Hibernia National Bank ceased to exist.

NORFOLK BANK CHANGES NAME

The Norfolk Bank for Savings and Trust of Norfolk, Va., recently took action to change the name of the bank to the Trust Company of Norfolk and made plans to enlarge the directorate. It was also voted to increase the capital stock from \$100,000 to \$1,000,000. The officers remain unchanged.

REPORTS RAILROAD EQUIPMENT INDUSTRY

The American National Bank of Nashville in its October letter on general trade conditions, speaks with regard to railroad equipment as follows:

Included in railroad equipment ordered during August were only six locomotives for domestic use compared with 115 in July and 41 in August a year ago. Foreign locomotive orders numbered 775 compared with 1,088 a month ago and 144 a year ago. Domestic freight car orders totaled 635 against 5,520 in July and 5,041 in August of last year. Orders for freight cars for export totaled 11,997 in August compared with only 2,300 in July and 10,000 in June. No pas-

Converting Deposits Into Reserve

is the present day test of your ability to turn a losing account into one of profit.

The best collection system is the one that converts out-of-town checks into available cash in the shortest time.

The transit department of this bank receives and despatches mail 24 hours each day.

Send for our booklet

**“The Transfer of Reserves
To Federal Reserve Banks”**

THE

Philadelphia National Bank

(ORGANIZED 1883)

senger cars were ordered in August, and present passenger equipment will have to handle troop movements. Regular passenger service has been materially reduced, but with troops on the move, there will be no surplus of passenger equipment. The impossibility of getting orders filled within a reasonable time is believed to have deterred the placing of new orders for both passenger and freight equipment to a degree.

REPORTS NORTH CAROLINA CONDITIONS

The October number of the “Solicitor,” the magazine of the Wachovia Bank and Trust Co., of Winston-Salem, N. C., speaks as follows regarding local conditions:

The primary necessity is an abundance of food and feed. Farmers everywhere must bend all their available capital and energy to the production of maximum food and feed crops. Every farmer should continue to work at top speed. He should use every energy in order to grow maximum food and feed crops.

This is a golden opportunity for farmers to pay all debts and lay up a few dollars for the rainy day and at the same time fire the shot for liberty that will be heard around the world.

The appeal to the South to live at home and help solve the country's difficulties has already been answered in part. The bumper corn crop, averaging 18.6 bushels to the acre, with fourteen per cent. greater acreage planted than last year, is expected to yield \$1,435,749,780., a gain of 133 1-3 per cent. in actual monetary value over last year.

With a bumper corn crop in sight and with a good cotton crop, worth from \$150 to \$160 a bale, lint and seed, the agricultural South faces an era of prosperity such as we have never before enjoyed.

Conservation all the time, in every phase of his work, is the strongest obligation of the North Carolina farmer to-day.

THE BANKER OF TO-DAY

The Review, the publication of the First National Bank of Chicago, contains an address delivered by Bruce Baird, president of the Chicago Chapter, A. I. B., before the recent convention of the Illinois Bankers Association at Quincy. The address concerns the training of future bankers, regarding the banker of to-day Mr. Baird says:

The banker of to-day is a different type of man. He is energetic, wide-awake, and

a business getter. Instead of waiting for business to come to him he goes after it; he helps the honest man over his troubles, and at the same time keeps an eye on the crook, who tries to impose upon him. There are times each year when practically every line of business needs assistance to tide it over its dull season, and the present day banker is ever ready to help, and instead of demanding a large amount of collateral he gives credit according to the borrower's honesty, integrity, conservatism, and business ability. The bankers of to-day, then, must have a broader conception of business, and business conditions than his predecessor. He must understand local conditions and national conditions; he must know what effect a good grain crop in Minnesota will have on the price of his customers' grain crop, or how a cattle disease in Texas will affect the price of cattle in his community; he should be able to advise where the best markets are, and how best to reach them in the quickest and cheapest way.

COMMENTS ON LABOR SITUATION

The National City Bank of Chicago in its October financial and business letter comments on the labor situation in the country as follows:

Withdrawal of about one million men for military training has reduced the supply of workers. Efforts of certain employers to entice the best trained workers from rival plants has caused much trouble on the Pacific Coast and elsewhere. One shipbuilding concern in order to maintain a capacity working force offered a thirty-three per cent. increase in wages to the best men in other plants. This had the desired effect, but it disturbed conditions to such an extent as to force the government officials to urge employers not to resort to such tactics in the future. The decision of the United States Steel Corporation to raise the wages of about 270,000 employees ten per cent. reflects the constantly increasing wage scale in the steel industry. Average wages for most of the great industries are to-day at the highest known level. The serious shortage of workers in many industries is causing conditions which make for inefficiency, since the laboring man has so many jobs offered him that he does not have to put forth as much effort as usual to keep steadily employed. This shortage is not likely to be relieved as long as war lasts and it is not easy to see how the problem can be solved until the urgent work of restoring the world to a peace basis is taken up. The solution will probably be a progressive one and partly dependent upon the willingness of the great nations to permit emigration to the United States on a large scale after the war is over.

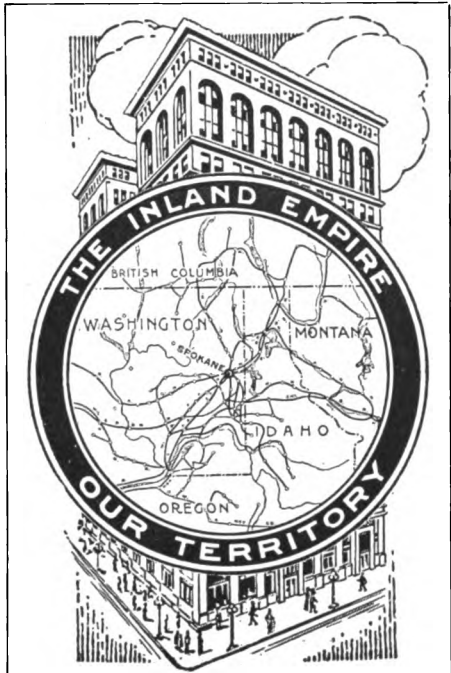

The Old National Bank of Spokane

WITH direct connections in every banking point throughout the "Inland Empire"—a region three times the size of Alabama, of which Spokane is the financial and railroad center—The Old National has the facilities to collect your Pacific Northwest items with exceptional economy and dispatch.

OFFICERS

D. W. TWOHY, President
T. J. HUMBERD, Vice-President
W. D. VINCENT, Vice-President
J. A. YEOMANS, Cashier
W. J. SMITHSON
G. H. GREENWOOD J. W. BRADLEY
Assistant Cashiers

RESOURCES : \$20,000,000



INDUSTRIAL TRUST COMPANY

PROVIDENCE, R. I.

Assets over . . . \$70,000,000

SAMUEL P. COLT, Chairman of the Board of Directors

	H. MARTIN BROWN, President	
JOSHUA M. ADDEMAN	Vice-President	HENRY B. CONGDON Secretary
JAMES M. SCOTT	Vice-President	J. CUNLIFFE BULLOCK Trust Officer
FRANK C. NICHOLS	Vice-President	ELMER F. SEABURY Assistant Treasurer
SAMUEL M. NICHOLSON	Vice-President	HARRY C. OWEN Assistant Secretary
WARD E. SMITH	Treasurer	HENRY C. JACKSON Assistant Secretary

BANK REPORTS GENERAL CONDITIONS

The October financial and business letter of the First National Bank of Chicago, in speaking of general conditions, says:

There is no reason to doubt that the serious economic problems presented by our

entrance into the war will be solved with as little real injury to business as in the case of any of numerous national economic issues of the past. Although we have been at war for six months, a brief survey of the various measures of business activity fails to reveal any cause for alarm. Bank clearings continue to run substantially ahead of last year, although most of the increase may be accounted for by the higher level of prices. New building has subsided on rising costs, and not because of any over-construction. The continued heavy output of corporate charters seems to imply that opportunities for profitable enterprise are more numerous than ever. Commodity prices have reached a halting stage, but supplies in most cases are too small to cause anticipation of any precipitate decline in values, if at all. The failure situation continues reassuring, the outstanding feature being the very small number of large insolvencies. The labor scarcity, finally, may be regarded as chronic, but at least it denotes no unemployment for a long time to come.

To Increase Deposits

The Bankers Service Corporation offers a service for the increasing of deposits.

Results guaranteed by an organization fitted by experience to get all the deposits in your community which are "gettable."

Present abnormal conditions require a maximum of EFFICIENCY in advertising—We have it.

**Bankers
Service Corporation**

258 Broadway, New York City

THIRD NATIONAL OF ST. LOUIS PAYS BONUS IN LIBERTY BONDS

F. O. Watts, president of the Third National Bank of St. Louis, announced action of the board of directors, giving a bonus to every employee, inclusive of officers. This bonus amounting to ten per cent. of the annual salary paid each employee, will be paid in new Liberty Loan four per cent. bonds, aggregating \$25,000. An unusually profitable year, partly due to great business activity and also attributable to the faithful and loyal efforts of the bank's organization, prompted this liberal profit-sharing recommendation by the bank.

Mr. Watts stated that before the rec-

ommendation of the board was given out practically all of the Third National employees had already subscribed to the bonds, but it was decided nevertheless to pay this bonus in additional Liberty Bonds which the bank has purchased for this purpose, because the directors wish to encourage employees in making investments of the very highest class, and for the further reason that it is the patriotic and imperative duty of every employee to purchase these bonds even to the extent of self-denial and sacrifice.

In his announcement to the employees Mr. Watts said: "I look to the officers, directors and employees of the Third National Bank to set the example of patriotism, self-denial and unselfish service in this national crisis. Furthermore, I consider it incumbent upon every firm and corporation in this country to purchase these bonds to the full limit of their ability."

ISSUES BOOKLET ON FEDERAL RESERVE SYSTEM

The Mississippi Valley Trust Co. of St. Louis has issued in booklet form the excellent address given by Breckenridge Jones, president, before the trust company section of the convention of the American Bankers Association held recently at Atlantic City. The booklet gives in a concise manner all the inducements which the system offers to a trust company and is one of the few booklets of its kind.

Do you know how Georgia inheritance laws provide for your mother?



If you are unmarried, and die without legal dependents, and without making a will, your mother will inherit nothing from your estate if your father is living. If your father is dead your mother will inherit only the same amount a brother or sister receives—even a half-brother or half-sister on your father's side.

Are they entitled to inherit from you as much as your mother, to whom you owe so much of your success?

Should you not protect her against every contingency by having your lawyer carefully draw a will, providing for her interests?

The Atlanta Trust Company, as executor or trustee, will see that the provisions of your will are faithfully carried out, and will relieve her of all worry in connection with managing the estate.

ATLANTA TRUST COMPANY
140 Peachtree Street

An advertisement
prepared by
EDWIN BIRD WILSON, Inc.
Financial Advertising
Bankers Trust Building
NEW YORK

OFFICERS ILLINOIS BANKERS ASSOCIATION

At the twenty-seventh annual convention of the Illinois Bankers Association held at Quincy recently the following

DJÖRUP & McARDLE

Bank, Commercial, and Foreign
Exchange Audits and Systems

42 BROADWAY **NEW YORK**

HYDRO-CRETE

TRADE MARK

A NEW CONCRETE FOR BANK VAULTS

PRACTICALLY

FIRE, WATER AND BURGLAR PROOF

VAULTS INSTALLED AND UNDER CONTRACT

Federal Reserve Bank	- - - -	New York City
Guaranty Trust Company	- - - -	"
Metropolitan Life Insurance Company	- - - -	"
Sixty Liberty Street Corporation	- - - -	"
Rhode Island Hospital Trust Company		Providence, R. I.

BY THE

HYDROLITHIC WATERPROOFING CO., Inc.

1328 Broadway

NEW YORK CITY



ESTABLISHED 1865

PEIRCE SCHOOL

OF BUSINESS ADMINISTRATION

Pine Street, West of Broad

PHILADELPHIA

A Business Course, including banking, accounting, business management, commercial law and other practical subjects, which forms an admirable substitute for a college education and saves from two to three years of time.

Special Courses in banking and business administration for students who have had one or more years in college.

Secretarial Courses for those desiring to prepare themselves for secretarial work.

The school is known throughout the United States for the excellence and thoroughness of its business training. Its graduating classes have been addressed by ex-Presidents Taft, Roosevelt, Harrison and Cleveland.

One of the best school buildings in the country; large gymnasium.

Students may enter at any time during the school year.

Fifty-second Catalogue and Illustrated Booklet will be mailed upon application.

officers were elected: President, Robert R. Ward; vice-president Benton State Bank; vice-president, Charles R. Ireland, cashier Washburn Bank; chairman executive council, Nelson N. Lam-pert, vice-president Fort Dearborn National Bank of Chicago; treasurer, Maurice A. Mudd, cashier First State Bank of Chester; secretary, M. A. Graettinger.

CONDITIONS IN CLEVELAND DISTRICT

W. E. Ward, vice-president of the Union National Bank of Cleveland, regarding local conditions recently stated:

Business conditions in Cleveland and vicinity are active at this time. A great deal of work is being carried forward in war orders. Labor is well employed at high wages. Retail business is reported in satisfactory volume, somewhat ahead of last year. The demand for money at banks has been strong

Thanksgiving Day And World Liberty

From love of liberty sprang our first Thanksgiving—and from a mighty courage.

America today, with that same courage backed by stupendous wealth of national resources, champions world liberty, safeguards its own.

In this great work each has a part, and especially the Banker. The sustaining of confidence, and the vital subject of War finance: both are within his province.

Cooperating with Bankers the country over is the Collins Staff of financial publicity specialists.

COLLINS PUBLICITY SERVICE
Philadelphia, Penna.

Increase Your Deposits!



Distribute
**BULLET
BANKS**

Among Your
Depositors

Create New Ac-
counts Thru the
Use of this Safe.

**FREE
SAMPLE**

on request
to Officials of Bank-
ing Institutions.

Write us for particu-
lars.

Be First in Your
City to Use This
Bank.

**Stronghart
Company**

1510 S. Wabash Ave.
Chicago

during the recent weeks, based upon the large inventories required to be carried for the prosecution of work in hand and contracts assumed by our manufacturing interests.

ISSUES PAMPHLET ON BANK FORMS

The Cleveland Trust Co. of Cleve-land, Ohio, has issued volume three in the library of banking. This volume gives the various forms used in banking with a concise explanation of the reasons for and uses of the forms most commonly used in good banking. It is attractively printed and well illustrated.

OHIO BANKS PROSPEROUS

A reflection of the prosperous condi-tion of Ohio as well as the United States is seen in the comparative state-ment of the conditions of state and pri-vate banks, as reported to the superin-



BANKING ROOM
 NORWOOD TRUST COMPANY
 NORWOOD, MASS.

THOMAS M. JAMES
 ARCHITECT
 185 DEVONSHIRE STREET.
 BOSTON, MASS.

tendent of banks at the close of business September 11, 1917. In keeping with the policy of this department, the following comparative figures are compiled from some of the most important items: The total resources were \$959,977,815, an increase since June 20, 1917, of \$27,852,564, and an increase since September 30, 1916, of \$124,701,553. Total deposits on September

11, 1917, amounted to \$843,495,259, the greatest ever shown, exceeding by \$28,187,318 the deposits of June 20, 1917, and exceeding by \$110,044,279 the deposits of September 30, 1916. There has been a gain of deposits during the past three months of \$9,400,000 a month. There are 598 state and 178 private banks as compared with 594 state and 180 private banks June 20, 1917, and 573 state and 185 private banks September 30, 1916.

Accurate News of Pacific Northwest

Have You Business or Investment Interests in Washington, Oregon, Montana, Idaho, Alaska or British Columbia?

The authoritative commercial and financial publication of this section is **BUSINESS CHRONICLE OF THE PACIFIC NORTHWEST** issued every Saturday Morning. It tells what you need to know of banking, investments, lumber, fish, apples, agricultural products, mining, foreign trade, railway and marine transportation, commercial and business affairs generally, and analyzes current progress and development. You may rely upon what you see in its columns.

Send for free sample copy. There is no paper like it anywhere.

BUSINESS CHRONICLE

EDWIN SELVIN, Editor
 Alaska Building SEATTLE, U. S. A.

IN THE DETROIT DISTRICT

The "Detroit Review," the monthly publication of the Detroit Real Estate Board, in commenting on local conditions, says:

Bankers express the opinion that Detroit is now entering the greatest period of industrial activity in its history and that the result will be an increase in general prosperity. In the past thirty days several industrial enterprises have been launched with individual capital in excess of \$1,000,000. Many new plants are in course of construction and new orders for products aggregate \$250,000,000. It is important that notwith-

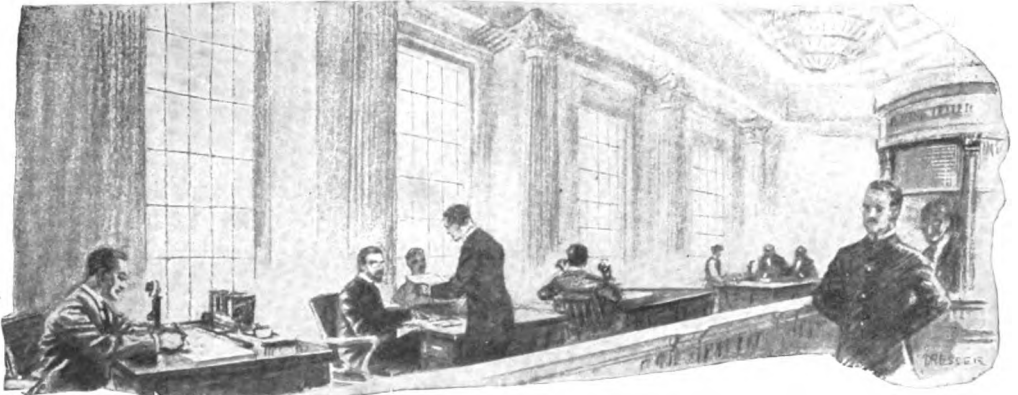

“Trained Men Capable of Filling Important Positions”

In addressing the employees of his institution recently, the president of the largest trust company in New York City said:

“It is becoming increasingly evident that the development of trained men, capable of filling important official and clerical positions in the Company, is not keeping pace with our growth. Therefore it has been necessary frequently, as you know, for us to go outside of our organization for such men.”

Such conditions as these are duplicated by practically every large bank. Many men have been called by the war, while the work of banks have increased. New problems in Banking and Finance require clearer insight. New banking institutions are being organized. All this requires more trained men.

The LaSalle Course In Banking and Finance

offers fundamental training in Practical Banking, and the deeper problems of modern finance for the ambitious man who wants to learn while at home, doing his “bit” the best he can.

If you have the right stuff in you to start with, something of natural inclination and ability in financial lines, the LaSalle Course in Banking and Finance will fit YOU to enter this field and put YOU in line for the big opportunities banking offers now for service, honor and wealth.

This comes of practical instruction in banking which is being highly commended by bankers, has been prepared, and the service in connection with it is rendered, by noted authorities in banking and finance, men who know thoroughly by successful experience the subjects they teach.

Send for the Sixty-Page Prospectus of This Remarkable Course

If you want to become a banker, or if you are in a bank already and want to improve yourself, to get a better grasp on the fundamentals of your business, to make your efforts of greater benefit to your employer, your customers and yourself, the LaSalle Course in Banking and Finance will benefit you out of all proportion to its cost. Set before yourself the goal of becoming a **TRAINED MAN CAPABLE OF FILLING AN IMPORTANT POSITION** in the banking world.

Fill out and mail the Coupon now. The book will go to you by return mail.

LASALLE EXTENSION UNIVERSITY

Dept. 11312

“The World’s Greatest Extension University”

Chicago, Ill.



L A SALLE EXTENSION UNIVERSITY
 “The World’s Greatest Extension University”
 Dept. 11312 Chicago, Ill.
 Please Send me, free, a copy of “Banking and Finance” giving full particulars of your extension (home study) course in banking and finance.

Name.....
 Street and No.....
 City.....State.....



TRADE MARK

A business that isn't scientifically managed today isn't "safe." Competition is keener than ever since the war. It's a case of the survival of the fittest.

Are you sure that the enterprises financed by your bank are run according to the best ideas of modern practice?

The Business Counselor Service offered by this organization to industrial plants and business houses through the banker insures successful administration.

Write today for full particulars

The G. K. PARSONS Corporation

ENGINEERS OF BUSINESS

Equitable Building

New York

standing the big war business a large portion of the new industry is conceived from a standpoint exclusive of the war and its attendant conditions. With the actual construction of a \$5,000,000 exclusively airplane motor plant under way, with other factories turning to the new industry by enlarging their plants and with airplane business on hand totaling conservatively \$100,000,000 it is considered that necessary steps have been taken to establish Detroit as the center of airplane manufacturing just as it dominates American automobile production. Construction work on new and additional industrial enterprises now under way approximates \$50,000,000. The labor supply has been short for a long period and a great influx of new labor is a certainty in order that additional industries may be manned. A reflection of

the natural mid-summer period of semi-lethargy just passed is seen in statistics for the month. Bank clearings decrease is due to the shortage of three working days in September as compared to August. Total bank transactions, however, are exceeding last year's figures by a wide margin. Exports and imports were perceptibly affected by new governmental control of commercial intercourse with certain nations. Optimism now rules in all lines of business where knowledge is had of the tremendous industrial activity prevailing.

**FLOUR CONDITIONS IN MINNEAPOLIS
DISTRICT**

The Northwestern National Bank of Minneapolis in its October financial and business review says with regard to the flour condition:

With the present heavy orders for flour, Minneapolis mills might be running at their utmost capacity if the full requirements of wheat were available. As it is, mills are running somewhat under capacity and grinding everything in sight. The output is greater than it was a year ago. The week ending September 29 shows a production in Minneapolis of 432,605 barrels; the pro-

**BANKS ORGANIZED, FINANCED,
BOUGHT AND SOLD,** everywhere;
ample funds always on hand for good new, or
old dividend paying bank stocks, carrying
official positions. Highest class, confidential
selling and buying service rendered banks,
bankers and investors. JOHN P. JONES,
Monadnock Block, Chicago, Ill.



Mink Lining With Alaska Seal Collar

MEN'S FUR AND FUR LINED COATS
\$25.00 to \$500.00

CLOTH COATS WITH FUR COLLARS
\$25.00 to \$90.00

C. C. Shayne & Co.

Manufacturers of

Strictly Reliable Furs

126 West 42d Street, New York

Ask Your Stationer for
Bankers Linen and Bankers Linen Bond

Made in Flat Papers, Typewriter Papers and Envelopes

They are fully appreciated by the discriminating banker desiring high-grade serviceable paper for correspondence and typewriter purposes

SOLE AGENTS

F. W. ANDERSON & CO.

INCORPORATED

34 Beekman Street, New York

duction of the corresponding week last year was 338,660 barrels, and 487,815 barrels for the same period in 1915.

MINNEAPOLIS BANKERS BECOME RAILROAD DIRECTORS

F. A. Chamberlain, chairman of the board of the First and Security National Bank of Minneapolis, was recently elected a director of the Minneapolis & St. Louis Railroad. F. E. Kenaston, president of the South Side State Bank of Minneapolis, was also elected a director.

STATEMENT OF REDFIELD NATIONAL BANK

The Redfield National Bank of Redfield, South Dakota, opened its doors for business fifteen years ago. To-day

it is a member of the Federal Reserve System and in its statement of conditions as of September 11, 1917, showed total resources of \$1,129,754.55, with deposits of \$1,022,310.91. The bank has a capital stock of \$50,000 and a surplus fund of \$25,000. Z. A. Crain is president.

BANK REPORTS CALIFORNIA CROPS

The Savings Union and Trust Co., San Francisco, in the October number of Savings Union Service, reports local crop conditions as follows:

Just as corn, and cotton also, are racing against frosts, so in California the extent of the harvest of rice, beans, raisins and dried fruits, is contingent on the early rains. Rice suffered last season from the effect of rain, but more experience and earlier planting, it is said, will place the crop in warehouse fully four weeks earlier than hereto-

ADRIAN H. MULLER & SON

55 WILLIAM STREET, Corner of Pine Street, NEW YORK

AUCTIONEERS

The Business of Banks, Bankers, Investors and Dealers in Securities generally, receives prompt and careful attention.

STOCKS AND BONDS AT AUCTION

REGULAR AUCTION SALES OF ALL CLASSES OF STOCKS AND BONDS EVERY WEDNESDAY

Real Estate at Public and Private Sale

Prompt Returns on all business entrusted to us

\$1,100,000
SAVED
 IN HANDLING
2,750,000,000

POSTAGE STAMPS *through*



SEALS · STAMPS AND COUNTS
 250 ENVELOPES PER MINUTE

80% CHEAPER
 than by any
 other method

**MAN
 POWER
 SAVED**

Let Us Show YOU How To Save Money

MAIL-O-METER
 SALES COMPANY
 CHICAGO

MAIL-O-METER
 COMPANY
 DETROIT

MAIL-O-METER
 SALES COMPANY
 NEW YORK

fore. This has been the best growing season for rice in the past four years, and it is expected to gather a bumper crop from the 100,000 acres that have been planted this year. According to the bulletin of the California Development Board, buyers are offering \$3 per 100 pounds for this season's rice, while at the same time last year \$1.50 was the best offer. It is understood that the Pacific Rice Growers' Association will fix a \$4 basis for California rice, the southern mills having already fixed \$4.05 as a basic rate. Conservatively the 1917 rice harvest is expected to be worth \$10,000,000, while so recently as 1912 it returned but \$75,000.

INCREASE OF DEPOSITS IN CANADIAN BANKS

The outstanding feature of the August statement of the Canadian banks was a further increase of over \$23,000,000 in savings deposits, making a total of more than \$950,000,000, which is \$300,000,000 more than when the war broke out. Total assets of the banks amounted to \$2,096,390,662, which compares favorably with the August, 1916, total of \$1,840,895,799.

Thanksgiving Proclamation

"By the President of the United States of America.

"A PROCLAMATION: It has long been the honored custom of our people to turn in the fruitful autumn of the year in praise and thanksgiving to Almighty God for His many blessings and mercies to us as a Nation. That custom we can follow now, even in the midst of the tragedy of a world shaken by war and immeasurable disaster, in the midst of sorrow and great peril, because even amidst the darkness that has gathered about us we can see the great blessings God has bestowed upon us, blessings that are better than mere peace of mind and prosperity of enterprise.

"We have been given the opportunity to serve mankind as we once served ourselves in the great day of our Declaration of Independence, by taking up arms against a tyranny that threatened to master and debase men everywhere and joining with other free peoples in demanding for all the nations of the world what we then demanded and obtained for ourselves. In this day of the revelation of our duty not only to defend our own rights as a Nation but to defend also the rights of free men throughout the world, there has been vouchsafed us in full and inspiring measure the resolution and spirit of united action. We have been brought to one mind and purpose. A new vigor of common counsel and common action has been revealed in us. We should especially thank God that in such circumstances, in the midst of the greatest enterprise the spirits of men have ever entered upon, we have, if we but observe a reasonable and practicable economy, abundance with which to supply the needs of those associated with us as well as our own. A new light shines about us. The greatest duties of a new day awaken a new and greater national spirit in us. We shall never again be divided or wonder what stuff we are made of.

"And while we render thanks for these things let us pray Almighty God that in all humbleness of spirit we may look always to Him for guidance; that we may be kept constant in the spirit and purpose of service; that by His grace our minds may be directed and our hands strengthened; and that in His good time liberty and security and peace and the comradeship of a common justice may be vouchsafed all the nations of the earth.

"Wherefore, I, Woodrow Wilson, President of the United States of America, do hereby designate Thursday, the twenty-ninth day of November next, as a day of thanksgiving and prayer, and invite the people throughout the land to cease upon that day from their ordinary occupations and in their several homes and places of worship to render thanks to God, the Great Ruler of nations.

"In witness whereof, I have hereunto set my hand and caused the seal of the United States to be affixed.

"Done in the District of Columbia this 7th day of November, in the year of our Lord one thousand nine hundred and seventeen and of the independence of the United States of America the one hundred and forty-second.

WOODROW WILSON."

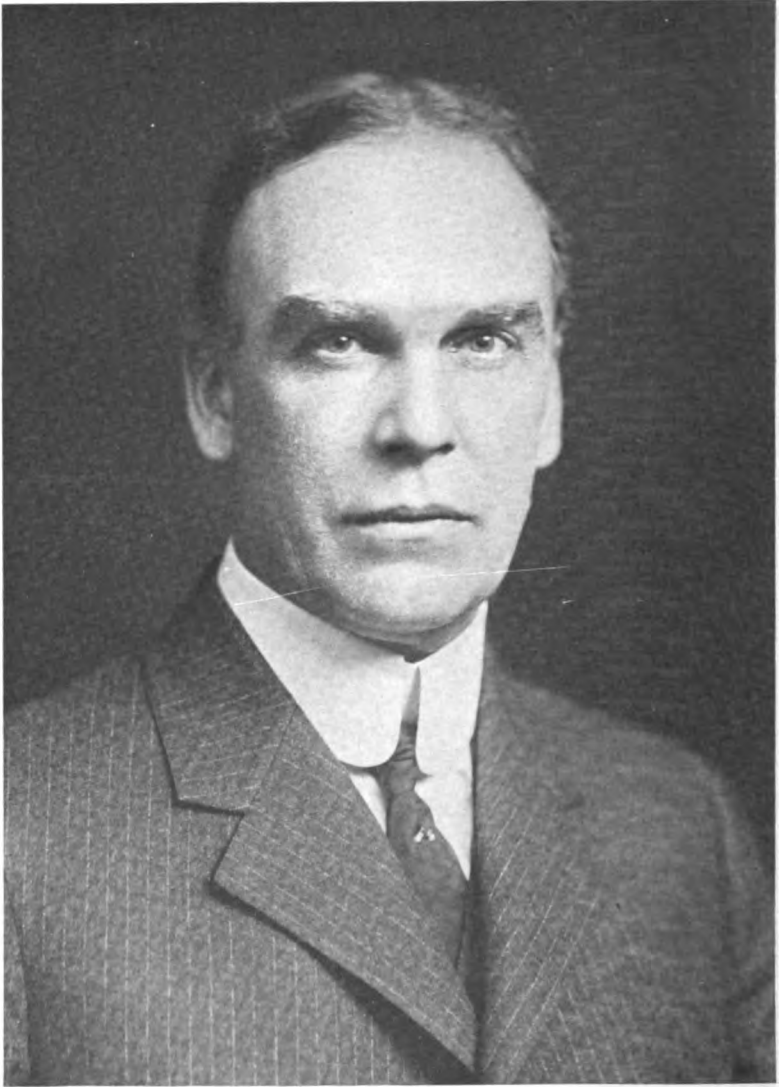

ALFRED L. AIKEN

Newly elected President of the National Shawmut Bank of Boston. Mr. Aiken is Governor of the Federal Reserve Bank of Boston, where he has been conspicuously successful in the work of this important district

See page 814

THE BANKERS MAGAZINE

ELMER H. YOUNGMAN, Editor

SEVENTY-FIRST YEAR

DECEMBER 1917

VOLUME XCV, NO. 6

Winning the War

TO win the war is now the chief business of the people of this country. That the task is one which will completely engage the talents, the industry, the wealth and all the spiritual and physical resources of the nation, recent events make clear.

The factor on which we seem thus far to have placed most reliance is our great wealth. It has been assumed quite commonly, in the discussion of the American attitude toward the war, that the entrance into the conflict of a nation possessed of so much wealth must of itself prove a decisive factor in the great struggle. That wealth which can be employed in the purposes of war is of immense service in a contest of this kind, goes without saying. To assemble, equip, transport and maintain armies and to keep our navy active, money is required in vast amounts. We must not only thus provide for our own forces, but we must also supply money to help in sustaining those allied with us. It is therefore extremely fortunate that the United States possesses so much wealth which can be applied to war purposes.

But this is the extent of the service of wealth in waging war. Our foes are not terrified by the mere contemplation of the vast wealth of the country. Furthermore, if our prosperity has weakened the spiritual and physical character of the people, the advantages already enumerated may be largely counterbalanced. Poor and hardy peoples have conquered before now those steeped in idleness, luxury and wealth. It remains for us to show that the great wealth of the United States has not sapped the spiritual and physical strength of the people. That we shall soon give to the world this demonstration, every patriotic American must fervently believe.

Again, ourselves and those allied with us point to the vast superiority in numbers as an overwhelming evidence that we must triumph in the end. But here again, in war, numbers are effective only as they may be employed for the purpose at hand. Untrained

millions of people are of no use in military operations except as they afford raw material which may be utilized in time.

Could the war be won by the mere quotation of statistics of population, the figures for China and India could be put forth with confidence of producing a speedy end of the conflict.

But population, like wealth, serves in war only to the extent that it is effectively employed. This employment consists chiefly in furnishing men for the army and navy and industrial workers to provide munitions and supplies of war materials, including food, clothing and all necessary equipment.

From the standpoint of war economy, then, the question arises, Are we using our wealth and population in the most effective manner possible?

This is a question of serious import, and it is raised here for one purpose only, namely, by discussion to help this nation in its present supreme object—the winning of the war.

A large part of the country's capital wealth is being devoted to war purposes, but a very large part also is still employed in producing things that might well be dispensed with in times of peace and that imperatively ought to be dispensed with in time of war. Surely, no person of observation and intelligence will ask for a particularization, when he has but to look around him and see the truth of the statement made.

Every dollar employed in a useless industry by so much robs the soldiers and sailors of America and the starving millions of our Allies and enhances the cost of the war in money and in life. When there is not sufficient capital to produce ships, foods and war munitions, you can not use a single dollar for catering to luxury, fashion and frivolity without crippling the men whom we are sending to the trenches and to man the guns of our ships at sea.

The conflict is now at a serious stage, and we need every dollar of capital this country can raise to help win the war. It is urgent that the authorities and every banker should realize this solemn truth and at once take all necessary steps to utilize the country's wealth for war and for war alone. This does not mean that our people shall not have enough of food, clothing and shelter to make them efficient laborers in this great work. But that is the most they ought to have until the war is over.

What has been said about the country's wealth applies as well to its working forces. It may be plainly seen that thousands of workmen are still employed in producing things the community can do without. Every day's labor devoted to such purposes is a loss of so much productive power sadly needed in making guns, ammunition and ships and in producing food and other needed supplies. Human lives will be lost by thousands unless the industry of the

country is turned to the fullest extent possible to producing the things needed to win the war.

Can not many people now engaged in the production of luxuries, and in supplying articles of fashion, or in catering to the follies of the idle and frivolous labor to more effect in helping to win the war? Can not more factories be put on a twenty-four-hour basis, with three shifts of workers, so that production of war materials may be multiplied? Can not the country's idle men and women be compelled to work in some useful industry?

Russia has complained of late of economic weariness. We, too, shall feel it soon unless every bit of our strength in men and money, above that needed to keep the people efficiently at work, shall be devoted to war industries.

This is the most serious question before the people to-day. If we are to win the war, we must get on the job. We must give up everything that hinders us from putting in the field and maintaining there a fighting force which will win a complete victory for American arms.

WORKING OUT OUR PROBLEM

SLOWLY, yet as rapidly as the magnitude of the task permits, this country is turning its energies and its capital from the pursuits of peace to those of war.

In this undertaking, charged with momentous issues to the United States and to the whole world, our people will have to enlist all the powers they possess to help in bringing about a speedy and victorious end to the great conflict.

As one who sets out to win a race must cast aside every hindrance to swiftness and endurance, so must the country in this supreme test of its strength throw away everything that stays its progress to the final goal.

We are not yet stripped for battle. Time, capital and industry are still given to minister to the luxuries and even to the follies of mankind, while almost at our gates lurks an enemy bold, powerful and merciless, whose chains will surely bind us if we do not as a nation rise at once in the full majesty of our power and highly and firmly resolve and act to defend ourselves.

As the ride of Paul Revere summoned the New England farmers to their heroic duty, an appeal must now go forth from every printed page and from every platform that shall warn the people of the

danger that bids them unite as one man in defense of their own hearthstones.

We are either going to win this war or we are going to be beaten, and if beaten, we shall be enslaved.

An ancient conqueror made of a subjugated state this seemingly modest request, that its ruler would send him annually a small piece of turf and a cup of water. But this tribute was the sign of vassalage.

America, denied the right of its citizens to live and to trade upon the seas, will be a vassal state.

This is a condition to which the America of Washington and of Lincoln will never submit.

To the last man and the last dollar we shall uphold our rights.

From this time forth the thought always uppermost in the mind of every American should be this: We must win the war. This, also, must be the object of our every action. All business must be shaped with this end in view. Production and commerce must have for their first purpose the supplying of food and equipment to our own forces and to those of our Allies, keeping for ourselves at home only so much as may be absolutely needed to help in carrying on the war.

Primarily, until the day of complete victory, the business of this country must be war business.

We have already done much in supplying money, munitions and food. We must do more. We have as yet done little on the sea or on the field of battle. Here we must make our full contribution.

One hundred millions of free Americans—men, women and children—should answer to the next demand for money, which might well be called a Victory Loan, and the amount furnished should be not less than ten billions of dollars and as much more as the government wants.

This nation has boasted of its wealth and power. Now comes the opportunity to make good these claims.

In no nobler aim was the power of a free and mighty people ever engaged—to vindicate our own rights, and in their vindication, establish freedom forever for mankind.

LARGE NUMBER OF BANK DEPOSITORS IN THE UNITED STATES

FROM a recent statement made by the Comptroller of the Currency it appears that the 28,000 national, state, and savings banks and trust companies have about 46,000,000 deposit accounts, of which 16,000,000 are in the national banks, 9,000,000 in

the mutual savings banks, 7,000,000 in trust companies, and the remainder in other state banks. These deposit balances range from small sums to as much as \$20,000,000 in a single account.

Although the proportion of savings bank depositors in the United States to the total population has been lower than in other countries, according to accepted statistics, it would seem that our total of bank depositors of all classes is high, amounting as it does to some forty-five per cent. of the population.

As a matter of fact, the commonly-accepted savings statistics are hardly accurate, for they generally omit a number of institutions, which though not savings banks, do substantially perform their function. On the other hand, an inspection of the classes of European banks included will show some institutions which are not savings banks according to the construction of that term common in this country.

But allowing for these and other discrepancies, it may be said that the savings bank deposits for the United States do not make so good a showing as for some of the European countries. Taking all classes of depositors, however, it will be seen that this country is making an extensive use of banking facilities. In fact, the use of the bank check has probably developed to a greater extent here than in any other country, with the possible exception of the United Kingdom. The bank account is no longer a particular mark of distinction. Payment of household bills by check instead of by cash has become all but a universal custom. Farmers were among the last to adopt the practice, but now it has become quite common with them.

Strangely enough, while the United Kingdom by employing the bank check extensively managed to do an immense volume of trading with a comparatively small amount of cash, in the United States our total volume of currency and the per capita circulation have kept on increasing amazingly despite the greater use of the bank check as an instrument of exchange. We have also many kinds of currency in circulation, although in substance the varied forms are the same, because there is no actual difference in value.

THE RAILROAD SITUATION

AS cold weather approaches, with increased difficulties of operation, the possibilities of still further trouble in meeting the demands for the movement of goods are being considered by managers of the important railway lines. That the situation is not satisfactory despite the economies made possible by operating the roads practically as a single system appears from the fact that the

October figures of car shortage are well above those for September. On October 1 the net shortage of freight cars on the lines of the United States and Canada was 70,360, against 34,605 on September 1. Naturally, the Government will have first call on the railways from now on in the transportation of troops and supplies, and if the facilities of the lines were deficient before, they will become more so in the succeeding months. Those charged with handling the transportation problem are making heroic efforts to overcome the difficulties of the situation; but the fact is that the railway mileage and equipment are far behind the needs of the times. Even under the most favorable conditions a deficiency of this character could not be speedily remedied, and under existing conditions it can not be remedied at all—that is in a period of time which will afford the required relief. This is not to say that the railway situation is hopeless, for it is not. Presumably, in the course of time, the business intelligence of the country will assert itself and the necessary steps will be taken for making the railroads again the efficient servants of business that they were in other days.

Probably the inconveniences which business must experience in the next few months will give rise to such a demand for this step as to accelerate the movement for betterment.

Both banking and the railways in this country have at various times experienced public hostility, but in the end what may be called the average feeling of the community asserts itself and legislative and administrative acts take on a more reasonable aspect. This may be expected to be the outcome of the railway problem. In the end the roads will get such legislative or other relief as they actually require to restore their efficiency.

A BILLION-DOLLAR BANK

ACCORDING to the numerical reckoning common in England, they would not say that the London City and Midland Bank, whose deposits have now reached a total of \$1,005,994,265, is a billion-dollar bank. But according to American reckoning it would be given this distinction. Whichever method of reckoning is accepted, the actual figures are not altered, and they place the bank in an enviable position, and one not yet reached by any bank in the United States.

Part of the growth of the London City and Midland Bank has been due to the process of absorbing other banks, which this institution, in common with many others in the United Kingdom, has been following for some time. But a great deal of it may be ascribed

to the development of British trade, finance and industry. Of course, the war has tended to swell the figures of the great joint-stock banks of London.

As quite well understood on both sides the Atlantic, the English banking system differs radically from that of the United States. In England there are only a few large banks, while in this country the banks are quite as thick as the autumnal leaves in Vallombrosa's vales or elsewhere, with not much prospect of a diminution of the number.

It has sometimes been a matter for speculation why the banks of New York did not imitate the example of the London institutions by amalgamating and forming a great bank that would have been preëminent at this financial centre. Such a bank would have overshadowed the combined Federal Reserve Banks, and might even have forestalled their organization. Possibly the adoption of the policy indicated has been prevented by the tenacity for power which the president of a New York bank feels. However this may be, the policy of consolidation has been carried out to a far greater extent in London than in New York, and has given the former city a bank much larger than the latter can boast.

The fact that one of the London banks has attained the size which the figures given indicate is a fresh demonstration of the remarkable degree of safety and skill displayed by that city in handling banking on a large scale. From the solid foundations laid in the past, and upon which the immense credit structure of the present has been built, not even the cataclysmic war could dislodge the great English joint-stock banks.

The London City and Midland Bank has for its chief executive Sir Edward H. Holden, Bart., who is not only an eminent banker but a distinguished economist whose views universally command attention and respect. He stands well at the front among bankers of the present day, and his friends in America will feel satisfaction in learning that the great institution he so worthily directs has reached a foremost position among the banks of the world.

CENTENARY OF THE BANK OF MONTREAL

LAST month marked the centenary of the Bank of Montreal, which was established November 3, 1817. For many years the bank has held a leading position among the financial institutions of the North American Continent and has numbered among its executive officers men of eminence in banking and statesmanship.

How rapidly the Bank of Montreal has grown in the last fifty years may be seen by comparing some of the items of the balance-

sheet a half century ago with those of the present day. At the date of the fiftieth anniversary in 1867 the total assets were \$19,787,499; now they are \$386,806,887; total deposits have grown from \$11,198,831 to \$324,144,279; capital from \$6,000,000 to \$16,000,000, and reserve from \$1,250,000 to \$16,000,000.

In point of capital equipment the Bank of Montreal has long maintained a strong position among the banks of North America.

Canadian banking development has been along the lines followed by the banks of the United Kingdom rather than those of the United States. In Canada as in England there are a few great banks with large capital and having numerous branches, compared with numerous banks in the United States with but few branches. The chartered banks of the Dominion of Canada have displayed great adaptability to the demands of production and trade in ordinary times and at periods of crisis they have acted with patriotism and rare discretion. They have kept the banking and credit systems sound and efficient and have been of immense service in contributing to the country's development and prosperity. In their bank-note system especially they have shown the great value of an elastic circulation in carrying on the operations of producing and marketing commodities.

The Bank of Montreal, both on account of its size and age, enjoys a leading position among the banks of the Dominion, and has won its place by the wise leadership of those who have formed and carried out its policies in the one hundred years of its existence. Aside from the usual banking functions, which have been discharged with exceptional fidelity and ability, the bank has not infrequently acted in a way to steady the financial relations between Canada and the United States. Its branches in New York, London and other important centres afford vantage points from which international banking operations may be carried on. The many services which the Bank of Montreal has rendered to the people of Canada fully entitle the institution to the position it occupies to-day. Whether Canada will grow as rapidly in the next fifty years as in the past half-century or not, the bank is sure, if not to duplicate its increase from 1867 to 1917, to continue to advance in size and prosperity and to maintain its present unassailable strength.

KEEPING UP THE VALUE OF SECURITIES

AN intense interest has been felt by the banks of the country in the continued fall of high-grade securities of various sorts. This decline in price has of late reached a point where it naturally occasioned considerable anxiety to the banks, since they held

a large volume of such securities. They were much relieved by an announcement, made by the Comptroller of the Currency, to the effect that national bank examiners, in making examinations of banks, had been instructed not to value thoroughly good securities at present depressed prices, but to use a sound discretion in the matter.

Undoubtedly this action of the Comptroller is wise under existing circumstances, and will tend to allay any apprehension that might have been caused by the heavy fall in value of even the best securities.

This same problem has been encountered by the great joint-stock banks of England, which have been compelled to write down the valuation of their securities to an extent that has cut quite severely into their earnings. In neither case was this situation due to a lack of sound banking judgment, but grew out of conditions which human prudence was powerless to avoid. It would seem, therefore, that the banks should not be expected to provide for these losses in a short period, and especially since in many instances there may be a recovery in the value of securities that will go far towards counterbalancing this loss.

So far as the banks of this country are concerned, the Comptroller of the Currency evidently feels that inasmuch as their losses have been in part caused by Government competition for investment funds, the Government can not call the banks to account for a situation which it has been partially instrumental in creating through its own necessities.

SUCCESS OF THE LIBERTY LOAN

THE second Liberty Loan has turned out a complete success. While only \$3,000,000,000 was asked for, the subscriptions received aggregated \$4,617,532,300, or an excess of fifty-four per cent. In accordance with the terms of the offer of the loan, subscriptions up to \$50,000 will be accepted in full, and others at various percentages of the subscriptions. Under this plan, the amount of subscriptions the Treasury accepts is \$3,808,766,150. The number of subscribers to the loan was 9,400,000, and about ninety-nine per cent. of the subscriptions were in amounts ranging from \$50 to \$50,000. As Secretary McAdoo says, "The success of the second Liberty Loan, like that of the first, is a distinct triumph for the people of the United States. It not only demonstrates their ability,

patriotism and resources, but augurs the certain success of any future loans that may be offered by the Government."

Every one of the twelve Federal Reserve districts turned in excess subscriptions, as shown in the accompanying table:

	TOTAL SUBSCRIPTIONS RECEIVED	ALLOTMENT	% OF OVER- SUBSCRIPTION
Boston	\$176,950,005	\$300,000,000	59
New York	1,550,453,450	900,000,000	72
Philadelphia	380,350,250	250,000,000	52
Cleveland	486,106,800	300,000,000	62
Richmond	201,212,500	120,000,000	68
Atlanta	90,695,750	80,000,000	13
Chicago	585,853,350	420,000,000	39
St. Louis	184,280,750	120,000,000	54
Minneapolis	140,932,650	105,000,000	34
Kansas City	150,125,750	120,000,000	25
Dallas	77,899,850	75,000,000	4
San Francisco	292,671,150	210,000,000	39
Total	\$4,617,532,300	\$3,000,000,000	54

Without any attempt to forecast the Government's future financial programme, the opinion may nevertheless be ventured that subsequent loans, as they become necessary, will be taken with probably greater facility than in the case of the first and second loans. The intensive campaign of education carried on in the newspapers and from numerous public platforms has had a tremendous effect in stimulating a patriotic impulse on the part of people who can not themselves directly participate in the war to do what they can to help in winning victory by contributing the needed funds.

The educational effect of the campaign in multiplying the number of investors has also been marked. Many thousands, and perhaps millions, of Americans, wholly unaccustomed to the making of investments on their own account, have subscribed for the Liberty Loan. Having learned how simple is the process of becoming an investor, they are reasonably sure to subscribe for future loans in even larger amounts.

Some compensations grow out of war, and it will be of considerable benefit to the United States, and very likely to other countries as well, that a very large body of new investors has been created through war financing. It may be anomalous that only through the waste of war people learn to become savers, which perhaps is but another illustration of the fact that the lessons of experience are not usually easy, though it must be conceded that this one is rather more difficult than usual.

The result of the Second Liberty Loan may be taken as an evidence that this country is financially awake, and that whatever

sacrifices may become necessary to provide abundant means for prosecuting the war, they will be made. Whether the industries of the country may not soon have to adjust themselves more completely to a war basis than they have yet done, is now being considered by the authorities, and in addition to this step we shall probably soon have to pare down our expenditures at many points where savings can be made.

Despite the intensity of the recent campaign, and the strong efforts put forth to make the loan as large as possible, it may be said with confidence that the capacity of the people for making subsequent loans remains ample.

INCREASED NUMBER OF INVESTORS

IT has been frequently stated by financial writers that this country does not have a large body of trained investors, such as may be found in France and Great Britain. This statement is no doubt true, but probably will not be in the near future, for the immense amount of publicity given to the Liberty Loan is stimulating interest in investments and multiplying the number of investors.

Estimates have placed the number of subscribers to the first loan at a total of 4,000,000, and nearly 10,000,000 for the second loan.

Doubtless many of those who subscribe for the loans become investors for the first time. From buying Government bonds to buying other high-grade securities is not a long step, and it may be expected that the Liberty Loan campaigns will have an important effect in creating a large permanent class of investors in this country.

Such a development would be regarded by the bankers as particularly fortunate. Mr. Morgan's famous epigram, "undigested securities," put in a striking fashion the truth that the banks of the United States sometimes became heavily loaded with investment securities. Could the banks pass more of these securities on to their depositors and others, the danger of indigestion would be reduced by the fact that the number of consumers would be increased and the likelihood of overfeeding correspondingly reduced.

For the domestic and foreign financial obligations which the United States must shoulder for some time forward, we shall need an investing public with almost unlimited powers of absorption, and it is well that the process of training such a body of investors is now going on and that the educational process is to an extent compulsory—a fact which may be relied on to speed up the process.

That the broadening of the investment market resulting from the change referred to may have an important effect on the financial and economic status of the United States is reasonably certain, and it may also result in more tolerant views in regard to capital and wealth on the part of the average member of the community. That the latter effect would tend to modify to an important degree the legislative policy toward corporate enterprise is a probability at least.

UNITING ALL THE BANKS THROUGH THE FEDERAL RESERVE SYSTEM

AN appeal has been made to all the banks of the United States to join the Federal Reserve System. This appeal is based not so much on direct advantage to the banks themselves as on grounds of patriotism.

In the January, 1915, issue of *THE BANKERS MAGAZINE* it was pointed out at some length the advantages that would accrue to the country by having all the banks come together for certain purposes, and methods were suggested for inducing the banks to join the Federal Reserve System. These methods were persuasive rather than compulsory. National banks were forced into the system, but as this drastic process could not be employed in the case of state banks, the suggestion was made that more sweet and reasonable means be employed. Nevertheless, the forcing process was resorted to, but with poor success. Lately this policy has been discarded, and the banks have been invited quite politely to come into the new system. Many have done so of late, the additions including several trust companies with large resources.

On many grounds, under present conditions, it is desirable that the banks of the country should be united for certain purposes at least. The state banks may come into the Federal Reserve System without losing their state charters and with certain other advantages conferred by recent amendments of the Federal Reserve Act or by a more tolerant interpretation of some provisions of the law.

Such faults as may be developed in the Federal Reserve Law in operation would probably stand a better chance of correction should all the banks become members, for all the banks of the country, acting together, would exercise an important influence on legislation, very much greater than could be exercised by the comparatively limited number of banks now comprising the Federal Reserve System.

When President Wilson asks the banks to join the system on

patriotic grounds, he presents an appeal which many of them will find it extremely difficult to resist.

REDISCOUNTING NOT YET POPULAR

FROM the most recent compilation of returns of the national banks it appears that rediscounting is not yet popular with those institutions, notwithstanding the fact that some leading bankers have been urging them to take greater advantage of the rediscount privilege which is afforded by the new Federal Reserve System.

Although on September 11, the date of the last report, the national banks of the United States had loans and discounts aggregating \$9,055,000,000, their bills payable and rediscounts amounted to but \$285,000,000, which was a reduction as compared with June 20, 1917, of \$88,000,000, but an increase as compared with September 12, 1916, of \$193,000,000.

A tradition among American bankers that "overdrafts" and "bills payable and rediscounts" do not look well in their balance-sheets is largely responsible for the slow growth of this item. Evidently, if one of the supposed chief benefits of the Federal Reserve System is to materialize, this tradition must be lived down. Possibly these items, called by some other name, might lose the present psychological objection which attaches to them.

It seems probable that many banks will rediscount quite liberally in order to aid their depositors in making subscriptions to Government loans, and it would not be surprising if future reports show a material increase in this item. The objection to rediscounts is among the banks themselves and not on the part of the Comptroller of the Currency, although this official does not look leniently upon "overdrafts."

THE COUNTRY'S NEW FINANCIAL RESPONSIBILITIES

IN measuring the degree of efficiency shown by the banks of this country in discharging the financial responsibilities devolving upon them since the beginning of the war, the magnitude of these responsibilities must be taken into account. For this great task of international financing the American banks were not well equipped. At New York and some other centres there were a few

great banks with more or less experience in the foreign financial field. But few of them had made large permanent investments abroad, though some had made temporary loans to Europe and other parts of the world. The national banks of the country were without branches, and there was hardly any banking organization operating in the foreign financial field which was broadly representative of the spirit of American banking. The banking system had been for years composed of numerous scattered banking units not coördinated for any united policy which might be desirable or essential.

In the face of these difficulties, the banks of the country were called on suddenly to perform unheard-of prodigies of finance. They met each one of these difficult situations with courage and with complete success. Gradually, under the Federal Reserve System, some of the difficulties mentioned have disappeared, and the banks of the United States have been placed in a position where they may obtain a fair share of the world's banking.

The banks at present are somewhat restricted in fulfilling their new duties by the immense demands made upon them by the Government. In time these restrictions will disappear and the banks of the country will have a fairer field in which to operate.

JAPAN AND THE UNITED STATES REACH AN AGREEMENT

THE agreement recently signed by Secretary Lansing, for and on behalf of the United States, and Viscount Ishii, representing the Imperial Japanese Government, marks a most important stage in the diplomatic history not only of the two nations immediately concerned, but of the entire civilized world. Perhaps, when the history of the present war comes to be written, it will be recorded that, next to our actual entrance into the contest, the two most significant events of the whole war, so far as this country is concerned, consisted in the apparently simple and sentimental ceremony of laying wreaths on the Tomb of Washington at Mount Vernon by Mr. Balfour of England and Viscount Ishii of Japan. In making this statement, the momentous events of the great conflict are not forgotten. But it will be found, when the war ends, that one of its very great achievements was the removal of distrust from the minds of the people of the United States toward Great Britain, and the substitution of friendly coöperation between Japan and the United States in place of the suspicion and covert hostility

that had long existed. These momentous changes were symbolized in a solemn and fitting manner by the simple but impressive ceremony at Mount Vernon.

Friendly as had been the relations between Great Britain and the United States, some leading American statesmen were long of the opinion that it was but a matter of time when the economic interests of the two nations were bound to clash to an extent beyond the power of diplomacy to reconcile. It is unnecessary, in view of recent events, to state the grounds for this belief. It is enough to say that the possibility of such a clash has passed away and perhaps forever. Great Britain and the United States have at last come to realize that the interests of both countries can best be conserved by a policy of mutual coöperation, and on this basis the two nations have made a compact which will not lightly be broken. At the present time they are making common cause, on the battlefield and on the sea, in one of the most terrible conflicts the world has ever witnessed. Standing thus together in the hour of danger and adversity, the two peoples can not be dissevered when brighter days shall dawn.

In the case of Japan the situation was far more ominous. There was practically no probability of immediate and serious differences between Great Britain and the United States, but several times in recent years, troublesome questions have arisen between Japan and the United States, which called for the exercise of the most adroit diplomacy in their settlement. The threat of war has been heard more than once.

At the bottom of the distrust between these two nations lay the policy of Japan toward China. It was feared in this country that Japan aimed either at actual sovereignty over China or meant to set up exclusive trade privileges in that country, thus repudiating the open-door policy previously agreed on. The notes exchanged recently between Secretary Lansing and Viscount Ishii set such fears at rest, for Japan expressly reaffirms the open-door policy with respect to the Chinese Republic. On the other hand, the United States concedes that Japan, on account of her position, has special interests in China, to be exercised in fairness to the other nations of the world.

To discuss all the matters involved in this important diplomatic agreement is outside the scope of a purely financial journal. It may be said, however, that Japan has gained from the United States a recognition of rights to which she was clearly entitled by the intelligence and industry of her people and the faithful observance of her international obligations. On the other hand, the United States need have no fear of being excluded from trading in China and aiding in the financial and industrial rehabilitation of that coun-

try. It may be expected that in the latter work Japan and the United States will cooperate as rapidly as circumstances will permit.

But while the economic effects of this compact are important, of far greater significance is the influence of the agreement both upon the military policy of Japan in the present war and upon the future history of the world. It is a fact of the utmost importance that Japan, Great Britain and the United States are now in substantial accord. If they possess the enlightenment that will cause them to preserve this policy of cooperation, which may be safely predicted, the peace and prosperity of the world in future years should be more easily maintained than heretofore.

To this MAGAZINE the signing of the agreement between the two countries is a matter of the greatest satisfaction, for it has been the belief that the true interests of Japan and the United States consisted in a policy of cooperation. May the compact thus solemnly made endure forever, to the mutual benefit of both peoples.

Reciprocity in International Banking

IN the November number of the MAGAZINE some views of foreign bankers were presented regarding the advisability of taking off certain restrictions in the banking laws of New York relating to the business of branches of foreign banks. Below are presented the opinions of agents of two other foreign banks, who prefer not to have their names used:

"While we would welcome a modification of the New York banking laws to permit of our accepting deposits, we do not aim to compete with your institutions for domestic business of this class, nor do we consider ourselves in a position to do so, and it is not therefore a matter of particular concern to us.

"Viewing the question from your standpoint, we might say for your own information that we consider it desirable that foreign banks should be encouraged to establish agencies here, since they serve to enhance the importance of New

York as a financial centre, and they provide facilities for the handling of your foreign trade. The importance of the establishment of branches of your own large banks in foreign fields in the development of export business must also be recognized and, as very pertinently pointed out in your article, it is not to be expected that foreign countries will continue to grant your banks privileges which are denied to their institutions here."

* * *

Another representative of an important foreign bank writes as follows:

"In the past few years a great deal has been done to foster our foreign trade. Quite at the beginning of the movement it was recognized by the more progressive that success would require adequate American banking facilities in those countries where the expansion of our foreign commerce was desired. Under considerable difficulty our

foremost banking interests responded to the need as soon as our laws were modified enough to allow it. But the final stone is yet to be laid; without it, the whole edifice may, under certain conditions, be deprived of its usefulness. Without a change in our banking laws, which will give to foreign banking institutions at least the same rights that our banks already enjoy by law in the respective countries, the trade which we hope to build up may be deprived of the one instrument which it cannot forego.

"In our banking, as in our mercantile relations with other countries, we must expect to be reciprocal. If we will not go the limit and establish the open door policy, which many believe would be best even for our banking interests, we must at least adopt a policy to give and take. It may be wise to negotiate treaties covering international banking relations as we do commercial ones. In any case, the matter must soon be given careful consideration. Generally speaking, it is safe to say that the branches established by our banking institutions, many of them some time ago, have been welcomed by the respective countries and permitted to enjoy much the same rights as their own. On the other hand, our laws are excessively restrictive and may be considered as calculated to discourage the establishment of branches of foreign banks in this country. Possibly, without this great war the restric-

tion would not have been seriously felt. To-day, however, the financial center of the United States has become one of the most important centers of the world and foreign business interests are ever more acutely feeling their need of getting into closer touch with us. In the same way that we felt the need of our banks reaching out into foreign countries if we would further our trade abroad, they feel the need of approaching us in a like manner. As they do so, they are perplexed to find that we are not at all reciprocal in this respect. They hesitate to subject themselves to such restriction, and quite naturally it occurs to them that they might resort to similar restrictive legislation in order to obtain equal rights. In one South American country, at least, there is even a probability that branches of foreign banks will be legislated out of existence.

"Let us look the fact squarely in the face and inaugurate a policy more in keeping with our recently acquired importance as international bankers. Let us open the door. It is the sign of the times. International boundaries are fading into invisibility through speedier means of communication, and the relations between nations must ever become more reciprocal. A state of war is holding the movement in suspense, but once peace is declared, the forward stride toward fusion will become doubly rapid."



Are School Savings Banks Worth While —To the Banker?

By AUGUSTUS LUDWIG

THRIFT and conservation are words heard in every town and city at present. From all sources, municipal, state and national, comes the appeal to save, to economize, to conserve. And yet, how much of this teaching will produce results, other than a spasmodic attempt at retrenchment due to the influences of the chaotic conditions brought about by the war? How much of the propaganda for the encouragement of thrift will hold over for at least a brief period after the war? You cannot change the ideas and the ideals of a people over night and no amount of legerdemain will suddenly transform our people into a nation of thrifty and wasteless citizens.

In order to produce and evolve a virtue for a whole people, one that will be a part of its citizenship, we must go to the school and begin with the children.

When the authorities of the state agricultural schools wanted to introduce reforms in farming and stock-raising by the use of tested, scientific methods, they enlisted the boys and the girls through the agency of the rural schools, and many a youngster, as a result of this teaching, has raised crops that has put the father's haphazard methods "in the shade."

The history of the evolution of the school gives added proof from another point of view. Chronologically, the universities are the oldest organized secular schools; later, the colleges; then the high schools and in the course of decades there came the elementary schools, and comparatively recently, the kindergarten. But even the latter did not make use of the child early enough.

Pre-kindergarten or nursery schools have been tried. The inevitable conclusion is, that in education, we must begin as soon as it is practicable to do so—and that means almost as soon as the child can profit by the instruction, i. e., approximately when he is four years of age.

The banker, on the other hand, has been content to teach the elements of his business to adults only, neglecting in the meantime the unusual opportunities offered by teaching the children. What proportion of our adult population make use of the savings bank? What proportion understand its function and its method of doing business? How successful has the teaching of the banks been in leading people to use them? To put it another way, how successful has the savings bank been in inculcating the elements of thrift in the life of the community?

A MODERN EDUCATIONAL TENDENCY

One pronounced modern tendency in education is to introduce into the elementary school the rudiments of those processes in our daily occupations that are common to a large group of the community. The curriculum of the school a century ago consisted almost entirely of reading, writing and arithmetic. No one could get along at that time with any degree of success without that fundamental knowledge, but we are beginning to realize that that is not enough. The modern course of study is being enriched by the heritage of the past; so that in the modern school, there will be subjects of study, representative of our scientific, literary, in-

stitutional, aesthetic and religious inheritances. Within this five-fold contribution will be grouped all the material of instruction of the modern school, from the kindergarten through the university, but each of these phases has not been developed to an equal extent. Except for the teaching of the broad principles of ethics, the public school has not trespassed upon the religious inheritance; on the other hand, the literary contribution has been over-emphasized with the result that book knowledge has dominated the entire curriculum. Slowly but steadily, however, the practical arts have been introduced so that to-day we have one or more of the following activities: various shops and studios in which the child learns to do by doing—shops for work in wood and iron; domestic science including dietetics, practical nursing and housekeeping; sewing, including simple design of costumes and millinery; drawing and design as a basis of the decorative arts; and in the pre-vocational schools in New York City, the elements of tinsmithing, plumbing, electric bell wiring and installation, machine shop practice, etc.

Shall the banker stand aloof and reserve his teaching for adults only, when the opportunity is before him of inculcating the essentials of banking in the minds of the children of the nation as a basis for future growth and development?

The school savings bank is no longer an experiment. As a matter of fact, among school men and women in supervisory positions, its inestimable value and the urgency of its need are assumed. It needs no argument. The only question is how shall we proceed to install the school bank with economy of time and energy on the part of the teacher and with proper coöperation of the local state savings bank? One principle should be insisted on: the school bank should be conducted as nearly like a regularly supervised state bank as possible.

Mr. M. W. Harrison, secretary of the Savings Bank Section, American Bankers Association, 5 Nassau street, New York City, will give much useful infor-

mation on the various plans in use in school banks. The schools of New York City have a supervisor of school savings banks, Mr. A. N. Clark, Hall of Education, Park avenue and 59th street, New York City, who will cheerfully furnish data regarding the pronounced success of the installation of banks in over two hundred schools of the city, and more are being started every week. Under the direction of Mr. Clark, arrangements were made for the furnishing and printing of stationery and supplies for the entire school system, with a resulting low cost. The initial supply has in the past been furnished free; subsequent material is delivered at cost price and is usually paid for by the school out of the interest earned by the aggregate deposits in the state bank. Almost all the school banks in the city are self-sustaining in that the expenses for supplies have been met from the interest fund.

The Bank of Manual Training High School, Borough of Brooklyn, New York City, was one of the first organized in the city high schools with the idea of reproducing the essentials of a state bank. It has an office for conducting its business with three tellers' windows, a large safe, filing cabinets, pass books, etc. In addition, a board of directors of seven—three students, three teachers and the principal—supervise the bank with the aid of the usual committee of management, examinations, executive, etc. The offices of president, vice-president and secretary are held by students. They are selected by the board of directors from a staff of over twenty student clerks. A set of by-laws modeled on those of nearby savings banks complete the organization. Since February, 1914, over \$12,000 has been deposited by students, in amounts from five cents upwards, the average deposit being about twenty cents. It is the consensus of opinion among the faculty of one hundred and forty men and women that the school bank is one of the most valuable of the more than forty activities conducted by the general organization of the school.

The time is coming when every school

house will conduct a savings bank as part of its regular work, where the pupils may learn the value of thrift by actually depositing their pennies and nickels themselves. When a pupil has a total deposit of at least five dollars, he should be encouraged to open an account in his own name in a state savings bank, and then begin to save his

second five dollars in the school bank. A child who has learned this lesson will become a depositor when he is an adult. In this way, the school will do its share in teaching the lesson of thrift to all the people, which means more business for the banker, more savings for the people, and more resources for the nation.



The Future of the South

By EDWIN BIRD WILSON, PRESIDENT EDWIN BIRD WILSON, INC.

THE problem of the South's future, is how to develop the God-given resources which enrich its mountains and valleys and streams and harbors. The possibilities of wealth are there beyond the dreams of the most imaginative. All that is needed is intelligently applied capital; that is, capital and organizing ability in team work with industrious labor. The need of the South is for captains of industry and finance from all other sections to cooperate with Southern captains of industry and finance in harnessing its tremendous water power; to build iron and steel plants to make its wealth of ores into bridges and ships and rails and machinery; to build textile mills to spin and weave its billion dollar cotton crop; to buy farms now unworked for want of capital and to cultivate them by modern scientific methods which will cause the fertile soil to bring forth the wonderful harvests of which it is capable; to help in the profitable work of reclaiming wet lands which are heavy with the fertilizing deposits of ages and need only scientific drainage to make them produce enormously.

THE SOUTH NEEDS CAPITAL

The South wants small capitalists, thousands, yes, millions of them, to enrich the South by bringing to it what counts for more than their money—their energy and ability. It wants men

and women of good character, though small capital, to acquire little farms and cultivate them intensively, to build little homes and barns this year and additions next year, finer homes and bigger barns the year after. It wants men and women discouraged by uneven struggles against climatic conditions and short growing hours to migrate to the South and take advantage of the wonderful climate and long growing season. It wants scientific men from all sections of the country to collaborate with the scientists of the South for the comprehensive, sane development and conservation of the South's great natural resources.

A STRATEGIC GEOGRAPHICAL POSITION

The South wants men of ability, means and vision to develop its commerce with Central and South America, to take advantage of its wonderful harbors and its unequalled strategic geographical position created by the opening of the Panama Canal. It wants men who will improve its railroad facilities and open to the markets of the world now isolated, rich three-crop farms, its wonderful diversified mineral deposits and its ever growing manufactories; it wants men who will enrich themselves directly and the South indirectly by building fleets of ships to carry its commerce on its thousands of miles of water highways.

Banking and Commercial Law

CASE COMMENT AND REVIEW

The Woful Ignorance of Bank Employees

THE editor of this department has repeatedly gone on record as an advocate of education for bank employees, with the end in view not only that more intelligent work would follow, but that safer work would result from intelligent work. It is admitted that "knowledge is power", and the man who knows is the man who gets the coveted monetary reward; but when a bank clerk succeeds in spite of ignorance, we are apt to conclude that the spending of time, effort and money in self improvement is unnecessary in some cases.

A few instances of recent happening will illustrate the point that no matter how clever a clerk may be with his hands, his head needs attention as well, if he is to prove a safe as well as a swift employee.

In conversation with the writer a few weeks since, the teller of a busy and growing national bank disclosed the fact that he thought national banks were "backed" by the Government, and were therefore better than other institutions. Here is a fellow who has made good, grown from office boy to teller in five years, increased his income three hundred per cent. and yet is ignorant of the first principle of national banking. How can he expect his patrons to know much about banking if he knows so little? Would it be safe to allow him to use his own judgment in handling notes, drafts and checks, with all their legal consequences, if he has progressed no further than that in five years?

Another: A clerk in posting a deposit made by a depositor named "A. Brown, No. 2," credited the amount to

"A. Brown, No. 1," there being two names of the same kind on the books. He did not know that if "A. Brown No. 2" had drawn a check which would have been good had the error not been made in the posting, and the check had been returned, thus injuring the credit of the drawer, the bank could have been sued and damages awarded. Knowing the legal side of such a matter he might have double care in entering all items on such accounts.

The verification of signatures and indorsements in many banks is left to mere boys, with untrained minds and amidst many distractions, and who will question the risk that is involved in such work? Considering the vast number of possible dangers that banks are confronted with every day, the wonder is so few losses result, and that any profit is left for the stockholders when the accounts are cast up at the end of the year.

Every bank manager cannot run a school of banking and give his employees an education in economics and law, but he can be so well informed himself that he will appreciate the danger spots and give warnings that should be heeded. And it cannot be too often repeated, that in no way can a bank executive gain a better working knowledge of banking than by reading at least the syllabus of the cases that appear in the courts from time to time involving points of banking law and practice, and this habit if kept up for a period of time will accomplish its very evident purpose of making bank men cautious by giving heed to the stumbling blocks over which other banks have tripped. Banking may be nine-tenths common business sense, but the other tenth is banking law, and here is where the law suits and losses are either in-

vited or guarded against. With a banking education to be had for the mere taking in many places, and at best for a trifling sum, no bank man has a plausible excuse for not acquiring the technique of banking from those qualified to teach.

Leading Cases

Uncollected Funds

U. S. COURT

Deposit—Agreement in Pass Book

U. S. District Court of New York, S. D.,
July 14, 1917.

IN RE. H. & L. JARMULOWSKY

Where checks indorsed in blank are deposited with a bank, and an immediate credit is entered in the passbook to the depositor, the checks at once become the property of the bank, but the bank's right to the checks depends upon the depositor's immediate and unconditional right, not merely as a favor, to draw upon the deposit, and, if the depositor did not have such right until collection, the bank did not become the owner; hence a bank does not become the owner of checks deposited with it, where the passbook expressly declared that deposits of checks should not be drawn against until collected.

Where the passbook of a depositor declared that deposits of checks should not be drawn upon until collection, the bank does not become the owner of checks deposited with it, unless such rule is expressly waived, and the depositor given the right to draw at once, though the depositor may be allowed to draw on such deposits as a matter of grace.

In bankruptcy. In the matter of the bankruptcy of H. & J. Jarmulowsky. Ex parte petitions by Benjamin Bortz and Attie Bros., opposed by the receiver. Order for petitioner on the Bortz petition, and for reference on the Attie Bros. petition.

This cause comes up upon petitions by depositors of two private bankers hitherto doing business in the city of New York, under the following circum-

stances: The petitioners opened accounts with the private bankers some time before May 10, 1917, on the opening of which they received passbooks which contained as part of the conditions under which the account should be kept, the following language: "Deposits of currency or coin may be drawn against after deposit, but deposits of checks shall not be drawn against until collected." On the 10th of May the depositors deposited certain checks in their account with the private bankers and received immediate credit in their passbooks for the same. The checks were in each case drawn by persons other than depositors, and were made payable, some in the city of New York, and some without. Nothing appeared on the deposit to indicate whether or not the depositor was to have the right immediately to draw upon the checks, and that question is to be determined upon the bare facts as stated. On May 11, 1917, the bank examiner of the state of New York took possession of the assets of the private bankers, who never opened their doors after May 10th. The checks so deposited on the 10th were not collected until the 11th or later, and the petitioners now claim that the bankers received them as trustees, and for collection only, and that they are entitled to the proceeds of the collection in the hands of the receiver.

The respondent, who is the receiver, appointed after the state superintendent of banks took possession, files an affidavit alleging that the rule contained in the passbooks was expressly waived by one of the petitioners, Attie Bros., and that it was customary for the bankrupts to allow their regular business customers to withdraw money against uncollected checks. The petitioners likewise allege that the bank was insolvent, and known to the private bankers to be insolvent, on May 10th, when the checks were received.

STATEMENT OF FACT AND OPINION

Learned Hand, District Judge (after stating the facts as above). The question as stated in St. Louis & San Fran-

cisco Railroad vs. Johnston, 133 U. S. 566, 576, is in principle only a question of fact; i. e., whether the bank, on receiving the check, intended to become the owner and give the depositor an immediate credit, or whether the intent was that the bank should hold the checks for collection, and that the depositor should have no credit until the proceeds were received. It is pretty generally accepted law that, where nothing appears but the receipt of the checks indorsed in blank or for deposit, and an immediate credit in the passbook to the depositor, the checks at once become the property of the bank and cannot be followed. Metropolitan National Bank vs. Loyd, 90 N. Y. 530; Lyons vs. Union Exchange Bank, 150 App. Div. 493; Cragie vs. Hadley, 99 N. Y. 131; St. Louis & San Francisco R. R. Co. vs. Johnston (C. C.) 27 Fed. 243; Brooks vs. Bigelow, 142 Mass. 6. The bank's right, however, depends upon the depositor's immediate and unconditional right and not merely as a favor, to draw upon the deposit, and if it appears that the depositor did not have such right until collection the bank does not become the owner. Scott vs. Ocean Bank,, 23 N. Y. 289; King vs. Bowling Green Trust Co., 145 App. Div. 398; Beal vs. Sommerville, 50 Fed. 647, 1 C. C. A. 598, 17 L. R. A. 291; Re State Bank, 56 Minn. 119, 57 N. W. 336, 45 Am. St. Rep. 454; Balbach vs. Frelinghuysen (C. C.) 15 Fed. 675. Beal vs. Somerville, supra, indeed, throws a little doubt upon the general rule, and seems to imply that the presumption is that the bank receives for collection unless the contrary appear. Where the checks are indorsed for collection only the case is, of course, beyond any question; for example, in Balbach vs. Frelinghuysen, supra, where the indorsement was for collection, but the depositor could draw at once, the indorsement prevailed.

Applying these rules to the case at bar, it is quite clear that the private bankers would have become the owners of the checks at once, but for the provision in the passbook, "Deposits of checks shall not be drawn against until

collected." In Attie Bros.' case, the receiver alleges that this provision was waived and that the depositor was expressly given the right to draw at once. It will not be enough, however, merely to show that the bank had permitted the depositors to draw. Nothing short of an agreement, express or implied by the course of dealing, to modify the passbook, will answer. On this issue of fact the receiver is entitled to be heard, and there must be a reference. At the time of the reference, if the receiver makes good his claim that the provision in the passbook was expressly modified, it will have to be determined whether the private bankers were insolvent, and knew of their insolvency at the time of receiving the checks. If so, under well-established principles, the receiver cannot hold the proceeds.

The order will be for the petitioner on the Bortz petition, and for a reference on the Attie Bros. petition. The matter of the rent deposit was disposed of on the argument.

243 Fed. Rep. 633.



Acceptance

U. S. COURT

*Powers of Cashier—Representation by
Officers—Issuance of Draft
Acceptance*

Circuit Court of Appeals, Eighth District,
March 19, 1917.

CITIZENS TRUST CO. VS. ABSTON WYNNE & CO.

The Missouri Negotiable Instruments Law (Rev. St. Mo. 1909, section 10102 et seq.) provides that an acceptance must be in writing and signed by the drawee, that the drawee is allowed twenty-four hours after presentation in which to decide whether or not he will accept the bill, but that where he "destroys the same, or refuses within twenty-four hours after delivery, or within such other period as the holder may allow, to return the bill accepted or nonaccepted to the holder, he will be deemed to have accepted the same."

The president and manager of a mercantile corporation, who was also cashier of the bank in which it was a depositor, made

a time draft on the bank in its behalf in favor of a holder of the corporation's note, requesting that it be sent direct to the bank for acceptance. This was done, with a request that it be accepted and returned at once. A few days later the payee again wrote, asking to be informed by return mail whether the draft would be returned. It was not returned, but the bank, by the cashier, sent its own draft on a correspondent bank for the amount, which was received by the payee, and the note, which was signed by solvent sureties, was surrendered. Some two and one-half years afterwards a receiver for the bank brought suit to recover the money paid on its draft. *Held*, that the action of the bank amounted to an acceptance, which made it the principal debtor on the draft, and that it was bound by the payment.

Action at law by the Citizens' Trust Company, as receiver of the Pemiscot County Bank, against Abston, Wynne & Co. Judgment for defendants, and plaintiff brings error. Affirmed.

STATEMENT OF FACT AND OPINION

Per Curiam. Caruthersville is the county seat of Pemiscot county, the southeast county of Missouri. The Pemiscot County Bank was organized there, and at the times here material William A. Ward was its president and A. C. Tindle its cashier. Mr. Tindle was a stockholder, president, and general manager of the People's Gin Company and a stockholder in the Missouri Cotton Oil Company and the Tindle Cotton Company. He had a heavy interest in the Famous Store Company, which carried a stock of \$20,000 in a building of its own worth about \$5,000. He was president and a dominating and controlling officer of this company. He also owned a great quantity of land and town property. John H. Poston, Jr., an agent of the defendants, who went to Caruthersville to investigate him and others, reported in October, 1911, that he was worth upwards of \$40,000 after deducting all incumbrances, exclusive of his interest in the Pemiscot County Bank and the Famous Store.

The defendants were a firm of wholesalers and cotton factors at Memphis, Tenn. In the fall of 1910, Mr. Tindle, acting for the People's Gin Company

and the Missouri Cotton Oil Company, made an arrangement with the defendant to advance \$7,500 to each of said companies to assist in carrying on their business. Each of the companies gave its note for the amount of advances to it, signed by the company and Mrs. Sallie M. Roberts, Mr. W. H. Johnson, Mr. W. A. Ward, who was president of the Pemiscot County Bank, and Mr. A. C. Tindle, heretofore fully referred to. This money was drawn by drafts on the defendants. These two companies would send products of theirs to the defendant firm for sale and credit. After any consignment had been sold, the net proceeds would be credited to the proper company, and when the notes given matured they were charged to the proper company in its general account.

In 1911 the same system was followed on a more extensive scale. In September, 1912, the defendants loaned the Tindle Cotton Company \$20,000 in a similar manner but no additional loans were made this year to the People's Gin Company or to the Missouri Cotton Oil Company. On January 25, 1912, Mr. Tindle was at Memphis, and then on behalf of the People's Gin Company and the Missouri Cotton Oil Company settled their accounts with Abston, Wynne & Co., and gave in the names of the respective companies, two in the name of the People's Gin Company and two in the name of the Missouri Cotton Oil Company, drafts upon the Pemiscot County Bank.

These drafts were one drawn by the People's Gin Company for \$5,007.62, to be paid February 1, 1912, one drawn by the Missouri Cotton Oil Company for \$5,021.91, to be paid February 15, 1912, one drawn by the People's Gin Company for \$3,497.61, to be paid March 1, 1912, and one drawn by the Missouri Cotton Oil Company for \$2,868.86, to be paid March 15, 1912. That these drafts were all drawn for bona fide indebtedness of the companies drawing them is without dispute. Mr. Tindle did not offer to accept these drafts as cashier of the Pemiscot County Bank, but suggested that they be sent direct to that bank for acceptance.

While it may be negligence to send a draft direct to the drawee for acceptance, there is nothing to indicate that by such negligence the payee will be prejudiced in a suit with the drawee. Abston, Wynne & Co. sent these drafts in a letter, January 25, 1912, in which they said:

"Please accept and return these drafts to us at once."

This letter in all probability reached Caruthersville not later than January 26 or 27, 1912. Who got the letter from the postoffice is not clear. Under date of February 3, 1912, the Pemiscot County Bank, by A. C. Tindle, its cashier, sent to Abston, Wynne & Co. its draft on the National Bank of Commerce of St. Louis for \$5,007.62 in payment of the first draft of the People's Gin Company. On February 5th, Abston, Wynne & Co. wrote as if they had not received this remittance to the Pemiscot County Bank referring to these drafts, saying:

"We now ask that you please let us know by return mail whether these drafts will be returned or not."

Apparently later the same day Abston, Wynne & Co. acknowledged to Mr. Tindle the receipt of the draft of \$5,007.62 in payment of the People's Gin Company debt and added:

"We cannot understand why the bank does not return us the three other drafts, and wish you would please let us know at once whether or not they are going to do so."

On February 10, 1912, the Pemiscot County Bank, by William A. Ward, its president, sent back the second People's Gin Company draft and the second Missouri Cotton Oil Company draft accepted, and stated they would remit promptly for the first Missouri Cotton Oil Company draft, which was then due in five days, and this they did on February 24, 1912. On July 21, 1914, the Missouri circuit court of Pemiscot county appointed the Citizens' Trust Company as receiver of the Pemiscot County Bank, and on July 29, 1914, it brought this suit, by filing a petition in the state circuit court for Pemiscot

county, Mo., seeking to recover the amount paid on the first People's Gin Company draft. The case was removed to the United States District Court for the Eastern District of Missouri, where the parties filed a stipulation waiving a jury, and the case was tried, and the court dismissed the case at plaintiff's cost, and it sued out a writ of error to this court.

It is contended that Ward, the president of the now defunct bank, had signed the People's Gin Company notes for which this draft was given in payment, and that Tindle, the cashier of the bank, had not only signed the notes, but was the president and general manager of the People's Gin Company. There is no room to claim, however, that Ward and Tindle were anything but sureties upon these notes as between them and the People's Gin Company.

It is first insisted that the draft issued on the St. Louis Bank of Commerce was never paid for, and was issued by Tindle in payment of his own debt. Among the powers ordinarily inherent in the position of cashier is that of issuing drafts drawn on his bank's funds on deposit with a correspondent bank. Morse on Banks and Banking (4th Ed.) section 154; Zane on Banks and Banking, section 100.

It will be conceded for the purpose of this case that there is this exception to that rule: That the cashier had no implied authority to issue such drafts in payment of his own debts, and when he issues such a draft to an individual creditor in payment of his individual debt, such creditor, knowing the law, is charged with notice of the apparent lack of authority of the cashier to draw the draft, and in the absence of a showing that the cashier had been expressly authorized to draw the draft or the like for his own debt it would be liable to the bank in an action such as this for money had and received. The question then arises, if he issue a draft, not for the debt of the cashier, but for the debt of a corporation in which he is a stockholder and managing officer, and upon which debt he is surety, does the same rule apply, and does he have no

implied authority to draw a draft in payment on the bank's funds? This identical question was before the Supreme Court of Tennessee in a case between these same parties. *Pemiscot County Bank et al. vs. Central State Bank et al.*, 132 Tenn. 152. In that case the court said:

"In this state of the law, and in this attitude of the court in respect to the doctrine above stated, we are asked to take a step further in advance, and to hold that, where the cashier of a bank issues a draft of his bank on its correspondent, over his signature as cashier, to the collecting bank or agency of a creditor of a mercantile corporation in honoring that corporation's draft or check on the bank, or for a note payable there, the same rule as to imputed notice of embezzlement shall apply. The matter may be presented in sharper outline if, purely for the purpose of test, the case be conceded to be that the draft was drawn directly in favor of *Abston, Wynne & Co.*, as payees, as a way of the *Pemiscot County Bank's* paying the draft on it issued to the *Memphis firm* by the *Famous Store Company*. May the doctrine be fairly or justly extended, so as to hold the *Memphis firm* to have been put on inquiry as to the cashier's authority by what would thus appear on the fact of the bank's draft? In our opinion it cannot, and we are entirely satisfied in declining to so hold.

"The *Famous Store Company* was an entity distinct from *Tindle*; it was accepted and dealt with as a customer by the bank as such entity. To the extent that *Tindle*, as president of the *Store Company*, controlled its affairs, it would have cast at least a shade of suspicion on the bank in the community, had that company failed or refused to do business with the bank of which *Tindle* was cashier. It would be an undue stretch to hold that the drawing of a draft on a correspondent city bank by *Tindle* as cashier in favor of the *Store Company* or its creditor imparted notice to the creditor on reception that *Tindle* was unfaithful in his trust as cashier. *Abston, Wynne & Co.* were

not his individual creditors. We must assume, even if *Tindle* dominated the *Store Company*, that there were directors and agencies in that company who were true to their trusts, and would refuse to join *Tindle* in looting the bank in its behalf, and who would, at least in the view of the trading public, operate to deter *Tindle* from such speculation for that company's benefit. The counsel of the appellee cite no authority which supports such an advanced position; they concede that after diligent search they have been unable to find any.

"It is apparent that appellees must maintain the position that *Tindle*, as cashier, and therefore as chief executive officer, of the bank, was without power or authority to act in accordance with the usage, practice, and course of business of banking institutions in drawing drafts in favor of corporations in which he was also an officer. Touching the principle bearing upon that point, it was said in *Mining Co. vs. Bank*, 10 Colo. App. 339, 347, 50 Pac. 1055, 1058, as follows: 'It is contended that the note appeared upon its face to be executed by a corporation, and to a corporation of both of which the same person was president, and that this was sufficient notice to put *J. B. Wheeler & Co.* and each subsequent transferee upon inquiry as to all matters affecting its validity. * * * In any event, the argument depends for its force upon the theory that where a note is executed by one corporation to another, and the same person is president, of both, it is prima facie void. These premises are not correct, and the argument therefore falls to the ground. However much such a circumstance may render it obligatory upon a court to scrutinize closely the bona fides of a transaction in certain cases, it by no means follows that it creates a presumption as to the invalidity of the paper, either as to want of authority to execute it, or of consideration. * * * The note did not disclose any suggestion that the maker was without authority to make it, or that it was for the benefit of any one of the officers

making it.' See also *Cheever vs. Pittsburg, etc., R. Co.*, 150 N. Y. 59, (cited and quoted with approval in *Bank vs. Butler*, 113 Tenn. 574), and *Orr vs. South Amboy, etc., Co.*, 113 App. Div. 103.

"To enlarge the above exception to the general rule as to the power of a cashier to issue bank drafts, so as to include in that exception drafts or cashier's checks drawn in favor of such corporations or its creditors, would be to seriously hamper commercial transactions. The settlements made with such paper as exchange vastly exceed in number and amount those made with currency. Sound policy dictates that no further burden be placed by the courts on such paper to the embarrassment of commerce. The free flow and the amplest acceptance by the trading public of such paper should be facilitated by the law not further embarrassed or hindered. Judge Peckham well said that bank or cashier's drafts are used so enormously at the present time in payment of debts and in settlements that they have almost acquired the characteristics of money, and are regarded by the commercial community as so much cash. True, money bears no 'earmarks' that may give rise to suspicions on the part of the recipient as to the manner in which it was obtained by one who pays it (*Thompson vs. Clydesdale Bank*, [1898] 3 A. C. 202, 69 L. T. N. S. 156; *Ball vs. Shepard*, 202 N. Y. 247; *Goshen Nat. Bank vs. State* [141 N. Y. 379], *supra*), while bank drafts may, as we have observed, still the better policy does not look towards the courts adding to such drafts other marks of dissimilarity to currency. It is more reasonable and just to place upon the directors of a bank the hazard of guarding their institutions from embezzlement by the cashier, who is chosen, and may be caused to be adequately bonded, by them, than to shift the perils incident to his wrongdoing against the institution to the public which is without voice in that regard. Such dishonesty is, fortunately, a thing sporadic, and its results, practically speaking, are confined

to a limited territory and to comparatively few persons; whereas, further restrictive rules would affect the currency of such commercial paper, measureless in volume, every business day of the year.

"As was said in *Cheever vs. Pittsburg, etc., R. Co.*, *supra*, in reply to a suggestion that a similar ruling would open an easy way for the perpetration of frauds: 'It is more reasonable and just to assume that corporations will be able to protect themselves by proper vigilance from the dishonesty of their own officers than to impute to parties who have taken the paper for value, ignorant of its origin, constructive knowledge of the facts upon such circumstances as exist in this case.' If the results of delinquency or lack of diligence on the part of the management or supervising agencies of a bank are to be shifted to and borne by the public, then from the standpoint of economics this should be done by way of an undisguised tax levied on the holdings of the public, rather than by way of further depreciating and clouding a medium of exchange so widely in use."

In these days of interlocking officers and directors, now happily passing away, we should be inclined to follow that case, except for a doubt as to whether in effect the case has not been otherwise decided recently. *German Savings Bank vs. Des Moines National Bank*, 122 Iowa 737; *Ft. Dearborn National Bank vs. Seymour*, 71 Minn. 81.

There is another ground upon which it is somewhat more clear to us that plaintiff cannot recover. In 1905 the state of Missouri adopted a negotiable instruments act. This provided (section 10102, Revised Statutes of Missouri 1909):

"The acceptance must be in writing and signed by the drawee."

Section 10106 provides that:

"The drawee is allowed twenty-four hours after presentment in which to decide whether or not he will accept the bill."

Section 10107 provides that:

"Where a drawee to whom a bill is

delivered for acceptance destroys the same, or refuse within twenty-four hours after delivery, or within such other period as the holder may allow, to return the bill accepted or non-accepted to the holder, he will be deemed to have accepted the same."

In Ruling Case Law, vol. 3, p. 1303, it is said:

"It is not to be supposed that, under the Negotiable Instruments Law, a bill can only be accepted by writing signed by the drawee. It is true that verbal and implied acceptances have been abolished by the section which provides that the acceptance must be in writing and signed by the drawee. But the statute also declares that the action of a drawee in destroying a bill or in not returning it, as required by the section, shall be deemed an acceptance of it."

And in 8 Corpus Juris, 303, it is said:

"The Negotiable Instruments Law expressly provides that 'the acceptance must be in writing and signed by the drawee,' and it is held thereunder that an oral acceptance is not binding on the drawee. This provision applies equally well to checks, but does not affect constructive acceptances by delay in returning a bill."

It was held in *Wisner vs. First National Bank of Gallitzin*, 220 Pa. 21, 68 Atl. 955, that the mere retention of a bill or check for more than 24 hours constituted an acceptance under a statute very similar to the Revised Statutes of Missouri, section 10107.

* * *

When the drafts were sent to the Pemiscot County Bank by mail by Abston, Wynne & Co., they did not content themselves with simply sending the drafts, but wrote, "Please accept and return these drafts to us at once." While the bank had remitted for the first People's Gin Company draft under date of Saturday, February 3, 1912, on Monday, February 5, 1912, apparently not having heard from the Pemiscot County Bank, Abston, Wynne & Co. wrote, "We now ask that you please

let us know by return mail whether these drafts will be returned or not." Not only did the Pemiscot County Bank remit the amount of the People's Gin Company draft under date of February 3, but sent in formal written acceptances of the second draft of both the People's Gin Company and the Missouri Cotton Oil Company, but agreed in writing to accept the first Missouri Cotton Oil Company draft and to pay it when due. The Pemiscot County Bank has never returned or offered to return the draft of the People's Gin Company on it to Abston, Wynne & Co., although repeated demands have been made upon them to do so. These circumstances all show that it accepted the draft within the meaning of the Missouri statute. So far is this true that it is practically conceded by plaintiff in error who say in their brief:

"In January, 1912, the defendants were insisting on payment of the notes which they held made by the People's Gin Co., and indorsed by Wm. A. Ward, A. C. Tindle, Sallie M. Roberts, and W. H. Johnson, and Tindle went to Memphis, and in settlement of the amount due on the note of the People's Gin Co., as aforesaid, made to them time acceptances on the Pemiscot County Bank, signed by the People's Gin Company, by A. C. Tindle, president, and requested the defendants to send the acceptances direct to the Pemiscot County Bank for acceptance, which was accordingly done, and Wm. A. Ward, as president of the Pemiscot County Bank, accepted the time draft so drawn on the Pemiscot County Bank in payment of the notes made by the People's Gin Co."

The case is therefore argued upon the theory that the draft in question was drawn in payment of a draft accepted by the Pemiscot County Bank. Assuming this to be true, the instant the bank accepted this bill drawn on it by the People's Gin Company, it became the principal debtor thereon. *Wallace vs. McConnell*, 13 Pet. 136; *Superior City vs. Ripley*, 138 U. S. 93. And the issuance of a draft on its St.

Louis correspondent by its cashier was in payment of its own debt, and not the debt of any other person, and was clearly within the powers of the cashier.

It is perhaps proper here to say that the counsel for the plaintiff below said:

"It is admitted here by the plaintiff that the proof in the case does not show any fraud, any actual fraud, on the part of these defendants, in that the proof does not show that they had any notice of Tindle's defalcation, if there were any, with the Pemiscot County Bank."

The long delay in assailing the transactions of nearly two and one-half years, and the fact that the bank kept the draft and has never offered to return it to this day, and that, in reliance on the conduct of the bank, Abston, Wynne & Co. surrendered the notes they held for the amount, signed by Mrs. Sallie M. Roberts, who was amply good and had more wealth than all the other signers, and their settlement with her as to the balance on which she was surety, might establish the defense of laches or of an estoppel outside of laches; but the sole answer in this case is a general denial, and these defenses cannot be considered.

Upon the grounds already indicated, the judgment of the District Court was correct, and it is affirmed.

(242 Fed. Rep. 393.)



Fraud

NEW YORK

Bona Fide Purchaser—Notice—Stolen Instrument

Supreme Court, Special Term, Bronx Co., July 10, 1917.

MONK VS. TWENTY-THIRD WARD BANK ET AL.

Where fraud is shown in the manner in which a negotiable instrument is procured to be delivered to the original holder, subsequent holders have the burden of proving want of actual or constructive knowledge

thereof and that they are purchasers for value.

A purchaser of stolen checks, even in good faith, for value, and without notice of defect in the title of the vendor, could not obtain a good title as against the true owner.

Action by John Monk against the Twenty-Third Ward Bank and others, to determine title to proceeds of a check and to declare a trust therein in favor of plaintiff. Judgment for plaintiff.

STATEMENT OF FACT AND OPINION

Giegerich, J. The action is brought to determine the ownership of the proceeds of a check for \$1,950, made by the plaintiff to the order of the defendant Whitlock and indorsed and delivered by him to the defendant Bryant, who indorsed and deposited it for collection in the defendant, the Twenty-Third Ward Bank. The plaintiff seeks to recover the proceeds of the check on the theory that equity should declare a trust in said proceeds in his favor. The check was drawn on the First National Bank of San Francisco and was certified. Upon the face of the check there was written in ink the words, "Submitted with bid on Haiti-San Domingo Bldg." On the back of the check there are indorsed the names of Richard B. Whitlock, David McKown, and J. Wilson Bryant, in addition to the stamps of the two banks, the Twenty-Third Ward Bank and the American Exchange National Bank, through which the check passed before it was ultimately paid by the San Francisco bank upon which it was drawn. Upon the back of the check there is the impression of a seal superimposed on the indorsement of Richard B. Whitlock, bearing upon the outer of the concentric circles of the seal the words "Republic of Haiti, Richard B. Whitlock," and in the inner circle the words "Commercial Agent." The case, that it was filed in the District Court of the Southern District of New York, on January 1, 1917, and that the plaintiff cured the check in the money with considerable number of checks to Kuehl or any to contractors in connection and surrender to the bank, stating that

he represented contemplated the erection of a building at the Panama-Pacific Exposition, and the checks sent on represented ten per cent. of the bids of the respective contractors for erecting the building required. As a matter of fact, Whitlock had no authority to represent those governments, and the checks were fraudulently procured.

The defendant McKown claims to have advanced to Whitlock in various payments the sum of \$1,375 on the faith of the check which Whitlock had previously indorsed and delivered to him. The plaintiff's counsel urges that the words on the face of the check, together with the seal impressed upon the back thereof, taken in connection with the fact that the check was made payable to Whitlock's order personally, and the further fact that the defendant McKown knew that Whitlock was using the check for his personal purposes, taken together, constitute such notice to McKown that it cannot be said that he advanced money on the check in good faith. There is no serious question between the parties as to the law applicable to the case.

Both sides recognize that it is well established that, where fraud is shown in the manner in which a negotiable instrument is procured to be delivered to the original holder, subsequent holders have the burden of proving that they are free from actual or constructive knowledge of the fraud, and that they are purchasers for value. The plaintiff cites in support of this principle *First National Bank vs. Green*, 43 N. Y. 298; *Vosburgh vs. Diefendorf*, 119 N. Y. 357; *Canajoharie Bank vs. Diefendorf*, 123 N. Y. 191; *American-Exchange National Bank vs. New York Belting Company*, 143 N. Y. 698; *Wartthems, Uniform Company vs. Garifalos*, drafts, but w. 675; *Negotiable Instruments* (6th Ed.) section 98; *Daniel on Negotiable Instruments* (6th Ed.) section 98; *Anchor Company vs. First People's Gas Company*, 161 N. Y. 161, date of Saturday, February 5, 1904, Monday, February 5, 1904, not having heard from the holder of a County Bank, Abston, who has no ac-

tual knowledge or notice of a defect in the title, or other equities between the parties, when circumstances come to his knowledge sufficient to put him upon inquiry, is chargeable with knowledge of all the facts that such inquiry would have revealed. *Gerard vs. McCormick*, 130 N. Y. 261; *Cheever vs. Pittsburgh, S. & L. E. R. Co.*, 150 N. Y. 59; *Rochester & C. T. R. Co. vs. Paviour*, 164 N. Y. 281; *Citizens' Bank vs. Rung Furniture Co.*, 76 App. Div. 471; *Cohnfeld vs. Tanenbaum*, 176 N. Y. 126, 68 N. E. 141; *Ward vs. City Trust Co.*, 192 N. Y. 61; *Empire State Surety Co. vs. Nelson*, 141 App. Div. 850; *Royal Bank of N. Y. vs. German-Am. Ins. Co.*, 58 Misc. Rep. 563.

In this case, the facts were such as to put the defendant McKown upon inquiry, and, if he had made inquiry, he would have obtained such information that he would not have paid any money to Whitlock. He is the one, therefore, who should bear the loss. In connection with the question whether the facts were such as to put McKown upon inquiry, special mention ought to be made of the improbability of the explanation given by Whitlock to McKown as to how he came to possess the check. That explanation was that he and Monk had been in copartnership, and that upon dissolution of that copartnership Monk had turned over to him this check as his share of the profits. McKown could explain, however, why it was, if this check was made out to Whitlock by Monk to pay a share of the firm profits, that it bore the words, "Submitted with bid on Haiti-San Domingo Bldg.," or, on the other hand, why it was, if the check had been sent as a deposit on a bid by the firm or by Monk to erect that building, that it was made payable to Whitlock, instead of to some one representing these governments.

The same result in favor of the plaintiff follows if this case is rested on the authority of *Bryant vs. Century Bank*, 155 N. Y. Supp. 1010. That case involved checks obtained by Whitlock in the same manner as in the present action. The court held that Whitlock's means of obtaining the checks consti-

tuted common-law larceny, and that a purchaser of such checks, even in good faith and for value, and without notice of defect in the title of the vendor, could not obtain a good title as against the true owner.

My conclusion is that there should be judgment for the plaintiff as indicated in the plaintiff's requested conclusions of law, all of which have been found by me. The requests for findings of the respective parties have been passed upon as indicated on the margins thereof. Submit for my signature, upon two days' notice of presentation, a decision embodying without change of language all findings made by me, with proof of service.

(165 N. Y. Supp. 1057.)



Special Deposit

WISCONSIN

Conversion of Funds—Liability

Supreme Court, Wisconsin, June 12, 1917.

ZIEGENHAGEN VS. SURING STATE BANK.

If a bank receives a deposit for an express purpose, but uses it for a different purpose, it is liable to the depositor therefor.

Evidence held to show that a deposit was a special deposit, so that application thereof to another purpose rendered the bank liable to the depositor.

A memorandum when a loan was made by a bank in the disposition of it, unsigned and mailed or handed to the depositor, does not constitute a contract.

Action to recover for an alleged conversion of \$280.00 and interest. The claim of the plaintiff was that he placed \$280.00 with the defendant with instructions to use it in paying his note of \$275.00, held by the Cecil State Bank which was given by plaintiff to one Kuehl, and endorsed by him to said bank, and that, instead of doing so, it paid the money to Kuehl. The question litigated was whether plaintiff directed the money to be paid to the Cecil State Bank, as he claimed. There was a conflict in the evidence in respect thereto.

In answer to a special question involving such matter the jury found in favor of plaintiff and judgment was rendered accordingly.

STATEMENT OF FACT AND OPINION

Marshall, J. The several assignments of error, so far as they seem debatable on the record, come down to the one question of whether the verdict is warranted by the evidence.

The evidence of respondent, standing alone, that he deposited the money with the appellant for the special purpose of paying his note held by the Cecil State Bank, is quite as credible as that of the cashier of appellant who transacted the business in its behalf, that the money was deposited for the benefit of August Kuehl, who withdrew it. The answer admits that appellant received the money for an express purpose, therefore if it used the same for a different purpose, obviously it is liable therefor.

The circumstances of the transaction in question quite persuasively corroborate the evidence of respondent. He owed Kuehl \$200 on book account. He borrowed one thousand dollars of appellant. Part was used to pay the amount owing thereto by respondent on several notes, \$200 was withdrawn to pay Kuehl on the book account, \$280 was left with appellant for the controverted special purpose and the balance was deposited to be drawn by check. If respondent intended the \$280 for Kuehl, it seems probable that he would have withdrawn it as he did the \$200, and paid it to him. It is hardly reasonable that he directed the money to be paid Kuehl when it was intended to be used to take up the note and that had been sold by him to the Cecil bank. The most natural thing was to leave the money to be used in payment to such bank of the note, if respondent had been informed, as the jury might well have found was the case, that it held the note. Certainly, it is hardly believable that he left the money with appellant to be paid to Kuehl or any one without production and surrender of the note.

When the one thousand dollar loan was made, appellant's cashier made a memorandum of the disposition of it, containing the words and figures "August Kuehl's order \$280.00." That was either handed to plaintiff or sent to him by mail. It was unsigned and obviously did not constitute a contract. Taken in connection with the cashier's testimony, it indicates that the \$280.00 was to be used to pay the note, not to be unqualifiedly paid to Kuehl. The note was, in effect, an order by Kuehl to pay the money to the holder thereof which was the Cecil State Bank.

The jury might well have found under all the circumstances that the memorandum was designed to be of the fact that August Kuehl's note was to be taken up with the money. There was considerable evidence, circumstantial and direct, to support that view. We will not prolong this opinion to refer thereto in detail. There is ample in the record to sustain the verdict.

The judgment is affirmed.

(163 N. W. Rep. 184.)

Replies to Law and Banking Questions

Questions in Banking Law—submitted by subscribers—which may be of sufficient general interest to warrant publication will be answered in this department.

Lost Pass Book

SAN FRANCISCO, Sept. 28, 1917.

EDITOR BANKERS MAGAZINE:

SIR—It is a common practice among many savings banks in California to require a depositor who has lost his savings pass book to give a bond of twice the amount of balance in said lost pass book before they will issue the depositor another pass book.

The bond of course secures the bank against any claim that might arise out of the loss of the original book. As a

hypothetical case we will say that the depositor did not lose the book but assigned it for value received to an innocent party. Before the assignee reached the bank the original owner secured a new book, and immediately thereafter withdrew the account—would the assignee have any claim against the bank? If not, can you see any reason why savings banks should continue to take indemnity bonds?

A. C. B.,
Assistant Cashier.

Answer: The assignee of a savings bank pass book would have the same rights as the owner, subject, of course, to the rights of the bank issuing the same, one of which is knowledge of the ownership of the book, and until notice of change of ownership is properly brought to its attention, it could not be held liable for payments made in accordance with its contract. This contract calls for the presentation of the book upon making withdrawals, and in cases of lost book, the book cannot be presented, and to avoid such cases as you mention, the bond of indemnity is taken.

A savings bank pass book is not negotiable and does not pass by the ordinary process of indorsement and delivery. It may be transferred by proper assignment, and convey good title, and in order to safeguard themselves, some banks provide in the by-laws that assignments to be binding upon the bank must be made at the banking house, or as others put it, no obligation will be incurred until notice is properly received.

The bond of indemnity is taken in a great many banks in cases where books are lost to guard against assignments made in fraud, under conditions such as you mention. The writer is familiar with the savings bank cases of New York for the past thirty years and no case is on record where the book has been assigned and payment made to the original owner. Nor has a case arisen in any court of record during the past five years involving this point. If it had, it would have been reported in the

Law Department of THE BANKERS MAGAZINE.

The assignee could have no claim upon the bank until notice was received, under the principle that gives the stockholder no claim against the corporation until the transfer of stock is duly recorded. The bond of indemnity is going out of use in many banks, inasmuch as it works hardship upon the depositor

and advertisement and affidavit proves sufficient in most cases. There may be instances where the bond would be justified, as where the book was known to be in possession of another claiming title thereto.

Answering your inquiry, in short: The assignee has claim only against his assignor until notice is properly given to the bank.

How Bankers Are Doing Their Bit

AS in the case of the big banks in the Entente countries, every one of the metropolitan banks in this country has a long list of men who have entered into active war service, some as commissioned officers in army and navy and some as privates who have responded cheerfully when called to the selective army. The bank house organs each carry a long list of men who have freely offered themselves to their country and when the history of the war is written the part the bankers played will make an impressive chapter.

DOING RED CROSS WORK

The United States Official Bulletin prints the following list of bankers who are now in charge of important Red Cross activities and who are serving without compensation:

Charles D. Norton, of New York, first vice-president of the First National Bank of New York; member of the Red Cross War Council.

Maj. Grayson M-P. Murphy, of New York, vice-president of the Guaranty Trust Co. of New York; Red Cross commissioner to Europe and member of the Red Cross War Council.

Martin Egan, of New York, member of the staff of J. P. Morgan & Co., of New York; assistant to H. P. Davison.

Stephen C. Millett, of New York, of the banking firm of Millett, Roe & Hagen; in

charge of the cable department for the war council of the Red Cross.

John W. Prentiss, of New York, partner in the firm of Hornblower & Weeks; financial assistant to the war council.

Harvey D. Gibson, of New York, president of the Liberty National Bank; general manager of the Red Cross.

James Jackson, vice-president of the State Street Trust Co., of Boston; division manager of the New England division.

Ralph Hornblower, of Boston, member of the firm of Hornblower & Weeks; cashier of the Red Cross war fund.

Frederick J. Fuller, vice-president of the Central Trust Co. of New York; representing the assistant treasurer of the Red Cross war fund.

Bruce D. Smith, vice-president of the Northern Trust Co., of Chicago; division manager of the central division.

William Lawrence Peel, formerly president of the American National Bank of Atlanta, Ga.; division manager of the southern division.

SERVICE FLAGS IN WALL STREET

Practically all of the banks and trust companies in the financial district are displaying service flags, says the New York "Times," and visitors from out of town are now treated to a new form of diversion, namely of counting the number of stars. Some of the flags are exhibited on upper floors, and some of them are so closely covered with stars that it is difficult to make an accurate count. Many of the corporations are



Boston in War Time—The Old Colony Trust Company and Its Service Flag

likewise recognizing the enlistment of their employees in the army and navy by service flags, and one of them, the New York Telephone Co., found it impossible to set 1009 stars in a flag measuring 24 by 40 feet, and consequently it has resorted to the expedient of using numerals. Besides the display of flags, a great many organizations have posted rolls of honor containing the names of the men who have joined the army or navy.

"BOUND TO DO OUR BIT"

Merchants & Planters Trust and Savings Bank, Warren, Ark.; Carl Hollis, cashier: "Writer is treasurer of the Red Cross War Fund and chairman of the local Red Cross Society. He is giving just about all his time to these and kindred matters—all because we feel that we are bound to do our bit."

Farmers State Bank, Rogers, Ark.; Perry N. Clark, cashier, after stating the various war activities of his bank, concludes: "I assure you that it affords us pleasure to do everything in our power that may in any way be helpful

to our own country and to our allies."

First National Bank, Alturas, Cal.; B. F. Lynip, cashier, writes: "The officers, directors, shareholders and employees realize that this is not the time for idle discussion, but the time for action and for deeds to be performed, and for every citizen, no matter what conditions surround them, each to do his duty, and if that is done they feel that this war will soon terminate. We are determined to do everything in our power consistent with reason and judgment for an early termination of the war."

Bald Knob (Ark.) State Bank; E. E. Best, assistant cashier, writes: "The 'bit' our bank is doing, by way of helping and coöperating with our Government in this 'Our Last Stand for Democracy' seems to be so insignificant that it is hardly worth mentioning, however, the writer and our cashier are numbered with the 'Four Minute Men' making four minute talks on subjects authorized by the Government, at our local moving picture show and other public gatherings. Our bank is coöp-

erating and assisting in every way possible the farmer, in diversifying his products, especially in planting wheat. Our cashier is secretary of the Bald Knob Fruit Growers' Association, which position brings him in very close touch with the farmer and his needs. This association represents about two hundred farmers, and the past spring marketed about \$150,000 worth of strawberries."

Many other banks all over the country write of officials and employees who have gone into service, freely offering themselves in the fight for Democracy. Bankers everywhere have led the world in patriotic service, in raising special war funds, marketing the War Loans, and above all, at the front, in the thick of the fighting, as the roll of honor of many an English, French and Colonial Bank will testify.

Making the Dollar Work*

By JOHN M. FRENCH

"**Y**OU ask me how I made my money?" said a millionaire, addressing a youthful son of an old but impoverished friend, who had come to him with a letter of introduction.

"I didn't make my money. It was my money that made me. When I left the village where your father and I used to play 'hokey' together, all the capital I had was a stock of good health and a serviceable suit of store clothes, nothing more.

"It isn't hard to make money if you begin in the right way. It is the beginning that counts every time.

"Some people imagine that to become rich, a man must slave himself to death. Nothing of the kind. Lots of the fellows I used to know did as much hard work in one day as I did in a week, and when they died, their widows had to take in boarders.

"No matter how hard a man may work, he can never make more than a fair day's pay if he has to do all the

work himself. To become wealthy, he must employ others to work for him, and so make a profit on their labor.

"I discovered this when cleaning out waste-baskets and running errands at \$5.00 per week, and I made up my mind to get a lot of employees to work for me. It was pretty slow at first, but I kept plugging away until now I have more than a million."

"A million men!" exclaimed the boy.

"I didn't say men; I said employees," returned the millionaire. "My employees are *dollars*. Every one of them works for me twenty-four hours a day without wages, and I haven't had a strike called on me yet.

"The first thousand comes in very slowly. But dollars like to work where they have a lot of shop-mates, and the more you can persuade to come to your shop, the easier it is to induce others. After a while they just rush to you for employment.

"When I earned \$5.00 a week, I used to drop a quarter every Saturday night in a little iron bank furnished by a Trust Company, and every month the

collector called to get the dollar and put it to work for me.

"By and by, when I was earning \$10 a week, I dropped four quarters in the bank, so that four new dollars were each month sent to join the others.

"There came a time when my wages were raised to \$100 a month, and I put aside the little iron bank and opened a savings account with the Trust Company. Then regularly, every four weeks I sent a new squad of \$15 to help the others.

"Time went on and the Trust Company kept my dollars steadily at work earning money until, at the end of seven years from the day I dropped my first quarter in the little iron bank, I had *one thousand* 'dollar' employees on the job.

"The Trust Company to whom I loaned my dollars used in turn to rent them out to other people, and was getting more for their services than I was,

so I concluded that I had better buy stock in the company. Immediately my dollars began to earn twice as much as they did before.

"Then I discovered that I could hire dollars from the company and put them out to work on other jobs. On this outside work they earned three and four times as much as I had to pay the Trust Company for them.

"After a time I owned and controlled so many dollars that they made me a director of the Trust Company, and it became part of my business to rent dollars to work for other people.

"At last so many came back to me that I now have a million in my employ, and don't have to work myself at all if I don't choose to.

"You see, my boy, it's all very simple. You've only got to begin right and keep as many dollars busy as you can persuade to work for you."

Items For Which Vouchers Are Missing

YES, IT WAS HONORED UP THERE

IT seems that it is customary with certain religious sects in this country to place a stipulated amount of money in the coffin of the deceased in order to tide the departed "over the river." Therefore the story is told of a family in New York who, at the close of the funeral services, were about to place one hundred dollars in the casket. The five brothers of the deceased gathered in a circle and into the hands of the eldest each of the four placed a twenty dollar bill, crisp and new. For some moments the eldest stood looking at the new bills which prompted one of the brothers to remind him that now it was his turn to put in a bill. Whereupon

the eldest wrote out his check for one hundred dollars on his bank, pocketed the eighty, and it is said at the bank that as yet they have not been called upon to honor it.



A PECULIAR ADVERTISEMENT

BANKS in Southern Pennsylvania have for some time taken advantage of the large bill boards in the smaller towns and cities as a means of advertising. At the time the last Liberty Loan was being subscribed for a certain bank advertised it on its bill boards. As it happened one of the boards was backed up against a huge stone fence which surrounded a ceme-

tery and passers-by read the large type heading which had for its background the many tombstones in the cemetery: "Wake Up! Your Country Needs You."



HE FOLLOWED THE WILL

A MOST conscientious appearing individual, it is said, recently approached one of the officers of a downtown New York bank, stating that he had been appointed executor of the estate of one of their clients and it was his desire to withdraw the balance now deposited in the bank under the name of the deceased. He produced a copy of the will and together with a waiver handed it to the officer. After examining it carefully the officer said: "I am surprised to see that in this will such a large amount of money is set aside for a stone. I suppose that you have already erected this to his memory." Tears came into the executor's eyes, and pointing to an immense diamond shirt stud he exclaimed, "Yes, here it is."



HE KNEW WHAT HE WANTED

A CCORDING to one of his friends, a floorman at a Boston trust company relates that one day a rather shabby looking individual came to him and stated that he had the first check he had ever received in his pocket and he wanted to see the boss. For some time the floorman questioned the man, but he would not produce the check, and thinking that he might be a suspicious character, sent him away. In a little while he returned with the check in his hand and passing it to the floorman said: "I want to be certified."



SORRY, BUT WE CANNOT DO IT

SHORTLY after the announcement that hereafter one of the large banks in the city would pay interest on

checking accounts, the following letter signed by a woman came to the bank:

Gentlemen:

I was greatly rejoiced to read in the paper today that you pay interest on checking accounts. For the past three years I have kept a large checking account at your bank. During all of this time my account has always been about six hundred dollars and I feel that as a woman who must look out after her own interests I am entitled to receive interest for the past three years. This will amount to \$54 at three per cent. and being a woman I feel that I am entitled to three per cent. on a checking account. Please place that amount to my account if you do not wish to lose a good account. Otherwise I shall be forced to take my money to an uptown trust company, where one of my men friends keeps \$200 and gets four per cent and he can draw checks on it too.



HIS SUGGESTION

NOT long ago Jones accidentally ran into a friend who had just approached the vice-president of one of the largest banks in the city on the matter of a loan. "How did you make out?" Jones asked. "Well," his friend replied, "if I had my way about it hereafter they would spell vice-president v-i-s-e after the widely known article on a machinist's bench."



WE ALL WOULD DO IT

AN upstate bank located in a town of moderate size has for its advertising manager a most progressive personage. Recently he placed a large canvas sign in the window which read: "WE WILL PAY 25 CENTS for 1917 PENNIES." The first man to rush into the bank after reading the sign was the merchant across the way who accosted the advertising manager. "Now here is a 1917 penny," he said, "why do you make such a foolish offer when there are so many of them?" "Well," replied the advertising manager, "if you will bring us one thousand, nine hundred and seventeen pennies we will pay you twenty-five cents for them. Wouldn't you?"

Observations of a Country Banker



By W. LIVINGSTON LARNED

THERE was a convention of Bankers in our State about a month ago. We had a group picture taken. 'Looked it over some days afterward and I noticed that every face possessed one thing in common—optimism. There were fifty-two of us and we were all smiling—we all looked happy. The most thankless task on earth is handling other people's money. Nevertheless, wherever there is thrift, there is happiness. The two run in double harness, and a Banker's job in life is to hitch 'em up.

* * *

IHAVE a superstition about a paying teller's ability to READ the expression of people's faces, when they're drawing money. Somehow—at a glance, you can tell when they're doing it wisely or against their better judgment. For that one quick, breathless second a sort of something flashes across the features. There's no holding it back. Encouragement in that, to my way of reasoning. It shows that investment keeps a man's conscience alive.

* * *

AGODLY man of my acquaintance, beloved of the village, once told me that a great grief of his life was the poignant memory of having robbed his little savings-bank, as a child. He had never forgotten

it. When men grow up they rob themselves and their bank-account in a much more serious way—and think nothing of it.

* * *

AFARMER on the Larkin River Road asked some questions concerning the bank, and banking, of one of my cashiers. But he never opened an account and what was more—actually seemed to avoid me. I had known his father before him, and his attitude perplexed me. I cornered him on his own porch with the avowed intention of solving the puzzle.

"You make good money, don't you?" I asked.

"Not for five years," said he; "th' stock et it all up. I'm beginnin' to cash in on my investment."

"Have you a bank account?"

"No—," with hesitation.

"Intend to start one?"

"Hadn't intended to."

"Why?"

"Well—I—I was sort of ashamed. It takes a lot to START a bank account, doesn't it—an' you got to put in just so much every week or you'll be made fun of!"

The man was really ignorant of the ways and workings of the modern bank. A state of mind kept him from saving. He dreaded the embarrassment of not being able to live

up to a certain set of fantastic rules. I find there are many people—a great many—who do not know the first thing about banks. They have never taken the trouble to find out—to inquire—to investigate. Never having brushed elbows with an institution of this kind, all they know is what they hear. As a consequence, they entertain genuine awe for the subject in general. This pink-cheeked farmer acquaintance of mine had imagined that a certain sum **MUST** be brought in and banked **EVERY WEEK**. There was no such thing as “little two and three-dollar” deposits.

“I sort of felt that if I came in with some of those baby checks I get for milk and cream and butter, that you fellers would give me the laugh,” he went on to explain. “I can put away **SOME** every week, but not a whole lot—do you understand?” I took him around to the bank with me and I made him one of us. I introduced him to “the boys” and I left him for a half-hour in my room, where he could **SEE** and **HEAR**. I made him go in the vault and see the

workings of a safe-deposit locker. I gave him visual proof of the fact that some deposits amounted to the staggering sum of one silver dollar, and I put him in touch with the very simple “complications” of the banking business. When he came out, he was all grins. He had found we were just plain, ordinary human beings, and that the saving of a little money was not a problem in high finance, by any means. The week following, he brought three thousand dollars and deposited it. He trots around Saturday mornings with sums ranging from twelve dollars to two hundred. I often see him, from my office, as he badgers my boys and tells them the latest Ford jokes. All he needed was to “get acquainted”—nothing more. I never believed it could happen in this twentieth century—folks **NOT** knowing all about banks—but there is a liberal percentage it seems.

* * *

A BANK is Human—you mustn't forget **THAT** for a single second.



New Counterfeit \$5 Silver Certificate

SERIES of 1899, check letter “A,” face plate number appears to be 300, Houston B. Teehee, Register of the Treasury, John Burke, Treasurer of the United States (Indian head). This counterfeit is printed from photo-mechanical plates on a single sheet of paper of fair quality, with a few printed green lines representing the silk fiber of the genuine.

The note is a deceptive counterfeit,

but if carefully scrutinized it will be seen that the lathe work is broken and disconnected. The Indian portrait is too dark, the numbering is too large and poorly formed, as well as being out of alignment on the specimen at hand; the seal and large blue numeral, face of note, appears to have been hand cut, and the figures are poorly executed. The back of the note is more deceptive than the face. Care should be exercised in handling notes of this issue.

State Banks and Trust Companies Join Reserve System

FOLLOWING the recent amendments to the Federal Reserve Act removing most of the objections which the state banks had to becoming members of the Federal Reserve System, many leading banks and trust companies have joined the system. They have been impelled to this course by the liberalization of the law and by some concessions of the Federal Reserve Board, and especially by the appeal made to them by President Wilson, that on patriotic grounds it is desirable that there be at this time a closer union among the banks of the United States.

The accompanying list of state institutions now members of the Federal Reserve System is being added to daily.

STATE MEMBER BANKS

November 5, 1917

NAME AND LOCATION	CAPITAL	SURPLUS	TOTAL RESOURCES
BOSTON:			
American Trust Co., Boston, Mass.....	\$1,000,000	\$2,000,000	\$25,578,848
Commonwealth Trust Co., Boston, Mass..	1,000,000	500,000	24,001,520
International Trust Co., Boston, Mass....	1,500,000	1,500,000	23,933,840
Old Colony Trust Co., Boston, Mass.....	6,000,000	6,000,000	150,784,124
Fitchburg Bank & Trust Co., Fitchburg, Mass.	500,000	250,000	4,935,072
Newton Trust Co., Newton, Mass.....	400,000	400,000	4,889,053
Norwood Trust Co., Norwood, Mass.....	200,000	2,563,580
Winchester Trust Co., Winchester, Mass...	100,000	25,000	731,236
NEW YORK:			
Bank of Montclair, Montclair, N. J.....	100,000	80,000	2,799,827
Bankers Trust Co., New York City.....	11,250,000	11,250,000	327,011,784
Broadway Trust Co., New York City.....	1,500,000	750,000	34,726,703
Central Trust Co., New York City.....	5,000,000	15,000,000	209,953,374
Corn Exchange Bank, New York City....	3,500,000	6,991,165	153,989,100
Equitable Trust Co., New York City.....	6,000,000	10,500,000	230,210,148
Guaranty Trust Co., New York City.....	25,000,000	25,000,000	613,535,033
Metropolitan Trust Co., New York City....	2,000,000	4,000,000	63,853,782
New York Trust Co., New York City.....	3,000,000	10,000,000	90,773,776
Bank of America, New York City.....	1,500,000	6,000,000	60,903,035
Pacific Bank, New York City.....	500,000	500,000	19,907,579
Metropolitan Bank, New York City.....	2,000,000	1,000,000	28,801,800
Mercantile Trust & Dep. Co., N. Y. City...	1,000,000	500,000	8,593,786
Buffalo Trust Co., Buffalo.....	500,000	500,000	9,624,217
St. Lawrence Trust Co., Ogdensburg, N. Y.	100,000	25,000	893,362
Northern New York Trust Co., Watertown, N. Y.	400,000	400,000	7,151,603
Franklin Tr. Co., Brooklyn, N. Y.....	1,000,000	1,000,000	24,823,842
Brooklyn Tr. Co., Brooklyn, N. Y.....	1,500,000	2,898,481	40,270,629
Citizens Commercial Tr. Co., Buffalo.....	1,250,000	1,250,000	18,196,063
PHILADELPHIA:			
Girard Trust Co., Philadelphia, Pa.....	2,500,000	7,500,000	61,172,461
Miners Deposit Bank, Lykens, Pa.....	50,000	110,000	679,897

NAME AND LOCATION	CAPITAL	SURPLUS	TOTAL RESOURCES
CLEVELAND:			
Cleveland Trust Co., Cleveland, Ohio.....	2,500,000	2,500,000	55,121,784
Guardian Savings & Tr. Co., Cleveland....	2,000,000	2,000,000	52,731,355
Guardian Tr. & Savings Bank, Toledo, O..	200,000	200,000	4,224,961
Lawrence Sav. & Tr. Co., New Castle, Pa..	300,000	300,000	3,183,907
Citizens Tr. & Sav. Bk., Columbus, Ohio..	700,000	150,000	5,271,822
RICHMOND:			
Continental Trust Co., Washington, D. C.	1,000,000	100,000	4,289,237
Bank of Hartsville, Hartsville, S. C.....	50,000	50,000	394,626
Merchants & Farmers Bank, Cheraw, S. C.	100,000	3,000	338,007
Peoples Bank, Sumter, S. C.....	100,000	19,400	368,325
Bank of Woodruff, Woodruff, S. C.....	40,700	10,500	256,874
The Savings Bank of Richmond, Richmond, Va.	200,000	200,000	2,198,163
Peoples Bank of Harrisonburg, Harrisonburg, Va.	150,000	20,000	554,154
Peoples Bank & Tr. Co., Chase City, Va...	100,000	10,000	173,005
ATLANTA:			
American Trust & Savings Bank, Birmingham, Ala.	500,000	250,000	5,836,700
Bank of Eufaula, Eufaula, Ala.....	100,000	14,000	378,828
Sullivan Bank & Trust Co., Montgomery, Ala.	250,000	25,750	605,582
Bank of Iota, Iota, La.....	25,000	114,204
Hibernia Bk. & Tr. Co., New Orleans, La.	1,500,000	2,000,000	25,081,516
Jefferson Tr. & Sav. Bk, Gretna, La.....	30,000	20,000	402,332
Metropolitan Bk., New Orleans, La.....	400,000	200,000	4,077,889
Canal Bk. & Tr. Co., New Orleans, La....	2,000,000	500,000	21,210,372
Union Bank of Pike, Summit, Miss.....	25,000	4,000	165,516
Savannah Bk. & Tr. Co., Savannah, Ga....	630,000	570,000	8,415,862
CHICAGO:			
Central Trust Co. of Illinois, Chicago, Ill.	6,000,000	1,000,000	54,074,035
Foreman Bros. Bkg. Co., Chicago, Ill....	11,500,000	500,000	16,141,352
Merchants Loan & Tr. Co., Chicago, Ill..	3,000,000	8,000,000	109,517,884
Standard Tr. & Sav. Bank, Chicago.....	1,000,000	500,000	9,980,043
State Bank of Chicago, Chicago, Ill.....	1,500,000	3,000,000	38,004,507
Union Trust Co., Chicago, Ill.....	1,500,000	1,500,000	37,348,934
Hyde Park State Bank, Chicago, Ill.....	200,000	50,000	1,840,530
Elmhurst State Bank, Elmhurst, Ill.....	60,000	25,000	703,766
State Bank of Evanston, Evanston, Ill...	150,000	200,000	4,142,457
Commercial Trust & Savings Bank, Joliet, Ill.	100,000	5,000	569,684
St. Joseph Valley Bank, Elkhart, Ind....	100,000	50,000	2,484,247
Commercial Sav. Bk., Mason City, Iowa...	100,000	14,000	1,117,160
Commercial & Sav. Bk. of Albion, Mich..	75,000	40,000	798,486
Industrial Sav. Bk., Flint, Mich.....	250,000	250,000	4,307,935
Chicago Sav. Bank & Tr. Co., Chicago, Ill.	1,000,000	200,000	12,733,891
Fruit Growers State Bank, Saugatuck... Mich.	50,000	10,000	476,786
Central State Bank of Jackson, Jackson, Mich.	100,000	26,000	1,062,781
Peoples State Bank, Detroit, Mich.....	2,500,000	2,500,000	77,761,759
Exchange Sav. Bk., Mt. Pleasant, Mich...	50,000	30,000	971,176
Peoples Tr. & Sav. Bk., Clinton, Iowa....	300,000	300,000	5,179,744
Iowa Loan & T. Co., Des Moines, Iowa...	500,000	100,000	7,436,047
Ottumwa Sav. Bank, Ottumwa, Iowa....	100,000	30,000	1,205,090
Bankers Loan & Tr. Co., Sioux City, Iowa.	100,000	5,000	277,323
Bank of Wisconsin, Madison, Wis.....	300,000	60,000	2,156,438
Marshall & Ilsley Bk., Milwaukee, Wis...	1,000,000	700,000	17,405,264
Badger State Bank, Milwaukee, Wis.....	200,000	2,000	1,506,471
Citizens Bank, Clinton, Wis.....	50,000	10,000	478,360
St. Clair County Savings Bank, Port Huron, Mich.	100,000	50,000	1,319,436

	NAME AND LOCATION	CAPITAL	SURPLUS	TOTAL RESOURCES
ST. LOUIS:				
	German Savings Institution of St. Louis, St. Louis, Mo.	1,500,000	1,000,000	19,261,222
	International Bk. of St. Louis, Mo.	500,000	500,000	6,981,718
	Mercantile Tr. Co., St. Louis, Mo.	3,000,000	6,500,000	40,732,458
	Mississippi Valley Tr. Co., St. Louis. . .	3,000,000	3,500,000	30,414,523
	St. Louis Union Bank, St. Louis, Mo.	2,500,000	2,500,000	44,389,921
	Lafayette South Side Bk., St. Louis, Mo. .	800,000	400,000	12,604,890
	Franklin Bank, St. Louis, Mo.	600,000	700,000	8,961,674
	German-American Bank, St. Louis, Mo. . .	1,000,000	700,000	9,239,685
	German Insurance Bk., Louisville, Ky. . .	250,000	500,000	7,307,484
	Union & Planters Bank & Trust Co., Mem- phis, Tenn.	1,400,000	200,000	15,307,795
MINNEAPOLIS:				
	Sault Sav. Bk., Sault Ste. Marie, Mich. . .	100,000	35,000	1,140,382
	Bankers Tr. & Sav. Bk., Minneapolis, Minn.	1,000,000	200,000	2,197,408
	German-American Bk., Minneapolis, Minn.	200,000	200,000	4,689,159
	Peoples Bk. of St. Paul, St. Paul, Minn. .	300,000	50,000	2,280,204
	Merchants Bk. of Winona, Winona, Minn. .	100,000	50,000	2,581,970
	First State Bank, Opheim, Mont.	25,000	5,000	229,183
	Hingham State Bank, Hingham, Mont. . . .	35,000	335,296
	Yellowstone Valley Bank & Trust Co., Sidney, Mont.	100,000	5,000	748,601
	Hettinger State Bk., Hettinger, N. Dak. .	25,000	3,500	282,089
	Bank of Williston, Williston, N. Dak. . . .	50,000	113,071
	Sioux Falls Sav. Bk., Sioux Falls, S. D. .	200,000	23,000	3,852,236
KANSAS CITY:				
	International Trust Co., Denver, Colo. . . .	500,000	500,000	13,803,659
	Fort Scott State Bk., Fort Scott, Kan. . .	100,000	26,000	748,859
	Southwest State Bk., Wichita, Kan.	200,000	9,000	1,521,337
	Commerce Trust Co., Kansas City, Mo. . . .	1,000,000	750,000	32,897,159
	Fidelity Trust Co., Kansas City, Mo.	1,000,000	1,000,000	14,461,776
	Bank of Lewellen, Lewellen, Neb.	25,000	10,000	250,820
	Fairview State Bank, Fairview, Kan.	30,000	15,000	291,985
DALLAS:				
	First State Bank, Bonham, Tex.	100,000	14,000	543,354
	First State Bank, Bremond, Tex.	50,000	25,000	232,823
	Central State Bank, Dallas, Tex.	200,000	5,000	1,698,236
	First State Bank, Dallas, Tex.	250,000	28,000	3,016,796
	First State Bank, DeKalb, Tex.	25,000	25,000	2,638,304
	Farmers & Merchants State Bank, Edge- wood, Tex.	35,000	7,000	95,675
	First State Bank, Hamlin, Tex.	25,000	1,750	158,894
	Lubbock State Bank, Lubbock, Tex.	100,000	13,000	837,114
	Citizens State Bank, Memphis, Tex.	75,000	26,400	377,603
	First State Bank, Savoy, Tex.	25,000	3,500	120,175
	First State Bank, Wolfe City, Tex.	50,000	20,000	235,461
SAN FRANCISCO:				
	Spokane & Eastern Trust So., Spokane, Wash.	1,000,000	200,000	20,078,867
	Coffman Dobson & Co., Chehalis, Wash. . .	50,000	100,000	1,493,790
	Live Stock State Bk., North Portland, Ore.	100,000	10,000	872,846
	Genesee Exchange Bk., Genesee, Idaho. . .	25,000	12,500	482,091
	First Savings & Trust Co. of Whitman County, Colfax, Wash.	50,000	15,000	369,711



International Banking and Finance

SPECIAL

**THE BANKERS
MAGAZINE**

SECTION



Coupling up trade

A long and intimate experience in the specialized treatment of Bills of Lading and related documents enables us to safeguard fully the interests of correspondents.

IRVING NATIONAL BANK

WOOLWORTH BUILDING NEW YORK

Strictly a Commercial Bank Resources over \$100,000,000

Development of the Japanese Investment Market and Co-operation of the United States

By K. HASHIMOTO, Director and Manager T. Nomura & Co.,
Osaka, Japan

THE capital movement of the world is very much like that of human migrations. The growth of population in one area and the accumulation of wealth are subject to sudden contraction by wars, by political or



K. HASHIMOTO

religious persecution, driving the people to seek a happier life with more attractions of wealth, climate, and greater political and religious equality.

The original money movement began in Northern Italy, passed to Spain, to Portugal, to Holland, to France and to England; where, for over thirty years a large amount of floating capital was available to supply not only domestic requirements, but demands from all parts of the earth.

At the beginning of the Twentieth Century American capital started to overflow into Canada and Central and South America; and since three years ago, after the opening of the present war, the United States has been gaining financial power throughout the world.

Japan established a Stock Exchange thirty-nine years ago; and in June of 1917 she had outstanding domestic government loans amounting to 1,097,465,127 yen; and foreign government loans amounting to 335,000,000 yen.

The fluctuations of New York Stock Exchange prices have a direct and immediate effect on the Japanese Stock Exchange. Under present conditions, with prices so low in New York, Japanese capital may get the cheapest of the European government municipal bonds.

It has for a long time been my ambition to contribute an article about Japanese investment securities and their relation to the international money market, but unfortunately the following reasons made it impossible to do so:

U. S. Army or Navy Red Cross or Y. M. C. A.

Letters of Credit are the safest and most convenient medium for carrying funds.

During the war we are issuing such Credits, *free of commission*, to officers and men in the U. S. Army and Navy, and to those engaged in Red Cross or Y. M. C. A. work.

We have also sent our American representative to France for the convenience of our friends, with headquarters at the office of the Credit Commercial de France, 20 Rue Lafayette, Paris.

BROWN BROTHERS & CO.

Philadelphia

NEW YORK

Boston

BROWN, SHIPLEY & COMPANY

Founders Court, Lothbury
LONDON, E. C.

123 Pall Mall
LONDON, S. W.

First: The Japanese economic condition itself was not sufficiently developed.

Second: The amount of capital of Japanese corporations was small.

Third: The financial condition of Japanese corporations was not safe enough.

Fourth: Japan itself was not well known among nations.

After the Russian-Japanese war in 1905, Japan obtained greater recognition among other nations on account of her military success, but at the same time Japan was known as a nation having a large debt, owing one billion and a half yen to America and European countries.

Since this great military and economic struggle Japan has given much attention to National development and financial management and has imported a large amount of capital from abroad for use in railroad, industrial and municipal enterprises; and finally, she has

established sound economic conditions.

At the beginning of the present European war, Japan entered the war on the side of the Entente and supplied large quantities of war material to Europe, the same as the United States is doing.

IMPROVED FOREIGN TRADE

For many years Japan's foreign trade showed an excess of imports amounting to some four to ninety-six million yen, but since 1914 it has changed entirely, favoring Japan 300 to 400 million yen yearly, and this year we are expecting over 700 million yen. The accompanying table shows the record of the past ten years.

It will be noted that ten years ago Japan had a total trade—import and exports—amounting to 926,881,000 yen and last year to 1,883,895,000 yen. Ten years ago the excess of imports over exports amounted to 62,052,000 yen; last year the excess of exports over imports amounted to 371,040,000 yen.

COX & CO. (France) Ltd.

place their branches in France at the disposal of the Military and Naval forces of the United States, in Europe, for the remittance of funds and general banking business.

This bank was formed as a subsidiary of Cox & Co., founded in 1758, 16 Charing Cross, London; the official British Army Agents, for the convenience of the British Army in France.

Branches have been established with a British Staff at all the chief military bases.

Paris, Rouen, Havre, Boulogne, Amiens, Marseilles,
and agencies at

COX & CO., 16 Charing Cross, London,
and

LONDON & SOUTH-WESTERN BANK, LTD.,
170 Fenchurch Street, London.

who are the joint proprietors.

Year	Exports Yen.	Imports Yen.	Excess Yen.
1907	432,412,000	494,467,000	*62,054,000
1908	378,245,000	436,267,000	*58,011,000
1909	412,112,000	394,198,000	†18,913,000
1910	458,428,000	464,233,000	*5,804,000
1911	447,433,000	513,805,000	*66,371,000
1912	526,981,000	618,992,000	*92,000,000
1913	633,460,000	729,431,000	*96,971,000
1914	591,101,000	595,735,000	*4,634,000
1915	708,306,000	532,449,000	†175,857,000
1916	1,127,468,000	756,427,000	†371,040,000

*Excess of Imports. †Excess of Exports.

JAPAN'S INVESTMENT MARKET

The investment market of Japan is remarkably advanced. Ten years ago Japan had 10,087 corporations having a total capital of 1,114,227,000 yen; while last year the number of corporations had increased to 17,149 and their total capital 2,167,724,000 yen. This year the majority of the corporations

having increased their capital it will reach 3,000,000,000 yen.

Besides these amounts there are corporation bonds amounting to about 800,000,000 yen and about 3,000,000,000 yen municipal bonds. The following shows Japanese securities, not including foreign loans:

	Yen.
Government bonds	1,000,000,000
Corporation stocks (full paid)	3,000,000,000
Corporation bonds	800,000,000
Municipal bonds	300,000,000
Total	5,100,000,000

The business of the banks, railroads, steamships, spinning, sugar refining and chemical industries is very profitable. Their surplus and undivided profits amount to almost the same as the capital. Some corporations have paid in all fixed capital and debts, getting large profits by their own earned capital. For example, take a spinning company. The establishment of a new company requires seventy yen per spindle. If the company have 200,000 spindles they

NOYES & COMPANY

Established 1879

Foreign Bills
Government and Municipal Bonds

8, Place Edouard VII.

PARIS - FRANCE

The First National Bank of Chicago

welcomes and appreciates the accounts of banks and bankers. Its extensive clientele, developed during more than fifty years of consistent, considerate service, is splendid endorsement of the agreeable and satisfactory relations maintained with correspondents.

Capital and Surplus, \$20,000,000

JAMES B. FORGAN
Chairman of the Board

F. O. WETMORE
President

must have a fixed capital of at least 15,000,000 yen. Most of the spinning companies of Japan paid in almost all of the fixed capital and the present average unpaid fixed capital for a spindle will be not over ten yen. Moreover, those companies have well trained, skilled laborers, valuable good will and experienced executives. Some companies have large undivided profits and will pay handsome dividends to stockholders with interest from their large undivided funds. These are an example of the business conditions of Japan at the present time.

The securities of Japan, however, are cheap and afford a high yield, say eight per cent. to ten per cent. This will show that the rate of money is comparatively higher. Japan offers a great field for the safe and profitable investment of capital in shipping, railway, electric and gas works, harbor, building, steel works, financial institutions and many lines of manufactures; not only in Japan proper, but in Korea, Manchuria,

South Sea Islands and China, which are closely allied geographically and economically.

The present European war changed everything in the world, especially international financial conditions. In 1914 the United States was indebted about three and one-half to four billion dollars to European countries; and up to the end of March of this year the United States issued foreign loans amounting to about \$2,400,000,000 and bought back their securities which were held in Europe to the extent of about \$2,200,000,000. These \$4,600,000,000 show that the United States has changed as a nation in regard to giving credit; and besides these large sums, the United States issued a first Liberty Loan of about \$2,000,000,000 and a second Liberty Loan of \$3,000,000,000.

The capital movement is going on continuously, changing history all the time. New York may claim to be the financial center of the world, at least at the present time; and in the same

BANKAKTIEBOLAGET SÖDRA SVERIGE

Head Office : HELSINGBORG, Sweden

Branches : STOCKHOLM, GOTHENBURG, MALMÖ, BORÅS and in 48 other
Places in Sweden

(\$0.26 = 1 Kr.)
Capital Paid Up Kr. 30,000,000
Surplus About Kr. 15,000,000
Resources About Kr. 260,000,000

The organization and excellent relations of this Bank secure to its clients the most efficient handling of their business on moderate terms
Inquiries and applications for terms are cordially invited and will find prompt attention
Principal New York Correspondents { The Mechanics & Metals National Bank
The National City Bank of New York

way Japan is gaining strong financial power. In the future the United States and Japan must cooperate in the investment market; and for cooperation of financial arrangements I would propose to list securities in each market so as to open wider the market for investment.

CLOSER FINANCIAL RELATIONS BETWEEN ...JAPAN AND THE UNITED STATES

The reasons for making such financial arrangements may thus be plainly summarized:

First: Japan has many large corporations having large amounts of capital paying high dividends for a number of years; but the present war made her corporations of the highest type, increasing capital and surplus profit. It is a fitting time to introduce these

good and safe securities into the international investment market.

Second: The stock market of Japan has advanced to such a degree that the movement of the New York Stock Exchange prices has a direct, immediate effect on the Japanese Stock Exchange prices. Therefore, there is direct relation between the New York market and the Japanese market.

Third: The financial center of the world has moved from London to New York since the opening of the present war. London had many foreign securities, as the financial center, before the war; and in the same way, New York must list many foreign securities to make herself the real center of the world market.

Fourth: It is natural for the investor to follow good securities, just as water runs down into the lower place from a high place. In the same way the Japanese good securities will come into the New York market sooner or later, in accordance with the natural law. But our duty is to introduce these good securities from seller to buyer or investor, without waiting for the slow processes of the natural law.

Fifth: It will be a mutual benefit to open the way of supply and demand, establishing the broader investment field; like establishing a railroad before a country is not over-crowded, to be prepared for future rapid immigration. Japan has many foreign investors for Japanese securities already: for example, Mr. Brady of New York city, holds a large share of the stocks of the Osaka

Liberty Trust Company

8, Place Edouard VII.

Total Resources Over

\$10,000,000

PARIS - FRANCE

Redmond & Co.

33 Pine Street
New York

High-Grade Investment Securities

Government
Municipal
Railroad
Public Utility

Correspondents will kindly indicate their individual requirements to Dept. B

Gas Co. The group of Crupp of England hold many stocks of the Japan Steel Co. Therefore, if we open the way to the handling of such securities in New York it will surely bring about a rapid increase in such business.

Sixth: The leading Japanese securities mostly have an English translation on the back of the securities—that is, one side written in Japanese and the other in English, thus facilitating their introduction into the American market.



Foreign Industrial Financing

By EUGENE WERA

THE new era in American finance has magnificently developed foreign government loans, but it seems that the second step, namely, that of financing foreign industrial enterprises, is not being prepared with the same impetus, in order to maintain the financial preminence and influence of America in the post-bellum opportunities.

Of course, no concrete programme of

action can be laid down as long as the consequences of the war are unknown, although it will be the purpose of the following to present an outline of the general principles which are suggested chiefly by European conditions.

TWO FUNDAMENTAL DIFFICULTIES

The problem of overseas industrial investment involves two fundamental difficulties, namely:

THE BANK OF CHOSEN

Incorporated by Special Charter of Imperial Japanese Government

(\$0.50 — 1 Yen)

Subscribed Capital, Yen 20,000,000

Paid-Up Capital, Yen 12,500,000

Head Office, Seoul, Korea

Principal Branches:

KOREA: Chemulpo, Pyongyang, Wonsan, Fusan

MANCHURIA: Mukden, Dairen, Changchun, Newchwang, Harbin, Antung

JAPAN: Tokyo, Osaka, Kobe

CHINA: Tsingtau

Affiliated Bank:

VLADIVOSTOK: Matsuda Bank

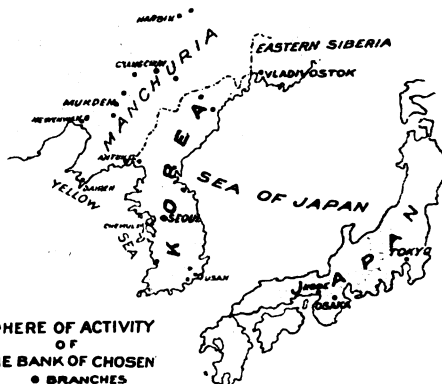

Principal American Correspondents:

Guaranty Trust Company of New York
Irving National Bank, New York

National City Bank of New York

National Bank of Commerce in New York

Yokohama Specie Bank, New York and
San Francisco

Canadian Bank of Commerce, San Francisco and Seattle

1. The absence of a market in America for foreign securities;

2. The lower earning power of European industry as compared with that of America.

The development of an international stock market in New York would require a long process of education, which the circumstances cannot afford to go through; for the opportunity will not wait. Indeed, the war has not weakened economically, to any great extent, the countries involved; credit has entered a new phase of evolution; there is therefore little doubt that the men and the institutions which were able to finance the war will be equal to the industrial problems confronting them when peace comes. Consequently a quicker though conservative way of trading in foreign securities must be devised.

American capital may be invested in foreign industry either in bonds or in stocks.

The yield of bonds will not appeal to the American investor; or, if it should the interest charge is likely to become an overwhelming burden for European enterprises and to develop a risk which is not compensated by the increase of the rate of interest.

Stock financing may be realized indirectly through an American holding company. This way is certainly commendable for averaging the risk; but that very quality will deprive the stockholder of most opportunities for speculation.

The selling direct of foreign industrial stock is not actually feasible in New York; that stock is, however, what the speculator is willing to buy, had he facilities to sell it at will and to ascertain the value of his purchase.

A ready market exists on the bourses at Paris and at Brussels where the operations can be conducted by cable. Through this channel American speculators can engage in trading either between themselves or with foreign specu-

lators. The buying capacity of that group of foreign traders may be much less than the volume of trade, its role being similar to that of the reserve in a bank; that is, to maintain the confidence of each individual American trader in regard to the salability of his holding.

It is probable that in this way the participation of American speculators in the new spirit of investment, based upon the earning power of the old countries, can be readily secured, if a closer coöperation be provided for between finance and industry.

From 1896 on, we had in Belgium an example of such a movement which developed as quickly as intensively. In spite of their proverbial conservatism, Belgians invested 500,000,000 francs in forty-three companies in Russia, and 800,000,000 francs in 110 companies scattered all over the world.

HOW TO INVEST PROFITABLY

The next point is to determine how to invest profitably, in spite of the lower return of European industry.

Granted that the inducement offered by foreign opportunities be stronger than those which will be open at home, it appears that American capital cannot be simply invested over there in the old way, but that it must work on the American plan, which means financing specialized large scale production under central control, in order to increase its earning power above the customary level.

The rehabilitation, in the devastated countries, of industries just as they were before the war cannot be sustained for a moment; indeed, the nature, volume, and direction of trade will be changed according to the new market conditions. Hence, the character and importance of the manufacturing enterprises to be financed should be carefully studied from a world-wide point of view. Many old businesses which were operated against too high competition will improve through consolidation. The management of many others should be mod-



Advice to Investors

Purchase your securities through responsible dealers who have proper facilities for investigations and a reputation to maintain for reliable advice.

K. N. & K. are always posted on general market conditions, and their views are at the disposal of investors through their monthly review of

"The Investment Situation"

Write for pamphlet L-I

Knauth · Nachod & Kuhne

Members of New York Stock Exchange.

**Equitable Building,
NEW YORK CITY.**

ernized. The heads of industries in those countries are generally technical men, and the consequent result is that their selling department is often quite undeveloped. Their field being thus narrowly limited, they cannot specialize and grow into big concerns as they might do. Therefore, a control of the investment is just as necessary as the capital itself.

Such a plan involves the coöperation of a combination of auxiliary companies, operating on both sides of the ocean and disposing of adequate means of control, information, and influences.

As time goes on and the commercial object of the movement is accomplished, the American holdings may be liquidated; the European people will be very glad to buy back their own stock, paying for the American initiative a much larger premium than the most optimistic would dare to expect.

London and River Plate Bank, Limited.

HEAD OFFICE: 7 PRINCES STREET, E.C., LONDON.

Paris Branch: 16 Rue Halevy.

Antwerp Branch: Temporarily in London.

	(\$5-£1.)
CAPITAL (Authorized) - - - - -	\$20,000,000
SUBSCRIBED CAPITAL - - - - -	15,000,000
PAID-UP CAPITAL - - - - -	9,000,000
RESERVE FUND - - - - -	10,000,000

DIRECTORS.

E. ROSS DUFFIELD, Esq., *Chairman*
 The Hon. HUGO BARING.
 WILLIAM T. BRAND, Esq.
 JOHN G. GRIFFITHS, Esq., M.V.O.

ROBERT A. THURBURN, Esq., *Managing Director*
 KENNETH MATHIESON, Esq.
 HERMAN B. SIM, Esq.
 DAVID SIMSON, Esq.

LONDON BANKERS.

THE BANK OF ENGLAND.

THE LONDON COUNTY AND WESTMINSTER BANK, LTD.

BRANCHES IN SOUTH AMERICA :

BRAZIL:—Para, Pernambuco, Rio de Janeiro, Santos, Sao Paulo, Bahia, Curitiba, Victoria, also an agency at Manaus. URUGUAY:—Montevideo, Montevideo Sub-Agency, Paysandu and Salto.

ARGENTINA:—Buenos Aires, Rosario de Santa Fe, Mendoza, Bahia Blanca, Concordia, Tucuman, Cordoba, Parana. Also in Buenos Aires:—Barracas al Norte, Once, Boca, Calle Santa Fe 2122 and Calle B. de Irigoyen 1138. CHILE:—Valparaiso, Santiago.

Correspondents in all other places of importance in these South American Countries.

Documentary Bills Bought, Advanced Upon or Received for Collection.
 Drafts and Cable Transfers Sold on all Branches and Agencies.

Commercial and Travelers Letters of Credit Issued.

New York Agency 51 Wall Street,

W. B. ROBBINS, AGENT.

The Prosperity of Japan

(Contributed to "The Americas" by the Special Oriental Representative of The International Banking Corporation.)

NEVER in her entire history has Japan been so prosperous as she is to-day. Never were her factories busier or the volume of her foreign trade larger. She has taken advantage of her comparatively neutral attitude in the world war and her strategic position in Asia, and has not only almost monopolized the markets of the Far East, but has exerted all of her energy to build up a foreign commerce with every country on the globe. She is sending trade commissions to every land, establishing new steamship routes to Russia, to China, to Australia, to South and North America, to Africa, to Europe, to India, the South Sea Islands, and all the time her shipyards are rushing work on new ships to handle the business when it is fully developed.

Japan is progressive, full of energy, and thoroughly alive to the importance of her foreign trade.

The following figures show graphically the progress made in recent years by Japan in her foreign commerce:

Year	Exports and Imports Combined
1872	Yen 43,201,000
1902	Yen 530,034,000
1912	Yen 1,145,974,000
1914	Yen 1,186,837,000
1915	Yen 1,240,756,000
1916	Yen 1,883,896,000
1917 (six months)	Yen 1,156,810,000

During the first six months of 1917, the foreign trade of Japan amounted to yen 1,156,810,000, an increase of thirty-six per cent. over the figures for the corresponding period of last year,

The Union Bank of Manchester, Limited

Head Office
17 York St., Manchester, Eng.

Liverpool Office
45 Castle St., Liverpool, Eng.

and branches covering the whole of the district tributary to these two cities, and also WEST YORKSHIRE; including SHEFFIELD, BRADFORD, SALFORD, BIRKEN-HEAD, OLDHAM, BOLTON, BURY, ROCHDALE, STOCKPORT, HALIFAX (ENG.), HUDDERSFIELD, etc., etc.

(\$5=£)

Nominal Capital	\$12,500,000
Paid-up Capital -	2,750,000
Reserve Capital	3,500,000
Subscribed Capital	6,250,000
Reserves	1,903,470
Surplus over Liabilities	8,153,470

Bankers in the United States and Canada are invited to make use of the Bank's services for all kinds of banking business in the district where the Bank operates, and in Great Britain generally. Collections promptly dealt with, and proceeds remitted by draft or cable transfer on New York, or as desired. Favorable terms.

and if the present volume continues throughout the remainder of the year, Japan's foreign trade for 1917 will show an increase of 100 per cent. over that of 1914.

So far this year, exports have increased 50.8 per cent. and imports 17.8 per cent. over the first half of 1916. This is all the more remarkable when one considers that in normal times the first half of each year usually sees an excess of imports over exports. This year, however, exports not only have exceeded imports month by month, but the amount of excess has steadily increased, and it is predicted that this tendency may be more apparent in the second half of this year.

The export trade with Europe, Asia, North and South America, and Africa for the term under review exhibited a considerable increase as compared with the corresponding period of 1916, and an enormous gain when compared with the like period before the outbreak of

the war. The exports to other Asiatic countries showed an increase of forty-five per cent. as compared with the first half of 1916, and 123 per cent. more than the same period in 1914. Japan's export trade to China, British India, and the South Sea Islands increased during the first half of 1917 over the same six months last year, but exports to Asiatic Russia fell off somewhat.

In her trade with Europe this year, exports from Japan increased 120 per cent. over the like period of last year, and 148 per cent. over that prior to the war, this being chiefly due to the heavy increase shown in the trade with Great Britain, France, Italy and Russia.

INCREASED TRADE WITH NORTH AND SOUTH AMERICA

The shipments to North America for the term showed an increase of thirty-seven per cent. over the first six months of 1916, and 160 per cent. over the first half of 1914. The exports to

Leu & Co.'s Bank, Limited

Zurich, Switzerland

FOUNDED 1755



Capital Fully Paid Up } Frs. 46,000,000
and Reserve Fund }

Every description of Banking and Foreign Exchange business transacted.

Drafts and Letters of Credit issued payable in all parts of the world.

Telegraphic Transfers Effected.

Booking and Travel Department.

This bank is thoroughly equipped for handling business between the United States, Switzerland and other European countries.

LONDON AGENTS: London and Southwestern Bank, Ltd.; Credito Italiano; London County and Westminster Bank, Ltd.

Agents and Correspondents in all parts of the World

MANAGERS

CHAS. J. BRUPBACHER

H. DIETLER

R. G. BINDSCHEDLER

South America increased fifty-five per cent. over last year and 100 per cent over the first part of 1914. The increased business was with Peru, Chile, Argentina, and Brazil.

Japan's exports to Africa during the same time showed a gain of 210 per cent. over last year, and 989 per cent. over the pre-war period. Exports to Australia decreased fifteen per cent. and to Asiatic Russia eighteen and four-tenths per cent. during the first half of this year as compared with last. These decreases are attributable to the shortage of bottoms, unsatisfactory transportation facilities in Russia, and the embargo on imports, supplemented by the fact that last year the exports had been too large.

Turning to the import trade, it may be said that the condition for the term under review was somewhat different from the export trade. Imports from other Asiatic countries and Europe exhibited a decrease as compared with the

corresponding period of last year, the decreased ratio in the former being three and two-tenths per cent. and that in the latter nine and four-tenths per cent.; while a falling off of six and four-tenths per cent. was witnessed in the former and sixty-one and five-tenths per cent. in the latter as compared with the six months prior to the outbreak of the war. On the other hand, the imports from North and South America, Africa and Australia for the six months of this year exhibited an increase over the like period of 1916, and a considerable gain over that before the war. The imports from North America showed an increase of seventy-one and seven-tenths per cent. over last year, and 110 per cent. over the pre-war period; those from South America an increase of eighty-one and nine-tenths per cent. over last year, and 205.5 per cent. over 1914; those from Africa a gain of seventy-five and four-tenths per cent. over 1916, and seventy-nine and two-tenths per cent.

MERCANTILE BANKING COMPANY, Ltd.

Avenida Francisco I. Madero No. 12

CITY OF MEXICO, D. F.

Capital and Surplus, \$600,000.00

GEO. J. McCARTY, President K. M. VAN ZANDT, Jr., Vice-President and Manager H. C. HEAD, Cashier FCO. COUDURIER, Asst. Cashier

Members: American Bankers' Association, Texas Bankers' Association, Mexico City Clearing House

GENERAL BANKING TRANSACTED TELEGRAPHIC TRANSFERS

Foreign Exchange Unsurpassed Collection Facilities Throughout the Republic

SEND US YOUR MEXICO BUSINESS

WRITE US UPON ANY SUBJECT WHICH MAY BE OF INTEREST TO YOU IN THE REPUBLIC OF MEXICO. P. O. Address: Apartado 1846.

over the pre-war period; those from Australia an increase of one and seven-tenths per cent. over last year and 206.6 per cent. over 1914.



Conditions in Switzerland

LEU & CO.'S BANK, Ltd., Zurich, in its bank letter dated September, 1917, gives some interesting information regarding conditions in Switzerland. With the continuation of the great war, it says:

The economical war is increasing in intensity, and Switzerland suffers more and more from the disadvantages of her geographical situation. Being completely shut off from free access, and wedged in between both groups of Powers, she is being increasingly restricted in her economical freedom owing to state monopolies and the fixing of contingents of imports. But the most difficult question is that of providing our population with food, and the obtaining of raw materials for our highly developed industry. Our stocks of raw material have become seriously depleted, and we are more than ever dependent upon regular supplies from outside sources. In spite of the scrupulous fulfilment on the part of our authorities of all obligations imposed upon them, our imports are far below our most necessary requirements. Increasing transport difficulties, and especially the absence of sufficient tonnage available for Switzerland, which is not sufficient to supply even the half of our requirements, prevent the absolutely needed supplies from reaching our country.

Although Swiss national economy suffers very considerably from the unfavorable conditions, there are some industries which are able to show good

returns. The majority of the balance sheets have been issued, and have realized the results which were expected. On the other hand, trade reports reveal almost without exception a feeling of serious anxiety as to the possibility of keeping factories and other works employed. As to the issue of new capital, the letter states:

This has further increased during the last half-year, notwithstanding the enormous advance in prices, as well as excessive freight rates and increased cost of living. Deposits in savings banks and investments in bonds of the Swiss Cantonal banks—in spite of considerable repurchases of Swiss securities from abroad, and important investments in Swiss loans—show for the first five months of 1917 an increase of 63 million francs, and amounted at the end of May to 2,161,800,000 francs. The balance of loans made by the Swiss Federal Loan Office has during the same period decreased from 31,400,000 to 24,500,000 francs, and at the end of June showed a decrease of 17,500,000 francs as compared with the same period in 1916. It is also satisfactory to record that the number of failures shows a considerable decrease; in the first half of 1917, the number was only 146, as compared with 411 in the first half of 1915.



Foreign Banking Shares

THE London Economist of Oct. 20 devotes the usual space to the course of bank shares. It states that the market for bank shares has been extraordinarily steady and there is no sign of investors becoming dissatisfied with a 5½ to 6½ per cent. yield on the securities. The Economist believes

it is clear that investors have a strong belief in the present and future of English banking.

On Australian bank shares the yield varies from $4\frac{3}{8}$ to $7\frac{3}{8}$ per cent., the average being about 6 per cent. Egyptian and Indian shares have been more lively and the price of Eastern bank shares is higher now than it was before the war, the yields being so low as to be justified only by a certainty of higher dividends in the future.

South American shares show little change, but South Africans have been firm. The feature of this list is again the National Bank of South Africa, whose shares have risen by over a point in 12 months and are $1\frac{1}{4}$ higher than they were before the war. This bank has recently been increasing its connections and its profits and established a large business with the United States through its New York agency, when American bonds were being shipped in their millions from London to the United States.

The Standard Bank of South Africa

THE Standard Bank of South Africa, Limited, which has an established agency in New York City at 68 Wall Street, under the management of W. H. Macintyre, in its June 30, 1917, statement shows deposits of £29,396,591 as compared with £26,243,681 on June 30, 1916. The bank has a paid-up capital of £1,548,525.



Statement Yokohama Specie Bank

AS of June 30, 1917, the Yokohama Specie Bank, Limited, shows total deposits of yen 396,536,836 and total resources of yen 642,891,140. Gross profits for the half year amount to yen 39,332,616. The bank paid a dividend at the rate of 12 per cent. per annum and has a capital of yen 36,000,000.



Bank Opens Argentine Branch

JOHN CONE is manager of the New York Agency of the Anglo-South American Bank, Limited, which is located at 60 Wall Street. Further evidence of the activity of the Anglo-South American Bank is the establishment of a new branch at San Julian, Argentine.

New Branch in Tsingtau

THE Bank of Chosen announces the opening on Oct. 22 of a new branch in Tsingtau, China. This action is indicative of the enterprising and progressive spirit of the Bank of Chosen, which aims to cover its field as completely and efficiently as possible.



Book Reviews

THE SYSTEM OF FINANCIAL ADMINISTRATION OF GREAT BRITAIN. By W. F. Willoughby, W. W. Willoughby and S. M. Lindsay. Appleton & Co., N. Y. Price, \$2.75.

The first authoritative detailed account of the system of financial administration in Great Britain, which has the oldest, best developed and foremost budgetary system in the world.

A notable work of great interest and value to executives, legislators, financial officers, journalists, librarians and students of political science.



THE LAW OF BANKRUPTCY. Compiled by C. W. Gerstenberg. Prentice-Hall, Inc. Price, \$1.50.

A text for business men and students of business, with copies of the National Bankruptcy Act, general orders of the Supreme Court and the official forms; accompanying, under separate cover, a pamphlet of answers to 125 problems.

The purpose of the book is to supply to the layman a text particularly prepared for him on bankruptcy.



STORY OF THE AUTOMOBILE. By H. S. Barber. A. J. Munson & Co. Price, \$1.50.

The history and development from 1760 to 1917 of the automobile shows the struggle of man to devise a means of propelling a vehicle without animal power.

First authentic story ever written from the investors' standpoint on the third largest industry in the United States—a complete analysis of present conditions, a forecast of the future growth and expansion of the automobile, truck and tractor.

Lists all makes of cars with prices, illustrated with charts.



1600 BUSINESS BOOKS. By S. B. Ball. H. W. Wilson Co., White Plains, N. Y. Price, \$1.50.

A comprehensive, yet simple guide to books, periodicals, and directories relating to business, commerce and finance that may be found in the business branches of public libraries.

Published to give business men a ready access to the result of efforts to exploit a field of print as yet but little known. Arranged by authors, titles and subjects.



HOW TO ANALYZE INDUSTRIAL SECURITIES. By Clinton Collver. Moody's Investors Service, N. Y. Price, \$2.00.

This book is particularly intended to be helpful in pointing the way to profitable investment and speculation. It gives methods of determining analysis of industrial securities.

As business factors, the demands, source of supply and competition are taken into consideration.

In the question of management, the personal equation and what it stands for is discussed.

A section is devoted to each of the credit and debit aspects of the balance sheet and one in conclusion to income factors.



APPLIED METHODS OF SCIENTIFIC MANAGEMENT. By F. A. Parkhurst. John Wiley & Sons, Inc., N. Y. Price, \$2.00.

The instructions and forms show substantially the medium employed to in-

corporate the principles of the science of management into an efficient organization suitable for a plant under the specific conditions illustrated.

Theories and generalities have been avoided throughout these pages, and the subject treated from the practical point of view.



Provisions of the War Insurance Law

THE accompanying address of Secretary McAdoo to the officers and enlisted men and women of the Army and Navy of the United States and their relatives, calls attention to the provisions of the War Insurance Law:

The Secretary of the Treasury, through the Bureau of War Risk Insurance, has been charged with the administration of the War Insurance Law enacted by the Congress as a measure of justice to the men and women who have been called to give their lives, if need be, in the service of their country.

I wish to acquaint you with the benefits and privileges which your government has placed at your disposal. It is essential that you and your families at home should know of your and their rights under this law in order that full advantage may be taken of them.

To care for the wife and children of the enlisted man during his service, the War Insurance Law compels him to contribute up to one-half of his pay for their support. The Government, on application, will generously add to this an allowance of from \$5 to \$50 a month, according to the size of the family. Moreover, if the enlisted man will make some further provision himself for a dependent parent, brother, sister, or grandchild, they may be included in the government allowance.

If, as a result of injuries incurred or disease contracted in the line of duty, an officer or enlisted man or an army or navy nurse should be disabled, provision is made for compensation of from \$30 to \$100 a month to him, and, should he die, compensation of from \$20 to \$75 a month will be paid to his wife, his child, or his widowed mother.

In order, however, fully to protect each person and family, Congress has made it possible for every soldier, sailor, and nurse to obtain life and total-disability insurance. This insurance applies to injuries received while he or she is in the service or after he or she shall have left it.

Exposure to the extra dangers of war makes the cost of life insurance in private life insurance companies prohibitive. It was, therefore, a plain duty and obligation

for the government to assume the risk of insuring hundreds of thousands of our soldiers and sailors who are making the supreme sacrifice. Under this law, every soldier and sailor and nurse, commissioned and enlisted, and of any age, has the right, between now and February 12, 1918, to take out life and total-disability insurance up to \$10,000 at very low cost, with the government without medical examination. This right is purely optional. The soldiers and sailors are not compelled to take insurance, but if they desire to exercise the right, they must do so before the 12th of February, 1918. The cost ranges from 65 cents monthly, at the age of 21, to \$1.20 monthly, at the age of 51, for each \$1,000 of insurance. This is a small charge on a man's pay—small in proportion to the benefits it may bring. The premiums will be deducted from his pay, if he desires, thus eliminating trouble on his part.

To provide adequate protection until February 12, 1918, during the period when the soldiers and sailors are learning the details of this law, the government automatically insures each man and woman, commissioned or enlisted in the military service of the United States. It pays the man \$25 a month during total permanent disability; if he dies within twenty years, it pays the rest of 240 monthly installments of \$25 each to his wife, child, or widowed mother.

I desire to call the provisions of this just and generous law to the attention of our officers and enlisted men and women so that they may not be deprived of their rights through lack of knowledge. Full information may be obtained from the Bureau of War Risk Insurance of the Treasury Department, Washington, D. C. I earnestly urge that the officers of the Army and Navy give to the men under their command all possible aid in helping them to understand fully the benefits that this insurance may bring to their families and the small cost at which it may be obtained.

This is the greatest measure of protection ever offered to its fighting forces by any nation in the history of the world. It is not charity; it is simply justice to the enlisted men and women and to their loved ones at home, and each and every one of them should promptly take the benefits of this great law.

Banking and Financial Industry

SPECIAL

**The BANKERS
MAGAZINE**

SECTION



THE LIBERTY NATIONAL BANK *of* NEW YORK

CAPITAL \$3,000,000.00

SURPLUS 3,000,000.00

UNDIVIDED PROFITS 1,010,300.00

OFFICERS

HARVEY D. GIBSON	President
DANIEL G. REID	Vice President
CHAS. W. RIECKS	Vice President and Cashier
ALEXANDER M. HALL, 2nd	Vice President
ERNEST STAUFFEN, Jr.	Vice President
JOSEPH A. BOWER	Vice President
FREDERICK P. McGLYNN	Assistant Cashier
THEODORE C. HOVEY	Assistant Cashier
LOUIS W. KNOWLES	Assistant Cashier
FREDERICK W. WALZ	Assistant Cashier
SIDNEY W. NOYES	Assistant Cashier



HEAD OFFICE OF THE BANK OF MONTREAL, MONTREAL, QUE.

"This site faced the famous Place d'Armes and adjoined the site on which now stands the headquarters building of the Bank. The imposing Corinthian facade, weather beaten and darkened by time, looks out upon Hebert's heroic statue of Maisonneuve, the founder of Montreal, who fought his most terrible battle with the Iroquois Indians on this very spot, and here killed the Indian chief with his own hands."

The Bank of Montreal Centenary

FIVE years after the war between Great Britain and America nine of the leading merchants of Montreal signed articles for the founding of a bank and thus brought into existence the Bank of Montreal, which has just celebrated its centenary. At that time the portion of North America known as Canada consisted only of Upper and Lower Canada, now Ontario and Quebec.

There was no banking system in those days and a large part of the business had to be done on the primitive basis of barter. The Bank of Montreal, the first bank in Canada, discounted bills, effected exchange and issued its own bills, which were printed on a primitive press, worked by the cashier and his assistants.

The bank started with a capital of £25,000 and was so successful that a dividend of 8 per cent was paid from the first year's earnings. Moreover, this success has continued to such an extent that in 100 years only two have been without their regular dividend.

John Gray, an Englishman and a Northwest trader, was the first president and, as most of the directors were Scotchmen, Scotch banking practice was followed and agencies were established in other centers. Thus was founded banking practice in Canada, under which there are a few powerful banks, with branches in practically every center in the Dominion.

During the first year the directors bought a site for a bank building of their own. This site faced the famous Place d'Armes and adjoined that on which now stands the head office of the bank. The imposing Corinthian facade, weather beaten and darkened by time, looks out upon Hebert's heroic statue of Maisonneuve, the founder of Montreal, who fought his great battle with the Iroquois Indians on this spot and

here killed the Indian chief with his own hands.

In 1822 George IV., who was Regent in England, permitted the Great Seal to be attached to the bank's char-



SIR VINCENT MEREDITH
President Bank of Montreal

ter, which was modeled upon the provisions of an American national bank prepared by Alexander Hamilton.

The Canadian Confederation took place in the fiftieth year of the Bank's existence. During the American Civil War branches were established in New York and Chicago and operations of the bank in New York during the war were often on a vast scale. Unusual prosperity prevailed in Canada after the

Civil War and by 1869 the bank's annual profits had passed a million dollars. By 1874 they reached two millions.

After confederation the Bank opened offices in Nova Scotia and New Brunswick and later in Winnipeg and the bank's resources to a marked extent financed the building of the Canadian Pacific Railway, thus wisely foreseeing the great expansion that was to come.

From the time of the opening of the great Northwest the bank has kept pace with the growth of the country and branches have been established rapidly wherever the need of banking accommodation appeared. The capital of the bank was increased from time to time and is now authorized up to \$25,000,000. The reserve fund, with the accumulations of the century, now amounts to \$16,000,000.

During practically the whole 100 years the Bank of Montreal has acted as the fiscal agent of the Government. In a strong position at the outbreak of the present war, it has become stronger as the war went on and the in-

crease in the national wealth is apparent from the statement of the bank. Public deposits rose from \$197,000,000 at the end of the bank's year in 1914, to over \$324,000,000 in April last, and they are still higher now.

Eminent men of the country have always been found on the bank's directorate, including such constructive forces as the Hon. Peter McGill, R. B. Angus, Lord Mount Stephen, Lord Strathcona, Sir George Drummond and others.

The present president is Sir Vincent Meredith, who has grown up in the bank, and the present general manager, Sir Frederick Williams-Taylor, has spent his whole business career in the bank. His experience as representative of the bank in Chicago and for many years in London, has proved of inestimable value in handling the difficult problems resulting from the war.

The one hundredth anniversary of the Bank of Montreal is made the subject of editorial comment on another page of this number of THE BANKERS MAGAZINE.

Alfred L. Aiken to Head National Shawmut Bank

ALFRED L. AIKEN, Governor of the Federal Reserve Bank of Boston, has been chosen to succeed Colonel William A. Gaston as head of the National Shawmut Bank of Boston. The change will take place about January, as soon as Mr. Aiken can complete the great volume of work connected with the flotation of the Second Liberty Loan, in which he has been a conspicuously successful figure. Colonel Gaston will remain as chairman of the board of directors, succeeding Mr. J. P. Stearns, resigned.

Alfred Lawrence Aiken was born in

Norwich, Conn., July 6, 1870. After graduation from the Norwich Free Academy he entered Yale and received his A. B. degree in 1891. He is married and has one son.

Mr. Aiken began his business career with the State Mutual Life Assurance Co., of Worcester, Mass., going from that company in 1894 to become assistant manager of the New England Department of the New York Life Insurance Co., with headquarters in Boston. In October, 1899, he began his active banking career as assistant cashier of the National Hide and

Leather Bank of Boston. In 1901 he became assistant cashier of the State National Bank of Boston, which position he held until July 1, 1904, when he was elected treasurer of the Worcester County Institution for Savings. His success in this field won him the election as president of the institution in January, 1908, which position he held until called, five years later, to the presidency of the Worcester National Bank. Mr. Aiken has also been closely connected with the work of the Massachusetts Bankers Association, having served as its president in 1910.

In November, 1914, Mr. Aiken resigned as president of the Worcester

National Bank to assume his duties as Governor of the Federal Reserve Bank of Boston. In this important and trying position Mr. Aiken has won the respect and admiration of the banking and business interests of New England through his good judgment, tact and sound business ability. He has been largely responsible for the harmonious unification of this Federal Reserve District and his ability at organization is attested by the smoothness with which the great Liberty Loan campaign has been carried out.

Mr. Aiken's wide experience will undoubtedly prove a valuable asset in the affairs of the Shawmut Bank.



It Happens in the Best Regulated Families

By BRIGGS



-Courtesy of The New York Tribune

Bank Advertising Exchange

Those listed herewith are willing to exchange booklets, folders and other advertising matter issued by them. Subscribers can get on this list free of charge

Watch for New Names and Other Changes

A

Adams, F. R., Will County National Bank, Joliet, Ill.
American National Bank, Richmond, Va.
American Savings Bank, Springfield, Mo.
Ansley, D., c/o Central Trust Co., San Antonio, Tex.
Art, Carl W., manager publicity department, Union Trust Co., Spokane, Wash.

B

Bader, A. F., publicity manager, Old State National Bank, Evansville, Ind.
Bailey, C. W., cashier, Southern Trust Co., Clarksville, Tenn.
Bank of San Rafael, San Rafael, Cal.
Bankers Magazine, The, New York.
Bauder, Ray E., cashier, First National Bank, Taylorville, Ill.
Baughner, E. M., president, The Home Building Association Co., Newark, O.
Beerbower, C. W., National Exchange Bank, Roanoke, Va.
Bennett, H. D., assistant cashier, Capital National Bank, Lansing, Mich.
Bollman, H. C., assistant cashier, First National Bank, Collinsville, Okla.
Branham, D. R., 6252 Leland Way, Los Angeles, Cal.
Brannen, Jesse E., cashier, First National Bank, Westwood, N. J.
Brooks, T. J., cashier, The Guaranty Trust and Savings Bank, Jacksonville, Fla.
Brown, R. A., assistant cashier, Citizens National Bank, Raleigh, N. C.
Bunch, F. B., cashier, Merchants and Farmers Bank, Statesville, N. C.
Burton, E. C., vice-president, Penn. National Bank, Chester, Pa.
Burwell, Stephen L., vice-president, First National Bank, Jackson, Miss.
Bush, A., Jr., Ladd & Bush, bankers, Salem, Ore.

C

Citizens Bank and Trust Co., Tampa, Fla.
Citizens National Bank, Oconto, Wis.
Copp, R. Reed, assistant advertising manager, National City Bank, New York City.
Cory, Arthur S., Chehalis National Bank, Chehalis, Wash.
Craig, David, Tradesmen's National Bank, Philadelphia, Pa.
Critchell, L. S., publicity manager, Guaranty Trust Co., New York City.
Crowson, M. Clarence, cashier, Home Banking Co., High Point, N. C.
Culbreth, Eugene E., Commercial National Bank, Raleigh, N. C.
Currey, Bradley, c/o Fourth and First National Bank, Nashville, Tenn.

D

Dalby, H. A., Naugatuck Savings Bank, Naugatuck, Conn.
Davenport, C. M., manager new business department, Bank of Italy, Los Angeles, Cal.
Dexter Horton National Bank, Seattle, Wash.
Durham, T. R., assistant cashier, Chattanooga Savings Bank, Chattanooga, Tenn.
Dysart, W. R., assistant cashier, First National Bank, Ripon, Wis.

E

Eberspacher, J. C., assistant cashier, First National Bank, Shelbyville, Ill.
Eklirch, A. A., secretary, North Side Savings Bank, New York City.
Ellsworth, F. W., secretary, Guaranty Trust Co., New York City.

F

Finch, E. W., assistant cashier, Birmingham Trust and Savings Co., Birmingham, Ala.
First National Bank, Lead, S. D.
Franklin Society, 38 Park Row, New York City.
Frieden, Ben W., 324 Davidson Building, Sioux City, Iowa.

G

Gooden, B. P., Mercantile Bank of the Americas, New York City.
Groves, J. W., advertising manager, Northwestern National Bank, Minneapolis, Minn.

H

Hansher, C. F., First National Bank, Los Gatos, Cal.
Hann, Victor F., manager publicity department, The Fifth Avenue Bank, New York City.
Hardee, D. L., publicity manager, Wachovia Bank and Trust Co., Winston-Salem, N. C.
Harper, W. A., Lumberman's National Bank, Houston, Tex.
Hatton, E. A., cashier, First National Bank, Del Rio, Tex.
Hill, John R., Barnett National Bank, Jacksonville, Fla.
Hoagland, Jessamine G., publicity manager, National City Bank, Chicago, Ill.
Hokanson, N. M., State Bank of Chicago, Chicago, Ill.

J

Jarvis, Charles D., c/o Savings Bank of Utica, Utica, N. Y.
Jenkins, W. L., Farmers and Mechanics Trust Co., West Chester, Pa.
Jessup, Theodore, Woodlawn Trust and Savings Bank, 1204 E. 63rd Street, Chicago, Ill.
Jones, W. F., assistant cashier, First National Bank of Commerce, Hattiesburg, Miss.

Keep us in touch with your publicity work. Each month current advertising is reviewed and commented upon, ads are reproduced and criticised in **BANKING PUBLICITY**

K

Kahn, A. T., vice-president, Commercial National Bank, Shreveport, La.
 Kankakee County Trust and Savings Bank, Kankakee, Ill.
 Kay, W. R., Jr., advertising manager, Sacramento Bank, Sacramento, Cal.
 Keller, C. B., Jr., assistant cashier, Stroudsburg National Bank, Stroudsburg, Pa.
 Keyton, Grover, New Farley National Bank, Montgomery, Ala.
 Kittredge, E. H., advertising manager, Old Colony Trust Co., Boston, Mass.

L

Lanier, B. W., First National Bank, Lakeland, Fla.
 Lindhjem, A. E., assistant cashier, Scandinavian-American National Bank, Minneapolis, Minn.
 Logan, John, cashier, Columbus State Bank, Columbus, Mont.

M

McDowell, J. H., c/o American Trust and Banking Co., Chattanooga, Tenn.
 Mann, Ralph H., Park Trust Co., Worcester, Mass.
 Marvel, Charles S., The First-Second Savings and Trust Co., Akron, O.
 Matthews, Dave S., assistant cashier, Farmers and Merchants Bank, Stockton, Cal.
 Matthews, H. B., S. W. Straus & Co., Straus Building, Chicago, Ill.
 Merrill, Frank, advertising manager, The Northwestern National Bank, Minneapolis, Minn.
 Meyer, A. J., Union Trust Co., Rochester, N. Y.
 Mills, W. C., New Business Department, Metropolitan Trust Co., 60 Wall Street, New York City.
 Mulrhead, G. C., vice-president, The Stock Growers State Bank, Worland, Wyo

N

Northwestern Trust Co., R. P. Sherer, vice-president, St. Paul, Minn.
 Norton, W. W., treasurer, Robbins Burrall Trust Co., Lakeville, Conn.

O

Old State National Bank, Evansville, Ind.
 Overton, J. A., cashier, The National Bank of Smithtown Branch, Smithtown Branch, N. Y.

P

Parish, R. B., cashier, Bluefield Bank, Bluefield, W. Va.
 Poole, John, president, Federal National Bank, Washington, D. C.
 Potter, A. E., president, Broadway National Bank, Nashville, Tenn.

Potts, W. W., treasurer, The Federal Title and Trust Co., Beaver Falls, Pa.
 Publicity Department, St. Louis Union Bank, St. Louis, Mo.

R

Ruff, William J., cashier, Luzerne County National Bank, Wilkes-Barre, Pa.
 Russell, W. W., cashier, First National Bank, White River Junction, Vt.

S

Schlenker, Almot, assistant cashier, First National Bank, Brenham, Tex.
 Scott, Walker, vice-president, Virginia Trust Co., Richmond, Va.
 Shepherd, George W., c/o International Trust Co., Boston, Mass.
 Smith, A. C., vice-president, City National Bank, Clinton, Iowa.
 Smith, T. K., Jr., manager, Gimbel Brothers, bankers, New York City.
 Stephenson, J. E., Atlantic National Bank of Jacksonville, Jacksonville, Fla.
 Stewart, F. E., Chesborough Dwellings, Jefferson Avenue, Toledo, O.
 Stoner, T. H., cashier, The Peoples National Bank, Waynesboro, Pa.
 Stover, J. C., secretary-treasurer, Indiana Savings and Loan Association, South Bend, Ind.

T

Taylor, C. E., Jr., president, Wilmington Savings and Trust Co., Wilmington, N. C.

U

Union Trust Co. of D. C., Washington, D. C.

V

Van Blarcom, Wessels, assistant cashier, Second National Bank, Paterson, N. J.
 Van Name, Miss M. I., 515 Stephen Girard Building, Philadelphia, Pa.

W

Wadden, John W., Lake County Bank, Madison, S. D.
 Williams, F. H., assistant treasurer, Albany City Savings Institution, Albany, N. Y.
 Williams, J. E., assistant cashier, Third National Bank, Scranton, Pa.
 Wilson, C. C., c/o Continental and Commercial Trust and Savings Bank, Chicago, Ill.
 Withers, K. K., publicity manager, County Savings Bank, Scranton, Pa.

Z

Zimmerman, Frank A., Chambersburg Trust Co., Chambersburg, Pa.
 Zimmerman, Paul E., cashier, Oak Park Trust and Savings Bank, Oak Park, Ill.



Banking and Financial Notes

PROGRESSIVENESS IN ORDER AT THE CHEMICAL NATIONAL BANK

In a recent number **THE BANKERS MAGAZINE** announced the election of Percy H. Johnston as vice-president and director of the Chemical National Bank of New York. Mr. Johnston was formerly vice-president of the Citizens National Bank of Louisville, Kentucky, with which institution he was associated for about four years, first as cashier and later as vice-president. Previously he had served as the government's representative in charge of the national banks in the State of Kentucky and



HERBERT K. TWITCHELL
President Chemical National Bank, New York



The Branch
Our first President

Merchants National Bank

RICHMOND, VA.

Capital \$400,000
Surplus and Profits over 1,000,000

The Gateway to and Collection
Center for Southeastern States

Send Us Your Items

"ON TO RICHMOND"

later as chairman of the examiners of the Southern States, his territory lying south of the Ohio and east of the Mississippi rivers. He then was appointed one of the four national bank examiners and served in that capacity until 1913, when he became associated with the Citizens National Bank of Louisville.

Herbert K. Twitchell, whose banking career we have previously detailed, is president of the Chemical National Bank, which institution has almost a century of existence to its credit and a reputation unique in the history of American banking. Since 1911 Mr. Twitchell has served as vice-president and member of the board of directors of the Chemical National Bank until this year, when he became president.



The Chemical National Bank of New York

(Established 1824)

Capital, Surplus and Undivided Profits, \$11,000,000

A Bank Founded on a Successful Business

This Bank derives its name from the old New York Chemical Manufacturing Company which, in 1824, on the strength of its sound business principles, obtained a charter to do a general banking business.

The same conservative policies which at that time won for the Chemical Bank the respect and confidence of other financial institutions are responsible to-day for our wide clientele among banks and bankers.

Interest paid on balances of Banks, Time
Deposits, and Special and Reserve Accounts.

Correspondence solicited

H. K. Twitchell, President
Percy H. Johnston, Vice-President
Francis Haipin, Vice-President
I. B. Hopper, Vice-President
E. H. Smith, Cashier

James L. Parson, Assistant Cashier
J. G. Schmelzel, Assistant Cashier
John B. Dodd, Assistant Cashier
Samuel T. Jones, Assistant Cashier
H. M. Rogers, Mgr. Foreign Dept.

DIRECTORS

Frederic W. Stevens
W. Emlen Roosevelt
Robert Walton Goelet

Charles Cheney
Arthur Iselin
Frederic A. Julliard

Ridley Watts
Herbert K. Twitchell
Percy H. Johnston



PERCY H. JOHNSTON
Vice-President Chemical National Bank, New York

His experience with this and other banks and the addition of Mr. Johnston to the staff of officers and the board of directors give promise that the Chemical National Bank will keep abreast of the demands of the times while continuing to live up to its reputation for soundness and conservatism.

BANK CANNOT GIVE GOLD COINS

The American Exchange National Bank of New York has issued a letter to its customers stating that owing to the Treasury Department's decision the bank will be unable to give out gold coins for holiday use. The bank says:

The use of gold coins as holiday presents during the war period is being discouraged by the Government—not for the purpose of abolishing a time-honored custom, but, to put it plainly, to conserve its supply of gold and thus help win the war.

That a hearty and willing response from everyone will be forthcoming goes without saying.

It occurs to us that excellent substitutes can be found, through the use of Liberty Bonds, War Savings Certificates, and United

Kings County Trust Company

City of New York, Borough of Brooklyn

Capital \$500,000 Surplus \$2,000,000 Undivided Profits \$800,000

OFFICERS

JULIAN P. FAIRCHILD,
WILLIAM HARKNESS,
D. W. McWILLIAMS,
WILLIAM J. WASON, JR.,

JULIAN D. FAIRCHILD, *President*

Vice-Presidents

THOMAS BLAKE, *Secretary*
HOWARD D. JOOST, *Assistant Secretary*
J. NORMAN CARPENTER, *Trust Officer*
GEORGE V. BROWER, *Counsel*

ACCOUNTS INVITED.

INTEREST ALLOWED ON DEPOSITS.

States Thrift Cards. These should not only prove to be acceptable presents, but their use would encourage the further development of thrift—to the importance of which the people of this country are slowly awakening. "Easy to come, easy to go," as the saying is, can be safely applied to money presents. Why not introduce the investment feature into your Christmas gifts? You will serve three purposes:

The spirit of the holiday time will be gratified;

The necessity for saving and for thrift will be emphasized;

Your country will be backed in its fight for right.

H. R. KINSEY HEADS NEW YORK CHAPTER

Henry R. Kinsey, assistant comptroller of the Williamsburgh Savings Bank of Brooklyn, has been selected as president of New York Chapter of the American Institute of Banking, to succeed Mr. A. F. Maxwell, assistant cashier of the National Bank of Commerce, who resigned because of his appointment as southwestern representative of his institution, with headquarters at Dallas, Texas.

Mr. Kinsey's relations with the American Institute of Banking date back to the early days of the organization, when he was secretary of the old Brooklyn chapter, and later became second vice-president at the time of the consolidation of Brooklyn and New York Chapters. He was chairman of the Chapter's publicity committee two years ago, and is at present a member of the board of governors. For the last several years he has been the eastern member of the A. I. B. transportation committee, and in this office—like all

other matters that come under his care and responsibility—he has served with unusual credit, as can be amply attested by all the eastern delegates. A large



HENRY R. KINSEY

President New York Chapter A. I. B.; Assistant Comptroller Williamsburgh Savings Bank, Brooklyn, N. Y.

part of the success of New York Chapters' annual banquets in late years has been due to Mr. Kinsey's efficiency as treasurer of the entertainment committee.

No man could be found who would give more of the very best that is in him than will Mr. Kinsey, and New

"The Bank That Service Built"

THE
SEABOARD NATIONAL BANK
OF THE CITY OF NEW YORK

Capital \$1,000,000
Surplus and Profits (Earned) 3,424,026
Deposits 63,838,000

S. G. BAYNE, President

C. C. THOMPSON, Vice-President

B. L. GILL, Vice-President

W. K. CLEVERLEY, Vice-President

L. N. DeVAUSNEY, Vice-President

H. W. DONOVAN, Cashier

O. M. JEFFERDS, Asst. Cashier

C. C. FISHER, Asst. Cashier

J. D. SMITH, Asst. Cashier

B. I. DADSON, Asst. Cashier

J. E. ORR, Asst. Cashier

DIRECTORS

SAMUEL G. BAYNE

WILLIAM K. CLEVERLEY

EDWARD J. CORNISH

MICHAEL J. DEGNON

HENRY C. FOLGER

BENNETT L. GILL

EDW. H. R. GREEN

PETER McDONNELL

STUART G. NELSON

JOSEPH SEEP

CHARLES C. THOMPSON

WILLIAM H. WOODIN

The success of this bank is founded upon a policy of painstaking,
efficient and courteous service to all

ACCOUNTS INVITED

York Chapter is to be congratulated upon his selection as president.

WALDRON P. BELKNAP ELECTED VICE-PRESIDENT BANKERS TRUST COMPANY

Waldron P. Belknap, who has been doing special work in the trust department of the Bankers Trust Company, New York, has been elected a vice-president and will be one of the two vice-presidents in charge of the Astor Trust office.

Mr. Belknap has had wide experience in banking and trust business, and furthermore comes from a line of ancestors prominent in the financial history of New York. His great-grandfather, Henry Remsen, was cashier of the Manhattan Company in 1799, and later president; Robert Lenox, also a forbear, was a director of the United States Branch Bank in 1797, and in 1830 was one of the incorporators of the New York Life Insurance and Trust Company. Back in the '70's Mr. Belknap's

father, the late Robert Lenox Belknap, was a vice-president of the Mercantile Safe Deposit and Trust Company, the original incorporator of one of the institutions later merged with the Bankers Trust Company. An uncle two generations removed was James Lenox, founder of the Lenox Library and the Presbyterian hospital.

Mr. Belknap was born forty-four years ago in New York city. He is an alumnus of the Lawrenceville School and of Cornell University. In both school and college he was active in athletics, especially track work, in which he held interscholastic and college records.

From the time he left college until 1911 Mr. Belknap was connected in various capacities and finally manager of a department in the Title Guarantee and Trust Company, and in 1903 was made assistant secretary of the Bond and Mortgage Guarantee Company, which is closely affiliated. In 1908 he was elected president and a director,



100 YEARS OF COMMERCIAL BANKING

LOUIS G. KAUFMAN
President

FRANK J. HEANEY

Vice President

WILLIAM H. STRAWN

Vice President

NORBORNE P. GATLING

Vice President

H. A. CLINKUNBROOMER

Vice President

ROLFE E. BOLLING

Vice President

WALLACE T. PERKINS

Vice President

WALTER B. BOICE

Asst. Cashier

VINTON M. NORRIS

Asst. Cashier

RICHARD H. HIGGINS

Vice President

BERT L. HASKINS

Vice-Pres. and Cashier

C. STANLEY MITCHELL

Vice President

MAX MARKELL

Vice President

GEORGE R. BAKER

Vice President

HENRY L. CADMUS

Asst. Cashier

HENRY C. HOOLEY

Asst. Cashier

JOSEPH BROWN

Asst. Cashier

GEORGE M. HARD
Chairman

ACCOUNTS INVITED

Resources One Hundred and Three Million Dollars

having previously served as secretary. He was also a director of the New York Investors Corporation and of the City Real Estate Company. In 1911 he resigned from these affiliations to become a partner in the firm of Albert B. Ashforth, Inc., dealers in real estate. He continues as director of that company, and is also a trustee of the Dry Dock Savings Institution.

Mr. Belknap married a daughter of John H. Hutchings, of Hutchings, Sealy & Co., bankers of Galveston, Texas. He has one son, a sophomore at Harvard.

Mr. Belknap is treasurer and a trustee of the Presbyterian Church on University Place, and a manager and chairman of the finance committee of the American Bible Society. He is a member of the Society of the Cincinnati, of the Society of Colonial Wars, and of the Sons of the Revolution; of the Union. Racquet and Tennis, Garden City Golf, and Richmond County Country Clubs; of the Downtown Association, and of Psi Upsilon.

NOT IN VIOLATION OF SHERMAN LAW

Thomas B. Paton, general counsel of the American Bankers' Association, in

response to a request, has rendered an opinion that the campaign designed to induce various trade associations to pass resolutions recommending to their members to substitute trade acceptances for open book accounts is not in contravention of the Sherman Anti-Trust law. After examining the text of the resolution that associations will be asked to adopt, Mr. Paton said:

The substitution of trade acceptances for open accounts and the establishment of uniform and better terms of credit where goods are paid for with trade acceptances would, in my opinion, tend to promote rather than restrain interstate trade, and the result would be beneficial; but even were the contrary true, the effect of such an organized effort for change of methods would only have an indirect bearing upon interstate trade and commerce would not, in any event, be in violation of the act.

ADDITIONAL COMPENSATION TO GUARANTY EMPLOYEES

The Guaranty Trust Company of New York notified its employees Saturday that, in view of the present rise in the cost of living, from ten to thirty per cent. additional compensation will be given those now receiving salaries of \$3,000 a year and less. This extra

Service

The Citizens National Bank of New York for sixty-six years has specialized in accounts of merchants, and is located in the heart of the district where the largest part of New York's mercantile business is transacted.

We are thoroughly equipped to render the best of service to correspondent banks covering their requirements of every nature in New York.

THE CITIZENS NATIONAL BANK OF NEW YORK

Capital, Surplus and Undivided Profits \$5,000,000

EDWIN S. SCHENCK, President

FRANCIS M. BACON, JR., Vice-Pres.

ALBION K. CHAPMAN, Cashier

JAMES MCALLISTER, Asst. Cashier

GARRARD COMLY, Vice-Pres.

JESSE M. SMITH, Asst. Cashier

WILLIAM M. HAINES, Asst. Cashier

compensation will be allowed to those present employees who were in the employ of the company on July 2, 1917, and will be paid on a quarterly basis for the period of one year beginning November 1, 1917.

The percentages of these additions and their application to annual salaries are as follows: Up to \$600 inclusive, thirty per cent; \$601 to \$1,200 inclusive, twenty-five per cent; \$1,201 to \$1,800, inclusive, twenty per cent.; \$1,801 to \$2,400, inclusive, fifteen per cent.; \$2,401 to \$3,000, inclusive, ten per cent.

The Guaranty Trust Company has had in effect for some time a plan by which the salaries of certain classes of employees are automatically increased each year. This will not be affected, it is said, by this provision for additional compensation; neither will the annual bonus, should the company decide to declare one.

THE MOBILIZATION OF OUR BANKING RESOURCES

The officers and directors of the National Association of Credit Men, in annual meeting, adopted the following resolution:

The Federal Constitution, giving as it does, very wisely, certain powers to the several states, has resulted in the creation of forms of banking that are divergent from the plan of the national banking system, from which arise certain conditions that make centralized control and joint operation difficult though conditions suggest most urgently the desirability of such centralization.

"Therefore, the officers and directors of the National Association of Credit Men, in annual meeting, while appraising properly the reasons for independent action, yet feel that it were highly desirable as giving a better guarantee of the nation's welfare that the state banking institutions and trust companies operating commercial departments joined the Federal Reserve System and thus gave to the nation a centralized, flexible, well-controlled system of banking, for the effect would soon become apparent in increased powers of the nation to provide for



SAMUEL FERGUSON

President Philippine National Bank



CHARLES C. ROBINSON

New York Agent, Philippine National Bank

its financial requirements and to offer adequate facilities for the protection and development of our domestic commerce."

Here, as will be noted, the board expressed its firm belief that the time had arrived when the entire banking powers of the nation should be mobilized to form the strongest possible basis for the enormous credits which must be sought by the government in the form of war loans.

CHASE BANK GIVES DINNER

The Chase National Bank of New York recently gave a dinner to its officers, friends and employees. The dinner was given in honor of the Chase Bank Club at the Hotel Astor. Short speeches were made by A. Barton Hepburn, chairman of the board; Albert H. Wiggin, president, and Eugene V. R. Thayer, president-elect.

L. E. PIERSON ON WAR TIME FINANCES

Lewis E. Pierson, chairman of the board of the Irving National Bank of New York, on November 10 delivered an address on war time finances before the War Conference of Michigan's Business Men held at Detroit. Regarding government control of industry Mr. Pierson said:

Never before has a nation been burdened with such a weight of world business responsibilities. We must arm, equip, and maintain an immense and constantly increasing army of American soldiers, most of them are taken from fields of productive activity in which the need for them even in times of peace is urgent. We must build ships to transport them across the ocean at a time when destruction on the high seas lurks on every hand—we must send provisions sufficient to feed them and to feed other millions of soldiers fighting beside them in a common cause—we must furnish ships and machines and materials and food and clothing and medicines and money, and

WE ARE *helping our customers to meet the UNUSUAL demands of the present, and are assisting them in their plans for the future.*

ATLANTIC NATIONAL BANK

257 Broadway, New York

RESOURCES*



\$20,000,000

service to the nations with which we are associated in prosecuting the war—and all of this at a time when one demand plays against another, and when in all the world there is not a foreign market in which a dollar's worth of our securities can be utilized, nor in which our national credit, great though it be, is an asset upon which it is possible for us to realize. Verily, the business burden of the world has come to us in such a way as to try our capacity and our resourcefulness to the limit.

Confronted by such a stupendous task as this, there should be no doubt in the mind of either Government or individual as to their respective responsibilities, nor should there be any time wasted in discussing or treating any but matters directly related to the solution of the national problem in which both are so vitally interested. One important fact seems to have been definitely settled, and to the satisfaction of all concerned. The government is to exercise direction and control of the business of the nation during the period of the war.

WHY METROPOLITAN TRUST JOINED FEDERAL RESERVE

The October number of the *Metteo* Meteor, which is the monthly publication of the Metropolitan Trust Com-

pany of New York in the interest of its employees, contains an excellent article on why the bank joined the Federal Reserve System. The article is divided into seven distinct reasons or considerations as the bank calls them. The considerations are: Patriotism, banking policy, security, good-will, commercial expansion, and positive and negative considerations. The first reason advanced by the bank for joining is that of patriotism and with regard to this the article says:

The Metropolitan Trust Company recognizes the fact that the nation is at war, that the credit demands of the future will require all its credit strength, that the country cannot claim to have a strong and efficient banking system with one-half of its banks outside of the system without power to rediscount with the Federal Reserve Bank and still operating on the inelastic and decentralized basis of the past generation. The credit power of the country will be immensely strengthened if all the state banks will join the system. We believe we should do our part in this strengthening process at a time when it will add to the country's war and credit efficiency.

National Bank of Commerce in New York

PRESIDENT
JAMES S. ALEXANDER

VICE-PRESIDENTS
R. G. HUTCHINS, JR.
HERBERT P. HOWELL
J. HOWARD ARDREY
STEVENSON E. WARD
JOHN E. ROVENSKY
GUY EMERSON

CASHIER
FARIS R. RUSSELL



AUDITOR
A. F. JOHNSON

ASSISTANT CASHIERS

A. J. OXENHAM
WILLIAM M. ST. JOHN
LOUIS A. KEIDEL
A. F. MAXWELL
JOHN J. KEENAN
GASTON L. GHEGAN
A. F. BRODERICK
EVERETT E. RISLEY
H. P. BARRAND
R. W. SAUNDERS
H. W. SCHRADER
R. E. STACK

MANAGER FOREIGN DEPARTMENT
FRANZ MEYER

CAPITAL, SURPLUS AND UNDIVIDED PROFITS OVER \$45,000,000

COMMENTS ON WAR SAVINGS CERTIFICATES

The Mechanics and Metals National Bank of New York in its November 15 financial letter speaks of the war savings certificates plan as follows:

It is hardly to be expected that there will be another formal long-term bond offering by the government until well along in next year. War needs are taken care of for a number of months ahead by the second Liberty Loan, and by the taxes that have been imposed by Congress. Beyond the income from these sources, there is the plan, shortly to be launched, by which the public may purchase so-called War Savings Certificates. Authorized up to an amount of two billion dollars, we understand these certificates are to be offered broadcast at a price of \$4.12. To make them especially attractive to the great army of the working classes, the certificates will have a maturity of five years and a redemption price of \$5, which sum is equivalent to the original investment with four per cent. compound interest. Investors will purchase 'savings stamps' and 'thrift stamps,' fastening them to cards which ultimately will be redeemed by the government.

The idea is to establish war savings clubs from one end of the country to the other, so that there may be a stream of capital constantly flowing into the treasury, thereby avoiding to a large extent the interim borrowings from the banks for short periods, and the engaging in frequent great operations for single war loans, with a definite term fixed for subscription. By making the sale of these certificates continuous, it is believed the raising of war funds will proceed all the more effectively, because it will be carried forward unobtrusively yet with emphasis upon loyal cooperation all along the line.

BANKERS TRUST CO. ELECTS NEW DIRECTORS

Two new directors, Allen B. Forbes of Harris Forbes & Co., and O. D. Young, vice-president of the General Electric Company, were elected at a recent meeting of the board of directors of the Bankers Trust Company, New York. B. A. Tompkins was appointed first assistant secretary.

MCLANE TILTON, JR. TO REPRESENT CHEMICAL NATIONAL BANK IN SOUTH

Mr. McLane Tilton, Jr., president of the First National Bank, Pell City, Alabama, was appointed November 1 as Southern Representative of the Chemical National Bank of New York.

Mr. Tilton is a graduate of the University of Virginia and of the University of Michigan Law School. He comes from a prominent Southern family and has wide acquaintances and connections in the South. For ten years he was secretary of the Alabama Bankers Association, never had an opposition candidate, and resigned between convention dates to prevent reelection. He served a term on the executive council of the American Bankers Association and came within one vote of being elected its treasurer. He served as president of the Alabama State Press Association, also as vice-president of the Alabama Bar Association. On nu-

merous occasions he has been on the program for addresses at various Southern bankers' conventions. He is one of the best-known men in the South.

F. H. SISSON ON COMMERCIAL FORESIGHT

Francis H. Sisson, vice-president of the Guaranty Trust Company of New York, in a recent address delivered before the National Association of Cotton Manufacturers at Springfield, Massachusetts, said:

We are merely on the threshold of the great period of expansion lying before us. And a premium such as never before existed has been placed on commercial foresight. This result is more pronounced in no business than that of the cotton manufacturer, which you represent.

Cotton fibre is interwoven with civilization, and the snapping of that slender white thread would break the network of international trade.

The war has created a general and unequalled prosperity in this country. Cotton manufacturers have been kept so busy supplying present needs that they have had little time to look beyond their immediate horizon. As some one has aptly remarked, "the breath of war has puffed cotton into the air like thistledown." But we should not forget that when Mars, the world's greatest consumer, ceases to buy the reaction is bound to be felt, directly or indirectly, by every one of the nearly thirty-three million spindles in the United States. There probably will be no immediate lessening of the demand for the products of the mills; indeed, it is likely that there will be a greater demand. The addition of a single pound per capita to the world's consumption, however, would increase the need for cotton, one authority has computed, by more than four million bales. So, it is manifest that there will be sharp readjustments. This will be true of all our industries and businesses. For beyond "No Man's Land" lies Every Man's Ground—world organization and public control, which will not be restricted by national boundaries or interests."

PRIVATE WORK MUST BE LIMITED

The National City Bank of New York in a recent review of economic and financial conditions speaks as regards private industry as follows:

The real problem is, how fast will the program adopted by the government require disbursement to be made? Figures have been given in the newspapers ranging from \$14,000,000,000 to \$19,000,000,000, as the

Resources

\$17,000,000.00

If intelligent handling of items and low rates appeal to you send us your Buffalo business



**Try our Service
and you will be entirely
satisfied**

A. D. BISSELL, President
C. R. HUNTLEY, Vice-Pres.
E. H. HUTCHINSON, Vice-Pres.
E. J. NEWELL, Vice-Pres.
HOWARD BISSELL, Cashier
C. G. FEIL, Asst. Cashier
A. J. ALLARD, Asst. Cashier
G. H. BANGERT, Asst. Cashier

Citizens Commercial Trust Company

BUFFALO, N. Y.

GROWTH IN DEPOSITS

Sept. 20, 1916, .	\$7,484,024.47	June 20, 1917, .	\$13,624,155.57
Nov. 29, 1916, .	10,159,088.53	Sept. 8, 1917, .	14,804,336.56
Feb. 28, 1917, .	10,814,812.66	NOV. 14, 1917, .	16,203,785.32

MEMBER FEDERAL RESERVE SYSTEM

amounts required during this fiscal year. It is evidently difficult to make a close estimate upon enormous operations, involving so much work that is out of the ordinary run. On the face of the proposition it looks impossible to expend that amount of money for the purposes in view, within the time stated.

If \$18,000,000,000 or \$20,000,000,000 are to be expended upon government work it is certain that private work must be more drastically curtailed. The available supply of labor is limited, and competition for it increases costs without increasing product. The payment of extraordinary wages will attract labor to the war industries, but if it is drawn from coal mines, railways and farms the situation may be so disorganized that even war work will be impeded. The situation is most effectually handled by having the government exercise priority rights. It is doing this as to materials and equipment, and may have to go farther and exercise a priority right to labor. If conscription for government work is deemed impracticable, the object may be accomplished by restricting the employment of labor in non-essential industries.

COMMENTS ON WAR EXPENDITURES

Knauth, Nachod and Kuhne, in their last financial letter comment on the war expenditures of our government as follows:

Although the war outlays are prodigious and the taxation provided without precedent, it must be remembered that every dollar spent by the federal government for its own account and for that of its allies is being expended within our own borders. This means that while the war represents a frightful waste, the outlays that must be made, in order to make American participation effective, really help American industry. This government is not purchasing its supplies abroad, it is not exporting gold to any great extent and it is not obliged to

import its foodstuffs, or to pay tribute to other markets.

BOOKLET ON COST OF WAR

The Mechanics and Metals National Bank of New York has issued a very valuable booklet on the cost of war. This booklet not only gives the money cost but also the human cost and is one of the few good booklets of its kind.

J. P. MORGAN'S EMPLOYEES SUBSCRIBE

Every employee of J. P. Morgan & Co. has subscribed to the Liberty Loan. The firm has fifty-five men now in the service of the army and navy and these men, too, have informed the firm that they have subscribed.

THE BALANCE SHEET OF THE NATIONS AT WAR

Under this title the Bankers Trust Company of New York City has published a most interesting sixteen-page pamphlet. The nations of the world are grouped in accordance with their affiliations in the present world war. A comparison is instituted as to the relative standing of each group in regard to area, population, fighting strength, wealth and debt, income and interest charges, and in war costs to date in money and in men.

A map of the world on Mercator's projection, colored to represent the affiliations, is a valuable feature of the book.

The fact is pointed out that in practically every respect except that of



EQUIPPED FOR SERVICE

Located in a modern building with every facility for the efficient handling of its business, this bank is in a position to offer you prompt and adequate service in your Philadelphia banking transactions.

**UNION
NATIONAL
BANK**



PHILADELPHIA
Resources over
\$13,000,000

original "preparedness" the Entente Allies hold a superior position to that of the Teutonic Allies. The conclusion is drawn, therefore, that the war was deliberately forced by Germany to further her ambitious designs for world domination.

The book was published by the Bankers Trust Company for free distribution as a part of its contribution to the success of the Liberty Loan. Copies may be had on application at either of the company's offices.

BANK DECLARES LIBERTY LOAN DIVIDEND

At a recent meeting of the directors of the American Exchange National Bank of New York a semi-annual dividend of five per cent., and in addition, an extra dividend of one per cent. payable in Liberty Loan bonds, was declared on the capital stock.

REPORTS SOUTH AMERICAN TRADE

The National City Bank of New York has recently issued a compilation show-

ing that trade with South America is three times as great as the year before the war.

The total exports to that continent in the eight months ended with August aggregated \$188,000,000, against \$65,000,000 in the corresponding months of 1914, and the imports were \$433,000,000, against \$157,000,000 in the same months of 1914. Thus the total trade was \$620,000,000, against \$222,000,000. Merchandise from the United States formed about thirty per cent. of the imports of all South America in 1916, while in 1913 we supplied but fifteen per cent. of the total imports of that continent. Manufactures form over ninety per cent. of our exports to South America, and in practically all of these the increase is strongly marked.

WILL JOIN FEDERAL RESERVE

The United States Mortgage and Trust Company, the Bank of the Manhattan Company, the Brooklyn Trust Company and the Scandinavian Trust Company, all of New York, have made application for membership in the Federal Reserve System.



At the Gateway to the Great Southwest

The National Bank of Commerce IN ST. LOUIS

offers its services for the prompt and dependable handling of your banking business in this section of the country

Capital, Surplus and Profits, over \$13,000,000.00

*“Large enough to serve any—
Strong enough to protect all”*

TOM RANDOLPH, Chairman of the Board

JOHN G. LONSDALE, President

W. L. McDONALD, Vice-President

W. B. COWEN, Vice-President

J. A. LEWIS, Vice-President and Cashier

WILLIAM H. KNIFFEN, VICE-PRESIDENT
AND MANAGER, BANK OF ROCKVILLE
CENTRE

William H. Kniffin, Jr., vice-president of the First National Bank of Jamaica, Long Island, has tendered his resignation to become the vice-president and manager of the Bank of Rockville Centre, N. Y. Mr. Kniffin began his banking career as a clerk in the Rondout Savings Bank at Kingston, N. Y., and was later cashier of the Home Savings Bank of Brooklyn, and treasurer of the Onondaga County Savings Bank of Syracuse. He was at one time secretary of the Savings Bank section of the American Bankers Association, and is the author of several well-known books on banking, and is at present editor of the law department of THE BANKERS MAGAZINE, and lecturer on banking practice in New York University.

Warren B. Ashmead has been elected to fill Mr. Kniffin's place. Richard Van Sicken, cashier of the First National Bank of Jamaica, has been appointed

first vice-president and William Peterson, assistant cashier, has been elected cashier to succeed Mr. Van Sicken.

THE COLONIAL BANK

At the 159th half-yearly general meeting of the directors of the Colonial Bank, held at the bank house, Bishopsgate, London, the usual statement of accounts was submitted, showing total assets of £6,748,525, with deposits and current accounts of £4,169,986. The profit and loss account showed gross profits after providing for bad and doubtful debts of £103,554, and a balance was brought forward after payment of expenses, of £49,832.

Announcement was made of the opening of offices at Lucea, Jamaica; Speightstown, Barbadoes; Scarborough, Tobago, and one will shortly be opened at Savanna La Mar, Jamaica. In West Africa branches have been opened at Kano, Port Harcourt and Jos (Nigeria), Secondee (Gold Coast),

The
National Shawmut Bank
of Boston
Foreign Banking



Capital . . . \$10,000,000
Surplus . . . 5,000,000
Undivided Profits 3,900,000

Complete service to banks throughout the country in all branches of Domestic and Foreign business.
Commercial and Travelers' Letters of Credit; Collection of Foreign Drafts. Foreign Exchange and Cable Transfers purchased and sold.

CORRESPONDENCE INVITED

and Freetown (Sierra Leone). Messrs. Gilbert W. Fox of Messrs. Edward Grey & Co. and director of Lever Bros., Ltd., Liverpool, and Hugo Cunliffe-Owen, deputy chairman of the British American Tobacco Co., have been appointed directors.

A. B. A. APPOINTS COMMITTEE OF FIVE

The American Bankers Association has a committee of five appointed by President Hinsch to study the problem of clearings and collections.

The members of the committee are: Thos. B. McAdams, chairman, vice-president Merchants National Bank, Richmond, Virginia; Fred Collins, cashier Milan Banking Company, Milan, Tennessee; M. J. Dowling, president Olivia State Bank, Olivia, Minnesota; George G. Moore, cashier New England National Bank, Kansas City, Missouri; W. D. Vincent, vice-president Old National Bank, Spokane, Washington.

BANK OF BUFFALO

At a meeting of the board of directors of the Bank of Buffalo, held on Tuesday, November 13, Mr. Ralph Croy was elected director and vice-president, Mr. August J. Duerr was appointed assistant cashier, and Mr. T. B. F. Olsen manager of the bond department.

Both Mr. Croy and Mr. Duerr have been with the bank for a number of years. Mr. Olsen was formerly associated with Rhoades & Co., investment brokers, of New York.

The official staff of the Bank of Buffalo is now as follows:

Elliott C. McDougal, president; Robert K. Root, vice-president; Ralph Croy, vice-president; T. B. F. Olsen, manager bond department; John L. Daniels, cashier; Louis C. Olden, Charles D. Appleby and August J. Duerr, assistant cashiers.

The Bank of Buffalo now occupies its new building, and the prosperity which the institution has attained is evidenced

The ^{B/L}
Collection Bank
of Chicago



We have a special proposition for any bank or corporation handling bill of lading drafts on Chicago and Eastern points.

UNION TRUST COMPANY
Chicago

Strictly a Commercial Bank
Member of the Federal Reserve System
Established 1869

The National Stock Yards National Bank AND The National Cattle Loan Company

ST. LOUIS NATIONAL STOCK YARDS, ILLS.

Are the largest cattle financing institution in the Eighth Federal Reserve District

WIET WRIGHT
President

O. J. SULLIVAN
Vice-President

ROBERT D. GARVIN
Cashier

by the fact that the total resources have increased to over \$28,000,000.

SPEAKS FOR FEDERAL RESERVE BRANCH IN BUFFALO

Elliott C. McDougal of the Bank of Buffalo, Buffalo, N. Y., recently spoke in favor of a branch of the Federal Reserve Bank being located in Buffalo. Mr. McDougal said:

The reserve banks have authority to open branches, but the New York institution has not seen fit to do so yet. Clearly a branch should be established in Buffalo to take care of the enormous business of the western half of the New York reserve district.

Buffalo has many banks which would be very important banks if they were in New York city itself; there are not many more important in the Greater City. I believe we can secure the branch bank here by insistently demanding it.

With the branch bank in Buffalo the local banks could send across the street and

get the supply they need of Federal Reserve currency. At present we have to order it from New York and then wait a couple of days for it.

The Buffalo banks at present have to mail or otherwise send their deposits to the bank in New York. With a branch here the bankers could send their deposits by messenger. A day would be saved each way on transmission.

MAKING A BUSINESS OF WAR

The Corn Exchange National Bank of Philadelphia has a good editorial on making war a business in its November house organ. The article outlines the situation which is before the country today, and then says:

Facing calmly and without fear this serious situation, it becomes the business of every business man to make, as his primary occupation, every hour of every day, the winning of this great world war. This is no time for planning campaigns along ordinary lines to win ordinary, or extraordinary,

SEND YOUR BUSINESS

ON THE

Twin Cities AND THE Northwest

TO THE

CAPITAL AND SURPLUS
TEN MILLION DOLLARS

We are prepared to meet your most exacting requirements and cordially invite you to write to us



Is It Not Sound Policy

to send your Baltimore business to the bank whose half century of experience gives assurance of efficiency and strength?

For the handling of collections and all other banking business, this institution is admirably equipped.

Large capital, surplus and resources enable this bank to offer you complete banking facilities and services which are real and not visionary.

The National Exchange Bank Baltimore, Md.

Capital & Surplus, \$2,480,000 Resources, \$12,048,000

WALDO NEWCOMER, President

SUMMERFIELD BALDWIN, Vice-Pres.

CLINTON G. MORGAN, Cashier

JOSEPH W. LEFFLER, Asst. Cash.

WILLIAM E. WEBB, Asst. Cash.

profits, to win a temporary or a permanent advantage over a trade rival. It is a time when every man with a stake in the country should remember Andrew Carnegie's advice: "Put all your eggs in one basket and then watch the basket." Under stress of circumstances we have been forced to put all our eggs into one basket. All our prospects of future success in every line of activity, in every profession or occupation, are at stake in this war for the right to live and labor under conditions foreshadowed by our Declaration of Independence and safeguarded by our Constitution.

It is a time for a truce of God in local or national commercial antagonisms, for a forgetting of old feuds, a discarding of all old antagonisms—a time for a truce of God throughout the length and breadth of this land in all economic or social warfare, for the hope of the world is between the fighting lines, and only a united, aggressive and patriotically inspired America can win quickly that victory which shall insure peace and prosperity to coming generations.

COMMENTS ON SECURITY SITUATION

The November 15 business and financial letter of the First National Bank of Philadelphia in commenting on the security situation says:

Continued liquidation in the securities markets has depressed the average price of various high-grade stocks to the lowest level touched since 1900. The decline in bond prices also has been quite as important. There have been various theories put forth to account for the heavy selling which, in the last analysis, represents the inevitable readjustment of security values to a basis more in conformity with the income return of the higher grade government bonds. It is recognized also that, inasmuch as this government has entered upon a long period of war financing with the probable announcement of fresh loans every few months, there must be constant shifting of other security holdings in the hands of investors who desire to subscribe for the successive liberty loans. Since the European war began in 1914, there have been only two issues, aggregating \$25,000,000 of new railroad stocks.

BANK REPORTS GENERAL CONDITIONS

The November digest of trade conditions issued by the Franklin National Bank of Philadelphia, reports the general business situation as follows:

The general slowing up and steadying of business transactions was evidenced during

September in a smaller number of new incorporations, a decrease in corporate financing, contracting building operations, a lessening in pig iron production, a decline in the unfilled tonnage of the steel corporation, a much smaller copper production, smaller anthracite shipments, smaller coke shipments, an increase in stocks of crude petroleum, and numerous other prime factors. That these declines do not indicate unfavorable business contraction is proved by increased bank clearings, decreased business failures, heavier foreign trade, larger stock and bond sales, increasing railway equipment orders, larger railroad gross earnings, a more serious shortage of freight cars, a heavier production of petroleum, and an increasing movement of grain.

NEW CASHIER OF PHILADELPHIA NATIONAL BANK

O. Howard Wolfe, heretofore assistant cashier of the Philadelphia National Bank, has been elected cashier of that institution, to succeed Horace Fortescue, who has been acting both as vice-



O. HOWARD WOLFE
Newly elected Cashier of the Philadelphia National Bank, Philadelphia, Pa.

president and cashier, but who will hereafter be vice-president only.

Mr. Wolfe is well known in banking circles. He became associated with the Philadelphia National in 1899, but left the bank to become secretary of the Clearing-House Section of the American Bankers Association. In this capacity he developed great energy and became an authority on clearing-house matters. He resigned this position to return to the Philadelphia National Bank as assistant cashier.

PHILADELPHIA BANK DIVIDENDS

The Girard National declared a semi-annual dividend of eight per cent., Franklin National ten per cent. for the same period and the Market Street National four per cent. The Third National declared six per cent. for the half year.

The Penn National Bank of Philadelphia has increased its dividend from seven per cent. to eight per cent. semi-annually, placing the stock on a sixteen per cent. basis.

ADDRESSES PHILADELPHIA A. I. B.

Charles P. Blinn, Jr., addressed the November meeting of the Philadelphia Chapter American Institute of Banking on the subject of war financing by belligerent nations.

CONDITIONS IN PITTSBURGH DISTRICT

The fact that trade in the Pittsburgh district is slackening is brought out by the Peoples National Bank of Pittsburgh in its November business and financial review. The bank reports:

The volume of current commercial business is somewhat below the maximum of the year, and it will not be surprising if the contraction extends to retail lines. According to figures compiled for the bank from sources which are believed to be trustworthy, the pig iron output of the district is below seventy per cent. of capacity, against ninety-seven per cent. at this time last year; total steel production is below ninety per cent., against ninety-six; coal production seventy-five, against sixty-three a year ago, and coke seventy-one, against

Converting Deposits Into Reserve

is the present day test of your ability to turn a losing account into one of profit.

The best collection system is the one that converts out-of-town checks into available cash in the shortest time.

The transit department of this bank receives and despatches mail 24 hours each day.

Send for our booklet

**“The Transfer of Reserves
To Federal Reserve Banks”**

THE

Philadelphia National Bank

(ORGANIZED 1863)

eighty-five. Railroad equipment building is about seventy-five per cent., against ninety-five in October, 1916. Building operations are below thirty per cent., which compares with about sixty per cent. a year ago. It is estimated that labor payrolls are seventy-five per cent. of normal, against eighty-eight per cent. a year ago. Despite higher costs of merchandise, it is estimated that the volume of retail mercantile trade is seven per cent. below the average for the first half of the year, and probably ten per cent. under the maximum of the year to date.

TREASURY DEPARTMENT EXPLAINS WAR SAVINGS PLAN

The Treasury Department of the government has sent out a circular summarizing the war savings plan. In short it is as follows:

The plan puts it easily in reach of every American citizen to save money and at the same time aid the government by supplying it with the sinews of war.

Stamps, which are the government's certificates of indebtedness, are to be sold in two denominations—thrift stamps, which cost 25 cents each, and war-savings stamps,

which cost from \$4.12 to \$4.23 each according to the month in which they are purchased.

With the first thrift stamp the purchaser is given a thrift card with spaces for sixteen stamps. When sixteen thrift stamps have been purchased and affixed the thrift card can be exchanged for a war-saving stamp by paying the difference between the \$4 the thrift stamps represent and the current value of a war-savings stamp, which in December, 1917, and January, 1918, will be \$4.12, and thereafter 1 cent for each succeeding month during the year 1918.

With the first war-savings stamps obtained by purchase or exchange the owner is given a war-savings certificate containing spaces for twenty war-savings stamps. If the twenty spaces are filled during December, 1917, or January, 1918, the cost to the purchaser will be \$4.12 for each stamp, or \$82.40 for the full certificate, and on the 1st day of January, 1923, the government will redeem the certificate at \$100, giving the holder a net profit of \$17.60 for the use of his money.

Although these investments do not mature until January 1, 1923, provision is made whereby upon ten days' written notice after January 1, 1918, such certificates will be redeemed by postmasters at their cost to the purchasers plus 1 cent a month on each war-savings stamp on the certificate.

Established
1857



60 Years of Con-
servative Banking

The
**Mechanics-American
National Bank**
of St. Louis

Capital, \$2,000,000
Surplus, \$2,500,000 Resources, \$39,233,000

▲ STRONG BANK WITH THE EQUIPMENT, THE EXPERIENCE AND
THE STRENGTH TO GIVE THE BEST SERVICE

ACCOUNTS INVITED

WALKER HILL, President

FRANK O. HICKS . . . Vice-President
JACKSON JOHNSON . . . Vice-President
EPHRON CATLIN . . . Vice-President
JOSEPH S. CALFEE Cashier

CHARLES L. ALLEN . . . Asst. Cashier
JAMES R. LEAVELL . . . Asst. Cashier
C. H. CHASE Asst. Cashier
RICHARD L. KING . . . Asst. Cashier

The thrift stamps do not bear interest, but the war-savings stamps bear four per cent., compounded quarterly. The certificates will be dated January 2, 1918, and mature January 1, 1923.

Under the plan an amount as small as 25 cents can be invested in a government security, and as soon as \$4 has been thus invested an interest-bearing certificate of the United States Government can be secured.

The stamps and certificates can be obtained from post offices, banks, or trust companies, at most railroad stations, stores, factories, and many other public places.

Having the entire wealth of the United States back of them, and being redeemable as above stated, there is no danger of any depreciation in value of the certificates.

RAILROADS' TASK DURING WINTER

The November 16 number of the "Railroads' War Board," which is the publication of the American Railway Association, contains a fine article by Fairfax Harrison, chairman of the "Railroads' War Board," on the task which the railroads of the United States now face. Mr. Harrison says:

During the coming winter, the railroads of the United States will face the greatest transportation problem in their history.

The war has created demands that have increased the railroads' burden virtually overnight by millions of tons of freight.

Some conception of what this increase means may be gleaned from the fact that the additional service which is being demanded of the railroads this year, is equivalent to carrying 120 billion tons of freight one mile. This increase alone is more than the combined freight traffic for one year of Great Britain, France, Austria, Russia and Germany.

Moreover, the railroads will have to handle it with facilities that, frankly speaking, are inadequate. Cars, locomotives, terminals and all the other equipment and track space that is needed to handle the increased freight traffic that a war almost simultaneously produces, cannot be built overnight.

To make the situation more difficult, practically all the steel which can be spared for the construction of locomotives and cars has been appropriated for use abroad either by the United States or by our allies. As a result, the railroads of the United States must face their task with practically no increase in equipment.

St. Louis and the Southwest—

The Mississippi Valley Trust Company has grown because St. Louis grew. It has developed because the great Southwest developed. It has prospered because its customers prospered.

Its seven complete departments—Financial, Trust, Bond, Real Estate, Safe Deposit, Savings and Farm Loan—are at your service.

Correspondence Invited

Mississippi Valley Trust Co.

Member Federal Reserve System

Capital, Surplus and Profits over \$8,000,000

ST. LOUIS

MISSOURI

J. D. BRENNAN BECOMES VICE-PRESIDENT

James D. Brennan has been elected a vice-president of the First National Bank of Boston. The bank has also appointed two new assistant cashiers, W. F. Benkiser and A. M. Horne.

BOSTON BANK ON LOCAL COAL CONDITIONS

Referring to the acute coal situation in the Boston district, the First National Bank of Boston in its last business and financial letter states:

New England normally carries two-thirds of its soft coal by water and one-third by rail. On account of the war, many of the coal-carrying barges have gone off the coast, and these cannot be replaced. The railroads cannot assume any added burdens and, in fact, their carrying capacity will undoubtedly be diminished twenty-five per cent. by winter storms and cold weather, which will also affect water transportation. New England's coal problem is, therefore, quite as much one of transportation as of securing the coal. Barge transportation from New York to Boston has increased from 50 cents a ton to as high as \$3 a ton,

and from Newport News, soft coal is paying \$3.50 to \$4 per net ton instead of the normal of 70 to 90 cents to New England. It is quite evident that the situation, so far as bituminous is concerned, is very critical.

BUENOS AIRES BRANCH

The name of the First National Bank of Boston is now becoming familiar to the people of Buenos Aires, where a branch has been opened under the di-



Buenos Aires Branch, First National Bank of Boston

**Increase
Your Deposits!**

**Distribute
BULLET
BANKS
Among Your
Depositors**

**Create New Ac-
counts Thru the
Use of this Safe.**

**FREE
SAMPLE**
on request
to Officials of Bank-
ing Institutions.
*Write us for particu-
lars.*

**Be First in Your
City to Use This
Bank.**

**Stronghart
Company**
1510 S. Wabash Ave.
Chicago

for this is the fact that farmers of this country have never been investors in bonds, while in Europe before the war almost every farmer owned a government bond. This is a great weakness in our present situation.

Our tax bill was so drawn as to bear very lightly on the farmer, so that a very large proportion of our population and wealth is comparatively free from war taxes. Farmers, however, are now subscribing liberally for bonds. In Cornell Township, Wisconsin, a farming community, every registered voter has subscribed.

**ADDITION TO STAFF OF UNION NATIONAL
BANK**

Hugh Wood and J. F. Fowler have been added to the staff of officers of the Union National Bank of Houston, Texas. At a recent meeting of the board of directors they were appointed assistant cashiers. A. L. Bowers is a newly elected director.

J. B. FORGAN ON Y. M. C. A. FUND

James B. Forgan, chairman of the board, First National Bank of Chicago and chairman of the ways and means committee of the Y. M. C. A. War Fund, which is in charge of the local campaign to raise \$3,000,000, has issued the following statement:

When the people of Chicago and the nation come to understand the significance of this campaign I feel that they will subscribe generously and enthusiastically. When they come to understand that the Y. M. C. A. is actually the big brother division of the United States Army, and is doing work that is essential to American glory and victory, they will loosen their purses from ocean to ocean. We ask \$3,000,000 from Chicago, which is a small sum, all things considered.

H. E. BYRAM BECOMES DIRECTOR

H. E. Bryam, president of the Chicago, Milwaukee and St. Paul Railroad, has been elected a director of the Continental and Commercial National Bank of Chicago.

**HARRIS TRUST AND SAVINGS BANK JOINS
FEDERAL RESERVE SYSTEM**

The board of directors of the Harris Trust and Savings Bank, Chicago, at a meeting, November 14th, voted unani-

rection of Vice-president F. A. Goodhue. As shown in the accompanying picture, the bank occupies a prominent corner building, which is close to the financial centre of the Argentinian metropolis.

ESSEX TRUST CO., LYNN, MASS.

Arthur W. Ingalls has been appointed assistant to President Micajah P. Clough of the Essex Trust Co., Lynn, Mass.

CHICAGO BANKER ON WAR FINANCE

E. D. Hulbert, president of the Merchants Loan and Trust Company of Chicago, recently delivered an address on the question of war finance. Mr. Hulbert said:

It is an unfortunate fact that the people of this country as a whole are not bond buyers as they are in Europe. One reason

mously to authorize the bank's officers to apply for membership in the Federal Reserve banking system.

In commenting on this action, Albert W. Harris, president of the bank, said:

"It was the unanimous opinion of our board of directors that this institution should do all in its power to help the Government finance the war. The officers of the Federal Reserve Bank have stated that they wished all the larger state banks to join the system in order to make the system strong enough to withstand any emergency and we have taken the above action purely on this account, because as we are not a commercial bank we cannot take very much advantage of the privileges of rediscounting commercial paper.

"We agree with the officers of the Federal Reserve System in believing that if a majority of the larger State Banks will join the system, it will place it in such a strong position that it will be able to successfully handle any financing which the country will be called upon to do.

"After the war is over, some of the state banks may decide to withdraw from the system in case they find it incompatible with the best interests of their business. However, while this bank is 'enlisting for the war' and hopes that a great many of the banks will do the same, we may find that we can afford to continue our membership after the war is over."

CRITICIZES THE AMERICAN FARMER

E. D. Hulbert, president of the Merchants Loan and Trust Company of Chicago, recently attacked the American farmers. Mr. Hulbert said:

The one weak spot in our existing situation is in the attitude of farmers. They will neither buy liberty bonds, pay taxes, sell their produce nor fight. I have asked many out-of-town bankers who have called here about farmers paying taxes, and I have learned of but one instance in which a farmer has paid an income tax. They have profited throughout the entire period of the war, but are unwilling to help the government in any of the four ways mentioned.

The Comptroller of the Currency has esti-

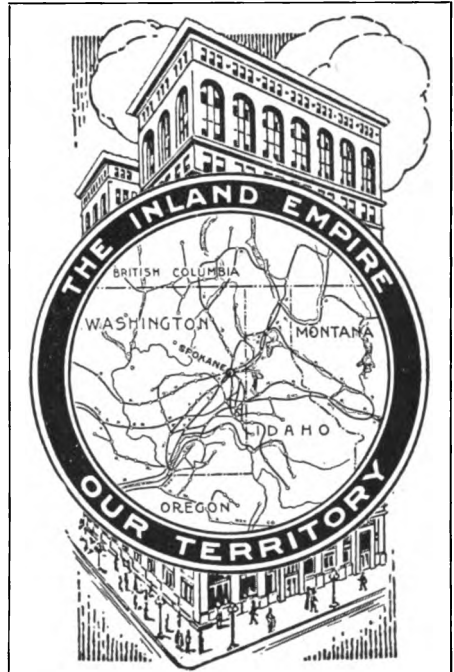

The Old National Bank of Spokane

WITH direct connections in every banking point throughout the "Inland Empire"—a region three times the size of Alabama, of which Spokane is the financial and railroad center—The Old National has the facilities to collect your Pacific Northwest items with exceptional economy and dispatch.

OFFICERS

- D. W. TWOHY, *President*
- T. J. HUMBIED, *Vice-President*
- W. D. VINCENT, *Vice-President*
- J. A. YEOMANS, *Cashier*
- W. J. SMITHSON
- G. H. GREENWOOD J. W. BRADLEY
- Assistant Cashiers*

RESOURCES : \$20,000,000

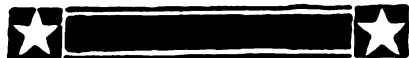

HARRIS, FORBES & CO

Successors to N. W. HARRIS & CO. New York

Pine Street, Corner William
NEW YORK

BONDS FOR INVESTMENT

In These War Times

Bankers, generally, are keenly alive to the urgency for intensive, stimulating effort, so that every dollar in the country shall "do it's bit."

WE CAN INCREASE YOUR DEPOSITS

Bring out the inactive money—develop the dormant accounts.

RESULTS — OR NO PAY

The Bankers Service Corporation

258 Broadway, New York City

mated the gross income of the United States to be about \$40,000,000,000. Of this he estimates farm produce and animals to bring a gross return of about \$17,000,000,000. The farmers according to this estimate are getting forty-two and one-half per cent. of the country's income and giving nothing out of it. It is left for the government to raise taxes and sell the bonds to the remaining fifty-seven and one-half per cent. while the class which as a whole has profited most escapes any burden.

The farmer has been pampered by politicians until he seems to feel he is in a preferred class, and, as I said, he doesn't want to buy liberty bonds, he doesn't want to fight, and he avoids his income tax. It is about time the farmer should appreciate the position in the country and help do his part in a war as much for his benefit as for those who are putting up the money and doing the fighting for him.

CHICAGO BANK DISCUSSES FREIGHT RATES

The National City Bank of Chicago, in its November financial and business letter, discusses the freight rate situation. The letter says:

There is strong probability that the railroads will be permitted to increase freight rates. At any rate, the present application before the Interstate Commerce Commission has the force of very interesting figures cov-

ering net revenues in August. These showed a falling off in net revenues as compared with August, 1916, of \$8,000,000. The extent of this decline is emphasized by the fact that in this period there was an actual increase in gross income of \$38,000,000. The gross revenues of all roads during August showed an increase for the year of about thirteen per cent., while the increase in operating expenses was more than twenty per cent. It is significant that the western roads showed an increase in gross revenues during August of less than \$11,000,000, the total net operating income, after deduction for tax, standing at \$44,626,107, a compared with \$48,926,675 in August, 1916. Inasmuch as the Interstate Commerce Commission, when a few months ago denying the application for the fifteen per cent. increase, promised to review the situation again should conditions justify such action it seems that the necessary relief should be granted. The roads are rendering the government the most efficient service, and because of the immense volume of business now offering, it is essential that the carriers should no longer be expected to furnish transportation at the rates fixed many months ago, when supplies could be purchased for twenty-five to one hundred per cent. less than the quotations prevailing to-day. Current wages and salaries are fully twenty per cent. over those prevailing two years ago. The trainmen and conductors will make new demands for increased wages from December 1 next and it is evident that the roads will be otherwise subject to demands for increased pay.

CHICAGO BANK ON PRICE PSYCHOLOGY

The National Bank of the Republic of Chicago, in its November business and financial letter, speaks regarding price psychology as follows:



Christmas 1917

This Christmas has unusual significance. We have entered a great war to uphold the brotherhood of man; to bring about a righteous peace. Throughout the New Year may we, individually and as a Nation, give the broadest of service to others.

Collins Publicity Service
Philadelphia Penna.



The world is becoming accustomed to having time-honored economic principles set at naught by the exigencies of war. The general opposition to governmental price-fixing and the apprehension that such regulated prices would prove a burden are but the natural consequences of the long period of

INDUSTRIAL TRUST COMPANY

: PROVIDENCE, R. I.

Assets over . . . \$70,000,000

SAMUEL P. COLT, Chairman of the Board of Directors

		H. MARTIN BROWN, President	
JOSHUA M. ADDEMAN	- Vice-President	HENRY B. CONGDON	- Secretary
JAMES M. SCOTT	- Vice-President	J. CUNLIFFE BULLOCK	- Trust Officer
FRANK C. NICHOLS	- Vice-President	ELMER F. SEABURY	- Assistant Treasurer
SAMUEL M. NICHOLSON	- Vice-President	HARRY C. OWEN	- Assistant Secretary
WARD E. SMITH	- Treasurer	HENRY C. JACKSON	- Assistant Secretary

HYDRO-CRETE

TRADE MARK

A NEW CONCRETE FOR BANK VAULTS

PRACTICALLY

FIRE, WATER AND BURGLAR PROOF

VAULTS INSTALLED AND UNDER CONTRACT

Federal Reserve Bank	- - - -	New York City
Guaranty Trust Company	- - - -	"
Metropolitan Life Insurance Company	- - - -	"
Sixty Liberty Street Corporation	- - - -	"
Rhode Island Hospital Trust Company		Providence, R. I.

BY THE

HYDROLITHIC WATERPROOFING CO., Inc.

1328 Broadway

NEW YORK CITY



ESTABLISHED 1865

PEIRCE SCHOOL

OF BUSINESS ADMINISTRATION

Pine Street, West of Broad

PHILADELPHIA

A Business Course, including banking, accounting, business management, commercial law and other practical subjects, which forms an admirable substitute for a college education and saves from two to three years of time.

Special Courses in banking and business administration for students who have had one or more years in college.

Secretarial Courses for those desiring to prepare themselves for secretarial work.

The school is known throughout the United States for the excellence and thoroughness of its business training. Its graduating classes have been addressed by ex-Presidents Taft, Roosevelt, Harrison and Cleveland.

One of the best school buildings in the country; large gymnasium.

Students may enter at any time during the school year.

Fifty-second Catalogue and Illustrated Booklet will be mailed upon application.

rapidly rising prices, and perhaps can be accounted for on psychological rather than material grounds. Compared with pre-war times, profits have been abnormally large, understress of an insistent and insatiable demand from Europe for goods of every description, prices became of secondary consideration. Looking backward, in the case of but few commodities have statistics been conclusive in explaining the enhancement of prices. Commodity prices in the main seem to have reflected a state of mind on the part of the great majority of producers, rather than such considerations as costs or reasonable profits. The psychology of prices is best exemplified in the stock market. Just as an important advance in a leading stock produces a sympathetic rise in the rest of the market, so the rapidly advancing prices of copper, steel, spelter, wheat, cotton and other materials needed by Europe exerted a strengthening influence on the whole price structure. The country had become accustomed to the idea that high prices must continue; therefore, it was not unnatural that, apart from patriotic considerations, any efforts to reduce prospective profits should be viewed with conscious or unconscious resentment.

BECOMES PRESIDENT CHAMBER OF COMMERCE

Richard S. Hawkes, vice-president of the Third National Bank of St. Louis, recently was elected president of the St. Louis Chamber of Commerce. Acting in this capacity he will succeed J. L. Davis, who has been appointed managing director of the alien property bureau at Washington. Mr. Hawkes is a well-known man in banking circles and for the past five consecutive terms has been vice-president of the Chamber of Commerce.

Do you know how Georgia inheritance laws provide for your mother?



If you are unmarried, and die without lines! Legonists, and without making a will, your mother will inherit nothing from your estate if your father is living. If your father is dead your mother will inherit only the same amount a brother or sister receives—even a half-brother or half-sister on your father's side.

Are they entitled to inherit from you as much as your mother, to whom you owe so much of your success?

Should you not protect her against every contingency by having your lawyer carefully draw a will, providing for her interests?

The Atlanta Trust Company, as executor or trustee, will see that the provisions of your will are faithfully carried out, and will relieve her of all worry in connection with managing the estate.

ATLANTA TRUST COMPANY
140 Peachtree Street

An advertisement
prepared by
EDWIN BIRD WILSON, Inc.
Financial Advertising
Bankers Trust Building
NEW YORK

ARKANSAS REPRESENTATIVE FOR MISSISSIPPI VALLEY TRUST CO.

The appointment of Mr. Guy C. Philips as Arkansas representative for

DJÖRUP & McARDLE

Bank, Commercial, and Foreign
Exchange Audits and Systems

42 BROADWAY **NEW YORK**



MODERN BANK BUILDING RECENTLY COMPLETED IN BROCKTON, MASS., FOR THE BROCKTON NATIONAL BANK

THOMAS M. JAMES
ARCHITECT

185 DEVONSHIRE STREET.
BOSTON, MASS.

the Mississippi Valley Trust Company of St. Louis has been announced.

This is the first state representative appointed by the Trust Company and signalizes an intensive cultivation which it intends to make of the Arkansas banking field.

Mr. Philips is a native Arkansan and all his business life has been spent in Arkansas banking circles.



GUY C. PHILIPS
Arkansas Representative Mississippi Valley Trust Company, St. Louis, Mo.

*The Liberty
Tower
Book Shop*

to serve Bankers, Lawyers and Business Firms in the Wall Street district, has been opened on the ground floor of 55 Liberty Street.

This is a real book shop. People who know about books will serve you. You are invited to visit us.

Conducted by
Doubleday, Page & Company

1865



1917

Established Over Half Century

Furs for Christmas

Useful Gifts of Practical Utility are always Appreciated

Our assortment includes everything
fashionable for the Holidays in

**Coats, Capes, Evening Wraps,
Scarfs and Muffs**

IN OUR MEN'S DEPARTMENT

We have a great variety in

Men's Fur and Fur-Lined Coats

Cloth Coats, silk lined, with Fur Collars

ALSO

Caps, Gloves — Rugs and Robes

C. C. Shayne & Co.

Manufacturers of

Strictly Reliable Furs

126 West 42d Street, New York



C. H. CHASE

Asst. Cashier Mechanics American National Bank,
St. Louis, Mo.



RICHARD L. KING

Asst. Cashier Mechanics American National Bank,
St. Louis, Mo.

He has been connected successively with the Bank of Springdale, Springdale, Ark.; the First National Bank of Fort Smith, the Arkansas National Bank at Fayetteville, where he was assistant cashier, and the Citizens Bank

of Fayetteville, where he held the post of cashier.

When Arkansas' first banking law went into effect in January, 1914, Mr. Philips was appointed one of the three bank examiners, whose offices were created under it, and is resigning this position with the State Banking Department to take care of the Mississippi Valley Trust Company's Arkansas business.

His home is at Fayetteville, Arkansas, but practically all of his time will be spent in visits to bankers, which will cover the entire state.

Accurate News of Pacific Northwest

Have You Business or Investment Interests in Washington, Oregon, Montana, Idaho, Alaska or British Columbia?

The authoritative commercial and financial publication of this section is **BUSINESS CHRONICLE OF THE PACIFIC NORTHWEST** issued every Saturday Morning. It tells what you need to know of banking, investments, lumber, fish, apples, agricultural products, mining, foreign trade, railway and marine transportation, commercial and business affairs generally, and analyzes current progress and development. You may rely upon what you see in its columns.

Send for free sample copy. There is no paper like it anywhere.

BUSINESS CHRONICLE

EDWIN SELVIN, Editor

Alaska Building SEATTLE, U. S. A.

NEW MECHANICS-AMERICAN OFFICIALS

The Mechanics-American National Bank of St. Louis announces the election of C. H. Chase and Richard L. King as assistant cashiers. Mr. Chase for many years was manager of the transit department of this bank and his

ADRIAN H. MULLER & SON

55 WILLIAM STREET, Corner of Pine Street, NEW YORK

AUCTIONEERS

The Business of Banks, Bankers, Investors and Dealers in Securities generally, receives prompt and careful attention.

STOCKS AND BONDS AT AUCTION

REGULAR AUCTION SALES OF ALL CLASSES OF STOCKS AND BONDS EVERY WEDNESDAY

Real Estate at Public and Private Sale

Prompt Returns on all business entrusted to us



W. B. COWEN

Vice-President National Bank of Commerce,
St. Louis, Mo.

knowledge of handling the accounts of bank correspondents will be of value in the desire of the bank to give the best possible service.

Mr. King has been connected with the American Exchange Bank and with the Mechanics-American National Bank for the last twenty years, and has held various positions, from that of messenger to teller.

LONG BANKING SERVICE

W. B. Cowen, senior vice-president of the National Bank of Commerce in St. Louis, is now in the fortieth year of his service with that institution. He began his career as a messenger and

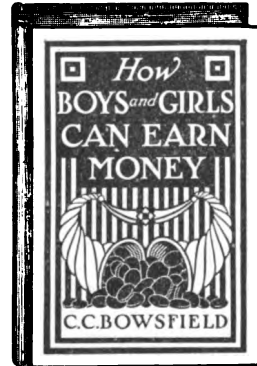

THE banker will find this book of great usefulness in getting up a practical thrift campaign for girls and boys.

Price \$1.15 postpaid

Bankers Publishing Co.
253 Broadway - New York

Ask Your Stationer for
Bankers Linen and Bankers Linen Bond

Made in Flat Papers, Typewriter Papers and Envelopes

They are fully appreciated by the discriminating banker desiring high-grade serviceable paper for correspondence and typewriter purposes

SOLE AGENTS

F. W. ANDERSON & CO.

INCORPORATED

34 Beekman Street, New York

has advanced to his present position through the various official stations. His advancement has been due to a pleasing disposition and to a thorough knowledge of his duties. He has been vice-president of the National Bank of Commerce since 1908.



F. H. STALEY

National Bank of Commerce, St. Louis, Mo.

F. H. STALEY HONORED

F. H. Staley, who is associated with the National Bank of Commerce in St. Louis, and who has shown remarkable

energy and capacity in his position, was recently elected treasurer of the Advertising Club of St. Louis—a deserved recognition of the intelligent and effective work he has done in promoting sound financial advertising and generally advancing the interests of his institution.

DETROIT BANKS IN FEDERAL RESERVE

The Central Savings Bank of Detroit has made application to become a member of the Federal Reserve System. Other Detroit banks which have recently made application for membership are:

The Wayne County and Home Savings Bank, the Peninsular State Bank, the Dime Savings Bank and the Highland Park State Bank of Highland Park. The Peoples State Bank is already a member of the federal system.

The last published statement of the Central Savings Bank shows total resources of \$11,907,931.76 on September 11 last, with savings deposits aggregating \$8,347,273.73 and commercial deposits of \$2,746,020.07.

BANKS ORGANIZED, FINANCED, BOUGHT AND SOLD, everywhere; ample funds always on hand for good new, or old dividend paying bank stocks, carrying official positions. Highest class, confidential selling and buying service rendered banks, bankers and investors. JOHN P. JONES, Monadnock Block, Chicago, Ill.

Princeton University Library



32101 067946879



